

# The **NASA** Journal

VOLUME XLVIII NUMBER 11

NOVEMBER 2008

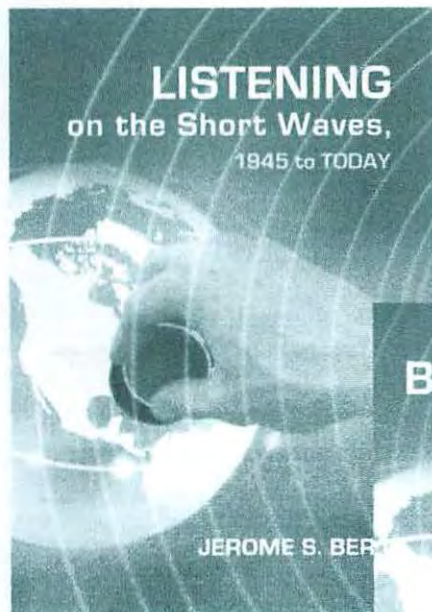

Listening on the  
Short Waves,  
1945 to Today.

*by Jerry Berg*

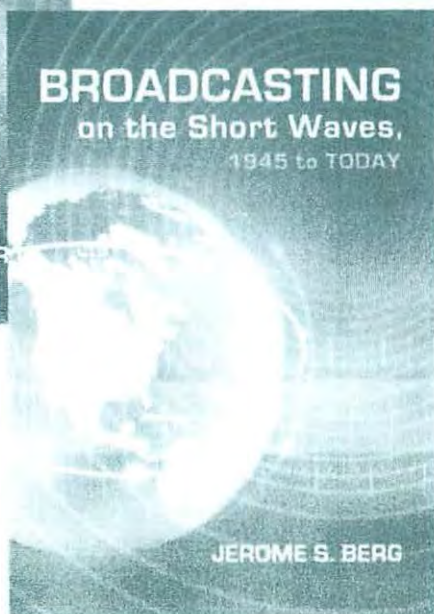

Broadcasting on  
the Short Waves,  
1945 to Today.

*by Jerry Berg*

# Fall Book Sale 2008



**PASSPORT TO WORLD BAND RADIO 2009**  
By Larry Magne. A *must have* book for every worldband listener. Here is everything you need to know about when and where to hear the world, hour by hour, country by country and frequency by frequency. Also includes candid, hard hitting reviews on worldband radios including portables and tabletop models. An expanded station address section is also featured. *Passport* is the world's number one selling shortwave guide. An indispensable reference with 528 pages!

Save over \$4!

New 2009 Edition  
Order #1009 .....\$2.95 \$18.90



**50 YEARS OF AMATEUR RADIO INNOVATION 1930-1980**

By Joe Veras, K9OCO. This guided tour of more than 400 legendary radios from 1930 to 1980, depicts the Golden Age of American radio technology. Each truly beautiful photograph by Joe Veras, K9OCO, includes a brief description, the year the radio was introduced and its selling price at the time. Many of the radios and accessories are quite rare, others are sure to bring fond memories. ©2008 A.R.R.L. 128 p.

Order #3269 .....\$39.95

Companion CD with more photos & info.  
Order #1443 .....\$19.95



**ZENITH TRANS-OCEANIC THE ROYALTY OF SHORTWAVE**

By J. Bryant & H. Cones. Here is the untold story of the world's most romantic and expensive series of portable radios. With a wealth of photographs, ads and documents, the authors tell the engrossing story of the 40 year history of this famous line of radios. Expanded Second Edition. ©2008 Schiffer. 176 p. List \$34.95.

Order #5144 .....\$29.95



**KING OF THE SATELLITES SIX FIVE O**

By Thomas Baier. Clearly the famous 650, was the "king" of the Satellite line. Author Baier, draws from his sources in Germany to cover this famous receiver. Over 100 pictures are featured in this 80 page book. Learn about variants, production numbers, disassembly, adjustments, bulb replacement and much more. The *Owner's Manual* and circuit schematic are also fully reproduced. A great reference for anyone lucky enough to own a 650.

Order #0650 .....\$19.95



**SHORTWAVE LISTENING GUIDEBOOK**

By Harry Helms. Here is understandable information on: selecting and operating a shortwave receiver, antennas, time stations, pirates and much more. With informative tables and diagrams. This noted author gives you a solid understanding of shortwave radio. ©1993 Second Edition 321 p.

Order #2984 .....\$49.95 \$17.90



**WORLD RADIO TV HANDBOOK 2009**

This long established publication is filled with schedules, frequencies and addresses of shortwave broadcast stations. Organized primarily by country. Also includes a by-frequency listing of shortwave broadcast stations, radio club info., plus receiver reviews. *WRTH* Pub. 2009 63<sup>rd</sup> Edition.

Order #3009 .....\$4.95 \$29.90



**WORLDWIDE LISTENING GUIDE**

By J. Figliozzi. Modeled on the author's popular *Worldwide Shortwave Listening Guide*, this new book covers all of today's formats: live on-demand, podcast, satellite, Internet, digital, analog, AM, FM, shortwave and wi-fi. A comprehensive guide to what can be heard how, where and when! Spiral bound. 112 p. ©2008.

Order #0275 .....\$24.95



**BROADCASTING ON THE SHORTWAVES 1945 TO TODAY**

By Jerome S. Berg. The heart of the book, *Shortwave Year-by-Year* is a detailed account of the shortwave bands in each year from 1945 to present. It reviews what American listeners were hearing on the shortwave bands, describes the arrival and departure of stations, and recounts important shortwave events.

©2008 McFarland 384 p. List \$65.00.  
Order #2549 .....\$59.95



**LISTENING ON THE SHORTWAVES 1945 TO TODAY**

By Jerome S. Berg. Written from the standpoint of the serious shortwave enthusiast, this book examines the histories of the major North American shortwave clubs, DX programs, a chronology of the shortwave receivers, how receiver technology impacted listening plus PCs and shortwave listening. ©2008 McFarland 424 p. List price \$65.00.

Order #1651 .....\$59.95

**2009 ARRL HANDBOOK FOR RADIO COMMUNICATIONS**

This massive 2 inch thick volume is the ultimate reference book for hams and techs. For all skill levels. With CD+V. B6" Ed. ©2008 A.R.R.L. Softcover 1200 p. List \$44.95.

Order #5187 .....\$99.95 \$34.90

**2008 ARRL HANDBOOK FOR RADIO COMMUNICATIONS**

The 2008 59<sup>th</sup> Ed. with CD. Closeout.

Order #5024 .....\$44.95 \$22.98

**DISCOVER DXING HOW TO HEAR DISTANT AM, FM & TV STATIONS**

By J. Zondio. A great intro to DXing the AM, FM and TV bands. Topics include: propagation, seasonal conditions, equipment, antennas and reference materials. Third Ed. ©2006 Universal Radio. 96 p.

Order #0003 .....\$6.95



**UNIVERSAL CATALOG 08-08**

This informative, new 124 page catalog was printed October 2008. It features a wide assortment of items for the shortwave, amateur and scanner radio hobbyists. It is not being sent out automatically, so request your **FREE** copy by phone or email today!

**Universal Radio, Inc.**  
6830 Americana Pkwy.  
Reynoldsburg, OH 43068  
800 431-3939 Orders & Prices  
614 866-4267 Information  
614 866-2339 FAX  
dx@universal-radio.com  
www.universal-radio.com

Prices and specs are subject to change.  
Universal buys radio equipment. Call.  
Returns are subject to a 15% restock fee.

**www.universal-radio.com**

Guaranteed lowest prices on the web?

Not always. But we *DO* guarantee that you will find our website the most informative.

Please stop by for a look. We offer a wide selection of new and used shortwave equipment, antennas and books.

★ U.S.A. flat-rate shipping: Under \$50-\$9.95,  
\$50-\$100-\$7.95, \$100-\$500-\$9.95, \$500-\$1000-\$14.95.

Except Alaska, Hawaii and Puerto Rico.

**universal radio inc.**

Quality Communications  
Equipment Since 1942

Jerry Berg has done it again and since once more wasn't enough, he did it twice more. JB—long time active club member, former editor, current Executive Council member, world renowned DXer and internationally acclaimed author—has written two new books once again published by McFarland & Company in Jefferson, North Carolina. He has penned two very interesting books about our hobby that essentially pick up where the original *On the Short Waves, 1923-1945: Broadcast Listening in the Pioneer Days of Radio* left off. First is *Listening on the Short Waves, 1945 to Today* (hardback, 415 pages, 120 photos, ISBN 978-0-7864-3996-6) which begins with an examination of the broad shortwave audience. It then presents in detail the histories of the major North American shortwave clubs (NASWA is prominently featured), and reviews the professional and listener-generated shortwave literature of the era. It also covers the DX programs and other listening fare to which shortwave listeners were most attracted, and the QSL cards they sought as confirmation of their reception. The other excellent title is *Broadcasting on the Short Waves, 1945 to Today* (hardback, 488 pages, 190 photos, ISBN 978-0-7864-3674-3). This book focuses on the stations and the environment in which they operated. It contains a detailed account of the shortwave bands for each year from 1945 to the present. Written from the standpoint of the listener, it reviews what American listeners were hearing on both the international and domestic shortwave bands, describes the arrivals and departures of stations, and recounts important shortwave events. Both books are available from the publisher, McFarland & Co., Inc., Box 611, Jefferson, NC 28640, by mail, phone, FAX or on the web. See the McFarland website [www.mcfarland-pub.com](http://www.mcfarland-pub.com) for details. They are also available from Universal Radio in Reynoldsburg, Ohio,

and from major Internet booksellers such as Amazon, Barnes & Noble, and Waterstone's. Each title lists for US\$59.95 plus shipping. I plan to have a book review or two in the next month's *Shortwave Center*. Members are encouraged to write a review for Shortwave Center or contribute their thoughts about these books—or any other hobby related books—in the Musings section of *The Journal*.

Congratulations to our own **Dr. Mark J Ferrioli** for a job well done representing the club at the semi-annual Kutztown Antique Radio Meeting. We have complete coverage of the event in the words of Dr. Mark (article in Shortwave Center) and **Rich Parker** (Musings) who attended on both days. Thanks to Mark's efforts the club netted some new members, distributed sample bulletins and helped develop a nice working relationship with Popular Communications. For a while, it appeared to be another chapter meeting of the Reading Area DXers with **Ed Mauger** and **Ron Hunsicker** also attending the event. The reports I have seen and heard indicate a great time was had by all and it was a very successful event for the club. Thanks Mark for you take charge approach to the event and making it happen. Nice!

On a sad note, we learned of the passing of long time club members and former *Flash-sheet* editor, **Ray Bauernhuber**. His niece, Kelly Haiduk, sent word as did a few DXers who knew Ray. In his niece's words: "It is with sad news that I must inform you my Uncle Ray has passed away. On Thursday 9/25 he had a massive heart attack at home around 4:30 p.m. I know from all of the people that are on his e-mail list you were very dear friends to him. If anyone should require further information, please do not hesitate to contact me. I am Ray's niece, Kelly. I am sorry that it took so long to inform everyone, my Aunt Pat needed

---

## Our Motto: Unity & Friendship

to find his password for us to let everyone know. My e-mail address is : bqkelly@optonline.net. Regards Kelly Haiduk." Condolences, I think, can be sent to his niece at the above e-mail address. I have already sent condolences on behalf of the club.

**Gayle and Larry Van Horn** have announced the release of Teak Publishing's second eBook, the *International Callsign Handbook, 2nd edition*. Written by Gayle and Larry, the new CD-ROM publication will aid radio hobbyists in identifying radio stations in the HF/VHF/UHF radio spectrums. The *International Callsign Handbook* is a concise world directory of various types of radio station identifications covering military, government, maritime, aeronautical, and fixed radio stations on CD-ROM. The disk contains thousands of callsigns and other types of identifiers from Gayle and Larry's personal log book, official sources and dedicated hobbyists who contributed material. The *International Callsign Handbook* is published in Adobe Acrobat (PDF) electronic format and is fully searchable and printable. If you want to identify who you are hearing on your radio, then this book should be on your radio shack shelf. The handbook is 1,414 pages and costs US\$19.95 plus US\$3.00 shipping and handling. Contact Teak Publishing, P. O. Box 297, Brasstown, NC 28902, USA or e-mail at teakpub@brmemc.net for further information.

**Robert Kipp**, who helped get Radio St. Helena back on shortwave and has been instrumental in obtaining QSLs, has devised a method he hopes will facilitate QSL responses from the station for those listeners that have had problems with mail service. "Due to the recent flood of emails from DXers (mostly in USA) asking about their RSD 2007 reception reports and QSL cards that have not arrived, I have written a new "standard reply text", which I am now sending to everyone asking me about their QSL problems. PLEASE pass this information to radio clubs, radio blogs, radio newsgroups, and all DXers with similar questions for Radio St. Helena. Radio St. Helena: Procedure for Handling QSL Problems: Regarding your problem with your RSD 2007 QSL card, I would suggest the following. PLEASE send RSH a copy of your reception report by email. PLEASE tell

them what you included inside the envelope to pay for return postage and anything else that you included (as souvenirs, used stamps, pictures). PLEASE tell them whether you had several special / very pretty stamps on the outside of the envelope which might have attracted special "attention" at some post office along the way to St. Helena. RSH will then TRY to find your report and TRY to issue you a QSL. Send your email(s) to: radio.sthelena@helanta.sh. Write in the "Concerning" area of the email title: RSH Office : RSD 2007 QSL Problem (your family name) (your country name). Example : RSH Office : RSD 2007 QSL Problem Kipp Germany. If you wish, you might send me a COPY of your emails to Radio St. Helena. That way I can follow the situation. Thanks and with best greetings from Germany, Robert Kipp, ZD7PU." Robert's e-mail address is RDC-Roberts-Data@t-online.de. In recent weeks, a number of "missing" QSLs have been arriving in the USA and Canada thanks to Robert's efforts in the past. Hopefully, this situation will continue to get better as we approach another broadcast.

Although not shortwave broadcast, many long time members might be interested in an interview **Bob Zanotti** did with Bob Thomann ("The Two Bob's" of Swiss Radio International fame in honor of the latter's 80th birthday. They discuss Thomann's early days in radio as well as his amateur and professional radio activities including his technical involvement with Nexus-IRRS. The audio can be heard only online at the Switzerland In Sound website (www.switzerlandinsound.com) that Bob Zanotti operates. It will be a permanent feature under "The Two Bobs" tab at the website. Although this should be of interest to any shortwave listener, I think that those of us that recall listening to these two gents on air will especially enjoy the interview.

**Bob Padula** announced that the ASWG Edition 22 of the *Australian Shortwave Guide* (ASWG-22) is available. It is a no-frills reference, covering the five-month international shortwave transmission period commencing October 26 2008, and concluding on March 29 2009, known as the "B08 International Transmission Season." With several hundred entries, it provides comprehensive informa-

tion of shortwave broadcasting schedules for transmissions intended for Australia, New Zealand and the Pacific Islands, for broadcasts in all languages. The complete schedules for Radio Australia and CVC-Australia are also included. The ASWG has been around for 26 years was first published in 1982 as a supplement to an early Australian commercial electronics magazine. Proceeds from sales assist with costs of internet research, marketing, printing, packaging and mailing. Orders from outside Australia cost US\$10.00 / 10 Euro / 6 British Pounds / A\$10.00 - cash, five international reply coupons, Australian mint stamps to the value of A\$10, international bank transfer, international bank draft, or PayPal. Cash payment in any other currency is acceptable, to the equivalent of AUS\$10.00. Orders and payments should be sent to: Robert J. Padula, 404 Mont Albert Road, Mont Albert, Victoria 3127, Australia. Please use this E-mail address when ordering through PayPal: bobpadula@mydesk.net.au. Advise Bob of your name and address details. Online ordering via PayPal is encouraged and there is a direct PayPal Link at the home page of the EDXP (<http://edxp.org>).

There is still time to get those Radio Free Asia (RFA) special 12th anniversary that our friend **A. J. Janitschek** of RFA announced last month. The first RFA broadcast was in Mandarin on September 29, 1996 at 2100 UTC. Card 1 was used for all valid reception reports dated Sep 1-30, 08 and card 2 was used for all valid reception reports dated Oct 1-31, 08. For November, card 3 will be used for all valid reception reports. The designs used are examples of many drawings made by the children of RFA personnel earlier this year and were inspired by the work their parents create daily at RFA. More information about Radio Free Asia, including the current broadcast frequency schedule, is available at [www.rfa.org](http://www.rfa.org). RFA encourages listeners to submit reception reports. Reception reports are valuable to RFA as they help the station evaluate the signal strength and quality of their transmissions. RFA confirms all accurate reception reports by mailing a QSL card to the listener. RFA welcomes all reception report submissions at [www.techweb.rfa.org](http://www.techweb.rfa.org) (follow the QSL REPORTS link) not only from DX'ers, but also from

its general listening audience. Reception reports are also accepted by email to [qsl@rfa.org](mailto:qsl@rfa.org), and for anyone without Internet access, reception reports can be mailed to: Reception Reports, Radio Free Asia, 2025 M. Street NW, Suite 300, Washington DC 20036, USA. Upon request, RFA will also send a copy of the current broadcast schedule and a station sticker.

Here is another reminder from **Jeff White**, President of the National Association of Shortwave Broadcasters (NASB) about the next NASB—Digital Radio Mondiale (DRM) USA Annual Meeting which will take place in Nashville, Tennessee 7 and 8 May 2009 at the Holiday Inn Express in downtown Nashville. Shortwave broadcasters, shortwave listeners, equipment manufacturers, consultants and anyone with an interest in shortwave radio are invited to take part. There is no cost to attend; you only need to pay your own travel and hotel expenses. While the two days of meetings are primarily for personnel from shortwave stations, transmitter and antenna manufacturers, consultants, etc., there are many talks and activities which will be of interest to SWLs and DXers as well, such as the tour to WWCR and World Christian Broadcasting, a panel discussion about the state of shortwave listening and broadcasting in Europe, a presentation about the new shortwave station Madagascar World Voice, etc. These two-day meetings are very interesting affairs based on my own personal experience. This is an excellent opportunity to hear, learn and discuss issues with shortwave broadcasters, shortwave listeners, equipment manufacturers, consultants, or anyone with an interest in shortwave radio.

Please remember to direct all communications about subscriptions, bulletin delivery issues, Thanksgiving holiday tips, the use of PayPal as a payment method, etc. to **Bill Oliver** at the club's Levittown address or to his new electronic address, [billoliver@verizon.net](mailto:billoliver@verizon.net). The regular postal address is the familiar 45 Wildflower Road, Levittown, PA 19057. Inquires sent to Wyomissing only slow down the process. Thanks!

That's it for this month. Enjoy this month's edition of the *Journal*; it's another good one. 

## NASWA Flashsheet

Are you getting the latest hot information about what is happening on the shortwave bands? If you have not signed up for the club's electronic *Flashsheet* service, you are missing out on timely news and information about the DX scene that will enhance your shortwave listening pleasure. If you are a current member of the club and want to receive the electronic Flashsheet just drop **Rich D'Angelo** (rdangelo3@aol.com) a note with your e-mail address, location and membership expiration date from your mailing label. You can participate by sending your latest logs to the electronic *Flashsheet* edited by **Mark Taylor**, markokpik@tds.net. The club's electronic *Flashsheet* helps members stay on top of the action with breaking shortwave news and information. The electronic newsletter is an excellent supplement to the monthly *Journal* for the timely dissemination of DX loggings and breaking news.

## NASWA Yahoo Group

Join moderator **Dan Ferguson**, the club's Yahoo Group, and other club members to discuss reception of shortwave radio broadcasts, program content, propagation, reception conditions, loggings, hot news and information as well as radio equipment and accessories and any topics related to shortwave radio in general. Please keep in mind that loggings, QSL news, schedule changes should also be reported to the appropriate column editor of the *Journal* for publication. This forum is a supplement to, not a replacement of, *The Journal*. Subscribe by going to <http://groups.yahoo.com/group/NASWA/>.

---

## FRENDX: Twenty-Five Years Ago (November 1983)

The cover of *Frendx* features Roger Legge with ANARC's North American DXer of the Year for 1983 award for his many years of work with the UHN bulletin about Soviet radio transmissions. In Headquarters, Bill Olive noted that The Old Dominion DX Association published its first bulletin and is looking for support. Bill Krause of the ANARC Computer Information Committee was interested in hearing from hobbyists that used a computer in any manner. In John Herkimer's Shortwave Center, Bill Sparks wrote the definitive article entitled "DXing the Indonesian Radio Countries." Bill Taylor says goodbye in his Vintage Vignettes column. In his Technical Topics column, Jim Herkimer wrote about grounding techniques. John Campbell wrote "Procedural vs. Declarative Computing: What, Me Worry?" In his QSL Report column, San Barto featured illustration from Africa with 105 countries reported as verified for the month. In Log Report A, editor Mike Nikolich noted that there was a new Costa Rican on 4,825 kHz and reported reception of Djibouti on 4,780 kHz. In Log Report B, editor Jerry Berg noted new Nigerian Educational Service on 4,932 kHz. In Log Reporters, Nick Pappas noted that 59 members contributed while asking members to please cut log submissions into strips for distribution to the editors. 

---

---

## Calendar Of Events

- Nov 12 Awards. The Association of International Broadcasters awards gala** will be held in London, England with the presentation of international television and radio awards. AIB Media Excellence Awards and Diner Pensant LSO St. Luke's, 161 Old Street, London EC1V 9NG. The cost of each place at the Dinner at the early-bird rate (valid to 30 June 2008) is £175 plus UK VAT @ 17.5% (£30.62), giving a total cost of £205.62 per place.
- Nov 14 Meeting. Boston Area NASWA Chapter.** The Boston Area DXers have found a new location for meetings. Inquiries about the BADXers may be sent to Paul Graveline at 978-470-1971 or Internet: [ctreditor@aol.com](mailto:ctreditor@aol.com). The URL for the BADX guys is <http://www.naswa.net/badx/>
- Nov 15 Meeting. The Columbus, Ohio NASWA Chapter** will be meeting at Universal Radio in Reynoldsburg at 10:00 AM. Further information is available from Mike Rohde at 614-527-1398 or via e-mail at [merohde@columbus.rr.com](mailto:merohde@columbus.rr.com). The purpose will be to gather other SWL/ DX listening enthusiasts together for informative discussions and sharing of knowledge and information about the hobby.
- Nov 15 Meeting. The Cincinnati/Dayton Monitoring Exchange (MONIX)** meets at the Lebanon Citizens' National Bank (LCNB), 425 West Central Avenue (Ohio 73), Springboro, Ohio at 7:00 PM. For more information contact Mark Meece at 937-743-8089 or e-mail at [antennapig@siscom.net](mailto:antennapig@siscom.net). For additional information about MONIX, check out their web site at <http://www.siscom.net/~mmeece/monix.html>
- Nov 17 Meeting. Tar Heel Scanner/Shortwave Listening Group.** Red, Hot and Blue restaurant, 6615 Falls of the Neuse Rd., Raleigh, NC. Dinner @ 6:30PM, meeting @ 7:30PM. Meetings the 3<sup>rd</sup> Monday of each month. Info, Curt Phillips, 919-773-4522, <mailto:curt@nerdster.net>
- Nov 21 Meeting. The Reading Area DXers** will hold another meeting at The Flying Dog in majestic Earlville, PA (Route 562 and Airport Road). Members gather around 5:30 PM near the bar area before heading into the restaurant for dinner and further discussions. Contact Rich D'Angelo (2216 Burkey Drive, Wyomissing, PA 19610; 610-678-0937; [rdangelo3@aol.com](mailto:rdangelo3@aol.com)) for further information about future meetings.
- Nov 22 Meeting. Reading International Radio Group** will hold its next meeting on Saturday October 4 at 2:30 PM in Room 3, Reading International Solidarity Centre, 35-39 London Street, Reading. All are welcome, for further details email Mike Barraclough [mikewb@dircon.co.uk](mailto:mikewb@dircon.co.uk) or phone 01462 643899.
- Mar 13-14, 2009 Convention.** The 22<sup>nd</sup> Annual Winter SWL Festival, sponsored by NASWA, will be held at the Best Western—The Inn at Towamencin on 13<sup>th</sup> and 14<sup>th</sup> March 2009. Richard Cuff and John Figliozzi co-chair the organizational committee. Although it is early, you don't want to miss this special Fest event. See you there!
- May'09 Annual Meeting.** The 2009 National Association of Shortwave Broadcasters and US DRM Group will be held in Nashville, TN 7 and 8 May 2009. It will be co-hosted by World Christian Broadcasting and WWCRC. Additional information will be available at a later date.
- May'09 Annual General Meeting (AGM) and DX Camp. The Danish Shortwave Club International** will hold its AGM and DX Camp from May 11<sup>th</sup> through May 17<sup>th</sup> at Vardeborg, Vejers Beach, Denmark. For further information contact Bent Nielsen ([bent.elin@webnetmail.dk](mailto:bent.elin@webnetmail.dk)), Egekrogen 14, DK-3500 Værloese, Denmark. More information will be available later on.

**Mar'10** *Convention.* The **23<sup>rd</sup> Annual Winter SWL Festival**, sponsored by NASWA, will be held at the Best Western—The Inn at Towamencin on 5 and 6 March 2010. Richard Cuff and John Figliozzi co-chair the organizational committee. Although it is early, you don't want to miss this special Fest event. See you there!

**May'10** *Annual Meeting.* The **2010 National Association of Shortwave Broadcasters and US DRM Group** will be held in Hamilton, Ontario on 13 and 14 May 2010. It will be hosted by Galcom International. Additional information will be available at a later date.

Members are invited to submit items to be included in this calendar to Rich D'Angelo (Internet: rdangelo3@aol.com) or Ralph Brandi (Internet: ralph@brandi.org). 

---

## Musings

**Richard W. Parker, KB2DMD, 1205 Sleepy Hollow Road, Pennsburg, PA 18073**

Dateline Geryville, 29 September. It is Friday afternoon. There is a ton of work in my shop that needs to be done. But, the weather is magnificent and the Kutztown Antique Radio Meet is on. It has been 12 years since I've been to a flea market that specializes in musty smelling, broken radios. I say to heck with work, and decide to play hooky instead.

With great circumspection, I ensure that no one is watching while I filch 5 gallons of petrol from our generator shed, dump it into the old Bronco, and then plunder 75 dollars from petty cash. I know from past experience that is enough to net me an R390 or a "Junkson" Valiant. With a bit of haggling, I might even net a decent AR-88, RBC, or GPR-90, and still have enough money left for a hot dog!

A spirit of pure defiance washes over me as I point the old truck toward Kutztown. I am on the road. I feel truly free.

Since Miss Heidi had to work until 8 PM, she was unable to accompany me. So, I brought along the digital camera, so that I could at least provide her with a "virtual" broken radio experience when she got home.

Arriving at Renninger's market, I first made my way to the NASWA booth. Dr. Mark Ferrioli and his lovely girlfriend Linda had set this up, and they did a spectacular job. The club banner was mounted high above, and they had constructed a beautiful display showcasing the SWL hobby. There were stacks of Journal back issues and current issues of Popular Communications, free for the taking. There was also a free raffle, two lucky winners would receive a one year subscription to PopComm. Dr. Mark also made it possible for those interested to join NASWA right on the spot.

After taking a cursory look around the show, I noticed that Ed Mauger and Ron Hunsicker had arrived, so I returned to the NASWA booth to shoot the breeze for a spell. Ed was kind enough to take me around to the various tables where old radio magazines were being sold, and I picked up several copies of Electronics Illustrated and Popular Electronics from the early '60s.

There was a decent selection of tube-type communications receivers at Kutztown, but the asking prices had increased exponentially over the last 10-20 years. To purchase a radio at this meet, I'd have needed four times the amount of money I'd brought, and there probably wouldn't be enough left for that hot dog. Lewie (of Lewie's Oldies") had several of the earlier Hammarlund HQ-series receivers, and they were fairly clean. There was also a HallicrafterSX-24 Skyriider Defiant that I'd have liked to take home - if it was about \$125 cheaper.

I also saw a Signal Corps AN/GRR-5 (or "Angry-5") receiving set. I gave mine away many years ago, and still kick myself over it. The neatest thing about these radios is their ability to run off of either AC mains, 6, 12, or 24-volt DC, or 6 and 90-volt dry batteries. The example at Kutztown, however, was severely trounced and would have elicited a groan from even the most stalwart restorer. The asking price of \$150 seemed about twice what it was worth.

For Miss Heidi's virtual tour, I mainly photographed the beautiful old wooden table radios and floor consoles, and shot quite a few close-ups of the more interesting dials. After viewing the pictures that evening, she was so delighted that she decided to forego sleeping in on her day off, and instead accompanied me back to Kutztown on Saturday morning.

No sooner had we arrived than a "Locks of Love" Nazi took notice of her gorgeous 4-foot long golden tresses, and accosted her for a hair donation. Since this is a rather common occurrence, she is quite used to handling these people. And, despite their often rude and abrupt demeanor, she still donates a foot or so of her hair about every five years.

We had a wonderful time examining the plethora of radios and memorabilia. There were radios by every well known American and foreign manufacturer that you could name, and even a few that I'd never heard of. Most interesting were two full-size "Grandfather clock" radios, a Philco and an Atwater-Kent. The A-K sold quickly, but we agreed that the more common Philco was by far the prettier of the two with its colorful, floral-motif "All-Wave" consoles (with their breathtaking chrome plated chassis), complete with full sets of plug-in band coils. A beautiful Fada TRF receiver seemed fairly priced at \$200, as did a wonderfully restored Zenith "shutterdial" console (which was powered up and running) at \$325.

Among the oddities were a German-made Star "Neptun Ultra" - a behemoth table radio with a "magic eye" tube and a bazillion German cities listed on the dial. This radio actually tempted us, until we noticed a rat's nest of very questionable wiring poking out of the chassis. The cool old advertising (tin and illuminated signs, banners, etc.) added greatly to the nostalgic ambiance, as did several tables of antique "loud talker" speaker horns. Wherever we walked, great old music from the '30s and '40s played from radios, Victrolas, and jukeboxes.

By far the best values to be realized were from the vendors of fully restored table radios and floor consoles, most were priced in the \$200-400 range. Many very interesting '60s vintage solid-state multi-band German portables (by makers like Grundig, Telefunken, and Siemens) were also reasonably priced but, unfortunately, most of them had "issues". Of course, there were also vendors who were completely out of touch with reality, asking insane prices for inferior pieces. Heidi noticed one who actually bordered on thievery - he was selling current "Radio Daze" catalogs (which can be obtained for free) for twenty-five dollars apiece! It would be unfortunate if someone was unwittingly taken in by this bandit.

None of these "rough spots" were able to sully the overall experience, however. Held each year in the spring and fall, the Kutztown Antique Radio Meet is a delightful trip back in time. I highly recommend it.

**Dr. Mark J. Ferrioli <Drmarkjf@AOL.Com>, P. O. Box 5000, Philadelphia, PA 19111**

Another great time of fellowship and radio fun was had by all at the most recent gathering of the 'Berks County, Pennsylvania Based NASWA Meeting Group' (Serving all of S.E. Pennsylvania -- You do not have to live in the area to attend) which was held on Friday night September 26th, 2008, from 05:30 to 08:30 P.M., at the 'Flying Dog' in Earlville, PA! Present were our Executive Director Richard A. D'Angelo, 'Easy Listening' NAWSA Journal Columnist Richard Cuff, Dr. Mark J. Ferrioli, Ron Hunsicker, Ed Mauger, and Mr. Richard W.

Parker. A bit of celebration was in order as this gathering directly followed our successful 'NASWA Membership Drive' which took place the preceding weekend at the 'Antique Radio Show' sponsored by the 'Delaware Valley Historic Radio Club' at 'Renninger's Antique and Farmer's Market' in Kutztown, PA! To be sure there were many congratulatory remarks expressed for everyone's effort and support! Also, during the meeting and dinner at 'The Flying Dog' Mr. Ron Hunsicker brought in an unusual antique 'Ham 20 Radio Call Sign Announcement 10 Minute Timer' which was very unique and Mr. Ed Mauger brought in a collection of some sixty (60) copies of 'Radio News and The Short-Wave' magazines from the 1930's (We even got to borrow a few issues to take home for our personal perusal) in addition to other memorabilia brought in by several of the others present (It seems there is always sometime new for 'Show and Tell')! As always, the food was fantastic as well as the liquid refreshments in what has now become a 'Smoke Free' environment (The place actually smelled a little like flowers)! In short, another enjoyable time was had by all! The only thing missing was YOU! Why not join us on the 4th Friday of every month in the great metropolis of Earlville, PA! Contact our Executive Director Richard A. D'Angelo for further details and directions, etc.

**Joe Wood <joekennethwood@usa.net>, Greenback, TN**

Earlier today, my good friend, Joe Miller, informed me that Ray Bauernhuber had passed away. I just saw on the HCDX site a confirming message.

Ray was a very good friend of mine, and he will be greatly missed. He did a great job editing the NASWA Flashsheet. I always enjoyed swapping emails with him on diverse topics ranging from the standard SW stuff to items as arcane as the Confederate States Navy. Most recently, we discussed the exploits of Nathan Bedford Forrest.

He had had his share of maladies, but he always retained his sense of humor and was always willing to pass along his knowledge to anyone who asked.

I ask that we all remember him and his wife in our thoughts and prayers.

**Jim Ronda <james-ronda@utulsa.edu>, Tulsa, OK**

It is with great regret that I report the death of Ray Bauernhuber. Ray was a long time member of NASWA and editor of Flashsheet before Mark Taylor took over. Ray was devoted to both shortwave and medium wave DXing. He was one of those classic "good guys" and for all of us who knew him he will be sorely missed. Ray was one of the first to welcome me back into the hobby and I mourn his loss.

**Rick Barton <desertmoon\_dxr@yahoo.com>, Phoenix, AZ**

I won't go too long here as I know NASWAs focus is on short wave. I was Looking at "market side" based on my own personal experiences and observations of the PHX market.

When I first wandered out to the southwest and settled in the PHX area (in 1984), one of the top radio stations in town was KOY, 550 kHz., with a popular 1960s DJ, Bill Heywood. that changed quickly as AM listenership fell off. Many AMers dropped music formats or went to FM—some of them simulcasting on their old AM frequencies.

As you can imagine, few who had the choice of listening to high energy dance music on, say, KOPA, were listening on their old 1440 kHz. outlet. They had all gone up to 100.7.

By the late 1980s, it was hard for me to find anyone who even listened to the AM band at all, other than a hard core group of teenage punk rock fans who had glued their tuning knobs to 1060 KUKQ, the station that played the Ramones, the Pixies, the Sidewinders and the like! (that even died when "the Edge"—KEDJ signed on the air on FM a few years

later), so I half expected to see MW perhaps even being phased out somewhere down the road, if what I saw happening locally was the trend nationally. it was THAT bad.

Then Tom Leykis came to town bringing in a bunch of political talk radio hosts from the Atlanta and Miami areas and made a major station out of 910-KFYI (now on 550).

Today, the "AM band" here is big-time, with both political and sports talk shows...ranging from local hosts like Gambo and Ash to syndicated shows like Jim Rome, Dennis Prager, and ...uh...you know, that guy I can't name without creating a firestorm... (he came from Cape Girardeau, MO).

The tie-in to SW here is that the talk radio trend, and the upsurge in ratings for MW listenership here, was unforeseen...and I wonder why SW broadcasters can't see that there could be unforeseen things in radio's future that would make them wish they would have stuck around on SW a little longer. (NOT that I'm any expert).

**Ron Hunsicker <ronhuns@ptd.net>, 1238 Cleveland Avenue, Wyomissing, PA 19610-2102**  
**NEW SUNSPOT:** For the first time in months, a significant sunspot is emerging on the sun. It is a fast-growing active region with two dark cores, each larger than Earth. The magnetic polarity of the sunspot identifies it as a member of new Sunspot Cycle 24. Because the year 2008 has brought so many blank suns, some observers have wondered if we are ever going to climb out of the ongoing deep solar minimum. Today's new sunspot is an encouraging sign that the 11-year solar cycle is indeed progressing, albeit slowly. Visit <http://spaceweather.com> for sunspot photos and updates.

**Toshi Ohtake <ohtaket@yahoo.co.jp>, 5-31-6- Tamanawa, Kamakura 247-0071, Japan**  
The first topic is EDXC 2008 in Finland and Baltic tour afterward. Finland DX Association(FDXA) commemorates its 50th Anniversary this year and hosted EDXC at Vaasa which is 400 km NNW of Helsinki facing the sea. The Conference held on 5-7 of September was attended by more than 110 people from 12 countries. Representatives from Vatican Radio and Voice of Turkey also attended.

Agenda started with the flag ceremony, then International panel featuring the broadcasters, EDXC representatives, the latest SDR radios, AM and FM DX panels and Scandinavian Weekend Radio followed. The bus tour to the Kvarken Archipelago, Finland's first World Natural Heritage was very impressive and enjoyable one.

After the EDXC, Mr. Risto Vahakainu led us to Baltic countries tour. We left Vaasa by train to Helsinki where we spent an hour short walking tour of the city. Then we took 100 minute/80 km ferry to Tallinn, Estonia. Next day on 8 September we had walking tour of Tallinn, then took bus to Riga, Latvia. The city looked like the busiest city among the Baltic countries. The last leg was bus to Vilnius, Lithuania. On our way we stopped at Kaunas where two DXers met us at the bus stop and took us to radio transmitter site. The last day on 10th, we visited Vilnius TV tower with its tragic history in 1991 and had the walking tour of the old town. We all learned a lot about those countries and I appreciate Mr. Risto's detailed planning of the tour.

The second topic is the continuing radio program dedicated to late Koji Yamada who died 19th of August. As mentioned last month many stations aired special program for Mr. Yamada. On 15th of September, Radio Nikkei, Japan's short wave broadcaster, aired 2-hour-long dedicated program to Mr. Yamada, citing his contribution to the Japanese society and the radio world. Mr. Toshi Ohtake of Japan Short Wave Club and Mr. Toru Yamashita of Asian Broadcasting Institute were among the invited guests in studio to show his past life and recent activities. Mr. Yamada's photo is on our cover this month.

This is all for this month.

**Mark Schiefelbein <arcosanza@yahoo.com>, near Ponce de Leon, MO**

After a few months' break from the radio, I've been working on constructing a portable beverage antenna for use on local DXpeditions. I gave it a quick-and-dirty test at a local conservation area this week; since it was unterminated and nowhere near being in a straight line, it was basically a random wire. Nevertheless, it performed better than I had hoped, pulling in LRA36 and 3 separate R Australia-Brandon freqs at mid-afternoon.

Received in the mail today an envelope containing QSLs ("2006 Revival Transmission" and "10th Shortwave Transmission Anniversary") for my 2006 and 2007 reports to Radio St. Helena, both signed by Laura Lawrence, Station Manager. The envelope was postmarked in Jamestown on Aug. 27, so it only took 11 days to get from St. Helena to Missouri—impressive. I was one of those who never heard back from my original report in 2006, so many thanks to Rich D'Angelo and others who helped to organize replacement QSLs. I also never heard from RSH the one previous time I had QSLed them in 1994, so I was beginning to wonder if I was cursed! Received in 10 months/22 months for English reports and \$5 (plus some extra \$ in 2006).

Getting back in the swing of things here...hope to be checking in weekly now that DX season is upon us.

**Kevin Mikell <k.mikell@comcast.net>, Park Ridge, IL**

Played around with DRM a bit. Only put 3 logs in the book... DRM logs seems pointless after a certain point. Here are 2. Likely the only logs I'll ever put in the book. Used my Perseus connected to an external antenna, Dream software, and my laptop.

Things that have already been said: The sound is amazing and knowing it is coming via shortwave is a kick. Ah, but setting it up is a true pain and you need a very strong signal indeed. Sackville seems to be the only thing that comes in recoverable here.

I had to return the Perseus to Universal for a swap out due to a bad power connector on the box.

Put up a new antenna. Shorter and lower, unfortunately, but heading in a slightly different direction. Still just wire in the air anyway. Maybe it will help with local noise.

Was listening to RCI on DRM on 09/24 when they mentioned no more shortwave to Europe. Stated in passing as if nobody in Europe was listening on shortwave anyway.

**Bob Coomler <w6rjc@yahoo.com>, Cloverdale, CA**

In today's mail was a card for the 2006 Radio St. Helena transmission. For those still waiting, there is hope! I know this didn't happen spontaneously, so thanks to all who were involved in making this happen.

**Daniel L. Srebnick <dan@islenet.com>, NJ**

Thanks to NASWA and Robert Kipp, I finally received my Radio St. Helena revival QSL for 2006, almost 2 years after the original air date. Haven't been doing much SWLing, so the QSLs have been few and far between, making this one a real pleasure.

**Gianni Serra <dxe\_gsera@fastwebnet.it > Roma, Italy**

Ciao from Roma.

Few novelty on Tropical Bands during last week of September and the first days of October, all caught with heavy atmospheric statics, giving hard work to my NIR 12 audio filter: on the 60 meters, just appeared again Bolivia with R. San Miguel, then caught usual Brazilian stations (all logged), with a strong R. Clube do Para', and R. Rebelde (not logged). On 90mt band I caught the South African R. Sondergrense, with a weak audio

under strong statics. Instead, KCBS Pyongyang was caught on 2850.03 kHz under a flood of crashes and noises.

No fair conditions from Africa on 60 mt after sunset yet: listened usual stations in Nigeria, Chad, Burkina Faso, Djibouti etc., but with poor signals and QRN crashes. That's all for now. Till the next.

**Don Jensen <dnjkenosha@wi.rr.com>, Kenosha, WI**

Some weeks ago, I suggested the appointment of a QSL manager in the same way hams operate this sort of thing. A manager could receive and "bundle" reports and ship in one secure packet to R. St. Helena. A secure method? Several possibilities exist. Presumably, business institutions on the island receive securities and other valuables. It should be possible to find out the method used (commercial courier?) and duplicate that method. Or, the R. St. Helena staff may know a trustworthy islander who makes trips to and from the island. Perhaps the purser or captain of the RMS St. Helena, who could hand carry a package once a year. Presumably once reports and fees are received by the station, there is no problem with outgoing QSL cards. No thief would bother to steal them. It seems a doable process and could eliminate all the problems with individual reports being the target of thieves. Of course, the entire QSL process could be handled by the QSL manager, but I think listeners prefer to receive their card -- with its attractive postage -- directly from the station.

Radio Clube Paranaense: Report, f/up, returned as undeliverable this week. Bad timing. An on-line check revealed the fact that this one ceased independent operations in September when its entire journalist staff resigned. Must be a real story there, though I don't know what it is.

**Davis Yetman <Yetman@Earthlink.net>**

Not a Shortwave radio—but thought I would pass along my impression of Sangean PR-D5 AM/FM radio. It is billed as a successor to the RCA Superradio. Not ever having used one I can't comment on that point—but I can say that it is an impressive radio, worthy of consideration by anyone looking for a high quality AM/FM radio. AM reception is quite good owing to an internal 7" ferrite bar. I have been able to pick up all the significant New York City AM stations in Boston right from an indoor tabletop. Unfortunately there are no external antenna connections available. FM reception is also quite good. Tone is definitely good enough for FM radio—although there are no tone controls. It has a digital tuner/display, 5 presets available for AM and FM, HD Radio display, built in clock and alarm. It could use a few more presets but the digital display makes tuning pretty quick. There is also provision for AUX input which I guess could be used for an MP3 player. It's kind of heavy once the batteries are installed (6 'C' cells). It was \$95 at my electronics shop, which includes an AC adapter. I am definitely impressed with this radio—anyone looking for a high quality, digitally tuned, portable AM/FM radio with presets should give it look.

**Robert Swan <rdswan@atlanticbb.net>**

Re: Radio St. Helena: I had sent my report to P.O. Box 24. My letter was returned marked "insufficient address." I wonder if the post office at St. Helena did something with other letters with the wrong POB? Did anyone else send their reports to P.O. Box 24, instead of 93? I resent my report to P.O. Box 93 and received my QSL August 23, 2008.

**Mike Rohde <merohde@columbus.rr.com>, Columbus, OH**

We had our third Columbus NASWA meeting last Saturday (October 11). There were 7 attendees, 2 new and 5 regulars. I/ we did a presentation on Shortwave propagation. The presentation was more of a discussion and open for participation by all. It turned out

to be a great conversation with many attendees participating by both asking questions and imparting knowledge. I was very pleased with this as it appears that some of the regulars are starting to be comfortable enough to open up and contribute as well as ask questions. This is a very good sign. Both of the new attendees are NASWA members and saw the postings in the Journal so that has been very beneficial to us.

Fred Osterman was kind enough to provide copies of "Radio Propagation for Beginners" for everyone that attended. This is a pretty nice booklet that as the name implies covers most of the basics. It is also a great jumping off reference for more advanced discussions on the topic. We went a bit beyond this book by the time we were done but I think a more advanced discussion may be in order in the future when everyone is ready.

Fred and I have talked to George Zeller in the past about possibly doing a presentation on Pirate Radio in the future. I talked and e-mailed George last week and asked him to start thinking about a date. Fred thinks, and I agree would like a 2-3 month notice so we might promote the event. So, I hope George will start thinking about that and I will follow up in the future.

It was really interesting (remember me telling you I was having a hard time filling 2 hours) this meeting actually went a half hour over. That is a great sign! I am excited about how this meeting went and hope this what the future might be.

Per the a request of member next months program will be on antennas.

**Richard A. D'Angelo <rdangelo3@aol.com>, 2216 Burkey Drive, Wyomissing, PA 19610**  
I was saddened to learn of the passing of long time club member and former Flashsheet editor Ray Bauernhuber. Many club members knew Ray and everyone who was in contact with him enjoyed his perspective on life. He was a good friend to many and will be missed.

Only three QSLs to report this month. I miss begin to make it a point to get some reports out. I suppose it is difficult to get replies back if not too many reports go out in the first place. Nevertheless, here are my meager returns for this month. WYFR/Family Radio from Ascension Islands verified with a full data "1973 - Three Decades of faithful Service - 2003" card but for the first time in quite some time they did not indicate the transmission site. Of course, they did manage to include the usual assortment of stuff such as several stickers, religious pamphlets, a copy of Family Radio News, and the latest Language and Frequency Schedule. Adventist World Radio verified its Wertachtal relay with a full data "The Voice of Hope" card and personal letter from v/s Taylor Bajic in Listener Services (England) for a report to Media Broadcast. Syrian Arab Broadcasting Service verified with a full data logo card, sticker, program schedule and a copy of the March 10th English edition of the Syrian Times. Although it was a few months old, the Syrian Times provided the Syrian perspective on world events.

DXpedition planning is underway. It looks like our first adventure to French Creek State Park will be the Sunday through Tuesday just before Thanksgiving. This is a little later in November than usual but hopefully the little bit of extra darkness will be helpful while tuning the bands. With a little good fortune, I hope to be able to hear some stations that will peak my QSL writing interest.

I see our own Jerry Berg has two new titles about the history of shortwave radio out just in time for the holiday book giving season. Nice timing! I have already seen one and expect to have a review in Shortwave Center next month. However, I can tell you that the book is magnificent looking and is easy to read while fully covering our great hobby post-World War II.

# Book Profile

By Richard A. D'Angelo

*Listening on the Short Waves, 1945 to Today*  
(ISBN 978-0-7864-3996-6)

And

*Broadcasting on the Short Waves, 1945 to Today* (ISBN 978-0-7864-3674-3)

Both Written by Jerome S. Berg

Both Published by McFarland & Company

Just as *The Journal* was ready to be published, McFarland & Company released two new titles about the history of shortwave radio by our own Jerry Berg. Knowing interest would be keen in JB's new books, we thought providing a quick preview of these two titles would be of interest to members. A review copy arrived just as I was submitting this to Ralph Brandi/Bill Oliver so I expect to have a comprehensive review in next month's *Shortwave Center*.

*Listening on the Short Waves, 1945 to Today* (hardback, 415 pages, 120 photos, ISBN 978-0-7864-3996-6) is written from the standpoint of the serious shortwave enthusiast, *Listening on the Short Waves, 1945 to Today*, begins with an examination of the broad shortwave audience. It then presents in detail the histories of the major North American shortwave clubs, and reviews the professional and listener-generated shortwave literature of the era. It also covers the DX programs and other listening fare to which shortwave listeners were most attracted, and the QSL-cards they sought as confirmation of their reception. The book presents a chronology of the shortwave receivers available to listeners, and discusses how changes in receiver technology impacted the listening experience. It also addresses the important role that computers have played in the shortwave listening of recent decades.

Specific topics addressed:

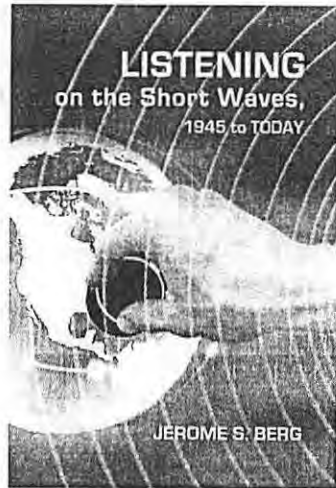

Chapter 1—Prelude to 1945: An introduction to the development of SWBCing through the war years.

Chapter 2—The Shortwave Audience: Who listens and why; SWLs vs. DXers; professional audience research; listener letters; early academic research on American SWLing, plus later studies; SWLs vs. hams; popularity polls; programming.

Chapter 3—Clubs: Detailed histories of the NNRC, ASWLC, NASWA, Canadian DX Club, CIDX, SPEEDX, ODXA, ADXR, ACE; also histories of the URDXC, ISWC, SWL International, Canadian SWL International, America Central Radio Club, International DXer's Club of San Diego, and others; ANARC and HAP; national, regional and local DX events; and foreign clubs in Australia, Denmark, New Zealand, Sri Lanka, Sweden, and the U.K. that have had an impact in the U.S.

Chapter 4—Shortwave Literature Since WW II: Official sources such as FBIS, BBCM and the Berne lists; electronics magazines (*Radio News*, *PE* and others), monitoring magazines (*DXing Horizons*, *S9*, *International Listener*, *Voices*, *MT*, *PopComm*, *International Radio*, etc.), and others; references like *White's*, *WRTH*, *Passport*, etc.; shortwave books and monographs, band

surveys, DX newsletters (including NU, FT, DXSF and many others), club publications, recordings, and DX humor.

**Chapter 5—DX Programs and Listener Clubs:** The history of the main DX programs, plus a review of other programs and station-run DX clubs.

**Chapter 6—Receivers:** A detailed historical review of the development of SW receivers since WW II--communications receivers, tabletops, portables, kits, etc., including receivers by Hallicrafters, Hammarlund, National, and other manufacturers past and present, with special attention to receivers that were intended for SWBC listening.

**Chapter 7—QSLing:** The verifiers and non-verifiers, station QSL policies, reporting techniques, QSL literature, DX statistics, awards and contests, country lists, SWL-card swapping, and WPE calls.

**Chapter 8—Computers:** Their impact, and that of the internet, on shortwave listening.

**Chapter 9—Conclusion:** Some ruminations on the future of SWBCing and SWLing.

*Broadcasting on the Short Waves, 1945 to Today* (hardback, 488 pages, 190 photos, ISBN 978-0-7864-36 74-3) focuses on the stations and the environment in which they operated. It contains a detailed account of the shortwave bands for each year from 1945 to the present. Written from the standpoint of the listener, it reviews what American listeners were hearing on both the international and domestic shortwave bands, describes the arrivals and departures of stations, and recounts important shortwave events. It also introduces readers to the several categories of broadcasters, explains the impact of relay stations, frequency management, and jamming, and describes technologies with the potential to benefit and burden shortwave listening. It also addresses the changes in, and challenges to, shortwave broadcasting since the end of the cold war.

The contents in detail:

**Chapter 1—Introduction to Shortwave Broadcasting:** An historical overview of international, domestic, religious, clandestine, European and North American pirate broadcasting, plus private U.S. broadcasting; frequency allocation and management, power, relay stations, jamming (including the ISWC anti-jamming campaign), SSB, and DRM; and SWBCing in the post-Soviet era, including leased-time and the commoditization of shortwave.

**Chapters 2-8—Shortwave Year-by-Year:** The heart of the book is a detailed, year-by-year examination of the stations that were active on the SWBC bands--stations that came on (or left) the air, stations that North American DXers were hearing, special on-air SW events, etc. These chapters cover 1945 to 2008 and identify both the individual DX targets and the macro trends of this 60+ year period. Both international stations, and tropical band and other domestic shortwave broadcasting stations throughout the world, are covered.

**Chapter 9—The Changing Shortwave Environment:** A summary of the shortwave broadcasting scene since WW II; factors that have impacted audiences and broadcasters (other media, deregulation, etc.) both before and after the cold war; and the future, including DRM and BPL.

Both books are 7x10" in size, and each includes a detailed index. For the benefit of those wishing to do additional reading or research, comprehensive endnotes and a selected bibliography contain extensive references to both popular and academic resources. The books are available from the publisher, McFarland & Co., Inc., Box 611, Jefferson, NC 28640, by mail, phone, FAX or on the web. See the McFarland website [www.mcfarlandpub.com](http://www.mcfarlandpub.com) for details. They are also available from Universal Radio in Reynoldsburg, Ohio, and from major Internet booksellers such as Amazon, Barnes & Noble, and Waterstone's. Each title lists for US\$59.95 plus shipping.



# On the Short Waves

On the Short Waves by Jerry Berg

<[www.ontheshortwaves.com](http://www.ontheshortwaves.com)> Update, September 27, 2008—Under “DX History/POW Monitoring” we have posted an article received from the New Zealand Radio DX League called “Amazing War Effort By A Small Group.” Authored by late Kiwi DXer Jack Fox, it details the history of the POW message monitoring effort in New Zealand during World War II. It also touches on POW monitoring during the Korean and Vietnam conflicts. Thanks to Jack (who, unfortunately, passed away in recent weeks) and the NZRDXL for bringing this to our attention.—On the same topic, we have also posted—under “Book Reviews” (and also under “DX History/POW Monitoring”)—a review of a new book titled World War II Radio Heroes: Letters of Compassion by Lisa L. Spahr. It is the story of the monitoring of a POW message from her grandfather, Robert May Spahr, who spent 26 months as a POW in World War II Germany. While examining the contents of an old trunk, the author discovered 69 cards and letters received by Robert Spahr, his mother—her great grandmother—after Robert, his name was mentioned in a German POW broadcast on May 8, 1943. The review focuses on two elements of the POW monitoring story: the Short-Wave Amateur Monitors Club, which was formed to organize POW monitors, and the American government’s reaction to POW monitoring. It also includes some new research on the subject.

<[www.ontheshortwaves.com](http://www.ontheshortwaves.com)> Update, October 9, 2008—Under “Specialized Resources,” Tom Williamson’s 99-page book, *Across Time—And Space: Listening for Sixty Years >From Four Continents*. Although radio often plays an important part in the lives of DXers, we seldom have the opportunity to learn their personal stories in depth. In this book, Tom tells how radio fit into his life, first during his years in England, and then (from 1966) in Canada. Tom, who is a physician, began listening in 1935. His extensive discussion of the stations he has heard over the decades is presented in a historical context, illustrated with many of the QSLs he has received. Tom does a great job describing what DXing was like over the many years that he has been active, and he also offers a few “sunset reflections.” Thanks to Tom, and Harold Sellers of ODXA, for their permission to post this interesting telling of one man’s radio story.

<[www.ontheshortwaves.com](http://www.ontheshortwaves.com)> Update, October 9, 2008—Under “New Books” on the < [www.ontheshortwaves.com](http://www.ontheshortwaves.com) > homepage, there is news about my two new books that pick up where the first one, *On the Short Waves, 1923-1945: Broadcast Listening in the Pioneer Days of Radio*, left off. The new ones are *Listening on the Short Waves, 1945 to Today*, and *Broadcasting on the Short Waves, 1945 to Today*. *Listening* covers the SW audience, clubs, SW literature, DX programs, QSLs, receivers, computers, etc. The heart of the *Broadcasting* book is a year-by-year look at the SWBCing bands, international and tropical, from 1945 to the present. The books are available from McFarland < [www.mcfarlandpub.com](http://www.mcfarlandpub.com) > and Universal < <http://www.universal-radio.com/> > as well as internet booksellers like Amazon and Barnes & Noble. They are big books—*Listening* is 415 pages, *Broadcasting* 488—with lots of memories. For more details, see the writeups at < [www.ontheshortwaves.com](http://www.ontheshortwaves.com) > (“New Books”) and at the McFarland website.

<[www.ontheshortwaves.com](http://www.ontheshortwaves.com)> Update, October 23, 2008—Under “Specialized Resources/Clandestine Corner,” the last six entries in this NASWA series from 1966-68: “Of Ships and Shoes and Sealing Wax,” “Indonesian Clandestine Off the Air,” “Radio Americas to Quit . . . Again,” “Peyk e Iran,” “The Voice of the Reich,” and “America Speaks to the Reich” (the last two were contributed to NASWA by Michael Silverstein).

# Easy Listening

Richard D. Cuff • 42 North 37th Street • Allentown, PA 18104 • richard@thecuffs.us

## Seasonal Changes—a musing

In some ways, the semi-annual rhythm of frequency and time changes that have long characterized *Easy Listening* targets on shortwave is less of a factor when one shifts listening to on-demand streaming or downloading. The semi-annual broadcaster watch becomes more important for program additions or deletions.

If you tend to listen to live audio streams via Wi-Fi “radios” or streaming via a computer, you do still have to pay attention to schedule changes. The BBC World Service, the Voice of Russia, and Radio Canada International come to mind as broadcasters that tend to switch in concert with Daylight Savings/Summer time: In the fall, the UTC times for these stations shift forward one hour, keeping air times the same in most European and North American time zones. In the case of the BBC, this usually means the Americas and Europe streams change, while the Africa stream tends to stay the same.

For those domestic spoken-word broadcasters that are generally of keenest interest to traditional shortwave listeners, these schedule changes are carried specifically and directly in concert with local time zone changes—since these stations target local audiences unconcerned with (and oblivious to) UTC.

I know of relatively few programming changes that will have occurred as of the B-08 changes; here's a brief list of what I know:

### BBC World Service—*The Strand*

The BBC launches a new, weekday arts program called *The Strand*. Here are some highlights

Presented by Harriett Gilbert and Mark Coles, the half-hour program takes listeners on a worldwide journey through arts, culture and entertainment. According to

the program producers, “Nothing creative is out of bounds”—and *The Strand* will bring the best, newest and most exciting creative enterprises to listeners around the world.

Novelist Harriett Gilbert has been presenting arts programs on the BBC World Service for over 10 years. She will present the Monday and Friday editions of *The Strand*, as well as a new hour-long version of another BBC World Service program, *World Book Club*, on the first weekend of every month.

Mark Coles, an award-winning broadcaster and acclaimed music journalist, will present the Tuesday, Wednesday, Thursday editions of *The Strand* as well as a special hour-long Saturday compilation. Mark—who has played Jimi Hendrix's guitar and was once locked in a cage with Yoko Ono—has interviewed some of the world's top writers. He says: “We'll provide our audience with a thoroughly entertaining, truly global guide to the arts. We'll be featuring some of the world's most famous and creative people and be offering unique insights into arts events and consumption of culture around the world.”

The program's scheduled guests for its first week (October 27<sup>th</sup>–31<sup>st</sup>) included Roger Moore (the longtime James Bond actor) and Candace Bushnell, the New York cultural observer who initially created the long-running *Sex and the City* HBO TV series.

I was interested to see if *The Strand* is merely the replacement for *Outlook*, another long-running program with significant artistic/human interest content, but this is not the case—*Outlook* remains on the World Service schedule.

*The Strand* will air in the shortwave schedule targeting West Africa weekdays at 1430 UTC, which stands a chance of propagat-

ing to North America given the frequencies typically in use then (17830, possibly 15400). *The Strand* will air in the live Infotainment webcast weekdays at 1030, 1530, 1930, and 2330, and also Tuesday-Saturday 0230 UTC. *The Strand* will not air in the live News webcast. Listeners who get their BBC fix via Sirius satellite radio and US public radio stations should tune in weekdays at 0930 if you are an especially early riser.

And, yes, *The Strand* will be available for on-demand listening; no word yet as to the podcast status.

## Radio Kuwait—worth an afternoon tune-in if you're around

One of the impressions that catalyzed my return to active shortwave listening in the 1980s was a visit to my brother in Florida. He was a work-at-home contractor, and one afternoon, while I was visiting, he walked over and switched his analog Radio Shack receiver to Radio Kuwait's English language service and kept it on for the afternoon.

My brother was an extremely casual listener—and still is—but found Radio Kuwait to be agreeable, unobtrusive, yet exotic accompaniment to his workday, with its mix of music, conversation, and features.

After a period of years off the air, Radio Kuwait is now pretty reliable on the air from 1800 to 2100 on 11990 kHz. Much of the time is popular music, which makes sense considering this is a relay of a domestic broadcast, but recent logs included by Glenn Hauser in *DX Listening Digest* updates indicate a feature program at 1800 beginning the broadcast, with news at 1830. These recent logs indicate the feature is typically about Kuwait culture and religion, focusing on the teachings of Islam; the program clearly targets a non-Islamic audience.

The reports posted to *DXLD* suggest propagation is sporadic, and less likely to be

successful the further inland you go. Not exactly *Easy* listening, but one is thankful for what is out there.

All the links I came across to any Radio Kuwait webcast were not working, so for now you're limited to shortwave.

## Cuts at ABC's Radio National affect Radio Australia

Most folks know that much of **Radio Australia** programming begins its life as features produced for the domestic spoken-word **Radio National** network; **Radio National** has been under threat of budget and programming cuts in recent years since the network has a comparatively small audience relative to the size of its budget.

That budget ax fell, and unfortunately several high-quality programs that were high on my target listening will be disappearing in 2009. These include *The Ark*, *In Conversation*, *Media Report*, *Perspective*, *Radio Eye*, *Religion Report*, *Sports Factor* and *Street Stories*. Of these, the one that I will miss the most is *The Ark*, but all of these were quality programs that were each a compelling listen. These programs are world-class, and can easily stand up to programming from much larger broadcasters (such as the BBC) with no apologies for content.

*The Ark* dealt with religious history, but in a way that seeks to explain the present by better understanding how events in a religion's history were documented and in what context they happened. These events could focus on individuals, but could also focus on places or dates. Definitely a thoughtful listen and certainly more interesting (to me anyway) than the latest facts and figures on Eastern Bloc industrial production.

Standard **Radio National** policy has been to make four weeks' worth of program archives available for online listening, and I hope this policy is liberalized for these programs.

Many have value far beyond the times of their original airing and could sound as fresh years later as they do today.

It appears that the resources that were utilized to produce these programs will be shifted somewhat to the domestic **NewsRadio** service; this is a 24-hour "rolling news" domestic network that has as its roots a relay of proceedings from the Australian Parliament. **NewsRadio** is a decent service, but it certainly is more repetitious and less specialized than **Radio National**.

The original plan had apparently been to end these programs as of mid-December, when many **Radio National** programs go on summer / Christmas / New Year's hiatus for a month, but the apparent leak of this story has led to the abrupt ending for some of them (including *The Ark*).

If you'd like to catch these programs on Radio Australia before they disappear, here are the currently-publish air times for them:

*The Ark*—Sundays 0405, 0705

*In Conversation*—Not currently on Radio Australia

*Media Report*—Thursdays 1031, 1530

*Perspective*—Not currently on Radio Australia

*Radio Eye*—Not currently on Radio Australia

*Religion Report*—Wednesdays 1031, 1530

*Sports Factor*—Fridays 1031, 1530

*Street Stories*—Not currently on Radio Australia

Links to all these programs are still active on the **Radio National** website, <http://www.abc.net.au/rn>.

## Bits & Pieces

*Australian Express* is transformed into *Australian Bite*

Another way that programming from **Radio National** made its way to **Radio Australia** is through the weekly magazine program *Australian Express*. Segments regarding aspects of Australian culture and perspectives would be edited with Roger Broadbent providing "continuity" commentary and background.

This program still exists, but it's now called *Australian Bite* and is now hosted by Heather Jarvis, a familiar name to Radio Australia listeners. The program presents "...a tasty spread of stories and music coming to you from all around Australia. From cafe culture to crested cockatoos, from arts and books to the mysteries of Australian rules football, there's something for everyone here in the pantry." (ABC website)

*Australian Bite* airs at the following times: Tuesdays, 1330, 1705, 1730; Fridays, 1830; Saturdays, 0030, 0505, 0530. The Tuesday 1330 airing will likely propagate best to Eastern North America in the winter.

*Australian Bite* is not directly offered as an on-demand program or podcast.

*Brain of Britain* in full swing (on BBC Radio 4)  
As the BBC World Service increased its emphasis in news and current affairs programming, one of the casualties was its comedy programming; the best-known of this genre was *Brain of Britain*, the general knowledge quiz that originated on the domestic BBC Radio 4 service. While you can't hear *Brain* on the World Service, you can still listen live and on-demand via Radio 4's web stream.

*Brain of Britain* has been around in one form or another since 1953; it has aired since 1967 under this title. The host, Robert Robinson, has held that position for more than 30 years.

**Brain** airs live Mondays at 1330 UTC, with a repeat Saturdays 2300 UTC, if your primary means of listening to Radio 4 is via its live webcast; the most recent edition is available on-demand as well.

**Brain of Britain** will crown its champion on January 24<sup>th</sup>, 2009.

You can Google “brain of Britain” as a phrase to quickly reach the website, or go directly to [www.bbc.co.uk/radio4/brainof-britain/](http://www.bbc.co.uk/radio4/brainof-britain/).

### **BBC World Service *Talking America* bus tour complete**

The BBC World Service “bus tour” of the USA, involving journalists representing many of the BBC’s domestic and foreign-language services, has recently wrapped up its west-to-east journey, and there are three 25-minute programs in which the presenters reflect on key highlights from each region they visited. From the main BBC World Service website, search for “talking America”—that’s the quickest way to reach the three-part audio programs.

### **More Music on Shortwave**

I was recently reminded of some additional sources for music on shortwave other than what I had mentioned before. These include Cuba’s **Radio Rebelde**, regularly on 5025 kHz, and Ethiopia’s **Radio Fana** on 6110

kHz. Not exactly rocking-chair reception, but you may find it enjoyable nonetheless. Thanks to Don Jensen for these suggestions!

### **CFRX is back on shortwave!**

After being missing for several years due to transmitter problems, Canada’s CFRX, the 6070 kHz shortwave relay of domestic MW station CFRB, is now back on the air, and some early hiccups appear to have settled out. On the air since 1937, CFRX provides an opportunity to “eavesdrop” on one of Canada’s largest cities, and can be a decent diversion, especially during the day. Its programming is a mix of news and talk, like that of many MW stations south of the border nowadays.

### **Would appreciate any suggestions on holiday / New Year’s programming**

I will dust off last year’s notes and suggestions on end-of-year programming for my December column, but if you have specific favorites you look forward to hearing each year from the international broadcasting community, send them my way and I will include them in my December column.

May your listening be enjoyable in November!

73 DE Richard

**SW**



# Shortwave Center

John Figliozzi • 45 Algonquin Rd • Clifton Park, NY 12065 • jfiglio1@nycap.rr.com

## World War II Radio Heroes: Letters of Compassion

by Lisa L. Spahr <http://www.spahrconsulting.com/> 2008, ISBN 978-0-9762181-7-3, 76 pages, softcover Available from internet booksellers and from Spahr Consulting, 7731 Abbott Street, Pittsburgh, PA 15221, [www.powletters.com](http://www.powletters.com) (\$15.95 plus postage)

Reviewed by Jerry Berg 38 Eastern Avenue  
Lexington, MA 02421 [jsberg@rcn.com](mailto:jsberg@rcn.com)

The story of POW message monitoring during World War II is a familiar one in the shortwave listening community. Many SWLs monitored the Axis shortwave stations in Germany, Japan, Singapore and elsewhere for such messages, which were usually voiced by announcers. The monitors would write down the POW's contact information and send the POW's loved ones a postcard or letter summarizing the message. These messages were often the first time that a family learned of the status of a husband, son or brother. For more on POW monitoring, see [www.ontheshortwaves.com](http://www.ontheshortwaves.com) ("DX History/POW Monitoring"), and *On the Short Waves, 1923-1945*, pp. 246-48.<sup>1</sup>

SWLs have usually viewed POW monitoring from the standpoint of the listener: times and frequencies monitored, and the techniques used for jotting down the information and contacting the family. (Most

<sup>1</sup> Jerome S. Berg, *On the Short Waves, 1923-1945—Broadcast Listening in the Pioneer Days of Radio* (Jefferson, NC: McFarland, 1999).

listeners hand wrote or typed individual postcards or letters. Some used specially designed forms.) Author Lisa L. Spahr, in her recent book, *World War II Radio Heroes: Letters of Compassion*, looks at POW monitoring from the viewpoint of the POW's family, for this is the story of the monitoring of an over-the-air message from her grandfather, Robert May Spahr, a 25-year old army infantryman who spent 26 months as a POW in Germany. While examining the contents of an old trunk full of his wartime items, she discovered 69 cards and letters received by Robert's mother—her great grandmother—in May 1943 after Robert's name was mentioned in a German POW broadcast on May 8 of that year. (Robert died in 1984.)



To students of shortwave history, the most interesting part of the book is the good-quality reproduction of 33 of the cards and letters, and the author's focus on various aspects of the correspondence. In addition, the author shares responses that she received from a few relatives of the monitors whom she was able to locate.

One postcard that caught my eye was from a listener whose name the author gave as "Paul Kany" of Johnstown, Pennsylvania. His handwritten signature could easily have been mistaken for that, but I recognized the name as Paul Kary, with whom I had had considerable correspondence 20 years ago when he donated his QSLs to the Committee

to Preserve Radio Verifications, of which I am the chair. Kary, whose full name was Paul A. Karagianis, will be remembered by DXers of the 1950s as a professional monitor at the U.S. government's Foreign Broadcast Information Service (FBIS) listening post on Cyprus. His DX news appeared in various magazines and club bulletins under the pseudonym "Middle East Correspondent." Kary moved from Portage, Pennsylvania to Johnstown in 1941 at age 15 and began his listening in 1942 with a Sears Silvertone receiver (which he soon replaced with a Hallicrafters Sky Buddy). He would have been 17 when he heard the POW message about Robert Spahr. Kary joined the military in 1944, and the FBIS in 1948. He graduated from the University of Pittsburgh in 1952 and worked for FBIS, usually in a non-monitoring capacity, during most of the years through 1974. However, he did three monitoring tours on Cyprus during the 1940s and 1950s. Eventually he retired to the U.K. His hobby focus was on SWBC listening until 1982, when he switched to utilities. He dropped his radio monitoring activities in 1988.

Two aspects of the POW monitoring story as told through the cards and letters in this book are worthy of special note. One is "SWAM," the Short-Wave Amateur Monitors Club, a group of listeners organized by Mrs. Ruby Yant of Lima, Ohio. She assigned each member a specific night of the week to monitor so that no messages would be missed. A copy of a SWAM newsletter (containing a membership list), and a SWAM postcard invitation to membership, both reproduced in the book, indicate that the group was formed in 1943 and had around 50 members in 1944. It was active until 1945.

The membership list is interesting. Of the 48 persons who were members on January 1, 1944, fully 21, or 44%, were women. Of six new members welcomed in March 1944, four were women. The percentage of women in SWAM is far greater than the female representation in either the ham radio or the shortwave listening communities, suggesting that POW monitoring was a homefront activity that extended well beyond organized hams and SWLs. Some of the moni-

tors had themselves been the recipients of messages about their imprisoned loved ones, or were listening in hopes of hearing such a message. Mrs. Yant's exact connection with radio is unclear. However, the SWAM materials are informal and non-technical, with a look and feel different from what might be expected of the radio cognoscenti.

Some of the SWAM monitors approached their job with a vengeance. Although surely not typical, at least two SWAM members had relayed 3,000 messages each. Another, Sanford Lowe of New York City, had sent over 5,000, and, according to a website referenced in the book (see note 3 below), eventually exceeded the 10,000 mark. (Both of these members were men.)<sup>2</sup> In one issue of the SWAM newsletter, members were alerted that a photo of one of their number, Alex E. Gordon, would appear in *Radio News* and *Popular Mechanics*. I dug up the February 1944 issue of the former, which shows Mr. Gordon (see below). Surely the club that is referenced was SWAM.

World War II Radio Heroes also reminds us of a usually-overlooked aspect of POW monitoring:<sup>3</sup> the suspicion with which it was viewed by the government. This is mentioned in a website—itsself very informative—which is referenced by the author; in a 1943 *American Legion Magazine* article which she cites; in the comments of a son of one of the monitors of the Robert Spahr message whom Lisa Spahr located; and in a *Monitoring Times* article on POW monitoring (see note 2 above). It is also confirmed by my separate research.

Some of the cards and letters depicted in the book seem to echo the issue. One begins, "By accident tuned my radio onto a German station and heard...." Another:

2 The work of one who had sent 3,000, Leroy F. Schum of Reading, Pennsylvania, was featured in *Monitoring Times* ("Homefront Hero of World War II," July 1995, p. 30). Schum's work, along with Lowe's and that of other monitors, is also discussed in Alice Brannigan, "SWLs: WW II's Homefront Heroes!" *Popular Communications*, February 1999, p. 10.

3 "Honoring Those Who Listened," <http://www.usmm.org/duffyhonoring.html>

"I tuned in last Sat. night on a foreign broadcast quite by chance..." Another: "While dialing among the shortwave stations on our radio late Saturday night, my father accidentally picked up a German broadcast from North Africa." And: "In case you should have missed a message to you by your son, which I by chance overheard on the radio..."

Shortwave listeners know that the casual or accidental reception of a station with sufficient clarity to permit one to write down the content of messages, and contact information, and without any advance preparation or premeditated focus on the task at hand (and with no recording equipment), while certainly not impossible, is a fairly unlikely scenario, even in the case of a powerful station like "Zeesen," as Berlin shortwave was known. Were these writers attempting to inoculate themselves against charges that, by listening to foreign broadcasts, they were facilitating enemy propagandizing and being disloyal? Most of the cards and letters did not indicate that the monitoring was accidental—in many cases it was clearly intentional and well planned—suggesting that citizen concern over the government's attitude toward their activities, whatever it was, was small. After all, information on enemy shortwave broadcasts was hardly secret. The times and frequencies of the news from Rome, Berlin and Tokyo were reported daily on the radio page of The New York Times.

As the author indicated, The American Legion Magazine article cited in the book<sup>4</sup> mainly provided details on the official sources of prisoner information. In its folksy

4 A. D. Rathbone IV, "Johnny Doughboy, Prisoner," The American Legion Magazine, October 1943, p. 13.

# Listening Post!



ALEX. E. GORDON, Indianapolis, Ind.—legislative representative of the Brotherhood of Locomotive Firemen and Engineers—brings good news to hundreds of mothers of missing servicemen, through his hobby and his faithful 16-tube, 1940 model

MIDWEST RADIO

ALWAYS a short-wave radio enthusiast, Alex. E. Gordon has spent many a night listening over his 16-tube Midwest Radio to foreign broadcasts. Several months ago he noticed that the Nazis, along with their propagandists, were mentioning the names of a few American prisoners each night. Mr. Gordon began to jot down the names and sent post-cards to the parents of the men named. The response to these cards was so instantaneous and gratifying that Mr. Gordon induced others to join with him in a Short Wave Listeners Club—each member of which is allotted a definite time at his listening post.

Mr. Gordon feels that he is amply repaid for his trouble by such grateful expressions of appreciation he has received: "It is a patriotic service for which I cannot thank you enough" . . . God bless you for your kindness" . . . and other similar statements received by this Midwest Radio owner.

Just another case where a Midwest Radio, famous for its ability to pull in long distance stations even under the most adverse conditions, is doing yeoman duty, until Victory will permit us to turn from our production of radio and electronic devices for your Armed Forces and resume the manufacture of finer radio receivers—at lowest Factory - To - You prices and at savings up to 50%.



**BUY MORE WAR BONDS**

SEND FOR  
**FREE INTERNATIONAL TIME CHART CALENDAR**

An attractive 4-color calendar with International Time Calculator will be sent FREE on your request if accompanied by 10c in stamps or coin for which we will send you a War Savings Stamp.



**MIDWEST RADIO CORPORATION**  
 DEPT. 11-G ESTABLISHED 1920 CINCINNATI, OHIO

style it also said:

There are several ways by which the folks might hear about it [a prisoner's status], but only two are reliable, and only one of them is official. If Pop tunes in on short-wave Radio Berlin, he might hear Johnny's name among those which Axis broadcasters announce as prisoners. That is neither reliable nor official. It is Nazi propaganda which is flavored with American names, sometimes fictitious, as bait to get us to listen. It might be true, but there's nothing anyone can do about it and the worst move that Pop can make under such circumstances is to write a letter to somebody, or spend money on a phone call or a telegram. He'd probably get the wrong party anyway, and even if he talked to Major General Allen Gullion, who is Provost Marshal General and

handles the whole prisoner of war problem, the General couldn't tell Pop whether the Nazis were lying or telling the truth. It's tough—mighty tough—but Mom and Pop will just have to sit tight and wait for the next development. This can take the form of either an official or an unofficial notice from the War Department, in Washington.

There is no doubt that the POW messages were "unofficial," and part of a propaganda effort, presumably intended to attract listeners and perhaps highlight supposedly humane POW treatment by the Axis countries. There is no specific evidence cited for the proposition that some of the names were fictitious. Clearly, however, the article seeks to discourage reliance on POW news contained in enemy broadcasts.

The extent to which reported FBI visits were part of a concrete effort to "monitor the monitors," or just isolated events, is unknown. What is clear from my review of wartime reporting in *The New York Times* is that the government did not like, and actively discouraged, citizen monitoring. It felt that the POW broadcasts were merely bait in the Axis propaganda war, and were intended to weaken the morale and the "will to fight" of relatives and friends of missing men.<sup>5</sup>

By 1943, unnamed government officials were reportedly "increasingly concerned" over citizen POW monitoring, which the *Times* said was "playing directly into the hands of the country's enemies." The monitors were, "in fact, primarily building up an audience for the propaganda broadcasts," and because there was no assurance of the information's accuracy, the monitors might be "precipitating needless disappointment and heartache."<sup>6</sup> The American Red Cross reported that hundreds of families had received "false casualty reports," and that enemy news of prisoners should be ignored. It quoted the FBI to the effect that "the spreading of such reports indicated a substantial force of enemy representatives strategically placed throughout the country, working under enemy orders to undermine

American morale." Although SWAM was not specifically associated with false reports, might the tenor of the government's reaction to citizen POW monitoring cause the man or woman on the street to actually mistake Ruby Yant and her SWAM cohorts for enemy agents?

In 1944, the *Times* pointed out a darker side of POW monitoring: "several self-appointed busybodies" calling relatives and asking for "fees ranging from \$3 to \$100 before repeating what they heard," or suggesting that "a few dollars would help to meet 'expenses.'" It suggested that the numerous "well-intentioned and patriotic" civilian monitors should leave the matter to the government.<sup>8</sup> A *Times* reader (and SWAM member) responded, and cautioned against making "the good suffer with the bad" and "smear[ing] those of us who are really rendering patriotic and altruistic service, absolutely gratis...." He noted that the hundreds of grateful replies from relatives, each one providing further comfort, proved the efficacy of the service, and he observed that the SWAM constitution prohibited soliciting funds for services rendered.<sup>9</sup>

The matter came up again in a book published in 1945. The authors of *Wartime Racketeers* included in their review of scams on POW families the relaying of shortwave broadcast POW information—sometimes "garbled, incomplete and inaccurate"—to relatives, by hams, for a "substantial fee," normally \$25.<sup>10</sup> This was accomplished days before the arrival of the information through official channels. Offenders were said to have lost their ham licenses and become liable to criminal prosecution. However, as the *Times* pointed out in a review of the book, in fact no ham had been found guilty of such charges. "The offenders," it pointed out, "were unscrupulous short-wave listeners and not representative of a patriotic group of hobbyists."<sup>11</sup>

7 *The New York Times*, September 20, 1943, p. 7.

8 *The New York Times*, March 12, 1944, p. X7.

9 *The New York Times*, March 26, 1944, p. X5.

10 Harry Lever & Joseph Young, *Wartime Racketeers* (New York, NY: G. T. Putnam's, 1945), pp. 31-32.

11 *The New York Times*, April 8, 1945, p. 100.

5 *The New York Times*, January 17, 1942, p. 3.

6 *The New York Times*, May 9, 1943, p. X7.

The military warned families not to accept enemy broadcast "news" as authentic, and not to be victimized by persons attempting to "sell" such information and to encourage them to listen to enemy broadcasts. They should "close their ears and pocketbooks" to the monitors, said an army official.<sup>12</sup>

Meanwhile, of the 33 cards and letters reproduced in World War II Radio Heroes, one writer asked, "Will you please donate a stamp or so to keep up the good work of message relays?" and another gave Robert's mother the name of a person who had donated postage as thanks for a message that she had received from the writer. There were no other references to payments or expenses.

It is important to note that there was indeed a government program designed to provide POW information free to relatives "in a matter of hours" by way of an initial telegram from the Foreign Broadcast Intelligence Service (an early name of the FBIS for which Paul Kary later worked). By one governmental account, a preliminary telegram to relatives contained the name of the captive and the country holding him, and a promise to check the accuracy of the information and advise further. This check (to confirm the soldier's serial number, whether he was in the combat area, and whether he was a POW) was said to take only 24 hours, and if the soldier's status as a POW was confirmed the full message was then sent to the relative in a second telegram.<sup>13</sup> By another account, the full message was always sent, and the telegram either confirmed his status as a POW or indicated that it could not be confirmed.<sup>14</sup> In April 1945, a month before the war ended

in Germany, four months before it ended in Japan, German and Japanese POW messages were being intercepted by the government at a rate of 115 a day.<sup>15</sup>

How well the government system worked is not known. Reproduced in Lisa Spahr's book is a telegram to Robert Spahr's mother from the Provost Marshal General advising her that they had just received a report from the International Red Cross that Robert was a POW in Germany. The telegram is dated May 7, 1943, and was received at 6:09 a.m. on May 8. The broadcast was heard by the various monitors on the evening of May 8, local time. Thus the telegram predated the broadcast.

*Justified over Radio WAR PRISONER INFORMATION from home*

**WAR PRISONER INFORMATION**  
A Free Humanitarian Service Given by  
"DAD MAC MANNIS' LISTENING POST"  
"A Veterans of Both Wars Keeping Faith With His Buddies"

*Safe & Well*

I have just received News from Radio Station DXJ, Berlin, Germany 8-7

that Your Son (Mac Mannis & No Name) Serial No. \_\_\_\_\_  
is a Prisoner of War in Germany. The report indicates that he is (well) (confirmed)  
and is being well taken care of don't worry he'll be home  
for Xmas - tell Frank he's the baby  
we'll see them soon - cause their invasion  
without scratch - Love to all  
your Son

**Please**  
May I have his picture and a reply to this report? Thank you.

"Dad" Mac Mannis  
315 Victoria Way  
West Palm Beach, Florida

This Florida monitor used a detailed card for reporting prisoner messages, and requested a photo. (National Archives and Records Administration, courtesy of Ann Elizabeth Pfau, author of "GIs, Gender and Domesticity During World War II" <<http://www.gutenberg-e.org/pfau/>>)

World War II Radio Heroes: Letters of Compassion is a valuable contribution to the body of information on this wartime short-wave activity, and I commend it to anyone interested in the subject. I also wish to thank Lisa Spahr for her help during the preparation of this review.

12 The New York Times, October 23, 1944, p. 5.

13 The New York Times, March 12, 1944, p. X7.

14 The New York Times, October 23, 1944, p. 5.

15 The New York Times, April 5, 1945, p. 5.

# Firedrake

## The source of China's Radio Jammer found on Chinasat 6B

By Mark Fahey

[Satdirectory – the free-to-air satellite directory [www.satdirectory.com](http://www.satdirectory.com)]

Some countries fear a free flow of information through the media and often go to extraordinary lengths to ensure they maintain control over the distribution of news and information in their nation. While some governments are kept busy building media firewalls or other barriers to stop outside information being received by their citizens, other groups are just as determined to allow their views to be heard behind these barriers.

Information can be diluted or restricted by many different methods. Some information is controlled via a relatively “light” non-technical approach, other “heavy” techniques use various technologies to jam or completely stop the flow of the information considered subversive.

An example of a “light” approach to control a media outlet may be the ridiculing of Al-Jazeera by senior members of the USA government. The anti Al-Jazeera campaign in the USA has led many in that nation to consider the broadcaster as an evil mouth-piece for Islamic terrorists and not ideal viewing by patriotic Americans. Meanwhile outside of the USA some view the station as un-biased and a shining example of a balanced media organisation.

A “heavier” approach may include national restrictions and censorship of the Internet or jamming of radio and television transmissions that do not align to a particular belief. Two groups that definitely don't see eye-to-eye when it comes to beliefs is the government of the Peoples Republic of China and the followers of Falun Gong. Both parties have been accused of being players in a constant war to control the delivery of information, and interestingly part of the war is being played out over satellites.

## Falun Gong—Satellite Hackers?

2007 is seeing a massive reorganisation of the domestic radio and television services delivered by satellite links in China. Over recent years the Chinese have been exposed to an embarrassing series of hijacks of these satellite links. The hijacks have seen the official evening news from Beijing being replaced by Falun Gong programming. For many years the AsiaSat, Sinosat and Apstar platforms have been used to distribute media across mainland China. As a result of the hijackings the services are now shifting on mass to two new satellites, Chinasat 6B and Sinosat 3. The new satellites have been built with systems that are designed to prevent the hacking of the services.

Chinasat 6B also plays another important role in the war of control of the Falun Gong, it is the source delivering the dreaded Firedrake Jammer to Chinese Radio Jamming transmitter sites.

## Firedrake Jammer

The Falun Gong's shortwave radio station The Sound of Hope is the main method of reaching their supporters in mainland China. Sound of Hope programs allege persecution and torture by the Peoples Republic of China, and as you might expect, the Chinese go to incredible efforts to ensure the station is basically impossible to listen to by jamming the station.

The Chinese Firedrake Jammer (also known as FireDragon) is a powerful transmitter that sits on top of the same frequency as the Sound of Hope. Firedrake covers the Falun Gong programming with loud Chinese Classical Music featuring gongs, flutes and drums. The Firedrake music is so intense that it usually completely dominates the frequency with the Falun Gong program underneath it becoming unintelligible.

Shortwave Radio Enthusiasts and Ham Radio operators have been watching China's Firedrake with interest. They believe that the primary Firedrake transmitter location is on Hainan Island off the coast of Southern China, however it is believed that there may be other transmitter sites also in use. It has also been noted that the Firedrake audio is a one hour loop with no announcements. This got us thinking at Satdirectory; how does the Firedrake programming get to the transmitter site? Is it delivered by a tape or CD on repeat, or is it like most other Chinese radio, delivered by a satellite link to the transmitter?

Well, a search with our 3 meter dish has found Firedrake! The audio is transmitted on Chinasat 6B within the China National Radio (CNR) satellite feed circuits. Many of the China National Radio feeds are in stereo, however one channel that is solely mono is CNR 8 - The Voice of the Minorities broadcast which features programs in the Kazakh, Korean, Mongolian, Tibetan and Uighur languages. The CNR 8 audio feed to the Chinese transmitter sites can be found on the left audio channel of a feed circuit labeled "Lzh8Rdjy". On the right audio channel of this feed is the audio for the Firedrake transmitters.

Following our discovery we tuned up a shortwave receiver to 17780 kHz which at the time also had the jammer running. The audio from the satellite feed and the shortwave radio were synchronised with no delay. This confirmed that the Firedrake shortwave transmitter site was also being fed by the same satellite feed, otherwise we would have expected a delay of a second or so due to the satellite uplink and downlink path delay when compared to the shortwave broadcast.

Satdirectory can confirm that the Firedrake audio program is exactly 60 minutes (down to the second actually) and we have made a full studio quality copy of the broadcast which can be made available on CD for study and academic use on request.

China National Radio and the Firedrake audio feeds are available via Chinasat 6B.

Firedrake - Right Audio Lzh8Rdjy Circuit  
Satellite : Chinasat 6B  
Orbit Location : 115.5 East  
Frequency : 4175  
Polarity : Vertical  
Symbol Rate : 5990  
FEC: 1/2

## **It Had To Be EWE**

### **This Antenna Really Works Well!**

By Bryan Clark

On the recommendation of ace DXer Paul Ormandy, and with practical assistance from Ray Crawford and Sutton Burtenshaw, I finally commissioned 2 EWE antennas in November 2007. Paul had made up the required parts for me some time before, but as something of a technophobe, it needed a couple of technically competent radio amateurs armed with soldering irons to get me going! Last month I commissioned a third EWE by myself and now feel able to confidently recommend this antenna to others.

I think it's called a EWE because the antenna configuration is an inverted U shape. The

first person to describe the EWE was an American radio amateur Floyd Koontz (WA2WVL) in 1995. The antenna wire itself runs down each mast, and is earthed at each end. The quietness of reception on a EWE is possibly the most impressive thing about them, but most importantly, you must have a preamplifier to deliver a worthwhile signal, along with a weatherproofed balun (matching transformer) at one end, and a weatherproofed variable resistance (potentiometer) at the other.

I am very fortunate to have plenty of space for antennas, and a location relatively free from man-made interference, but I understand that the EWE will work well in noisier

urban locations too, helping reduce TVI and other interferences. However it is important to keep the antenna as remote as is possible from metal buildings, gutters etc.

EWE antennas can be constructed to varying lengths and heights, such as 3 metres high and 7.5 metres long, but I am very pleased with the dimensions Paul recommended—5 metres high, 15 metres long—to suit both medium wave and shortwave DXing. The dimensions chosen for the antenna, the preferred listening range, and the ground conductivity at your location will dictate the resistance value (I've seen recommendations ranging between 800 Ohms and 1000 Ohms, so a variable pot is the best approach).

Indeed the most difficult aspect of constructing my EWEs was tuning the pot to the optimal setting for medium wave DX. I'm told I should tune it for a null or most reduced signal from a station 'off the back-end'. But here in Northland there isn't really a candidate to my west or northwest. I'm waiting for really fine weather when I can carry the radio out to the pot location and then try and tweak the pot whilst listening to a few different stations within a hundred kilometres of my location.

My hope with the EWE was that it would give me improved DX on medium wave. They have certainly done this, but with the added bonus of outperforming all my other antennas—100 metre BOG (beverage on ground) longwires and a 20 metre long Alpha Delta Sloper SWL antenna (purchased from Universal Radio USA)—on shortwave as well! In particular, the tropical band frequencies—between 2 and 6 MHz are much better received on a EWE.

Here's my component list:

Here's my component list:

- 2 antenna masts 5 metres high (I was lucky to have some lengths of Oregon timber). You can use longer e.g. 7m poles

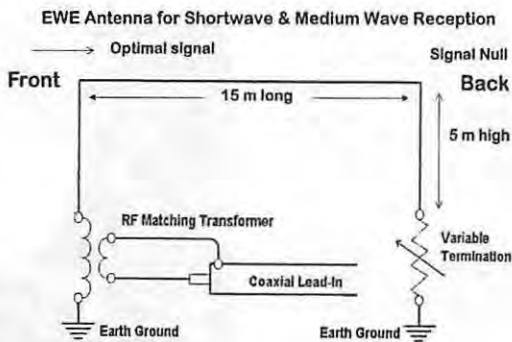

Figure 1. Diagram of EWE Antenna

and bury two metres if you wish to avoid guy wires, or drive steel stakes into the ground and lash 5m poles to the stakes)

- Guy wires and insulators to support these masts.
- Insulator at top of each antenna mast (as my poles are wooden, I use electric fence Screw-In Ring Insulators made by Gallagher—I have plenty, let me know if you want a pair).
- 25 metres of insulated Antenna Wire (5 metres up, 15 metres across, 5 metres down) 1.0–2.5mm electrical appliance wire is fine.
- 2 Earth Ground Rods (mine are Earth Peg ECDR12-1800 Utilux Earth Stake Copper Clad purchased from J. A. Russell Ltd last October for \$15 each plus GST).
- 2 Earth Clamps (for Earth Rod attachment), from J. A. Russell Ltd, about \$5 each.
- Matching Transformer (Balun) in waterproof container, constructed for me by Paul Ormandy. Paul can be contacted at [zl4pw@orcon.net.nz](mailto:zl4pw@orcon.net.nz) or snail mail — 33 Greta Street, Oamaru.
- Variable Resistance (Potentiometer) in waterproof container, also constructed by Paul Ormandy (contact details above).

- Length of Coaxial Cable (50 or 75 ohms) for lead-in wire to run from Balun at front of antenna (remember that lead-in runs from the 'front end' of the antenna).
- Broadband Pre-Amplifier. Mine came recommended by quite a few EWE 'farmers' and is made by Advanced Receiver Research, Box 1242, Burlington CT 06013, USA. Their model AR<sup>2</sup> P0.5-30 /20VD has a bandwidth of 500 kHz to 30 MHz, that is medium wave and short-wave. Cost is US\$55.00. Check out the "Broadband LF Preamplifiers" page at [www.advancedreceiver.com/](http://www.advancedreceiver.com/)
- 12 volts DC power supply for the pre-amplifier.

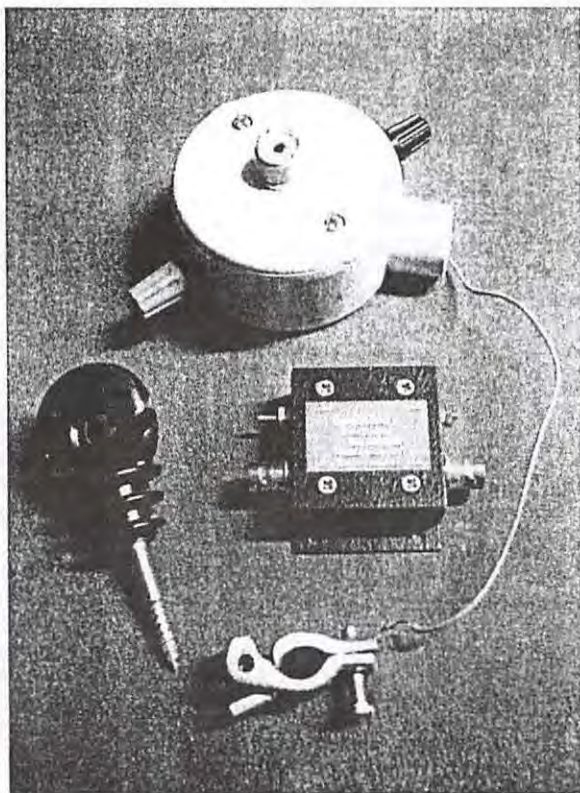

Figure 2. Some EWE components—weatherproof balun (matching transformer) by Paul Ormandy; AR<sup>2</sup> broadband preamplifier, Screw-In Ring Insulator, Earth Clamp.

This all adds up to a bit of cost overall, but I think the results of the EWE antenna are worth a whole lot more, especially because of its superior performance on both shortwave and medium wave. I only have to look at the quality logs in my logbook over the past 9 months for the proof, for example the 2007 Radio St Helena broadcast, Radio Peace from Sudan 4750 kHz, Radio Djibouti 4780 kHz opening transmission at 0300 UTC and 90 metre band Africans at 0445 UTC. On the broadcast band, a lot of new Alaskans and previously unheard Canadian and US stations have been added to the logbook, all thanks to my 'flock' of EWEs.

[This article originally appeared in the DX Times published by the New Zealand Radio DX League under the stewardship of Mark Nicholls]

Bryan Clark

# Loudenboomer Report: AokiDoKi

By Charlie Loudenboomer

Hi there friends, Charlie L. comin' back at ya!

Still looking for a new rx to replace the old Hammascratcher, which hasn't been the same since I set the frying pan on a 6BZ6 trying to scramble an egg one morning. As for the FROgy 7, I think it may have croaked its last. But that's a subject for another day.

I did print out copies of the Aoki and EiBi lists the other evening after hearing so much about them in the past few months. In fact, I hear so much about what Aoki "has" on a certain frequency at some particular time, or what EiBi lists on 11,995 at 2015, that it almost sounded like black magic.

And Percyus, that newfangled "flat-screen-picture-of-a-receiver," has these databases built in. Automatically, Percyus knows where you're tuned, and when, and tells you what you're listening to. OK, what you PRESUMABLY are listening to! Sounds great, but just remember to put that little (p) in when you post your report, just to keep your reputation sweet and clean!

We all know that Aoki and EiBi are compiled on somebody's high powered computer from OFFICIAL "freq 'n' sked" info that OFFICIAL station OFFICIALS file twice a year with an OFFICIALLY important international organizations that exists to collect such OFFICIAL information. Geez-mighty, that's Official to the fifth powerA! It's gotta be right! As a pedigree, that trumps even the old FBIS books we relied on in the olden days. We knew that FBIS was really, nudge, nudge, wink, wink, the CIA!

I am a bit bothered, though, that Aoki/EiBi seem to have assumed such credibility! People lie awake nights, barely able to wait

for the issuance of the B-08! "Mercy, how can I succeed without the latest EiBi, or the hot-off-the-printer Aoki!! Can I make them twice as good by merging them!!"

Dare CL suggest that some are putting too much faith in these databases? I have even overheard comments like: "Aoki lists Vladivostok here at that hour. I don't see anything else in Russian." Or even, "Must be RFA, according to EiBi. What else could it be!" We had a name for that sort of thing in the old days—list logging.

But ol' CL doesn't want to seem, well, a fuddy-duddy, so I'd better get with the times. Using EiBi and Aoki, I tried to listen the newfangled way. I heard a lotta CHINA RADIO INTER., FAMILY RADIO, VOICE OF RUSSIA, CHINA RADIO INTER., RADIO EXTERIOR DE ESPANA, more CHINA RADIO INTER., RADIO PRAGUE, even more CHINA RADIO INTER. Bor-r-r-r-ing!

I soon concluded if I really wanted to DX, I had to create my own computer list. I built my database without any of those ordinary "upper case" stations that fill EiBi and Aoki. I decided to call mine AokiDoKi and it only has good stuff on it!

There are Bhutan, AIR Andaman Is., Hargeisa, Tristan duh Cunning! Also it has its share of golden oldies, too, Radio Clube Cuanza Sul, Andorradio, Falkland Islands Bcg. Service, even Radio Hong Kong.

Soon I'm going to put the AokiDoKi on the internet so everybody can download and use it. I am sure it will soon drive Aoki and EiBi out of business. After all, if one is going to "list log," why not use a better list? 

# Listener's Notebook

Al Quaglieri • P.O. Box 888 • Albany, NY 12201-0888 • listenersnotebook@gmail.com

**ABKHAZIA** *Apsua Radio* heard in Russian at 9494.8 at 1400 with identification "Apsua Radio" and "Radio Abchasiya Respublika", news headlines followed by folk music. (Patrick Robic, Austria, A-DX via Wolfgang Bueschel) Heard in Russian on 9494.8 1530-1600 September 6 in Russian with strong signal, heard earlier at 0400-0515 on 9495.6, two different transmitters in use? On September 8 they were on 9494.8 morning and afternoon. On September 9 they were on 9495.6, this transmitter has a modulator problem and a wobbling audio signal. Sign off was 0806. (Wolfgang Bueschel) September 15 and 16 in Northern Bulgaria I observed short-wave broadcasts on 9495 at 0400-0600 and 0700-0800 with own programs in Abkhaz, relay Radio Rossii 0600-0700. At 1100-1130 there were programs with news in Abkha & Russian. At 1354 sign-on on 9495, 1400-1500 Abkhaz Radio, 1500-1559 pop music program of Vesti FM, closed at 1600. (Rumen Pankov via Wolfgang Bueschel)

E-mail reply from Apsua Radio which, translated from Russian, reads, in part: "Good evening, Don Jensen. We have received your letter. Thank you for the fact that responded to our radio broadcasting. We are very pleased to hear from you that information. Yes, indeed, you listened Abkhaz radio. We get lots of (mail) from different countries as Canada, Italy, Greece, Holland and other countries. Our editorial staff will write more to you on the radio program Abkhazia Apsua Radio." Since receiving this I have had several more email interchanges with the sender with information that they hope to have an English service, but, unfortunately, not any time soon. The report was sent via registered mail to the several mail drops in Russia which I found in on-line searches. I don't know which one of them actually got through to the station in Sukhumi. Email reply came from apsuaradio1@mail.ru. Dan Henderson has also now had a reply from that address in 4 days. All my emails translated into Russian using Google translate which I also used to translate the replies. (Don Jensen, Wisconsin, NASWA Yahoo Group/via WWDXC Contact/Cumbre DX)

## **ALBANIA** tentative B08 winter schedule of *Radio Tirana*:

0000-0130	Albanian	6110 SHI 9345 SHI
0130-0145	English	9345 SHI Tu-Sa
0245-0300	English	7390 SHI Tu-Su
0330-0400	English	6110 SHI Tu-Su
0430-0500	English	6100 SHI Tu-Su
0730-0900	Albanian	7360 SHI
0901-1000	Albanian	7360 SHI

1530-1600	English	13720 SHI Mo-Sa
1800-1830	Italian	7465 SHI Mo-Sa
1830-1900	French	7465 SHI Mo-Sa
1900-1915	Serbian	6010 SHI Mo-Sa
1945-2000	English	7465 SHI 11645 SHI Mo-Sa
2001-2030	French	7465 SHI Mo-Sa
2001-2030	Italian	6155 SHI Mo-Sa
2031-2100	German	7465 SHI
2100-2130	English	7510 SHI 9345 SHI
2130-2300	Albanian	9345 SHI 7510 SHI

(DX Mix—Bulgaria + Hauser-OK)

## **ALGERIA [NON]** Tentatively a new series of *Radio Algerienne* specials towards Sahara and Sahel zone via Issoudun site like in last Jan/Feb:

0400-0500	5905 7305
0500-0600	5905 6170 7305
0600-0700	7115 9535
0700-0800	11615 13570
0800-0900	13570 13650 15230 15360
1700-1800	13570 15165
1800-1900	11880 12025 13570
1900-2000	9390 11880 12025
2000-2100	7210 9390
2100-2200	7210 7420 7455
2200-2300	5910 7295 7420 7455
2300-2400	5910 7295

(Gordon Brown-UK, NWDXC Sept 29/WWDXC)

## *Radio Algeria* Holy Qur'an Service in Arabic:

0400-0500	5905 ISS
0500-0600	5905 ISS alt. 6170/7115
0700-0800	11615 ISS 13570 ISS
0800-0900	13570 ISS alt.13650/15360 15230
0900-1000	15230 ISS
1700-1800	15165 ISS alt.13570
1800-1900	13570 ISS 11880 ISS alt.12025
1900-2000	9390 ISS 11880 ISS alt.12025
2000-2100	7210 ISS 9390 ISS
2100-2200	7210 ISS
2200-2400	5910 ISS alt. 7295

## Registered frequencies for B-08:

0400-0500	7295 ISS
0500-0600	5960 ISS alt. 6170/7295
0600-0700	9390 ISS
0600-0700	9430 ISS
0700-0800	11625 ISS alt.13570
0700-0800	9435 ISS alt.11625
0800-1000	15230 ISS alt.15320
0800-1100	15615 ISS
1600-1700	15165 ISS
1700-1800	13570 ISS
1700-2000	9390 ISS

1800-2100 9825 ISS alt. 9835  
 2000-2200 7175 ISS alt. 7375  
 2100-2300 7295 ISS

(DX Mix-Bulgaria)

**ARGENTINA RAE** now is active again on 15345 kHz again, frequency checked by my DX friend, Norberto Pugliese at 2254 UT. (Gabriel Ivan Barrera-ARG, DXplorer Oct 8/WWDXC)

**Radio Baluarte**, Puerto Iguaz, 0930-1342, Sep 20, 22 and 27, Spanish (W) and Portuguese (M) religious talks and hymns, ann phone number, // FM frequency, Portuguese ID: "Foz do Iguau." (Grimm-BRZ, Slaen-ARG and Wilkner-FL/DSWCI DX-Window/Petersen-DK)

**AUSTRIA ORS** Frequency Schedule B-08:

5955	1800-2000	<b>VoVTN</b>
5970	0200-0300	<b>AWR Urdu/Pan</b>
6015	0500-0530	<b>BBC Eurasia Mo-Fr</b>
6045	0430-0500	<b>AWR French</b>
6050	1600-1650	<b>BBC Eurasia Mo-Fr</b>
6050	1600-1630	<b>BBC Eurasia Sa/Su</b>
6095	0330-0430	<b>AWR Persian</b>
6155	0600-1800	<b>OE 1 Intern</b>
6155	2100-2200	<b>OE 1 Intern</b>
7215	1729-1758	<b>TWR Persian</b>
7325	0000-0030	<b>OE 1 Intern</b>
7325	0030-0100	<b>OE 1 Intern</b>
9495	1500-1600	<b>TWR Bel/Ru</b>
9535	1900-1930	<b>AWR Hausa</b>
9535	1930-2000	<b>AWR French</b>
9605	1830-1900	<b>AWR Arabic</b>
9685	1630-1700	<b>TWR Armenian</b>
9770	2000-2030	<b>AWR Dyu</b>
9805	2030-2100	<b>AWR French</b>
9805	2100-2200	<b>RCT French</b>
9825	1800-1830	<b>AWR MisZndDinAch</b>
9830	1630-1728	<b>AWR Persian</b>
9830	2100-2130	<b>AWR En</b>
9840	0100-0130	<b>OE 1 Intern</b>
11910	1600-1630	<b>AWR Urdu</b>
13730	0600-1400	<b>OE 1 Intern</b>
13740	0625-0659	<b>BBC AF Hausa</b>
15160	1500-1530	<b>AWR Turkish</b>
15220	0800-0830	<b>FEBAR Arab</b>
15440	1400-1430	<b>AWR Urdu</b>
17610	1430-1500	<b>AWR Aar</b>
17855	1300-1330	<b>OE 1 Intern</b>
17870	0600-0630	<b>OE 1 Intern</b>

(ORS, via ADDX Andreas Volk-D/Bueschel/DX Listening Digest/Hauser-OK)

**BOLIVIA 6075 Radio Kausachun Coca.** Nice CP folk mx at 1004 t/in. Another song started at 1010. Then canned promo anmnts at 1012 by 2 men w/ID, FM freq 9? (possibly 90.5), MW could only copy "amplitud modulada" and SW as "6,075 onda corta banda internacional de 49 metros," possibly xmsn times, another clear ID, then program shouted. Fair-

ly strong w/moderate fading and some co-channel QRM. Glad to get this one. (Valko-PA, 3 October/Cumbre DX)

**6075 Radio Causachun Coca**, Lauca, Chapare, has a 10 kW transmitter of the Continental Lensa brand. Prifilo Condori Choque, general manager of the company that installed the transmitter, says that the antenna system consists of two loop antennas with reflectors. Each antenna is supported by two 15-meter towers, and the reflector is located six meters from the radiator. The location of the antenna is at 16 59'48,00" S 65 13'40,25" W. The antennas are at 265 meters above sea level. (Klemetz in DXplorer, Oct 07/DSWCI DX-Window/Petersen-DK)

**BULGARIA** Winter B-08 of **Radio Bulgaria**:

0000-0100	English	5900 7400
0000-0100	Russian	6200
0000-0100	Spanish	7200 7300
0100-0200	Bulgarian	5900 7200 7300 7400
0200-0300	French	5900 7400
0200-0300	Spanish	7200 7300
0300-0400	English	5900 7400
0400-0500	Russian	5900 7400
0500-0600	Bulgarian	5900 6000 7400 Sa/Su
0530-0600	Bulgarian	5900 6000 7400 Mo-Fr
0600-0630	Greek	6000 Mo-Fr
0600-0630	Russian	5900 7400
0600-0630	Turkish	6100 7300
0600-0700	Greek	6000 Sa/Su
0630-0700	Albanian	6000 Mo-Fr
0630-0700	German	5900 7400
0700-0730	French	5900 7400
0700-0730	Serbian	6000 Mo-Fr
0700-0730	Spanish	7200 7300
0700-0800	Albanian	6000 Sa/Su
0730-0800	English	5900 7400
0800-0900	Serbian	6000 Sa/Su
1100-1130	Bulgarian	6000 11600 11700 13600 15700
1100-1130	Turkish	6100 7300
1130-1200	German	11700 15700
1130-1200	Greek	6000
1130-1200	Russian	11600 13600
1200-1230	Albanian	6000
1200-1230	French	11700 15700
1200-1230	Spanish	13600 15600
1230-1300	English	11700 15700
1230-1300	Serbian	6000
1300-1500	Bulgarian	11700 15700
1500-1600	Russian	7200 7400
1600-1700	Bulgarian	7200 7400 15700
1700-1730	Russian	7200 7400
1730-1800	German	6200 7400
1730-1800	Spanish	5900 7200
1800-1830	French	6200 7400
1830-1900	English	6200 7400
1830-1900	Turkish	6000
1900-2000	Russian	6200 7400
1900-2100	Bulgarian	5900 6000

2000-2100	German	6200 7400
2100-2200	French	6200 7400
2200-0400	Bulgarian	6000 Su-Mo Radio Varna
2200-2300	English	6200 7400
2230-2330	Spanish	5900 7200

(DX Mix—Bulgaria)

**CHINA** 5075 *Shanghai PBS/Voice of Pujiang*, 1320-1351, Oct 5 and 6, has changed back to their winter frequency (ex: 9705), fair, last heard here around April, noted the usual // 4950 (fair) and 3280 (weak) (Ron Howard-CA/Cumbre DX)

**CHINA—TAIWAN** Winter B-08 schedule of *Radio Taiwan International* via TDF France:

0200-0258	Spanish	9800 GUF
1400-1458	Russian	15430 ISS
1600-1658	English	9785 ISS
1700-1758	English	11850 ISS
1700-1758	Russian	6120 ISS
1800-1858	English	3965 ISS
1900-1958	French	9365 ISS
2000-2058	Spanish	3965 ISS
2100-2158	German	3965 ISS

(DX Mix—Bulgaria)

**CLANDESTINE** 15650 *Voice of Oromo Independence*, via Juelich, Germany \*1730-1830\*, since Sep 19, heard on Fr Oct 03, new transmission on Fridays in Amharic via Media Broadcast, opens with Horn of Africa folksong, talk with a few musical interludes. (Ivanov, via BC-DX and Gupta Sep 30/DSW-Cl DX-Window/Petersen-DK)

**COSTA RICA** *Radio Exterior de Espana (REE)* in Spanish from Cariari de Pococ:

0000-0200	6020
0200-0400	3350 6020 9630
0400-0600	3350 5965 9630
0600-0800	5965
1000-1100	5930 Mo-Fr
1100-1300	5930 5970 15170 Mo-Fr
1200-1500	9765 11815 15170 Su
1300-1400	5970 15170 Mo-Fr
1500-2300	9765 11815 17850 Su
1600-2300	9765 11815 17850 Sa
1800-2000	9765 11815 17850 Mo-Fr

(Marcelo A. Cornachioni, Argentina/Conexion Digital)

**CROATIA** Winter B-08 schedule of *Croatian Radio HS-1* in Croatian:

0558-0857	Croatian	6165 DEA
0858-1457	Croatian	9830 DEA
1458-2157	Croatian	6165 DEA
2158-0557	Croatian	3985vDEA

(DX Mix—Bulgaria)

Could be a 10 kW transmitter, using an antenna that cannot handle higher powers. (Kai Ludwig-D, DX Listening Digest Oct 9) 3984.84 odd [re Kai's comment] Croatian Radio in 75 mb is not very strong these days, compared to powerful 100 kW signal on both 6165 and 9830 kHz channels daytime. S=8 at 2215 UT Oct 10th.

Whether the fountain like 75 mb antenna is not very effective to cover central Europe too, or they produce only a strong signal 'CLOSE TO' the tx site on the balkans. I guess the old 10 kW unit of the early 90ties is in use in 75 mb during nighttime 2130-0600 UT, in B-08 2130-0700 UT, because of the inaccuracy of approx. 160 Hertz less.

On Oct 9th at 2230 UT the transmitter at Deanovec was switched ON and OFF never-ending, and signal was so POOR, like missing final stage booster that night. (Bueschel-DE, Oct 10/Hard Core DX)

**ECUADOR** New DRM transmissions of *HCJB Global*:

0830-0930	Spanish	11625 OUI Mo-Fr
0900-1030	German	11625 OUI Sa/Su
0930-1030	German	11625 OUI Mo-Fr
1500-1700	Portuguese	11705 OUI

(DX Mix—Bulgaria)

**HCJB** for B08 in regional languages:

0000-0030	Cofan	6050
0000-0300	Quechua	3220 6080
0800-0830	Quechua	21455U
0830-0900	Quechua	3220 6080 21455U
0900-1030	Quechua	3220 6080 6125 21455U
1030-1100	Quechua	3220 6080 21455U
1030-1100	Wadani	6050
1100-1130	Cofan	6050
1100-1300	Quechua	3220 6080
2100-2300	Quechua	6080 9745
2245-2300	Kulina	11920
2300-2400	Quechua	6080
2330-2400	Wadani	6050

(Marcelo A. Cornachioni, Argentina/Conexion Digital)

**EGYPT** *Radio Cairo* tentative B-08 English:

0200-0330	7535
1215-1330	17835
1600-1800	12170
1900-2030	9310
2115-2245	6255
2300-2430	6850

Other languages [partial]:

0030-0430	Arabic	6850
0045-0200	Spanish	7535 9360 9915
1900-0700	Arabic	6290
2215-2330	Portuguese	9360

(Glenn Hauser, Oct 18/DX Listening Digest)

GERMANY Deutsche Welle B08 schedule:				
0000-0100	English	7265-Tr 9785-Tr 15595-P	1330-1400 Dari	9380-Y 12090-Tr
0000-0200	German	6075-Si 7120-Si 7285-Tr	1400-1430 Pashto	12090-Tr
		9545-A 9655-Ki 11690-Ki	1400-1457 German	15640-Si
0100-0130	Bengali	9850-Ch 11820-Kj	1400-1500 Amharic	11645-Ki 15620-Tr
0100-0200	Russian	5925-R 15640-Tr 17700-Tr	1400-1500 German	6075-W 9545-Sk(Sa)
				13780-Tr 15275-Ki
0130-0200	Hindi	9850-Ch 9880-Ki 11820-Kj	1430-1458 Urdu	12090-Tr
			1500-1530 Hindi	9650-Tr 11995-Tr
			1500-1600 German	6075-W 9545-Sk(Sa)
0200-0230	Urdu	9850-Tr 17800-Kj		13780-Tr 15275-Ki
0200-0400	German	6075-R 6075-Si		15640-R
0200-0400	Russian	5905-R 15640-Tr	1500-1600 Russian	9715-D 11720-R 15620-Si
0300-0400	English	9800-Tr 13810-D	1500-1600 Swahili	7300-Ki 9800-Ki 11645-Ki 17800-D
0300-0400	Swahili	6180-Ki 9565-Si 15600-Tr		
0330-0400	Persian	5965-Kn 9820-Ki	1530-1600 Bengali	9650-Tr 11995-Tr
0400-0430	Arabic	6035-Sk 7415-R 9820-Ki	1600-1700 English	5965-Tr 9560-Tr
0400-0500	English	5905-W 5945-Si 6180-Ki 15600-Tr	1600-1700 French	9535-Ki 11795-Ki 12035-R 15275-R 17800-Si
0400-0500	German	6075-Si 9735-W 13780-Kn 17800-Tr	1600-1700 German	6075-W 9545-R 12055-Tr 12070-Ki 13780-W
0400-0500	Russian	12025-Ki 15640-Tr	1600-1700 Russian	7145-D 9715-R 12080-Si
0430-0500	Arabic	6035-R 6135-Sk 9755-Ki	1700-1730 Urdu	9495-Si 11695-Tr
0500-0530	Belorussian	15205-D 23456	1700-1800 French	9535-Ki 9735-W 12035-W 13790-Si 15275-Ki
0500-0530	English	6180-Ki 7285-R 9755-Ki 12045-Ki 15600-D	1700-1800 German	6075-Si 6075-W 9545-R 12055-Tr 12070-Ki 13780-W
0500-0600	German	6075-Si 6075-Sk 9735-W 13780-Kn 17800-Tr	1700-1800 Russian	7145-W 9715-Tr
0500-0600	Russian	5915-R 15640-Ki 17700-Tr	1800-1858 Arabic	13780-Tr
			1800-1900 Hausa	9430-Si 11690-Ki 15275-Ki
0530-0600	Portuguese	12045-Ki 15600-D		
0600-0630	English	5945-W 7240-Si 12045-Ki	1800-2000 Arabic	7280-W 11605-Tr 11925-Ki 11925-W 13790-Ki
0600-0630	Russian	5915-R 15640-Ki		
0600-0800	German	6075-Si 6075-W 9545-W 12005-Ki 15410-Ki	1800-2000 German	6075-Si 6075-W 9545-R 11725-Ki 12070-W 15440-Si
0630-0700	Hausa	5945-Si 7240-W 12045-Ki		
0800-0830	Pashto	11820-D 15640-Tr	1800-2000 Russian	5980-D 7145-W 9715-Tr
0800-1000	German	6075-W 9545-W 9885-B 13780-W 17520-Tr	1830-1900 Persian	5910-Kn 5925-N
			1900-1930 English	9735-Ki 11690-M 13780-Tr 15275-Si
0830-0900	Dari	11820-D 15640-Tr		
0900-1000	English	17710-Tr 21840-Tr	1930-2000 Portuguese	9735-Ki 13780-Tr 15275-Si
1000-1100	German	5905-B 6075-W 9545-Sk(Sa) 9865-Cy 13780-W 15610-Tr	2000-2100 English	9545-W 9735-Ki 13780-Tr 15275-D
1000-1100	Swahili	9800-Ki 12045-Ki 15410-Ki 21780-Si	2000-2100 German	6075-D 9510-Tr 11605-Ki 6180-R 7145-Si
1030-1150	Chinese	12010-Kj 13680-Tr 15640-Tr	2000-2100 Russian	5905-Si 6130-Sk 9495-Tr 13790-Ki
1100-1200	German	5905-B 6075-W 9545-Sk(Sa) 13780-W 15610-Tr 17770-A	2100-2200 English	7280-Si 9545-Tr 11690-Ki 13780-Tr
			2100-2200 German	6075-D 11935-Ki
1200-1300	French	15410-Ki 15440-R 17520-W 17800-Ki 21780-D	2200-2300 German	6075-D 9545-D 11690-Ki 11865-Si
1200-1300	Indonesian	9655-Tr 15640-Tr	2200-2300 Indonesian	6000-Tr 7380-Ta 9720-Ki
1200-1400	German	6075-W 9545-Sk(Sa) 13780-Si 15610-Tr 17630-R	2300-2350 Chinese	9865-Kj 11830-P
			2300-2400 German	6050-Tr 6075-Si 9545-D 11690-Ki 11865-Si
1300-1330	Chinese	6130-N 9650-Kj 11945-Tr 13735-Tr		
1300-1400	Hausa	15440-Ki 17800-Ki 21780-Si	Sites:	
			A=Ascension	
			B=Bonaire	

Ch=Chita  
 Cy=Cypress Creek  
 D=Dhabayya  
 Ki=Kigali  
 Kj=Kranji  
 Kn=Krasnodar  
 M=Meyerton  
 N=Novosibirsk  
 P=Petropavlovsk  
 R=Rampisham  
 Si=Sines  
 Sk=Skelton  
 Ta=Talata Vo.  
 Tr=Trincomale  
 W=Woofferton  
 Y=Yerevan  
 (DX Mix-Bulgaria)

New transmission for *Voice of Oromiya Independence* via Media Broadcast:

1730-1800 Amharic 15650 JUL  
 (DX Mix—Bulgaria)

**GREENLAND** 3815.0 23.9 2015 Tasillaq, Gronland (*Ammasalik Radio*) relaying Nuuk. Best in USB. (Thomas Nilsson-SWE/SWB/Johnson/Cumbre DX) Ritola-FINLAND added this was best heard on 3814.96 USB. [Thought this one was long gone. - ed]

**GUATEMALA** 4052.5. On Oct 04, I received this message from the Director of *Radio Verdad*:

"To all Friends of "Radio Truth:"

I send you my best wishes. Many may ask: What happened to "Radio Truth?" I am sorry, but, because excess of work, it is now that I send you the official information. On Monday, September 22, at 4:00pm (Guatemala time), a disastrous lightning hit our SW transmitter antenna, despite having 3 lightning rods, with 3 tips each, the electric transformer lightning rod, and a well calibrated spark device inside of the transmitter, with a good grounding using #2 copper wire. As a consequence, we burned out almost all power transistors and some smaller ones on our two output modules. So we are off the air, and we don't know for how long. I thought I had enough spare power transistors, but they were not enough. Our transistors are very strange, and difficult to find in all the world. They work on 600 volts. So we'll have to ask them to be produced in the United States. We appreciate our friends Magdiel Cruz, from Mexico, Dino Bloise, from Miami, and other friends, who have spread this information. We expect the help of Christer Brunstrm, from Sweden, and HCJB also. We are grateful for the sympathy expressed by many "Dxers." Now we have to ask God to help us get back on the air. In the mean time, I invite you to tune our signal over Internet via the following address: [www.radioverdad.org](http://www.radioverdad.org).

Edgar Amlcar Madrid, Manager and Director. "  
 (Azevedo-BRZ/DSWCI DX-Window/Petersen-DK)

**HUNGARY** Winter B-08 schedule of *Hungarian Radio* in Hungarian:

0200-0300	Hungarian	5995 JBR
0500-0600	Hungarian	3975 JBR
1100-1200	Hungarian	6025 JBR
1700-1800	Hungarian	6025 JBR
2200-2300	Hungarian	3975 JBR

(DX Mix—Bulgaria)

B-08 schedule of *Hungarian Radio* in Hungarian via Media Broadcast [Germany]

0100-0200	5980 WER
0200-0300	6145 WER
0500-0830	6145 WER
1100-1200	3975 WER
1200-1300	17690 WER
1500-1800	3975 WER
1900-2000	3975 WER 9845 WER
2100-2200	3975 WER 5970 WER
2300-2400	6025 WER 9665 WER

(DX Mix—Bulgaria)

**INDONESIA** 3578.74 unID 1313-1350+ Oct 6. Talk, mostly by W to 1334, then ten minutes of what sounded like island mx. Weak and getting weaker, with more snippets of mx after 1345. (Wilkins-CO/Cumbre DX)

3344.96 *RRI Ternate* 1330-1401 Oct 10. Vocal, mx, W anc in Bahasa Indonesia, I think, indicating Ternate rather than R. Northern. Poor at tune-in; very poor at ToH. (Wilkins-CO/Cumbre DX)

4749.96 *RRI Makassar* 1307-1400+ Oct 12. Pop mx; W & M (mostly W) with long yaks between mx segments; frequent mentions of Makassar; pgm continued past ToH. Good at tune-in; still fair at 1400. (Wilkins-CO/Cumbre DX)

**IRAN IRIB** English schedule B08:

0130-0230	6120 7160
1030-1130	15460 17660
1530-1630	7330 6160
1930-2030	6010 7260 7320 9855 11695

(Jaisakthivel, India, Oct 22/DX Listening Digest/Hauser-OK)

**ITALY [NON]** Winter B-08 of *NEXUS-IBA IRRS Shortwave* from Milan, via Slovakia:

0530-0630	English	5990 RSO Mo-Th <i>European Gospel Radio</i>
1030-1300	English	9510 RSO Su <i>European Gospel Radio</i>
1400-1430	English	15725 RSO Su <i>European Gospel Radio</i>
1500-1800	En/Ara	15650 RSO <i>Miraya FM Radio, Sudan</i>
1900-2100	English	7290 RSO Fr-Su <i>European Gospel Radio</i>

(DX Mix—Bulgaria)

**KYRGYZSTAN** 6030 Thanks to Mauno Ritola's tip I tried Kyrgyzstan, *Radio Maranatha* on 7 Oct. Noted the buzzy/humming carrier under Chinese station around 1455. There was also a ute-rtty below the frequency and a nasty whining spur from some faulty bc transmitter nearby on 6033. Around 1530 the spur disappeared and I could hear the presumed Maranatha with talks and music similar to Mauno's audio clip. Too weak modulation to get any ID this time. The language sounds like Pashto or similar of that region. Around 1551 Oromiya switched on with interval-signal and that was it for today. (Savolainen-Finland/Cumbre DX)

**MEXICO** 6104.68, *Candela FM*, Merida, (pres)1000-1010 Noted a strong carrier on this freq prior to the hour. On the hour, the broadcast begins with music for a minute or two, then comments by a male. As it turns out, the signal is very distorted and almost impossible to copy. I was able to pick out some details such as the place name, "Mexico" during comments and promos. Strong carrier but distorted audio. I think Candela dropped off the air by 1010 possibly because of this distortion mentioned above because I couldn't hear anything but the carrier by then. However, checking back at 1020, the only signal I could hear on this freq was the Brazilian, which was much weaker. (Chuck Bolland, FL, October 17/Cumbre DX)...seems on all day with distorted signal into various parts of Florida (Wilkner-FL, 20 Oct/Cumbre DX)

**MOLDOVA** Frequency change of *Radio PMR* Mon-Fri from Sep.7:

1400-1415	English	NF 7370 KCH, ex 12135
1415-1430	French	NF 7370 KCH, ex 12135
1430-1445	German	NF 7370 KCH, ex 12135
1445-1500	English	NF 7370 KCH, ex 12135
1500-1515	French	NF 7370 KCH, ex 12135
1515-1530	German	NF 7370 KCH, ex 12135
1530-1545	English	NF 7370 KCH, ex 12135
1545-1600	French	NF 7370 KCH, ex 12135
1600-1615	German	NF 7370 KCH, ex 12135
1615-1630	English	NF 7370 KCH, ex 12135
1630-1645	French	NF 7370 KCH, ex 12135
1645-1700	German	NF 7370 KCH, ex 12135

(DX Mix—Bulgaria)

**MYANMAR** 5770, *Myanmar Defense Forces BS* via Taunggyi, 1418-1431\*, Oct 14, new sign-off time (earlier this month had observed their usual 1530 sign-off, within a minute or two), in vernacular, pop songs, brief selection of indigenous instrumental music at sign-off. (Woward-CA/Cumbre DX)

9730.77, *Myanma R.*, 1440-1458, Oct 5, in vernacular and English, continues to provide a lot of educational programming, spelling words in English, lesson in business English ("The goods under consideration are inferior goods. If more buyers enter a market the cost. the demand will rise," etc.), mostly poor (Howard-CA/Cumbre DX)

**NEW ZEALAND** *Radio New Zealand International* B-08 schedule:

0459-0658	11725am & 15720 DRM
0659-1058	9765am & 9870 DRM
1059-1258	13840am & 9870 DRM
1258-1358	13840am
1300-1550	6170am
1551-1650	6170am & 7145 DRM
1650-1750	9765am & 9890 DRM
1750-1950	11725am & 11675 DRM
1951-2235	16775am & 15720 DRM
2236-0458	15720am & 16765 DRM

(Glenn Hauser, OK/DX Listening Digest)

**PORTUGAL** *RDPI Radio Portugal* for B08:

0000-0300	9455 9855 11655 Tu-Sa
0600-0700	12130 Mo-Fr
0700-0745	9815 Mo-Fr
0745-0900	9815 11660S Mo-Fr
0800-0930	12020 15520 Sa/Su
0900-1100	9815 Mo-Fr
0930-1100	9815S 12020 15520 Sa/Su
1100-1200	12020 15520 21655Sa/Su
1100-1300	9815 15690 Mo-Fr
1200-1300	11885 15520 21655 Sa/Su
1300-1500	11885 15520 15560 21655 Sa/Su
1300-1700	15560 # Mo-Fr
1400-1600	15690 Mo-Fr
1500-1700	11635 15520 15560 21655 Sa/Su
1700-1900	13720 15465 Sa/Su
1700-1900	17825 Sa/Su
1700-1900	17825 # Mo-Fr
1700-2000	9455 13720 15465 Mo-Fr
1900-2000	12040 # Mo-Fr
1900-2100	12040 13720 15465 Sa/Su
2000-2300	9795 11960 #
2000-2400	11825 12040 # Mo-Fr
2100-2400	12040 # Sa/Su
2300-2400	7145 11960 #

S=via Sines

#=special broadcasts only: they may use the full period or just parts thereof, usually announced during the previous day's broadcast.

(Goncalves, Portugal/DX Listening Digest/Hauser-OK)

**PRIDNESTROVYE** *Radio PMR Pridnestrovye* observed on 7370 while band scanning on September 9 at 1400, ex 12135. Rolling program of English, French and German. English to Europe at 1400, 1445, 1530 and 1615. French 1415, 1500, 1545, 1630. German 1430, 1515, 1600, 1645. Monday to Friday. No change to North American service, still noted on 6040 September 15. (Edwin Southwell) Heard here in English 1400 to 1415 September 23 on 7370, the entire program was on the Republic of South Ossetia celebrating the eighteenth anniversary of its declaration of state sovereignty and recognition of this by Russia. Excellent reception. (Mike Barraclough/WWDXC Contact/Cumbre DX)

**ROMANIA** Winter B-08 schedule of *Radio Romania International*:

0000-0056	Spanish	5960 9525 9665 11960
0100-0156	English	6145 9515
0100-0156	Romanian	5910 9640
0200-0256	French	5975 9515
0200-0256	Romanian	5910 9640
0300-0356	Spanish	6140 9635 9765 11825
0400-0456	English	6115 9515 9690 11895
0500-0526	Chinese	15160 17870
0500-0556	Romanian	6055 7220 new transmission
0530-0556	Russian	6175 7210
0600-0626	French	7170 9610
0630-0656	English	7180 9690 15135 17780
0700-0726	German	7175 9690
0730-0756	Arabic	11710 11905 15155 15330
0800-0856	Romanian	11730 15370 15430 17775 Su "Curierul romanesc"
0900-0956	Romanian	15380 15430 17745 17775 Su "Curierul romanesc"
1000-1056	Romanian	15260 15380 17780 17825 Su "Curierul romanesc"
1100-1156	French	15150 15255 17790 17845
1200-1256	German	9690 11940
1300-1356	English	15105 17745
1300-1356	Romanian	9610 11940 15170
1400-1426	Chinese	9660 12005
1400-1456	Romanian	9610 11940 15170
1430-1456	Russian	9535 11905
1500-1526	Italian	7160
1500-1556	Arabic	9655 11730 11880 15235
1530-1556	Aromanian	6105
1600-1626	Ukrainian	6130
1600-1656	Romanian	9700 11870
1600-1656	Russian	6025 7190
1630-1656	Serbian	6025
1700-1726	Italian	9855
1700-1730	German	5875 DRM via KVI
1700-1756	French	7135 9690
1700-1756	Romanian	7335 9595
1730-1756	Aromanian	6015
1800-1826	Ukrainian	7160
1800-1830	English	5875 or 5895 DRM via KVI
1800-1856	English	7215 9640
1800-1856	Romanian	7140 9590
1830-1856	Serbian	7130
1900-1926	Italian	6180
1900-1956	German	7125 9525
1900-1956	Romanian	7140 9590
1930-1956	Aromanian	6110
2000-2026	Ukrainian	5960
2000-2056	Romanian	7125 9565 new transmission
2000-2056	Spanish	7140 9620

2030-2056	Serbian	5970
2100-2126	French	6030 7120
2130-2156	English	6030 6115 7145 9755
2200-2256	Spanish	6070 9575
2300-2356	English	6015 6115 7105 9610

(DX Mix—Bulgaria)

**SLOVAKIA** *Radio Slovakia International* for winter 2008/2009:

0100-0130	English	7230 9440
0130-0200	Slovak	7200 9440
0200-0230	French	7200 9440
0230-0300	Spanish	7230 9440
0700-0730	English	13715 15460
0730-0800	Slovak	13715 15460
0800-0830	German	5915 6055
1400-1430	Russian	9540 13710
1430-1500	German	6055 7345
1530-1600	Spanish	9445 11600
1600-1630	Russian	5915 6055
1630-1700	Slovak	5915 6055
1700-1730	German	5915 6055
1730-1800	English	5915 6055
1800-1830	French	5915 6055
1830-1900	Russian	5915 9485
1900-1930	German	5915 7345
1930-2000	English	5915 7345
2000-2030	Slovak	5915 7345
2030-2100	French	5915 7345
2100-2130	Spanish	9460 11610

(via Jose Miguel Romero, Spain, Oct 22/DX Listening Digest/Hauser-OK)

**SUDAN** *Radio Peace* was briefly back on the air, but is now off again. They are working to get back on 4750 and 5895. (Johnson Oct 8/Cumbre DX)

**SUDAN [NON] SITE** 11635 *Affia Darfur* Thanks Kim Andrew Elliott tip, new IBB program for Darfur. News read by man and woman in Arabic, ID at 1810. Then more by the same. Fair reception. (Johnson Oct 9/Cumbre DX)

**SWEDEN** *Radio Sweden* B08:

0000-0030	Swedish	9490-C
0030-0100	Swedish	6100-C
0200-0230	Swedish	6010-C 11550-M
0230-0300	English	6010-C 11550-M
0300-0330	Swedish	6010-C
0330-0400	English	6010-C
0500-0600	Swedish-P1	9490 Mo-Fr
0600-0800	Swedish-P1	6065 Mo-Fr
1200-1215	Swedish	7420 Mo-Fr
1200-1230	Swedish	7420 Sa/Su
1215-1230	Swedish	11550 Mo-Fr
1300-1315	Swedish	11675 Mo-Fr
1315-1330	Swedish	7465 11675 Mo-Fr
1330-1400	English	7465
1400-1430	Swedish	9400 9490 11540
1400-1430	Russian	9530
1430-1500	English	9400
1500-1530	Russian	5850

1500-1530	Swedish	9360 Sa	0500-0600	Ukrainian	5830
1500-1530	Swedish	9365 Su	0600-0700	English	7440
1500-1530	Swedish	9360 Mo-Fr	0700-0900	Ukrainian	7440
1530-1600	English	9360	0900-1000	Ukrainian	9950
1600-1630	Farsi	9360 We-Fr	1000-1100	English	9950
1600-1630	Assyr/Aram	9360 Th/Fr	1100-1200	Ukrainian	9950
1630-1700	Kurdish	9360 Mo-Fr	1200-1300	English	9950
1645-1700	Swedish-P1	5865 Su	1300-1400	Ukrainian	9950
1645-1715	Swedish-P1	5865 Mo-Sa	1400-1800	Ukrainian	5830
1700-1730	Swedish	7475 7465	1800-1900	German	7510
1730-1800	Arabic	7465 Mo-Fr	1900-2000	Ukrainian	7510
1730-1800	Russian	6065	2000-2100	English	7510
1800-1830	Swedish	5865	2100-2200	German	5830
1830-1900	Belarusian	6065 Sa-Tu	2200-2300	English	5830
1900-1930	Swedish	5865 7465	2300-2400	Ukrainian	5830
1930-2000	Russian	6065			
2000-2030	Swedish	5850 9895-M			
2030-2100	Russian	5850			
2030-2100	English	9895-M			
2100-2130	Swedish	7395-M			
2100-2130	Belarusian	5840 Sa-Tu			
2100-2200	Swedish-P1	5850			
2130-2200	Romani	5840 Sa/Su			
2130-2200	English	7395-M			
2200-2230	Swedish	5850			
2200-2300	Romani	5840 Sa/Su			
2230-2300	English	5850			

(DX Mix—Bulgaria)

**UNITED STATES** Email from Larry Thom (Chief Engineer *WRNO*) at 1700 UTC, Oct 21:

We are currently off the air but should be back on soon. Elcor (transmitter manufacturer) is making modifications to the oscillator sections to give it more stability. Additionally, we are awaiting delivery of a Vacuum Variable Capacitor for final RF power output section of the transmitter. The transmitter was furnished with Jennings Glass type vacuum variables. We changed out all but two for the ceramic type before going on the air as they are more durable to high voltage arching, etc. which are encountered by all high power shortwave stations from time to time. Just the nature of the beast! As luck would have it the one that wasn't replaced caused us a problem on 7.505 Mhz. At this point we are just working out the bugs that come along with the installation of a new transmitter, but having said that, we hope this will take care of most of the issues at hand and cause us less down time in the future.

Thanks,

Larry

(Ron Howard, CA/Cumbre DX)

**VOA Restructures Bosnian, Hindi, Serbian, Macedonian, Russian Broadcasts**

Washington, D.C., September 29, 2008

The Voice of America (VOA) is ceasing radio broadcasts in Hindi, Bosnian, Serbian, and Macedonian on September 30, 2008, using available resources to reach audiences in those markets through television and the Internet. No VOA language service will be shut down and no jobs will be lost. VOA also is discontinuing its 30-minute Russian weekly television program and will deliver text, audio, and video content to Russia's fast-growing Internet market. VOA will be accessible through digital devices, including mobile Internet devices, cell phones that receive text and multi-media messages, and MP3 players.

All Swedish is Radio Sweden except: P1—Swedish Radio 1st channel

C=via Sackville, Canada

M=via Madagascar

(via Lekic-Serbia/Aleksandr Diadishev, Ukraine/Roberto Scaglione/DX Listening Digest/Hauser-OK)

**TAJIKISTAN** Thanks to the tip from S. Hasegawa in Japan via DXLD, I can hear *Tajik Radio* every night here (between 1200 and 1500z;) on 4635. Their signals are consistently 33233 here, with presumed spy-numbers CW QRM at times, buzz in their audio which sounds like their transmitter, and some local line noise. Tajik sounds exactly like Farsi to my ears; they are closely related languages from what I understand. The music they play is fascinating, and worth a little line-noise degradation in order to listen to them (Steven Zimmerman, South Korea, Oct 8, DX Listening Digest)

**TANZANIA [NON] Lutheran Radio Centre** Pulling up some details on this one via their website, thanks WRTH for the address—Seems like sked is 0300-0400 6110 1700-1800 9475 All in Swahili via TWR Swaziland. Local SW is still listed as planned. (Johnson Oct 6/Cumbre DX)

**UKRAINE** Winter B-07 for *Radio Ukraine International*:

0000-0100	German	5830 7440
0100-0200	English	5830 7440
0300-0400	Ukrainian	5830 7440
0400-0500	English	5830 7440

VOA's Russian radio broadcasts ended in July 2008. The change in VOA Russian's program delivery reflects the crackdown on independent media and freedom of speech in Russia. Russian government pressure has forced almost all VOA local radio and television affiliates to drop VOA and other international broadcasts. Shortwave radio listenership also has continued to decline throughout the country, with fewer than 2% of Russians using this medium weekly. "We owe great thanks to the VOA radio journalists who have broadcast to these countries over the years," said VOA Director Danforth Austin.

Radio Free Europe/Radio Liberty (RFE/RL) will continue radio broadcasting to Russia, Bosnia, Macedonia, and Serbia. VOA and RFE/RL are part of the Broadcasting Board of Governors (BBG), the independent government agency that oversees all U.S. international broadcasting. (VOA Press Release/WWDXC)

From 1st October VOA Bangla service is moving on to 9320 kHz (to get good propagation) replacing 11835 kHz from Philippine relay at 1600-1700 hrs to South Asia and parallel 7260 kHz from Thailand relay continues. (Alok Dasgupta, India/WWDXC)

Cancelled transmissions of **WYFR Family Radio** via VT Comm.:

0400-0500	German	3955 SKN
1230-1330	Bengali	15340 DHA
1600-1700	Portuguese	17545 ASC
1800-1900	English	3955 SKN 11775 SKN 13780 RMP
1800-2000	English	11775 SKN
1900-2000	French	11970 DHA

1900-2000	Arabic	15165 SKN
2000-2100	English	3230 MEY 9485 DHA 11970 DHA
2030-2130	French	11985 KIG
2115-2315	English	11875 ASC

(DX Mix—Bulgaria)

Frequency change for *Voice of America* in Bangla:

1600-1700	Bangla	NF 9320 PHT, ex 11835 // 7260 UDO
-----------	--------	-----------------------------------

(DX Mix—Bulgaria)

**VANUATU VTBC** Port Vila is currently using a low power modified amateur radio transmitter to broadcast weak signals on 7260 kHz. Reception has been monitored of Pacific style music in the past day or so. The new 10kW shortwave transmitters are still enroute to Vanuatu. Delivery has been delayed for a variety of reasons, including difficulties obtaining freight space on cargo ships visiting Vila. An RNZI technician has just returned from Vila where preparation work has been underway for installation of the two new DRM/analog transmitters later this year.

The frequency of 7260 is one of several registered for VTBC for the new service and the current broadcasts appear to be a prelude to the full service starting as soon as the new transmitters are installed. (David Ricquish, Radio Heritage Foundation, [www.radioheritage.net/WWDXC](http://www.radioheritage.net/WWDXC)) 

**WORLD OF RADIO SHORTWAVE AIRINGS B-08, with projected time shifts effective Nov 2, 2008. All times and days strictly UT**

- Wed 2200 WBCQ 15420-CUSB
- Thu 0630 WRMI 9955
- Thu 1530 WRMI 9955
- Fri 0030 WBCQ 7415
- Fri 0200 WRMI 9955
- Fri 0900 WRMI 9955
- Fri 2030 IPAR/IRRS/NEXUS/IBA 7290 via Slovakia
- Fri 2130 WWCR1 15825
- Sat 0000 WBCQ 5110-CUSB Area 51
- Sat 0900 WRMI 9955
- Sat 1730 WWCR3 12160
- Sun 0330 WWCR3 5070
- Sun 0730 WWCR1 3215
- Sun 0900 WRMI 9955
- Sun 1615 WRMI 9955
- Mon 2300 WBCQ 7415 [temporary?]
- Tue 1200 WRMI 9955
- Tue 1630 WRMI 9955
- Wed 0630 WRMI 9955
- Wed 1230 WRMI 9955

# Pirate Radio Report

Chris Lobdell • P.O. Box 146 • Stoneham, MA 02180-0146 • clobdell@verizon.net

Hello and welcome to the November 2008 edition of the *Pirate Radio Report*! We are now entering the prime DX season for pirates and Euro pirates as well. Send us your logs!

## The Great Halloween Pirate Massacre of 1998

It's hard to believe it's been 10 years since the last major shortwave pirate bust. Here is what I wrote in my *December 1998* column:

"What some are calling '*The Great Halloween Pirate Massacre of 1998*' occurred on October 30th and 31st when the friendly FCC agents tracked down and visited four alleged pirate operators in MA, IL, TX and CA. The stations were handed violation notices, told to stop operations immediately and warned that fines or equipment seizures would be forthcoming if broadcasts continued."

When will the next shortwave pirate busts occur? For our first reader who can correctly name the 4 stations busted, a *free copy* of either the complete Radio Azteca, KIPM or K2000 collection on audio CD. Your choice.

**Balls To The Walls Radio**, heard on 6925 USB at 2308-2330 sign off on October 13th. First log of this station. Good show featuring music by ZZ Top, Golden Earring, Foghat, and others. Several IDs Some fading and static. Also QRM from Spanish speaking stations with yells and whistles. Lost signal at 2330 after OM gave test count. [Wood-TN]

**Betty Boo Radio**. This Halloween themed pirate was logged on October 19th at 1232 UTC on 6925 AM mode. Signed on with organ music. Music from the 1930s and a cameo ID by the OP of Indira Calling. Announced the now closed Providence, RI maildrop. [Lobdell-MA]

**Mad Dog Radio**, heard on 6925 USB from 1554-1559 sign off on October 19th. SIO=141+. Two rock tunes and then a single ID by OM at the quick close. My first reception of this one. No address noted [Zeller-OH]

**Radio Free Speech**, noted on 6792.5, 2220 UTC on Oct 13th. Great signal here! Good. [Also] 2031, Oct 12th, English, Bill O Rights had Commander Bunny as a guest on the show. CB said that if elected he would make Bill O Rights in charge of VOA and also make him the Attorney General since he is one of the few that really understands what the constitution says. [Rohde-OH] Back with new shows after 10 years!

**Radio Paisano**, logged on 6925 in the AM from 2215 past 2249 UTC on October 13th I heard of them playing playful Italian music [Rohde-OH] Ye ed heard them signing off with the Italian National anthem, followed by the phrase "That's a spicy meatball!"

**The Wave** noted on 6925 USB 0006-0032 sign off on October 18th. Signed on with "Anchors Away" into "Ride Captain Ride," "Yellow Submarine," "Sail on Sailor," "Wooden Ships," with a couple of IDs and off with "The Class of 1907 March." One would think that this station has a nautical motif. Bravo Zulu The Wave! Possible address of POB 1, Belfast NY 14711. [Wood-TN]

**Victory Radio**, heard on 6925U 2345 sign on to 2355 sign off on October 11th. SIO=242. Anthem by band into a discussion of the football defeat of Oklahoma by Texas earlier this day, which is the purpose of the station. Oklahoma had been ranked #1 prior to this game. A blues tune played for the Oklahoma fans. Also played "Red River Valley." No address noted (Zeller-OH)

**WAHR-Automated Halloween Radio** 6925 USB. Heard from 2355-2359 UTC on October 17th. First log of this station. Recitation of "The Raven," and scary radio drama. Poor. [Wood-TN]

Many thanks to the following fine folks who contributed either direct or through the NASWA Flash Sheet: Mike Rohde-OH, Joe Wood-TN, George Zeller-OH.

Until next month, Happy Pirate DX!! 

# QSL Report

Sam Barto • 78 Blakeman Road • Thomaston, CT 06787

## VERIFICATION

We are pleased to verify your reception of World Harvest Radio.

Date: 10 July 2007 11:11 PM EDT

Time: 1045 UTC

Freq: 9920 kHz

Thank you for your report!

L. W. Uehorn

World Harvest Radio Engineering

STUDIO:  
41300 S. Ironwood Rd.  
South Bend, IN  
46614 U.S.A.

TRANSMITTER:  
Honolulu, Hawaii  
U.S.A.



Richard A. D'Angelo  
2216 Burkey Dr  
Wyonissing PA  
19610

Kind of a short QSL Column this month. Where did everybody go?... Sam.

### ABU DHABI: Radio Japan

13740 f/d "Fisherman" cd. in 120 ds. for an EG rpt. Addr: NHK World/Radio Japan, KHK Tokyo 150-8001, Japan (Wood-TN) Joe Wood reports that this is country #79 for him.

### BOLIVIA: Radio Mosoj Chaski

3310 f/d ltr. in EG (!) in 9 mos. for a taped rpt. and \$2.00. v/s Ann Wheeler. (Smith-MA).

### CHINA, PEOPLE'S REPUBLIC OF:

I received a commemorative card of the Olympics in 1 mo. Not a QSL but I'm glad to add it to my collection. (Field-MI).

**CUBA:** China Radio International 9790 via Habana f/d "Olympic" cd. in 1 mo. v/s Ying Jian asked for more reception reports. (Field-MI).

**ECUADOR:** HCJB 9745 received QSL for their English broadcast. I now have the cards I missed in the switch from English to Spanish. Also rcvd. personal ltr. (Field-MI).

**STATION NOTES:** Play Back International 6882 (Swiss Pirate) Email: playbackinternational@gmail.com Premier Radio 6265 Email: premierradio@yahoo.ie Radio Barcelona 1646 Email: radiobarcelona9@hotmail.com Radio Barones 1645 Addr: P.O. Box 73, NL-7160 AB Neede, Netherlands Radio Black Bird 6285 Email: blackbird@wanadoo.nl Radio Blue House 6370 (Finnish Pirate) Email: radiobluehouse@hotmail.com Addr: SRS Deutschland, Postfach 101145, DE-99801 Eisenach, Germany Radio Bobby 6306 Addr: same as Blue House. Radio B.O.A. 6275 Email: radioboaa@radio.am .... via PLAY DX.

## Radio New Zealand

Thank you for your report on our transmission on 11 Dec 2006 on frequency 1384.0 kHz/mHz, which we are pleased to verify.

1128-1213 UTC

Deke  
Chris  
Thank you for your report.  
Admin  
Log

Dale PARK



PLEASE NOT FOR STAMP REQUIRED

### GREECE: Radio Station

Macedonia  
7430 f/d folder, sticker and post cd. in 5 years and 2 mos. v/s Tatiana Tsoli. Addr: ERT S.A., Subdirection of Technical Support, PB 11312, 541 10 Thessalonika, Greece (Wood-TN).

SPORT IN NEW ZEALAND.

A nation with a great sporting history, New Zealanders are passionate over a wide variety of sporting activities.

P.3273



Postal Publications Limited  
P.O. Box 555 Hastings, New Zealand

**SPECIAL OFFER:** For all of you QSL collectors out there I have a very special offer: ten (10) different amateur QSL cards from either Japan, Germany or Russia with ten (10) different prefixes for only \$5.00 per country. If you order all 3 for \$15.00, I'll also include ten (10) additional USA QSLs with all different prefixes - all from different States. Please enclose 2 ms. with your order...Sam. You'll probably make more than your money back on Ebay...Sam.

ՀԱՅԱՍՏԱՆԻ ՀԱՆՐԱՊԵՏԱՆԻ ԱՌՁԱՐԱԿ  
PUBLIC RADIO OF ARMENIA

R

ՀՐՁ  
VOICE OF ARMENIA

ՀՀ, Երևանի, Լիպիկ Մուսինյանի 5  
e-mail: president@mediacenter.am  
pr@armradio.am  
www.armradio.am  
www.mediacenter.am

To Mr. Scott Harbour Jr.

This verifies your reception report on our transmission

Date: 26.3.2003

Time: 20.41-21.01 UTC

Frequency: 9960 Khz

QSL

**MEXICO:** XERTA Radio Transcontinental de America 4810 beautiful "Flag" cd. in 3 mos. (Field-MI).

**PERU:** Radio San Antonio 3375 f/d cd. in 4 mos. on my 5th try to the \* station. This is my Peruvian QSL # 121. (Field-MI).

**RUSSIA:** Voice of Russia 9665 f/d "St. Petersburg 300 Years" cd. in 11

**STATION NOTES:** Radio Television Malagasy 5010 v/s Mrs. Rakotoma Soa Herimanitia. Addr: Boite Postale 1202, Antananarivo. Radio La Hora 4857 v/s DXer Carlos Gamarra Mascoso, QSL Manager. Radio Amanecer Internacional 6025 Email: cabina@radioamanecer.org. Radio Verdes Florestas 4865 v/s Graci Rezende, Gerente.

Radio Bangladesh 4750 v/s Mahesh Chandra Roy, Senior Engineer Research and Receiving Center. KBC Radio 6255 via Sitkunai v/s Tom de Wit. Addr: Argonstraat 6, NL-6718 WT, Ede, Netherlands. Radio Condor 6310  
Email: condorrad  
io@hotmail.com  
...via PLAY DX.

Dear Friend, Thank you for your report which we herewith verify as fully correct. IBRA RADIO was heard over Deutsche Telekom Netz as follows:

Date: 24 July 2002  
Hour: 22.30 - 23.30 GMT  
Frequency: 9405 KHz (.....m)

Your interest in the IBRA RADIO broadcasts is much appreciated and we shall be glad to hear from you again.

IBRA RADIO



ds. for a FAXed rpt. Also rcvd. a very friendly letter from Elena Osipova. (Mikell-IL).

Ye Editor rcvd. a nice note from Marlin Field in which he said that he was pleasantly surprised to find that he had submitted close to half of the QSL reports in the last QSL Column. Congratulations Marlin, you increased your percentage this month...Sam.

Till next time ... best of QSLing.

Sam

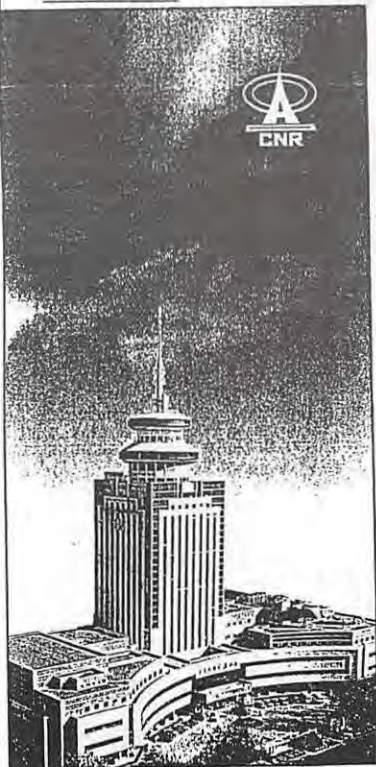

# Contributors' Page

Bob Montgomery • 4621 C Street • Philadelphia, PA 19120 • [rmonty23@verizon.net](mailto:rmonty23@verizon.net)

## DEADLINE FOR CONTRIBUTIONS IS THE 10th OF THE MONTH

The following members sent in contributions:

Brian ALEXANDER, Mechanicsburg, PA	TenTec RX-340 AOR AR-7030 100' LW
Scott BARBOUR, Intervale, NH	R8, R-75, MLB-1, 200' Beverage
Bruce BARKER, Broomall, PA	NRD-535D, Alpha Delta Sloper
Rich D'ANGELO, Wyomissing, PA	TenTec R340, Lowe HF-150, DX Sloper
Gerry DEXTER, Lake Geneva, WI	NRD-515, NRD-545, etón E1
Jerry ERVINE, Hidalgo, TX	R-75, R2000, 2010, whip & 5 band Vert, wire
Jim EVANS, Germantown, TN	RX340, Drake R8B, 30 m wire
Marlin FIELD, Hillsdale, MI	NRD545, long wire
Bob FRASER, Belfast, ME	Sony ICF-2003 ICF-SW100S 2m LW
Glenn HAUSER, Enid, OK	FRG-7, DX-398, SW-07, ATS-909, YB400 lw
Ron HOWARD, Monterey, CA	NRD545, LW 160', etón E5
Don JENSEN, Kenosha, WI	NRD-545, E1x, Alpha Delta Ultra
Stephen LEITE, Fall River, MA	no equipment listed
William McGUIRE, Cheverly, MD	DX-380
Enrico OLIVA, E. Northport, NY	Drake R8
Sheryl PASZKIEWICZ, Manitowoc, WI	NRD515, Eavesdropper
Mike ROHDE, Columbus, OH	Ten-Tec RX-340, Wellbrook ALA
Jim RONDA, Tulsa, OK	NRD-545, R75, etón E1, Eavesdropper
Mark SCHIEFELBEIN, Springfield, MO	Kenwood R-5000, Wellbrook 330S loop
Giovanni SERRA, Rome, ITALY	NRD-525 AD Sloper
Jerry STRAWMAN, Des Moines, IA	Perseus, R-8, 313e, 60 mtr dipole, mini whip
Mark TAYLOR, Madison, WI	R-75, Sat 800, EWE, Eavesdropper
Joe WOOD, Gray, TN	DX-390, Grundig Mini 100 PE, whip antenna 



## On the Short Waves



On the Short Waves by Jerry Berg

<[www.ontheshortwaves.com](http://www.ontheshortwaves.com)> Update, October 17, 2008—Under "DX History/Clubs & Publications," the New Zealand Radio DX League, in honor of this year's celebration of the club's 60th anniversary, has published a special supplement to the October 2008 New Zealand DX Times. It contains several interesting items about DXing in New Zealand: the very first issue (October 1948) of the New Zealand DX Times; "The Origins of DXing in New Zealand" by Barry C. Williams; a two-part article, The Great Mob, by Frank Glen; "My Great DX Hobby" by the late Jack Fox; Radio New Zealand International: The Voice of New Zealand, Broadcasting to the Pacific by Andrew M. Clark; and This Radio Age—The Biggest Little Programme in International Broadcasting, which summarizes the show's content for 1953. A higher resolution copy of the supplement (29.2 MB) may be found at <<http://www.worldfm.co.nz/radiodx.com/DXTimes/Supplement/>> Thanks to the NZRDXL for permission to post this interesting material on ontheshortwaves.

# Tropical Band Loggings

Scott Barbour • P. O. Box 893 • Intervale, NH 03845 • srbjrswl@yahoo.com

- 2310 **AUSTRALIA VL8A** Alice Springs 1203 Pop mx; //2325-Tennant Creek & 2485-Katherine; all about equal this AM; fair; 9/22. (Strawman-IA) 1230 ABC nx in EE; v. poor but readable; 9/24. (Ronda-OK) 1225 Pop mx prg; then ABC nx update by W ancr including a story about Christmas Island; //2325-similar strength; //2485-weaker though usually 2485 is the strongest here; fading rapidly; f-p; 10/9. (Schieffelbein-MO)
- 2325 **AUSTRALIA VL8T** Tenant Creek 0906 Lcl nx stories in EE followed by a story about the U.S. Presidential race; good; //2485 Katherine-poor; 9/22. (Taylor-WI) 1230 ABC nx in EE; poor; 9/24. (Ronda-OK) 1232 M & W presenting nx feature; poor; best of three 120m outlets; 10/3. (Strawman-IA) 1202-1220 Pop instrumental mx w/ EE ancments by M or W at approximately 3 minute intervals; poor; SINPO 24222; above the noise most of the time; //2310-Alice Springs; weaker sig & 2485-Katherine; much weaker sig; barely audible; my first log of these stations; 10/8. (Evans-TN)
- 2379.73 **BRAZIL R. Educadora** Limeira 0940-0950 Long talk in PP by locutor; no mx; 9/30. (Wilkner-FL)
- 2485 **AUSTRALIA VL8K** Katherine 1220 Rock/pop tunes w/ a couple of AM/FM IDs; then nx bulletin at 1230 w/ mix of nat'l/int'l & N. Territory nx; including widespread power outages in Alice Springs following severe storms; not enough to knock SW off the air though; //2310-VL8A also heard along w/ //2325-VL8T; 2310-fair; 2325-good; 2485-v.good; 9/22. (Schieffelbein-MO) 1225 Pop songs; ancments by W in EE; nat'l nx at 1230; sudden peaks to good; first time I've heard all three 120m NT stns at the same time; fair; 9/24. (Ronda-OK) 1309 (P); M & W in EE; 1310 mx; presumed but what else could it be?; PNG was in on 90m; Indonesia on 75m; also checked //2325 & 2310 but no other NT stns audible; there were however some misc. carriers which could have been something lcl; why does Katherine do so much better than the others?; is there something about its antenna or real power which give it an advantage? 9/26. (Hauser-OK) 1258 NT stns on 120m were all in & //; 2485 being slightly stronger than 2310; slightly stronger than 2325; tho all were reading about S9+10; W in EE; 1259 folk song continuing past 1300 w/ no break at BoH; 9/27 (Hauser-OK) 1252 VL8K best heard yet w/ armchair copy; relg discussion; much like on RA but not //9580; could be same show from so-called ABC Local Radio; but half an hour offset; //2325-VL8A was much weaker this time & //2310-VL8T even weaker; recheck 1321; half a sesquihour after lcl sunrise; still just barely audible on 2485 w/ talk; I wonder if any Aussie sigs would have been coming thru too on the upper MWBC band if not blocked; 9/28. (Hauser-OK) 1248 Another morning; another check of 120m NT VL8 stns; W & M discussion show in //2485 best; then 2310; then 2325; 9/29. (Hauser-OK) 1219 TP condxns were not so good but all three VL8 stns were audible in // w/ 2485 best; 10/1. (Hauser-OK)
- 2850 **N. KOREA KCBS** Pyongyang 1202 Usual propaganda; poor but clear sig; 9/22. (Strawman-IA) 1120 (P); M w/ KK talk into usual Korean "heroic" opera; fair; 9/30. (Taylor-WI) 2850.03 2137-2203 Talk & ancment; lcl choir lyrical chants; f/ out from 2153 -2158 then heard w/ v. weak audio; heard in SSB w/ NIR12; QRM & cont. QRM similar to a fast motor engine & sporadic USB ARO's in Slavic lang; poor-v. weak; 10/4. (Serra-Italy)
- 3173.32 **PERU R. Municipal** Panao 0015 (P); Presumed the OA here; 10/14. (Wilkner-FL) 3173.80 0730 (P); Possibly the one noted; seems early; again at 0830 recheck; 10/13. (Wilkner-FL)
- 3185 **USA WWRB** Morrison 1216 I had thought that Brother Scare via WWRB was on one txmitter; switching around 1300 from 3185 to 9385; but 1216 I found two different B.S. prgs running & both freqs on at once; our cup overfloweth; 10/1. (Hauser-OK) 1241 WWRB's FCC sched has been revised to show the 340 degree antenna changing from 3185 to 9385 at 1200; nevertheless both were on the air; but not //; R. G. Stair not speaking at the moment but presumably The Overcomer Ministry anyway; 3185 was much better than 9385 at this time as higher bands had not yet opened up, e.g. WWCR 7490 & 9980 nearby geographically also poor; at 1249 Stair himself had started talking on the 3185 Sabbath b/cast; UT Sunday at 0132 found dead air on 3185; but not for long; pauses lasting from 6 to 15 seconds were interrupted by unintelligible screaming; usually in two smaller segments; Occ. the preacher lapsed into quasi-normal speech; so that at 0144 I could make out that he was referring to I Thessalonians:Ch 1 ;which looks like boilerplate to me; nothing special to quote; refute or ridicule; 10/4-5. (Hauser-OK)
- 3205 **PNG R. West Sepik** Vanimo 1302 Noted what sounded like a NA; then OC so I figured R. West Sepik had s/off; but 1304 talk resumed; 9/26. (Hauser-OK) 1224 Pop mx & rap mixture partially blocked by huge het near freq; 9/27. (Strawman-IA)

- 3220 **ECUADOR HCJB** Pifo 0750 Off but back at 0800 recheck; 10/3. (Wilkner-FL) 0120 (P); Mx & unid. lang.; so I first thought of Africa; but must be only HCJB in Quechua; supposedly NVIS; BTW the 90-degree "azimuth" shown in Aoki means straight up; not due east! WWCRC does not open 3215 until 0200; fair; 10/4. (Hauser-OK)
- 3235 **PNG R. West New Britain** Kimbe 1245 M in Tok Pisin; poor; 9/24. (Ronda-OK) On 9/25; fair at the same time. (Ronda-OK) 1221 Fair sig w/ pop mx; moved s-meter on peaks; 9/27. (Strawman-IA) 1155 Talk prg to 1200; break for apparent nx then into mx w/ anc chat & ments. of PNG; peaking around 1220; normally one of the weaker PNGs here; fair at peak; 9/28. (Schiefelbein-MO) 1130 Island-type mx w/ M anc cmntary Seemed to be //3365; which was also audible; but was definitely not //3335 which had a spoken-word prg at the time; poor but improving; 10/11. (Schiefelbein-MO)
- 3240 **SWAZILAND TWR** Manzini 0325 Relg prg in Shona; fair; 9/30. (Ronda-OK)
- 3250 **HONDURAS R. Luz y Vida** San Luis 0120-0126 (P); SS talk w/ mx; poor; 9/30. (Rohde-OH) 0121 Ancr in SS w/ birthday greetings to someone in Guatemala; I see this stn is missing from Aoki listings' tho quite regularly rpted; EiBi has it; 10/4. (Hauser-OK)
- 3255 **S. AFRICA BBC** Meyerton 0420 Prg of Afropop songs & comments in EE; fair; 9/26. (Ronda-OK)
- 3260 **PNG R. Madang** Madang 1152 Talk by M in Tok Pisin; f/in at 1152; reaching poor lvl by 1156; mx at 1158 & back to talk; off as per sked at 1200; 9/27. (Ronda-OK) 1200 A bit of mx I recognized as the PNG MA; then off the air after a few moments of OC; poor; 10/8. (Schiefelbein-MO)
- 3303U **CHINA Zhoushan Maritime Meteorological Radio** \*1401-1411\* S/on w/ Kenny G mx; CC w/ (P) maritime wx condxns; p-f; noted w/ 1412 s/off on 9/28; not heard at all on 10/1-2; believe they must have changed their sked again; website: <http://220.189.205.5/default.asp>; 9/30. (Howard-CA)
- 3310 **BOLIVIA R. Mosoj Chaskis** Cochabamba 0150 Songs; into talk in Quechua at 0157; fair; 9/30. (Ronda-OK) 0038 Best ever w/ talk by W; 10/5. (Paszkievicz-WI) 0057 Talk by M in Quecha to 0100 off; odd ute tonal sig followed; like a single note on a vibraphone; tnx to S. Paszkiewicz for the tip; fair; 10/5. (Taylor-WI)
- 3320 **S. AFRICA R. Sondergrense** Meyerton 0255 Two M ancrs in Afrikaans; pop songs in EE; ID at 0300; good; 9/25. (Ronda-OK) 0130-0135 (P); Prg in Afrikaans; poor; 9/30. (Rohde-OH) 0125-0132 (P); Pop mx; W & M w/ talk; QRN strong static & QRM cont. noise similar to a fast motor engine covering all 90m; (P) QRM not here at my QTH; best in SSB; poor w/ NIR12; 10/4. (Serra-Italy) 0300 Prg in Afrikaans; fair; 10/5. (Rohde-OH) 0309-0400 W w/ pop mx; ID & into nx at ToH; v. strong sig hampered by static; fair; 10/8. (Wood-TN)
- 3325 **INDONESIA-C. KALIMANTAN RRI Palangkaraya** et. al. 1258 (P); Trans-Pacific condxns were hot; so I kept tuning around; unable to land on any one freq long enough to get much detail; but I'm not trying to QSL them, anyway; 1258 talk then mx; 1304 mx; could be PNG here tho not certain; 3987 1255 talk; 1305 Indo talk //3995; 1323 hams relented a bit; mx sounds similar to 3995 but not //; 1325 definitely different mx; 3995 1255 mx; 1305 Indo talk //3987; 1323 similar mx to 3987 but not same; 1325 ham net starts up on 3995 w/ this as BFO: 4605 1314 mx; v. weak but evidence Serui is still on the air; 4790 1310 mix CODAR & mx then W ment. FM; kHz; somewhat better than 4750 which also had SCI' 1312 W vcl on 4790; no more Qu'ran; takes Sundays off? Ramadan not quite over; 9/28. (Hauser-OK)
- 3329.53 **PERU Ondas del Huallaga** Huanuco 0240-0300\* M anc & mx; weak using LSB w/ CHU notched; 10/4. (Wilkner-FL) 3329.62 1000 Weak sig noted here; 9/25. (Wilkner-FL)
- 3335 **PNG R. East Sepik** Wewak 1237 (P); Island-type mx & M anc poking out of the noise; a surprisingly weak showing from PNG this morning despite good reception from its neighbors; poor; 9/22. (Schiefelbein-MO) 1237 S5 sig mixing with t-storm static; mix of po/CW/island mx; 9/26. (Strawman-IA) 1305 (P); Best presumed PNG sig this morning w/ mx & (P) EE talk; 3325 had some mx but that could also be Indonesia; but nothing from PNG on 3365 or 3385 so they were off; 9/26. (Hauser-OK) 1140 M in Tok Pisin; improving toward 1200; on 9/24 did not f/in until 1213; poor; 9/27. (Ronda-OK) 1034-1108 M anc w/ lengthy; animated talk in Tok Pisin thru ToH; ballad at 1104; brief W anc at 1107 followed by island mx; fair-fading by ToH; 9/28. (Barbour-NH) 1230 "Island" mx; poor; 10/3. (Strawman-IA) 1110 W in Tok Pisin; 10/8. (Dexter-WI)
- 3340 **HONDURAS HRMI** Comayaguela 1147 M & W in SS; noted most mornings this week; fair; 9/25. (Ronda-OK) 0508-0528 Familiar format w/ M preaching in EE & W providing phrase-by-phrase SS translation; it sounded like she was working from a script; ments. of the Books of John; Philipians; Psalms & Hebrews; fair; 10/1. (Wood-TN)
- 3345 **S. AFRICA Channel Africa** Meyerton 0353-0412 EE features w/ 4+1 time pips at 0400 followed by TC; ID & nx; another ID at 0407 followed by lcl nx & sports; fair; 9/25. (D'Angelo-PA) 0401-0406 W "Amanda" w/ nx of the UN & several items on S. Africa; QRM from REE-Costa Rica on 3350; v. strong sig hampered by static; fair; 10/8. (Wood-TN)
- 3350 **COSTA RICA REE** Cariari 0556 Mixing REE IS w/ regular prgrmg which also included some mx; until both went off at 0600. Is no one paying attention? 9/30. (Hauser-OK) 0200 Follow-up to monitoring during the UT 10/3 Vice Presidential debate; after 0200 I could hear 3350 poorly but the other freqs Spain adds at this hour were not making it; 10/3. (Hauser-OK)

- 3365 PNG R. *Milne Bay* Alotau 1236-1246\* Relay on NBC prgrmng in EE; pop songs; on-air calls w/ mx dedications; gives phone numbers & NBC email address; suddenly off; 10/11. (Howard-CA)
- 3385 PNG R. *East New Britain* Rabaul 1218 Beginning to f/in w/ M in Tok Pisin; never got beyond poor lvl; 9/27. (Ronda-OK) 1246 An American-accented M talking caught my ear; but quickly back to W w/ less comprehensible PNG accent; at first I thought it might be a mixing product; this was the best sig of the usual crew on 90m; 9/29. (Hauser-OK) 1217 W ancrr in Tok Pisin w/ pop mx; S5 sig on peaks; 10/3. (Strawman-IA)
- 3912 N. KOREA 1259 Usually too blocked by SSB hams; but I was able to make out some mx accompanied by jamming; i.e. V. of the People from South to North & deliberate interference from North to North; both reaching here to what the Koreans could justifiably refer to as the "Far East"; 9/29. (Hauser-OK)
- 3925 JAPAN R. *Nikkei* Tokyo-Nagara 1257 R. Nikkei was missing from JOZ 3925; but back on with synthesized classical mx 9/29 at 1251 check; yes per WRTH 2008; 3925; 6055 & 9595 s/off early at 1200\* on Sundays; otherwise to 1330\* except Fridays to 1430\*; 9/27. (Hauser-OK)
- 3976 INDONESIA-W.KALIMANTAN RRI *Pontianak* 1254 The 75m trio were all audible: 3976 w/ Indo talk by W; not // something on 3987; 3995; ham QRM worse the further into "80m"; such that at 1256; 3995 was QRM-free; on 60m; 4790 was back to Kor'anng at 1302; 4750 mx rather than nx/talk; 9/29. (Hauser-OK) 3976.04 1340-1355 Good recep'n; //3325-weak; after 1355 not //; 9/30. (Howard-CA)
- 3980 UNIDENTIFIED 1255 Vcl mx struck me as S. Asian w/ ham QRN; buzzing; hets on & off; 1256 ancrrnt; 1306 mx; PWBR has Hamgyong PS, KOREA NORTH on 3981v; as alternate to 3940 & I did not nail it to 3980.0 for sure; Aoki has nothing b/w 3976 & 3985; but 3940 Chongjin; LOB in Brasil has been rptng N. Korea on 3980 about 3-4 hours earlier; 9/28. (Hauser-OK)
- 3985 CROATIA *Hrvastki Radio* Deanovic 0108 (P); W ancrr in Croatian; mellow ballad; M ancrr w/ lively talk; f-p w/ ARO QRM; 9/30. (Taylor-WI) 0307 Prg in SS; poor; 10/5. (Rohde-OH)
- 3987 INDONESIA RRI *Manokwari* 1206 Best ever rcption made it easy to distinguish b/w M & W ancrr doing (P) nx; 3976-Pontianak not heard at this time; 9/22. (Strawman-IA) 1301 Weak mx & slightly on high side; that matches the measurement by J. Wilkins of reactivated RRI Manokwari on 3987.05; also something on 3995; another Indo likely; 9/26. (Hauser-OK) 1301 In //3995 M talking; (P) nx via Jakarta; poor; also noted on 60m at 1306; 4750 Best w/ Indo talk; same on 4790; 1307 mx on 4870; 9/27. (Hauser-OK)
- 4409.85 BOLIVIA R. *Eco* Reyes 2350 Noted here w/ weak sig; 10/9. (Wilkner-FL)
- 4451.17 BOLIVIA R. *Santa Ana* Santa Ana de Yacuma 2350 Noted here w/ weak sig; 10/9. (Wilkner-FL)
- 4604.86 INDONESIA RRI *Serui* 0946 (T); Noted w/ threshold sig; 9/30. (Wilkner-FL)
- 4699.29 BOLIVIA R. *San Miguel* Riberalta 2350 Strong sig; stronger at 0900 this lcl morning; 10/9. (Wilkner-FL) 4699.34 \*0855 Locutor w/ TC & freq giving kiloHertz; 10/10. (Wilkner-FL) 4699.36 0142-0157\* W & M in SS; fast lcl sig at 0147; again W & M; final ancrrnt; no ID noted; s/off at 0157; QRN strong static; fast QSB; best in USB w/ NIR12; poor; 10/4. (Serra-Italy)
- 4699.4 BOLIVIA R. *San Miguel* Riberalta 1012 ".en la hora mas mundial. Radio San Miguel...Bolivia..."; 9/18. (Wilkner-FL) 0312-0325\* M & W w/ frew info; "banda de 60 metros" into "Los Sonidos del Silencio" as s/off musica; similar to Jose Feliciano; strong sig; 9/28. (Wilkner-FL)
- 4716.6 BOLIVIA R. *Yura* Yura 0132 M w/ talk; poor; still poor at 0143 recheck; 9/26. (Ronda-OK) Also at same time on 9/27. (Ronda-OK) 4716.63 2350 Mx; good sig; 10/9. (Wilkner-FL) 4716.70 2335-2355 SS talk; Bolivian flute mx; weak but readable; 10/3. (Alexander-PA) 2347-0002 Ancrr w/ SS mx & talk; ID at ToH; poor but improving; 10/7. (Barbour-NH) 4716.19 2300 Exc. Andean mx; good; 10/9. (Wilkner-FL)
- 4739.53v VIETNAM RTV *Son La* Son La 1348-1400\* (P); Indigenous VV mx & singing/chanting; audio quality varies from day to day; today was somewhat mushy; f-p; 10/10. (Howard-CA)
- 4750 BANGLADESH *Bangladesh Beta* Shavar 1448-1501 (P) SC mx & singing; p-f; best in USB; QRM from the low side was probably RRI &/or China; 10/4. (Howard-CA)
- 4750 INDONESIA RRI *Makassar* 1133 M & occasional W ancrr b/w lcl-sounding tunes; followed by long one-on-one intrvw; fairly strong sig fighting w/ stronger CODAR; good otherwise; 9/22. (Schiefelbein- MO) 1225-1246 Indo talk & variety of EZL mx; always the first 60m Indo to appear on the band; fair; 9/23-25. (Ronda-OK) 1258 The dominant one w/ 4790-Fak Fak hardly audible; 4750 had a string of promos in Indo; 1300 M & W talking w/ lots of Salaam-Aleikum; 1303 into Qu'ran; there was a rippling SAH from a weaker stn; either China or Bangladesh; 9/24. (Hauser-OK) 1240 M apparently speaking in front of crowd; S6 on peaks; 9/26. (Strawman-IA)
- 4760 ANDAMAN & NICOBAR ISLANDS AIR *Port Blair* 1449-1501 EE coverage of speech made by Indian PM Singh at UN General Assembly today; covering a wide range of topics; "The United Nations is a living symbol of pluralism"; weak; //4880-Lucknow; 5010-Thiruvananthapuram & 9425-Bangalore; 9/27. (Howard- CA)

- 4828 **ZIMBABWE ZBC** Gweru 2330-2338 Mx; f-g sig; 9/22. (Wilkner-FL) 2257 Mx; fair sig; again at 0050 w/ weaker sig; nothing on 3396; 9/26. (Wilkner-FL) 0125 Lots of pop vcls; good & again at 0414 recheck; 9/26. (Ronda-OK) 0230-0250 Vcls & instrument mx; 3396 in only as a carrier at same time; 9/30. (Wilkner-FL) 0423-0441 (P); Non-stop mx prg of lcl vcls; fair w/ some CODAR QRM; 10/1. (D'Angelo-PA) 0131-0207 Lots of African mx w/out a break; major static; poor; 10/2. (Rohde-OH) 2356-0006 (P); Cont's hilife mx; no ID/ancments noted; poor w/ occ. ute QRM; first time in months this one hasn't been covered by CODAR or a ute here; 10/7. (Barbour-NH) 4828.1 0105 Choral mx; poor; 9/16. (Ronda-OK)
- 4830.72 **UNIDENTIFIED** 1040-1100 Threshold sig; 9/27. (Wilkner-FL)
- 4835 **AUSTRALIA VL8A** Alice Springs 0750-0825 Variety of prg's heard; //4910-VL8T also noted; 120m stns weak after 0830 w/ 2325 the strongest; 10/3. (Wilkner-FL)
- 4835.5 **PERU R. Marañon** Jaen 0327 Unaccompanied singing; talk in SS at 0328 & back to songs; poor; 10/4. (Ronda-OK) 4835.55 \*0958-1015 Carrier prior to s/on w/ SP mx; anc at 1000 & canned ID ancment; talk over mx until mx from 1006 thru t/out; p-f at best; 9/16. (Barbour-NH)
- 4840 **INDIA AIR Mumbai** 1243 Hindi vcls just above the noise lvl; poor; 10/3. (Strawman-IA)
- 4845.24 **BRAZIL R. Cultura Ondas Tropicais** Manaus 0125-0210 Light mx; M ancment & (P) ID at 0134; M & W ancrs b/w musical selections; best heard in SSB; QRN static & QRM CODAR plus sporadic strong utes; p-f w/ NIR12; 9/10. (Serra-Italy)
- 4845 **MAURITANIA R. Mauritanie** Nouakchott 0600 I often check after 0600 for R. Mauritanie; usually it isn't there; but it was today w/ soporific chanting; just what I need; unlike the morning crowd over there; maybe because it was Friday; ToH w/ Ramadan; people may stay up all night feasting & then go to bed at sunrise since you can't eat all day; anyway; 9/19. (Hauser-OK) 2331 AA talk; good; 9/30. (Rohde-OH) 0118 Speech in AA; strongest stn on band below 5 MHz; was not listening closely but went off somewhere around 0130; however at 0156 check there was still a carrier on about 4845.2, maybe this; 10/4. (Hauser-OK) [4845.2-Brazil perhaps?-ed.]
- 4885 **BRAZIL R. Difusora Acreana** Rio Branco 0135-0145 Prg in PP; beacon on a near freq; fair; 9/30. (Rohde-OH)
- 4885 **BRAZIL R. Clube do Para** Belem 0416 LA versions of Hip hop tunes; standard reverb fx w/ M ancr who sounded like he might be new; good; 10/8. (Wood-TN) 4885.01 0204-0224 M w/ PP talk; a mix of ancments; jingles; ads & mx breaks; mx; 2 M talking ment. ".do Para."; best in LSB w/ S9+ 15 of peak; fast QSB & slight static; both almost nulled w/ NIR12; f-g; 9/27. (Serra-Italy) 0402-0416 Cont. lcl ballads; M w/ IDs; freq ancment at 0415 & cont. mx prg; best heard in SSB w/ S9+ 10 of peak; slight fast QSB & static; fair; 9/30. (Serra-Italy)
- 4855 **BRAZIL R. Por Um Mundo Melhor** 0530-0540 (T); Mx; QRM via beacon on 4883; ID not heard; 9/20. (Rohde-OH) [What is this? This one isn't listed, either current or inactive, in any DX listings I use-ed.]
- 4865 **BRAZIL R. Alvorado** Londrina 1049 Talk in PP; beginning to fade by 1055; ID at 1058; fair; 9/20. (Ronda-OK)
- 4870 **INDONESIA RRI Wamena** 1245 Pop mx prg; low modulation on S6 carrier; 9/26. (Strawman-IA)
- 4885 **BRAZIL R. Difusora Acreana** Rio Branco 0004 (P); "Renaldo!!!" gaining control of the ball; PP coverage of soccer game w/ Renaldo making a goal; I was unable to find a // Difusora ntwrk stn audible to see if soccer was on the whole ntwrk; as I have heard in the past; fair; 9/25. (Taylor-WI)
- 4900 **CHINA UNIDENTIFIED** 1226 Getting more on 60m from China; than from Indonesia; W w/ song in EE; into CC ancment; also sigs on 4830; 5050 & strongest on 5030 but always w/ SAH & QRM from Malaysia; 10/1. (Hauser-OK)
- 4904.95 **CHAD RNT** N'djamena 2225 Lcl mx w/ FF cments; NA at 2231; audio out 2232:30; 9/26. (Strawman-IA) 4904.97 1919-1940 Afropops w/ M Dj in FF; laughter; diff. M ancment w/ ID into W reading nx w/ correspondents; best in LSB; het & QRN static; QSB; fair; 9/30. (Serra-Italy) 2220-2232\* Afropop mx; FF ancments; s/off w/ NA but pulled plug midway thru anthem; f-g; 10/2. (Alexander-PA) 4905 0534 M & W in FF w/ (P) interview; 0548 new mx prg; fair; 9/20. (Rohde-OH) 2200-2230 M & W ancr in FF; RNF ID at 2330; 9/24. (Wilkner-FL) 0600 W ancr into exotic Tchadienne mx; 9/25. (Wilkner-FL) 0510-0522 M w/ pure talk prg in FF; S9/vg; 9/27. (Wood-TN) 2206-2220\* Mix of hilife vcls & FF talk by M ancr but carrier terminated suddenly at 2220 & never returned; someone wanted to get home early? good; 10/7. (D'Angelo-PA)
- 4905 **BRAZIL R. Anhanguera** Araguaína 0235 (P); Pop mx; poor-rushing white noise spoiled sig; 9/30 (Strawman-IA) 4905.06 2331 M w/ PP mx at s/of Chad; 9/24. (Wilkner-FL)
- 4905 **TIBET Xizang PBS** Lhasa 1130 Noted here; //4920; good; 9/24. (Wilkner-FL)
- 4914.6 **BRAZIL R. Anhanguera** Goiania 0010 Acapella whistling a song; M w/ PP talk; ballad; 0030 ID; poor; 9/25. (Taylor-WI)
- 4914.96 **BRAZIL R. Difusora** Macapa 0233-0303 M w/ PP mx & talk; ancment & ID ment. "Macapa" twice; heard in LSB w/ static & fast QSB; poor-almost fair w/ NIR12; 9/27. (Serra-Italy) 0417-0435 Lcl romantic song; M ancment & talk; mostly unclear w/ strong static crashes from 0420; another

- 4769.96 **NIGERIA R. Nigeria Kaduna** 2051-2101 Two M w/ talk; about 1 min s/on only from 2053 then on air again w/ pop song; mx pause & M ancrnt w/ (P) ID & nx; QRN static crashes; best in LSB w/ NIR12; poor; 9/27. (Serra-Italy) 4770 0453-0531 Song "Pretty Woman" to drums IS at 0459; M ancr w/ EE TC & ID at 0500; "The time is 6 o'clock; you are tuned to Radio Nigeria, Kaduna. The news read by Mohammad..."; ID at 0505 followed by more nx; ending at 0514 w/ ID followed by cont. vcls until another ID at 0529; fair but modulation was somewhat muffled; 9/20. (D'Angelo-PA) 2235 Lcl mx squeezed by RTTY & heavy storm static; poor; 9/22. (Strawman-IA)
- 4775 **INDIA AIR Impfal** 1239-1302 (P); Mx prg in lang.; f-p w/ CODAR QRM; 9/22. (Howard-CA) 1320-1401 Intrvw in lang; into a radio drama/soap opera; some SC mx; 9/23. (Howard-CA) 1520-1539 Nx in vern.; BoH "The news at nine" in EE; am glad to finally have positive confirmation that the stn I have recently been hearing here is in fact AIR; //4760 Port Blair-weak but clear; 4970 Shillong-fair w/ about a 3-4 second delay; 4990 AIR Itanagar-weak but clear & 9425 Bangalore-good; 10/10. (Howard-CA)
- 4775 **SWAZILAND TWR Manzini** 0348 Vcl mx in listed Lomwe lang.; good sig spoiled by RTTY; 9/27. (Strawman-IA) 0403-0440 GG relg talk by M w/ choir vcls; ID at 0429 into EE relg prg; f-g w/ slight CODAR QRM; 10/3. (D'Angelo-PA) 0409 M ancr in GG w/ baroque Christian mx; fair; 10/8. (Wood-TN)
- 4780 **DJIBOUTI RTD Atta** 2130-2200 Exotic mx; off w/ anthem?; strong sig; Ramadan ends 9/30?; 9/26. (Wilkner-FL) 2130-2201\* AA talk; lcl HoA mx & some w/ a Mid-East sound; s/off w/ NA; p-f but w/ CODAR QRM; 9/27. (Alexander-PA) 0426-0435 Cont. chanting in Mid-East style; better heard in SSB; QRN statics; fast QSB & strong CODAR; f-p; 9/30. (Serra-Italy) \*0300-0330 Islamic recitations; into M talk & mx; good; 10/1. (Wilkner-FL)
- 4780 **GUATEMALA R. Cultural Coatan** San Sebastian Off the air; 9/25. (Wilkner-FL) [Nothing noted for weeks here in NH-ed.]
- 4781.57v **UNIDENTIFIED** 1107 S/on w/ subdued audio; 9/25. (Wilkner-FL) 4781.65 \*1108 Seemingly too strong for a CP; noted daily; 9/29. (Wilkner-KM/Cedar Key FL)
- 4790 **INDONESIA RRI Fak Fak** 1217 Light pop mx; Koran chanting at 1251 recheck; poor; 9/23. (Ronda-OK) Also heard in this time period on 9/24. (Ronda-OK) 4790.02 [UTC?-ed.] Qur'an recitation reached S6 on peaks; but was marred by CODAR sweeps; [date?-ed.] (Strawman-IA)
- 4790.04 **PERU R. Vision Chiclayo** 0219-0257 (P); M & W w/ Halleluia & Alegria; mx break & M talk; best heard in LSB; het till 0241 & strong CODAR; any utes or jamming? sounded like a jet stream overwhelming Peru from 0256; p-f; 9/14. (Serra-Italy)
- 4796.47 **PERU R. Mallku Uyuni** 1015-1020 CP mx & cments de banda de 60 metros; 10/12. (Wilkner-KM/Cedar FL)
- 4799.7 **GUATEMALA R Buenas Nuevas** Huancayo 1135 Echo chamber effect in giving ID as Radio Buenas Nuevas; 9/26. (Wilkner-FL) 4799.9 1002-1007 Instrumental mx at t/in; full SS ID ancrnt at 1003; mx & talk thru t/out; p-f; 9/28. (Barbour-NH)
- 4800 **CHINA CNR-1** Beijing 1211 Live coverage of the closing ceremony of the Beijing Paralympic Games; f-p; 9/17. (Howard-CA)
- 4800 **MEXICO XERTA** 1100-1130 "We are the World" cover en español; exc. sig; 9/26. (Wilkner-FL) 0700 Mx; sermon attacking China; 9/29. (Wilkner-FL) 0726-0805 Long talk in SS by m w/ brief mx at 0740 & W ending prg segment; numerous ments. of Mexico prior to several IDs before some pop mx vcls; another ID at 0800; fair; 10/1. (D'Angelo-PA) 0530-0621 Cont's. mx during the entire rcption w/ the exception of an ID at 0616 as "Onda Corta X-E-R-T-A Radio Transcontinental."; the mx appeared to have been recorded before a live audience & included some EE in the performer's crowd comments; first log of this stn; poor; 10/11. (Wood-TN) 0440-0450 "Discussion of R. Buenas Nuevas" & R. Cultural, Guatemala; interference discussions?; R. Cultural Coatan has been off; 10/12. (Wilkner-FL)
- 4815 **BRAZIL R. Difusoor** Londrina 0010 Lively talk in PP; poor; 9/16. (Ronda-OK)
- 4820 **TIBET Xizang PBS** Lhasa 1211 Relay on CNR-1 w/ live coverage of the closing ceremony of the Beijing Paralympic Games; this was not // to other Tibet freqs; after 1330 was not //; 9/17. (Howard-CA)
- 4824.49 **PERU LV de la Selva** Iquitos 1038-1045 Musica andina; weak; 10/10. (Wilkner-KM/Cedar Key FL)
- 4825.2 **BRAZIL R. Educacao Rural** Tefe 0140-0201\* "Amazing Grace" on flute under W w/ relg talk; M w/ prayer & brief choral liturgy at 0150; continued w/ relg prgrmg; mostly mellow Gospel mx; M & W at closedown; 9/21. (Jensen-WI)
- 4826.4 **PERU R. Sicuani** Sicuani 0933 (P); M & W ancr w/ SS talk & mx; v. poor & quickly gone under band QRN; not much to work with; 9/16. (Barbour-NH) 4826.44 1010-1030 Mx bridge into locator w/ atenciones; TC's, cinco y diez, more atenciones; good sig in AM using Ecliptic Amplified Low Pass Filters to clarify audio; atenciones heard less often in the age of cell phones & the internet; 9/30. (Wilkner-FL) 4826.45 1031 Programa "central de...instituto...en las vista..."; some deep fades; 9/22. (Wilkner-FL) 4826.48 0931 (P); Anrc w/ SS mx & talk; v. poor; 9/28. (Barbour-NH) 4826.53 2310 Mx; stronger sig than earlier in the week; het from 4828-Zimbabwe; 10/3. (Wilkner-FL)

- romantic song; best in SSB; f-p; 9/27. (Serra-Italy) 4915 0755-0805 M anc in PP w/ Brazilian pops; fai at ToH then fading; 10/7. (Oliva-NY) 0417-0425 PP ID by M into soft pop mx; some of which was in EE; sweeper QRM; fair; 10/8. (Wood-TN)
- 4920 **INDIA AIR Chennai** 1221 Hindi vcls; peaked at S6; p-f; 10/3. (Strawman-IA) 1415-1431 Ads & SC songs in vern.; BoH ID for AIR; almost fair; totally dominating co-ch. Tibet (/4905) on this freq; normally Tibet has better rption; 10/5. (Howard-CA) 1348 Tibet well heard w/ v. weak AIR under them; have not yet heard the RRI reported hear; 10/6. (Howard-CA)
- 4920 **INDONESIA RRI Biak** 1235 F/in w/ Indo talk at 1235; improving to fair lvl by 1245; 9/25. (Ronda-OK) 1236 (P); Muffled audio of M in extended talk mixing w/ Hindi mx underneath; (P) AIR Chennai; overall jumble p-f; 10/12. (Strawman-IA) 1302 Warta berita; still going at 1307 & not //4790-Fak Fak; so must be RRI Biak; aside it a weaker carrier which could be Jambi; BTW, I remember hearing Biak when it was still under Dutch control; Netherlands New Guinea was in a disputed transitional period 1959-1969; finally becoming fully part of Indonesia; 10/12. (Hauser-OK)
- 4920 **UNIDENTIFIED** 1225 V. weak sig w/ mx that was both pop-like at times & had Hindi style characteristics on subsequent cuts; have heard Chennai here before; but Jambi possible; 9/22. (Strawman-IA)
- 4924.9 **BRAZIL R. Educação Rural Tefe** 0033 (P); M in PP; joined by several other M ancns; probably talking sports; poor; 9/25. (Taylor-WI) 4925 0158 Caught at s/off in PP; gone by 0201; poor; 10/4. (Ronda-OK) 4925.15 0017 (T); M w/ lively PP talk; probably a call-in; poor; recheck at 0135 showed mellow mx; fair; 9/21. (Taylor-WI) 4925.2 0153-0201\* Soft instrumental mx followed by M & W in PP; diff. M over soft piano mx; at 0200 brief SFX followed by another M anc w/ ID & freq ancment w/ carrier cut immediately after; fair; 9/20. (D'Angelo-PA) 4925.2 0035 M in PP; better at 0144 recheck w/ soft mx & ancments by W; poor; 9/21. (Ronda-OK)
- 4925 **INDONESIA RRI Jambi** 1326-1341 Islamic singing/chanting in Bahasa Indo; weak; 9/30. (Howard-CA) 1426-1450 (P); DJ in Bahasa Indo playing pop SC mx & songs; w/ on-air calls ("Hello, hello ..."); QRM from some type of data txmission; poor but the best rption so far this DX season; tnx again to T. Ashar for providing the solid ID for this stn; 10/9. (Howard-CA)
- 4930 **BOTSWANA VOA Moepeing Hill** 0352-0411 W w/ rpt about country singer in closing segment of "VOA World News Now" prg; at 0358 was "This Day in History" segment; ID at 0400 followed by "Daybreak Africa" prg; fair; 9/18. (D'Angelo-PA) 0426-0441 M w/ EE talk of athletics in Liberia; talk of the Zimbabwean Cabinet being in turmoil; prg ID as "Daybreak Africa" & VOA ID; fair; //4960 Sao Tome-good; 10/8. (Wood-TN)
- 4940 **UNIDENTIFIED** 1315 Fluttery carrier averaging S9+10 which ought to be enough for copy; but just bits of talk audible; so very undermodulated? (P) AIR Guwahati; 1317 similar flutter on weaker 5050 sig; Aizawl? but talk sounds more SE Asian & more likely China; 9/28. (Hauser-OK)
- 4945 **UNIDENTIFIED** 1305 Fluttery carrier; but no modulation audible; I figured it was AIR Guwahati; but that is supposed to be on 4940; so one of us may have had the wrong freq; 9/27. (Hauser-OK)
- 4955 **PERU R. Cultura Amatua** Huanta 0135 (T); W w/ singing & chanting by M & alto W accompanied by Andean primitive instruments; possibly prayer sequence; no apparent ID at ToH; off abruptly at 0202; tnx to D. Jensen for the tip & J. Strawman for the assistance; poor; 9/25. (Taylor-WI) 2340-0005 (T); Cont. SS talk; v. weak; 10/3. (Alexander-PA) 0011-0020 (P); Anc w/ SS mx & talk; v. weak-poor; 10/7. (Barbour-NH)
- 4955 **PERU R. Madre de Dios** 0158 (P); Only bits & pieces of words and songs; steadily improving by 0200 w/ W talk; off at 0202; others in our listening group heard more details to ID this as R. Madre de Dios; I can only list it as presumed & tentative; 9/26. (Ronda-OK) [I'm intrigued. LA SW Logs site lists this one on 4949.9v-ed.]
- 4960 **SÃO TOME VOA Pinheira** 0405 Nx in EE; fair; 9/18. (Ronda-OK)
- 4965 **ZAMBIA CVC Lusaka** 0125 Usual mx prg in EE; good; 9/26. (Ronda-OK)
- 4970 **INDIA AIR Shillong** 1430-1456 "This is the North Eastern Service of All India Radio broadcasting from Shillong on 60.36 meters on shortwave, corresponding to 4,970 kHz."; "Good evening. Hello listeners in the North East" gives phone number to call-in; bubbly DJ; on-air phone calls for mx dedications; pop songs; very enjoyable program!; 9/30. (Howard-CA)
- 4975.96 **UGANDA UBC Kampala** 1927-1941 Afropops; W ancment w/ ID & talk in lang; heard using SSB; fast QSB & QRN static; fair; 9/16. (Serra-Italy)
- 4985 **BRAZIL R. Brasil Central** Goiania 0214-0218 M w/ PP mx & talk; strong static; heard using SSB; poor; 9/10. (Serra-Italy) 0225-0231 M anc w/ PP talk; mx break; heard in LSB w/ QSB static & rustle; both almost nulled w/ NIR12; poor; 9/27. (Serra-Italy) 0233-0308 M giving an address; talk b/w mx bits & (P) ID; slow song; M w/ prayer; more mx & talk; heard in LSB; QRN static & fast QSB; p-f w/ NIR12; 10/4. (Serra-Italy) 0150 (P); Prg in PP; presumed based on lang & listing; poor; 9/30. (Rohde-OH) 0730-0750 M anc in PP w/ Brazilian folk mx; fair; 10/7. (Oliva-NY)
- 4990 **CHINA Hunan PBS** 1211-1420 Relaying CNR-1 live coverage of the closing ceremony of the Beijing Paralympic Games; sig improving the whole time; 9/17. (Howard-CA)
- 4990.83 **PERU R. Manantial** Huancayo 0000-0015 On this evening; 10/14. (Wilknier-FL)

- 5005 **EQ. GUINEA R. Nacional** Bata 2250-2303\* Afropop mx; SS ancments; s/off w/ NA; weak-poor in noisy conditions; 9/25. (Alexander-PA) 0515-0600 Threshold sig at 0515 t/in improving to a weak lvl by 0540; SS talk; Afropop & instrumental mx; no sign of 6250 Malabo; 9/26. (Alexander-PA) 2310 (P); M w/ SS talk; poor; 9/30. (Ronda-OK)
- 5010 **INDIA AIR Thiruvananthapuram** 1229 I have a harder time here in C. NAM getting AIR than they do on either coast since it's closer to transpolar to OK; so all I can rpt is that there were weak sigs w/ talk 1229 & 1237; (too early for Madagascar) & also at 1246 on 4940; freqs matching AIR Thurvan` & Guwahati; several more common freqs matching China; Indo & PNG were also in: 5030, 4900, 4790, 4750, 3995, 3905, 3385, 3335 & 3325; maybe on a better equinoxial sunrise I will be able to pull something identifiable from India on 60m; 9/18. (Hauser-OK) 1229 (P); Excited talking which sounded like Australian accented EE; maybe cricket?; weak & fluttery right past 1230; at 1300 recheck still audible w/ mx; don't see how it could have been anything else at this hour; 10/12. (Hauser-OK) 1232 M ancryn extended talk; poor; 10/12. (Strawman-IA)
- 5010 **MADAGASCAR RTV Malagasy** Antananarivo 0327-0405 Mx to 0331 ID & nx by M anc in Malagasy lang.; return to mx at 0350 but beginning to fade; p-f; 9/26. (D'Angelo-PA) 0314 M anc in Malagasy w/ occ. short mx breaks; p-f; 10/4. (Ronda-OK)
- 5030 **BURKINA FASO R. Burkina** Ouagadougou 2011-2018 Lcl chant; M anc w/ talk; heard in SSB w/ NIR12; strong static; poor; 9/27. (Serra-Italy)
- 5030 **CHINA CNR-I** Beijing 1211 Live coverage of the closing ceremony of the Beijing Paralympic Games; good; 9/17. (Howard-CA) 1224 Fast-paced chatter b/w M & W; p-f on peaks; 10/3. (Strawman-IA)
- 5035 **BRAZIL R. Aparecida** Aparecida 0041 (P); W anc in PP w/ lively instrumentals; poor; 9/25. (Taylor-WI)
- 5050 **INDIA AIR Gauhati** 1248 Threshold Hindi-style instrumental & vcl mx; poor; 10/3. (Strawman-IA) [nice catch-ed.]
- 5075 **CHINA V. of Pujiang** Shanghai 1320-1351 Changed back to their winter freq.; ex-9705; last heard here around April; fair; noted the usual //4950-fair & 3280-weak; 10/5-6. (Howard-CA)
- 5110U **USA WBCQ** Monticello 0100 Observations of the US Vice Presidential debate; at the last minute; WBCQ announced it would b/cast the debate live on 5110U; audible here running 15 seconds behind C-SPAN; I wonder what WBCQ's source is?; kudos for being the only known private US SW stn performing this public svc, while there were none at all for the first Presidential debate; 10/3. (Hauser-OK)
- 5120.4v **PERU Ondas del Suroriente** Quillabamba 1040 "...en cinco. la voz momento de flores..."; 9/18. (Wilkner-FL)
- 5460.43 **PERU R. Bolivar** Cd. Bolivar 2345 M en español over thunderstorms; [cl wx?-ed.]; 9/22. (Wilkner-FL)
- 5470.8 **PERU R. San Nicholas** San Nicholas 0152 (P); Barely above noise lvl; too weak for prg details; tnx D. Jensen tip; 9/18. (Strawman-IA) 2340 M en español w/ echo chamber FX & into atenciones; 9/22. (Wilkner-FL)
- 5580.2 **BOLIVIA R. San Jose** San Jose de Chiquitos 2320-2335 F/in w/ mx; seems to be maintaining a regular sked; weak; 10/3. (Wilkner-FL)
- 5765U **GUAM AFN** Barrigada 1237 String of mini-features; this is a great svc as no other stn bothers to strip the commercials if any & aggregate them in a row & at exactly the same times day after day; "Loh-Down on Science" was running; about a device mimicking mosquito bites for drawing blood; see <http://lohdown.org> as produced by KPCC; I have also run across this dropped into various public radio prgms; at 1238:30; Pat Carrollton CBS feature "Raising Our Kids" what to do if a head gets bumped; Then privacy-is-important-in-the-armed-forces, so don't-eavesdrop-on-your-roommate PSA; 1241 "Golf Minute" which quickly lost my interest; 10/1. (Hauser-OK)
- 5830 **KUWAIT R. Farda** 2029-2038 Lcl pop song; W & M w/ IDs in Farsi; ancment & nx w/ ments. R. Farda; Iran; Iraq & Sudan; 2024 mx break & ancments; ID & unknown pgm; QRN static; heard in LSB to avoid het; fair w/ NIR12; 9/27. (Serra-Italy)
- 5860 **CHINA V. of Jinling** Nanjing 1315 A mix of CC & Western easy-listening tunes; including a Muzak version of The Sound of Silence & anc cmentry in CC; f-p; 9/28. (Schieflbein-MO) [Nice catch-ed.]
- 5875 **USA WHRI** Cypress Creek 0112 Now has a third Hmong prgm; which I ran across; exc. clear rcption; no fading or distortion & a good time to record some more exotic mx; this was singing accompanied by a hi-pitched & repetitive drone on a string instrument bowed back & forth; 0117 ancment in Hmong & more mx; ended at 0129; back to EE; per online sked this is Hmong North Radio; under the auspices of one Liaj Sou Vang; 10/5. (Hauser-OK)
- 5890 **N. MARIANA ISLANDS VOA** Tinian 1315 Like clockwork VOA's KK svc breaks for a song in EE at 1315 & 11740 if it is propagating; "O Danny Boy" by W a.k.a. London Derrière; so I can't keep calling it from the "American Songbook"; 9/16. (Hauser-OK)
- 5890 **USA VOA** Greenville 0100 DetroCuban Jamming Command attacking VOA Spanish; same on //6110; when VOA was talking about the embargo; but jamming continued at 0130 in non-Cuban VOA prg; "Club de Oyentes" which started w/ Mercedes intrvwg on phone Ricardo ---; a Colombian photographer; about Armenia, Quindío; 10/5. (Hauser-OK) 

# International Band Loggings

Wallace C. Treibel • 357 N.E. 149th Street • Seattle, WA 98155 • nwhikers@msn.com

- 5910 **COLOMBIA Marfil Estereo** in SP 0450, Latin vocals, talks, IDs, b/w sels, f-g (D'Angelo PA 10/7)
- 5915 **ZAMBIA ZNBC** Lusaka in Vernacular \*0244, Fish Eagle IS, s/on annmct, mx, p (Barbour NH 9/29)
- 5920 **RUSSIA Kamchatka Radio** via Petropavlovsk in RS \*0710-0800, local programming but pre-0710 and post 0800 had Radio Rossii programming, ID, interview, news, pips 0800, fair (Howard CA 10/8)
- 5940 **RUSSIA R Rossii** via Magadan in RS 1230, pianist plying counterpoint, drums & synthesizer, off-key singer in EG, rock tune w/lyrics from "High School Confidential", good, //5920 (Hauser OK 10/1)
- 5960 **CANADA R Japan** relay in JP \*0200, IS, pips, NHK ID, rpt on Wall Street, g (McGuire MD 9/13)
- 5965 **CUBA RHC** Havana in SP 0433, ID, mx break, regional & sports news, fair-poor reception due to splats and het from adjoining frequencies (Serra ITALY 9/19)
- 5975 **TURKEY V of Turkey** in EG 0308-0353\*, news, IDs, features, "Letterbox", s/off included multiple IDs in several languages, schedule, IS (D'Angelo PA 9/25)
- 6005 **ASCENSION ISLAND BBC** relay in EG 0636-0655, YL hosting Network Africa program, ID and features, Top News stories at 0646, fair (D'Angelo PA 9/26)
- 60194v **PERU R Victoria** Lima in SP 0712-0741, news w/remote reports, mx segments b/w items, frequent TC's after each news feature, canned echo ID, poor to fair (D'Angelo PA 9/18)
- 60449v **MEXICO XEXQ R Universidad** San Luis Potosi in SP 1216-1400, continuous classical music, string of annmcts, ID hosting more orchestral music, f/o by 1400, good at peak (Schieffelbein MO 10/9) some mornings station is just barely audible but heard quite good on 10/9 at 1302-1341 w/YL identifying music w/opus numbers, mx keys, S9+10 w/light QRM (Hauser OK 10/9) ED: listed at 250 watts
- 6040 **PRIDNESTROVIE Radio PMR** Kishinev in EG \*2300-2331, ID, news, end of EG program at 2314 w/postal & E-mail addresses, sked followed by YL w/ID and into FR, good (D'Angelo PA 9/15)
- 60699v **CANADA CFRX** Toronto relaying MW CFRB 2246, traffic report, promos for free gifts including a free gas card, into the John Moore talk program at 2250, fair (D'Angelo PA 9/19)
- 6070 **LIBERIA ELWA** Monrovia in EG 2240-2300\*, religious music, closing annmct, NA, weak and poor w/adjacent channel splatter and mixing briefly with CVC Int'l Chile s/on 2300 (Alexander PA 10/2)
- 6110 **ETHIOPIA R Fana** Addis Ababa in Amheric \*0255-0342, IS, ID, program of Horn of Africa music beginning at 0300, news 0330, into vocals at 0333, fair and in the clear (D'Angelo PA 9/17)
- 6130 **LAOS Lao National Radio** Vientiane in EG/Laotian 1415, news in Laotian, 3-4 minutes of no audio, finally into "Hello, I am Elizabeth Moore. Welcome to Functioning in Business", g (Howard CA 10/6)
- 6140 **CUBA RHC** Havana in EG 0534, Latin song, news re Hurricane Ike, //9550, fair (Serra ITALY 9/13)
- 6145 **CANADA China R Int'l** relay in EG \*2300, ID, news, mention of Thailand, good (McGuire MD 9/12)
- 6150 **ROMANIA RRI** Bucharest in EG 0303-0355\*, brief news, several features "Travelers' Guide", "Sky Lark", "Football Facts", and "Letterbox", IDs, request letters, S7 fair (Wood TN 10/10)
- 6155 **AUSTRIA ROI** Moosbrunn in EG/FR/GM 0610, weather report for the Alps, into FR 0611, and into GM 0615 talking about Pulcinella with some of his music, some splatter from RHC (Hauser OK 10/6)
- 6160 **CANADA CKZU** Vancouver 2259, news w/mentions of Vancouver and BC-related events, poor with peaks to fair, ID (Ronda OK 10/4) ED: listed output for station is only 500 watts. Good DX in OK
- 6160 **CANADA CKZN** St. Johns, NB in EG 2254, feature "As It Happens", local CBC Radio One ID and mention of MW outlet, promos, news, p-f (D'Angelo PA 10/7) ED: listed at only 300 watts.
- 6165 **CHINA CNR-6** Beijing in Hakka 1307-1401, ballads and traditional songs, f-p with VOA QRM from 1335-1400, //9170 fair (Howard CA 10/7)
- 6250 **EQUATORIAL GUINEA R Nacional** Malabo in SP 1955-2005\*, local hi-life music, talk, abrupt s/off, weak but readable (Alexander PA 9/28) in SP 0510-0527, YL vocal, long talk by OM w/several "buenas dias", IDs alternating w/music segments, fair (D'Angelo PA 10/7)
- 7110 **ETHIOPIA R Ethiopia** Addis Ababa in Amheric 0332-0401\*, news, ID, music bridge, Horn of Africa vocals from 0351 until another ID 0359, bells and carrier terminated, fair (D'Angelo PA 10/1)
- 7130 **MALAYSIA Sarawak FM** via RTM Kuching in Vernacular 1250-1315, pop music, pips 1300, RTM news, patriotic song, more pop music, fair until CNR-2 s/on at 1300 (Howard CA 10/11)
- 7185 **ROMANIA RRI** Bucharest in EG 2228, nice local folk music, Mailbag reading an entry in their "fascination of radio listening" contest, good (Hauser OK 10/9)
- 7240 **PORTUGAL RPI** Lisbon in PT 0656, music, annmcts, fanfare, pips, ID, news, g (D'Angelo PA 9/18)

- 7250 **ARMENIA V of Russia** relay via Yerevan in EG \*0100, IS, ID, news re Pres Putin and Georgia, oil pipeline and crop reduction, fair (Barbour NH 10/7) in EG 0118, talk re Russian Orthodox Church and its relations with the Church of Constantinople, fair (Wood TN 10/10)
- 7260 **THAILAND R Thailand** in Cambodian 1123-1129\*, talk until 1128, bells followed by another OM with ID in EG and sked for Cambodian program, bells repeater before s/off, fair (D'Angelo PA 9/23)
- 7305 **VATICAN CITY Vatican Radio** in EG \*0250, IS, ID, talk about a recent Mass by Pope Benedict XVI honoring Pope Pius XII, talk re the American Bible Society, S-7/fair (Wood TN 10/10)
- 7415 **USA WBCQ** Kennebunk, ME in EG 2320, The Goddess Irena Show featuring "songs "Dream a Little Dream" and "Amour", fair (Fraser ME 9/18)
- 7425 **ALBANIA R Tirana** in EG 0334, feature dealing with the Albanian Constitution presented by YL who sounded bored, good signal (Wood TN 10/10)
- 9330 **SYRIA R Damascus** in EG 2102-2125, ID "Damascus calling. Here now is the news", fair to good with deep fades and only fair modulation (D'Angelo PA 10/7)
- 9495 **IRAN VOIRI Voice of Justice** Kamalabad in EG \*0130, IS, ID, NA, fqy, sked, f (McGuire MD 9/17)
- 9550 **CUBA RHC** ID, sports news, "Weekly Review", fair, //6060, 6140 (Serra ITALY 9/13)
- 9580 **GABON Africa #1** Moyabi in FR 2000, jazz music featuring Stan Getz, Artie Shaw, John Coltrane, and Charlie Parker, 4 pips at 2200 off by 4 seconds vs. WWV, news (Barker PA 9/7)
- 9625 **CANADA CBCNQ** via Sackville in EG 2230 with CBC Radio 1, The World This Weekend, ID and feature "Laugh Out Loud", season's new comedy show, good in the clear (Hauser OK 10/11)
- 9635 **CHILE CVC Int'l** Santiago in SP 2100-2259\*, talks, relig mx, LA mx, IDs 2258 (Alexander PA 10/3)
- 9650 **CANADA KBS World Radio** relay via Sackville in EG 1240, Korean language lessons on the theme of bank transactions - needed printed material to follow it (Hauser OK 10/2)
- 9690 **INDIA AIR** Bangalore in EG 1348, YL w/tribute to Gandhi, pro-non-violence "dialogue is the only way to prevent terrorism", rap music, QRM but good modulation (Hauser OK 10/2)
- 9690 **NIGERIA V of Nigeria** Ikorodu in EG 0957, IDs, news w/canned audio (mostly unclear), IDs and into feature program, fair (Serra ITALY 9/16)
- 9700 **BULGARIA R Bulgaria** in EG 2345, "Radio Bulgaria Calling", feature on the American Red Cross and ham radio, very good (Fraser ME 9/12)
- 9705 **NIGER LV du Sahel** Niamey in FR 2125, rustic flute, ID, YL and OM talks, fair (Taylor WI 10/4)
- 9715 **PORTUGAL R Portugal** Lisbon in PT \*2255, ID, NA, fqy, sked, pips, ment Cuba (McGuire MD 9/26)
- 9760 **PHILIPPINES VOA** relay in EG 1354, YL with USG editorial criticizing Malaysia's Internal Security Act allowing jailing of any opposition, mixed with CRI on 9760, //9510 in the clear (Hauser OK 10/2)
- 9855 **KUWAIT R Kuwait** in AR 2008, 2 OM's in low-keyed discussion, several mentions of "Islamic" and "Taliban", S-9 signal (Wood TN 10/8)
- 11650 **CHINA China Radio Int'l** via Urumqi in GM, current events about CH provinces, website, CH language lesson (Paszkievicz WI 10/10)
- 11690 **ECUADOR HCJB** Quito in SP 1310, inspirational relig talk and music, poor, //11960 (Wood TN 10/4)
- 11705 **CANADA R Japan** relay in EG \*1400, IS, pips, econ news, mention No. Korea (McGuire MD 9/19)
- 11775 **ANGUILLA Caribbean Beacon Network** in EG 1322, Gospel music, contact info, promos, into taped talks by the late Dr. Scott, S-9 very good signal (Wood TN 10/4)
- 118847v **MALAYSIA V of Malaysia** Kajang in CH 1213-1230\*, pop music, news, ID, fair (Howard CA 10/11)
- 12030 **GERMANY VOA** relay via Lampertheim in Kurdish/EG 1950, 2 OM in discussion in Kurdish with mention of Ramadan, then into EG w/mention of USA address, OM w/song in AR, news items with Iraq, US, and Russia mentioned, VOA ID at 2000 s/off, good (Fraser ME 9/21)
- 13635 **AUSTRALIA CVC Int'l** relay via Darwin in EG 1330, Christian mx, many IDs, fair (Wood TN 10/4)
- 13650 **CUBA China Radio Int'l** relay via Havana in PT \*2300, IS, ID, mainly news, g (McGuire MD 9/16)
- 15050 **INDIA AIR** Delhi in Sinhala 1330, OM w/talks and playing music, ID, g (Leite MA 9/25)
- 15120 **NIGERIA V of Nigeria** Ikorodu in EG 1916-2003, econ news, "Business Weekly", mx break, fqys, feature "Time for Highlife" w/afropop songs, IDs, African news, g (Serra ITALY 9/13) 1835-1850 with OM in heavily African accented EG talking about Africa, Nigeria and tribal functions, ID, PSA's, and into indigenous music, S5 fair (Wood TN 10/3) in EG 1818, talk, children's chorus, ID, TC, news and sound bites, poor to fair (Barbour NH 10/6)
- 15120 **CUBA RHC** Havana in SP 1358, ID, IS, YL speaking w/crowd noises behind, news (Fraser ME 9/18)
- 15140 **OMAN Radio Sultanate of Oman** Thumrait in EG 1436-1500, news, US & Euro pop music, chimes and gongs at 1500, into talks in AR, weak and poor in noisy conditions (Alexander PA 10/4)
- 15160 **FRANCE RFI** via Issoudon in RS 1316, novelty chanson in FR, RS annct, hard rock in FR 1327 until abruptly off at 1330 w/o announcement at conclusion of RS service from 1300-1330 (Hauser OK 10/1)

- 15190 **EQUATORIAL GUINEA R Africa** via Bata in EG 2240, religious program, ID, E-mail address, also mail address at Accra, Ghana, good strong signal riding over WYFR underneath (Alexander PA 10/2) in EG 2125, "World of Life" feature w/YL preacher verging on screaming, WYFR s/on at 2159 and over rides R Africa (Hauser OK 10/11, Howard CA 10/11)
- 15235 **SOUTH AFRICA Channel Africa** via Meyerton in EG 1710-1735, financial news, ID, sports report, pop song, into African news, fqy quote, slight QSB but good with S9+15 (Serra ITALY 9/10)
- 15275 **THAILAND R Thailand** in EG \*0200-0230, chimes, ID "This is HSK9 Radio Thailand", national news w/extensive reporting on unrest in the country, Royal family news, into Thai language at 0230, beamed to West Coast of NA, good (Howard CA 10/8)
- 15345v **ARGENTINA RAE** General Pacheco in SP 2154, back on the air again - had been off since late Aug., pips, ID in multi-languages, news, Argentine tangos, live sports coverage of the FIFA 2010 World Cup qualification, fair signal (Howard CA 10/8) heard weakly with sports heterodyning Morocco on the same frequency at 2114 (Hauser OK 10/11)
- 15390 **SOUTH AFRICA Southern Sudan Interactive Radio** in EG \*1258-1330\*, ID, description of their mandate, lots of doorbell sounds, some music (Paszkievicz WI 10/10)
- 15450 **TURKEY V of Turkey** in EG 1233, news report on Russian airliner crash, good (Fraser ME 9/14)
- 15475 **GABON Africa #1 Moyabi** in FR 1658, ID, PSA, pips, news re Congo, good (Wood TN 10/10)
- 15495 **GERMANY Gospel for Asia** relay via Wertachtel in Vernacular 1408, address, switched to another Vernacular at 1415, mentioned Jesus and gave another address (Paszkievicz WI 10/5)
- 15570 **VATICAN STATE Vatican R** in SH \*1600, IS, ID, African service, relig pgm, g (McGuire MD 9/25)
- 15650 **SLOVAKIA Miraya101 FM** via Rimavska Sobota in AR/EG \*1458-1510, crash start w/AR vocal mx, into EG news about Sudan at 1501, soundbites, p-f (Barbour NH 10/7) in EG/AR 1500, news about Sudan, IDs, website, into AR talk 1511, AR pop mx, fair (Alexander PA 10/4)
- 17605 **NETHERLANDS ANTILLES R Nederland** relay via Bonaire in DT 2200, pips, ID, "Newline" and economic news, good (McGuire MD 9/16)
- 17725 **LIBYA V of Africa** Sabrata in SH 1322, talk b/w AR music bits, IDs, poor to fair (Barbour NH 9/29)
- 21470 **ASCENSION ISLAND BBC** relay in EG 1326-1347, "The Ticket Show" on a CH film about Bruce Lee, promos on future items for The Ticket, strong S9+10 signal (Hauser OK 10/12)
- 21555 **RUSSIA Ginbot 7 Dinst Radio** relay via Samara in Amheric \*1700-1729\*, short breaks of local music, threshold signal-very weak but fair to good on //17655, Tues/Thur/Sat only (Alexander PA 10/4)
- 21695 **LIBYA V of Africa** Sabrata in EG 1530-1559\*, news, commentary at 1543 about the problems of democracy, IDs, strong signal, //17725 also strong (Alexander PA 10/4)

## Clandestine/Opposition Stations

- 6020 **JAPAN Shiokaze/Sea Breeze** via Yamata in EG \*1400-1430\*, "Today's News Flash on North Korean Issues" and "Today's Editorial", no FR segment, Friday is still the best bet to catch EG here but not a sure bet, some QRM from Vietnam by 1415, unable to hear any jamming tho (Howard CA 10/10)
- 9525 **ASCENSION ISLAND Cotton Tree News** relay broadcasting to Sierra Leone in EG \*0730, opening with drums and ID, news, poor signal (D'Angelo PA 10/1)
- 9895 **MADAGASCAR Radio Voice of the People** relay broadcasting to Zimbabwe in Vernacular 0406-0423 OM with news, IDs followed by talks w/mentions of Zimbabwe, p-f & mx jammer (D'Angelo 10/1)
- 9950nf **ARMENIA Open Radio for North Korea** relay via Yerevan in KR 2142-2200\*, radio drama with YL talking over piano music, contemporary KR vocal, announcement in EG "Open Radio for North Korea" and "Pomp and Circumstance", poor signal w/grinding noise jammer (Taylor WI 10/4) in KR 2147 with KR pop music and short segments of talk by OM and YL, "Pomp and Circumstance" at 2159, poor to fair reception (D'Angelo PA 10/7)
- 12035 **UNITED KINGDOM SW Radio Africa** relay via Rampisham in EG 1706-1804, due to power outage in London they had technical difficulties and presented a special lineup of programming, then went back to normal programming with Violet Gonda, good to fair with no jamming (Howard CA 9/29) ~~NA~~

Happy Thanksgiving

# Company Store

Jim Strader KB1KYW • 74 Miller St. • Middleborough, MA 02346-3216 • jimstrader@msn.com

The following items are available through the Company Store. Shipping is extra as noted.

## Publications

<b>Shortwave Listening Guidebook</b> by Harry Helms. A beginners guide to shortwave listening covering equipment and more.	\$19.95 +4.60 s/h US +8.00 s/h Can.
<b>Joe Carr's Receiving Antenna Handbook</b> A guide to high performance receiving antennas from longwave to HF and VHF.	\$19.95 +4.60 s/h US +8.00 s/h Can.
<b>Joe Carr's Loop Antenna Handbook</b> Comprehensive but readable guide to understanding and building loop antennas.	\$16.50 +4.60 s/h US +8.00 s/h Can.
<b>Radio Monitoring: the How-to Guide</b> by Skip Arey. Guide for new listeners to MW, HF, VHF and above.	17.95 +4.60 s/h US +8.00 s/h Can.
<b>Passport to Worldband Radio 2008</b> Great source of information about shortwave stations, frequencies in use and schedules.	\$18.90 +4.60 s/h US +8.00 s/h Can.
<b>World Radio and TV Handbook 2008</b> Long considered to be the bible for shortwave listeners.	\$26.90 +4.60 s/h US +8.00 s/h Can.
<b>Fine Tuning's Proceedings Reprint Catalogs</b> Complete list of articles from this hobby classic. Choose from 1) 5 page version with article titles or 2) 20 page version with article abstracts.	1) \$2.00 ppd 2) \$5.00 ppd
<b>The World QSL Book</b> Gail Van Horn's new CD-delivered book (PDF format) about all aspects of QSLing.	\$18.00 +3.00 s/h US +6.00 s/h Can.
<b>1947-1958 or 1959-1970 WRTH CD</b> CD compilation of the 1947 to 1958 or the 1959 to 1970 WRTHs.	\$60.00 ppd
<b>WRTH CD Set</b> Both WRTH CDs for a special price	\$99.00 ppd
<b>NASWA Country List and Awards Program Booklet</b>	\$3.00 PP US \$5.50 elsewhere
<b>NASWA T-Shirts</b> Return of a favorite in NASWA blue with the club logo.	\$14.00 S-XL 16.00 XXL +4.60 s/h US +8.00 s/h Can.
<b>NASWA Sweatshirts</b> Return of a favorite in NASWA blue with the club logo.	16.00 S-XL XXL s/h US s/h Can.
<b>NASWA Coffee Mugs</b> 11 oz. white mug with the club logo on two sides. Return of a favorite with the club logo in NASWA blue.	+4.60 s/h US s/h Can.
<b>NASWA Ball Caps</b> NASWA blue ball cap with velcro closure and NASWA logo embroidered on the front	+8.00 s/h US s/h Can.

Please make all checks payable in U.S. funds to "The NASWA Company Store".



North American Shortwave Association  
45 Wildflower Road  
Levittown, Pennsylvania, 19057

ISSN 0160-1989



The Journal of the  
North American Shortwave Association

**Executive Director:** Richard A.D'Angelo, 2216 Burley

Dr., Wyomissing, PA 19610

**Publisher / Business Manager:** Bill Oliver, 45 Wild-

flower Road, Levittown, PA 19057

**Executive Council:** Jerry Berg, Ralph Brandl, Dr Harold

Ester, Richard Guffrich, D'Angelo,

Alan Branson, Bill Oliver

**EDITORIAL STAFF**

**Managing Editor:** Dr Harold Cones, 2 Whitts Court,

Newport News, VA 23606

**Desktop Publishing/Graphics:** Ralph Brandl, PO Box

491, Lincroft, NJ 07738

**Easy Listening:** Richard Guff, 42 North 37th Street, Al-

lertown, PA 18104

**Shortwave Center:** John Figliozzi, 45 Algonquin Rd.,

Clifton Park, NY 12065

**Technical Topics:** Vacant

**Equipment Reviews:** Alan Johnson, N4LUS 2490 Sha-

delman Pkwy, Kutztown, PA 19530

**Adrian Peterson:** 1501 E. Adrian M. Peterson, Box

29235, Indianapolis, IN 46229

**NASWA Awards:** Gary R. Neal, 4866 N.Wynham Rd.,

Wichita, KS 67219-5501

**Listener's Notebook:** Al Quaglieri, PO Box 888, Al-

Bany, NY 12201-0888

**Private Radio Report:** Chris Lobdell, PO Box 146,

Stoneham, MA 02180-0146

**QSL Reports:** Sam Barro, 78 Blakeman Rd., Thomaston,

CT 06787

**Scoreboard:** Gary R. Neal, 4866 N. Wyncham Rd.,

Wichita, KS 67219-5501

**Kim's Column:** Dr. Kim Andrew Elliott, 5001 25th

Street North, Arlington, VA 22207

**Distributing Editor:** Rob Montgomery, P.O. Box 1458,

Levittown, PA 19058

**Topical Band Loggings:** Dan Ferguson, 4205 Friend-

ship Blvd., Levittown, PA 19058

**International Band Loggings:** Wallace C. Treibel, 357

N.E. 149th St., Shoreline, WA 98155

**English Schedules:** Mike Barracough & WDC,

39 Solleshort Hall, Letchworth Garden City, Hert-

fordshire SG6 3PW, United Kingdom

**The Company Store:** Jim Strater, KR1KYW, 74 Miller

Street, Middleborough, MA 02346-3216

**MEMBERSHIP FEES:**

United States (First Class Mail).....\$29.00

Canada (First Class Mail).....\$31.00

Overseas (Priority Mail).....\$38.00

Europe, North America and the Caribbean.....\$44.00

Japan.....\$48.00

Asia and Africa.....\$42.00

All remittances must be in U.S. funds and mailed to:

**NASWA**

**45 Wildflower Road**

**Levittown, PA 19057**

**U.S.A.**

**NASWA** : <http://www.naswa.net/>



FIRST CLASS MAIL

First Class Mail  
U.S. Postage  
PAID  
Levittown, PA  
Permit No. 319