

Quality Communications Equipment Since 1942

TEN-TEC
TEN-TEC

**RX-340 H.F.
D.S.P.
RECEIVER**



The TEN-TEC RX-340 communications receiver combines cutting-edge, state-of-the-art technology, with excellent ergonomics and esthetics. Digital signal processing (DSP) brings the performance and repeatability of expensive military grade communications receivers into the price range of top end commercial receivers for shortwave listeners. Tunable from 5 kHz to 30 MHz, it provides tuning steps and display resolution of 1 Hz. An astounding 57 bandwidths from 100 Hz to 16 kHz are included. All filters have a shape factor of 1.5:1 or better (6 to 60 dB). USB, LSB, ISB, CW, AM, Synchronous AM and FM modes are built-in. Four AGC modes are provided. A tunable Notch filter rejects unwanted signals in the passband. The receive front-end incorporates a built-in preselector with eight half octave bandpass filters. A switchable 10 dB preamp and 15 dB attenuator are also provided. The RX-340 also includes Built-In Test or "BITE". Memory and Scan functions fall into four categories: a scratchpad memory, 100 memory channels, memory scan and sweep (F1 to F2 scan). Separate volume controls are provided for the speaker and for the headphone. The front panel features a Lexan graphics overlay designed to last a lifetime. Made in Tennessee, U.S.A. Visit our website or request our 2000 catalog for full specifications. Under \$4000.

RX-320 PC RECEIVER



Universal also carries the top rated TEN-TEC RX320 PC receiver! Only \$294.95

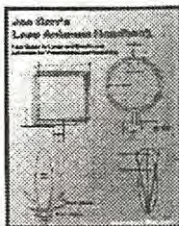

JOE CARR'S LOOP ANTENNA HANDBOOK **NEW**

By Joseph Carr. Here is your complete, 133 page guide to understanding and building high performance large and small loop antennas. Various easy to build designs are offered for models covering longwave, medium wave, shortwave and even VHF. Chapters include: Loop Theory and Construction, Loop Projects, Quad Loop Beams, Small Loop Theory and Projects, Loopstick Antennas, Radio Direction Finding, Small Loop Pre-amplifiers and Commercial Products.

Order #0016 \$19.95 (+*2)



JOE CARR'S RECEIVING ANTENNA HANDBOOK

By Joseph Carr. This guide to high performance antennas is written in Joe's clear, easy to understand, friendly style. Arguably the best book devoted to receiving antennas for longwave through shortwave. An excellent book for the shortwave listener who likes to experiment with different antennas. 189 pages.

Order #3113 \$19.95 (+*2)

Buy BOTH Joe Carr books and save big!

Order #4120 \$29.99 (+*4)

Shortwave Receivers

Past & Present 3rd Ed.

This huge 473 page guide covers over 770 receivers from 98 manufacturers, made from 1942-1997. Entry information includes: receiver type, date sold, photograph, size & weight, features, reviews, specifications, new & used values, variants, value rating & availability. 120 new pages. Become an instant receiver expert! #0003 \$24.95 (+*2)



● **Passport To World Band Radio 2000** New Edition Graphic presentation of all shortwave broadcast stations. Equipment reviews, too. 592 Pages! #1000 \$19.95 (+*2)

● **World Radio TV Handbook 2000** New Edition All shortwave broadcast stations organized by country with schedules, addresses, power, etc. #2000 \$24.95 (+*2)

● **Pirate Radio** By A. Yoder With audio CD! Here is the incredible saga of America's underground illegal broadcasters (with audio CD). 326 pgs. #3038 \$24.95 (+*2)

● **Worldwide Aeronautical Frequency Dir.** By R. Evans The definitive guide to commercial and military, HF and VHF-UHF aeronautical communications including ACARS. Second Ed. 260 Pgs. #0042 \$19.95 (+*2)

● **Discover DX'ing!** By J. Zondlo New Second Edition Hear distant AM, FM and TV stations. #0019 \$5.95 (+*2)

● **Shortwave Listening Guide** By H. Helms 2nd Edition Here is understandable information on: selecting and operating a shortwave receiver, simple antennas, time stations, pirates and much more. With informative tables and diagrams. 323 Pages. #2984 \$19.95 (+*2)

● **Understanding ACARS.** By E. Flynn Third Edition Learn the ACARS aeronautical format. #0012 \$9.95 (+*2)

● **Communications Receivers - The Vacuum Tube Era** By R.S. Moore Fourth Edition Key facts, figures and photos for shortwave receivers of the Golden Era 1932-1981. 141 pages. #2945 \$19.95 (+*2)

● **Communications Receivers - The Vacuum Tube Era** By R.S. Moore Fourth Edition Key facts, figures and photos for shortwave receivers of the Golden Era 1932-1981. 141 pages. #2945 \$19.95 (+*2)

● **Communications Receivers - The Vacuum Tube Era** By R.S. Moore Fourth Edition Key facts, figures and photos for shortwave receivers of the Golden Era 1932-1981. 141 pages. #2945 \$19.95 (+*2)

● **Communications Receivers - The Vacuum Tube Era** By R.S. Moore Fourth Edition Key facts, figures and photos for shortwave receivers of the Golden Era 1932-1981. 141 pages. #2945 \$19.95 (+*2)

● **Communications Receivers - The Vacuum Tube Era** By R.S. Moore Fourth Edition Key facts, figures and photos for shortwave receivers of the Golden Era 1932-1981. 141 pages. #2945 \$19.95 (+*2)

● **Communications Receivers - The Vacuum Tube Era** By R.S. Moore Fourth Edition Key facts, figures and photos for shortwave receivers of the Golden Era 1932-1981. 141 pages. #2945 \$19.95 (+*2)

● **Communications Receivers - The Vacuum Tube Era** By R.S. Moore Fourth Edition Key facts, figures and photos for shortwave receivers of the Golden Era 1932-1981. 141 pages. #2945 \$19.95 (+*2)

● **Communications Receivers - The Vacuum Tube Era** By R.S. Moore Fourth Edition Key facts, figures and photos for shortwave receivers of the Golden Era 1932-1981. 141 pages. #2945 \$19.95 (+*2)

● **Communications Receivers - The Vacuum Tube Era** By R.S. Moore Fourth Edition Key facts, figures and photos for shortwave receivers of the Golden Era 1932-1981. 141 pages. #2945 \$19.95 (+*2)

● **Communications Receivers - The Vacuum Tube Era** By R.S. Moore Fourth Edition Key facts, figures and photos for shortwave receivers of the Golden Era 1932-1981. 141 pages. #2945 \$19.95 (+*2)

● **Communications Receivers - The Vacuum Tube Era** By R.S. Moore Fourth Edition Key facts, figures and photos for shortwave receivers of the Golden Era 1932-1981. 141 pages. #2945 \$19.95 (+*2)

● **Communications Receivers - The Vacuum Tube Era** By R.S. Moore Fourth Edition Key facts, figures and photos for shortwave receivers of the Golden Era 1932-1981. 141 pages. #2945 \$19.95 (+*2)

● **Communications Receivers - The Vacuum Tube Era** By R.S. Moore Fourth Edition Key facts, figures and photos for shortwave receivers of the Golden Era 1932-1981. 141 pages. #2945 \$19.95 (+*2)

● **Communications Receivers - The Vacuum Tube Era** By R.S. Moore Fourth Edition Key facts, figures and photos for shortwave receivers of the Golden Era 1932-1981. 141 pages. #2945 \$19.95 (+*2)

● **Communications Receivers - The Vacuum Tube Era** By R.S. Moore Fourth Edition Key facts, figures and photos for shortwave receivers of the Golden Era 1932-1981. 141 pages. #2945 \$19.95 (+*2)

● **Communications Receivers - The Vacuum Tube Era** By R.S. Moore Fourth Edition Key facts, figures and photos for shortwave receivers of the Golden Era 1932-1981. 141 pages. #2945 \$19.95 (+*2)

www.DXing.com

- Glenn Hauser's Continent of Media
- Don Schimmel's Radio Intrigue
- Glenn Hauser's Shortwave DX Report
- Joe Carr's Tech Notes
- Favorite Tube Type SW Receivers
- Modern SW Receiver Survey

www.universal-radio.com

- Informative On-line Catalog
- Specials and Close Outs
- Used Equipment Listing
- Customer Cats & Staff Cats

Universal Radio, Inc.
6830 Americana Pkwy.
Reynoldsburg, Ohio
43068-4113 U.S.A.

800 431-3939 Orders & Prices
614 866-4267 Information
614 866-2339 FAX
dx@universal-radio.com
www.universal-radio.com

Visa, Mastercard or Discover card.
Prices and specifications subject to change.



UNIVERSAL 2000 CATALOG

Universal Radio's Catalog covers everything for the shortwave, amateur and scanner enthusiasts. With informative photos and full descriptions. To request your free copy please call toll-free:

1 800 431-3939

universal radio inc.

Quality Communications
Equipment Since 1942

Are you ready to attend the first ever NASWA **DXpedition**? Ever wonder what it would be like to spend a couple of days in a cabin doing nothing but radio? If you have never been on a **DXpedition**, November will be a golden opportunity. NASWA is sponsoring a **DXpedition** to French Creek State Park in southeastern Pennsylvania on November 10-12, 2000. What is it like to **DX** with **Fred Kohlbrenner**? Don't ask! See for yourself!! See this issue of the *Journal* for all the details. Hurry, space is limited to the first 15 members that send in their money. Act now!

From the Worldwide **DX** Club in Germany we learn that Turkey will be the host of the International Telecommunications Union ("ITU") **World Radiocommunication Conference 2000** ("WRC 2000") from May 8th through June 2nd. WRC 2000 is a forum where countries decide on the shared use of frequency spectrum to allow the deployment for growth of all types of radio communication services from television to radio broadcasting. One of the most important tasks of each WRC is to examine and decide on proposals for new or revised frequency allocations required for the introduction of new services or expansion of existing ones.

Bob Padula (404 Mont Albert Road, Surrey Hills, Victoria 3127, Australia. E-mail: bpadula@compuserve.com informs us that the latest *HF Spectrum Study #9* (B99) is available from the Electronic **DX** Press. This latest study summarizes aggregated monitoring results made in south and southeastern Australia, from November 3, 1999 to February 29, 2000, on frequencies between 2300-9999 kHz, in the time period 0000-0400 UTC, represented by some 150 entries. The study is compiled each summer for the Australian midday period, and shows fade-in and fade-out times, transmitter sites, transmitter countries, studio countries, and languages. A synopsis of propagation mechanisms is also given. The Study is an A4 monogram based on data provided by moni-

tors in Victoria and South Australia. A soft-copy version is offered free, and will be sent as an uncompressed Word 7.0 document, 120-kb. The Study will be of interest to anyone involved with international monitoring or frequency planning. A printed version is available for A\$5/US\$5 or 5 IRCs (sent via airmail outside of Australia).

Also from Bob is the brand new print publication, *Asia-Pacific Shortwave Guide*. The First Edition (May 2000) is for the international broadcast period concluding on October 28, 2000, and contains over 2,000 entries. Future issues will be dependent on demand shown for this new venture. It is produced not only to "fill the gap" due to the very costly annual "Year 2000" references being quite out-of-date for international broadcasts, but also as an inexpensive, timely, and accurate alternative. The 24 page A4, commercially printed Guide will be useful for all world radio monitors, irrespective of where they may be located. The price is to Australian addresses is A\$10; elsewhere (airmail) it costs A\$15 or US\$10 or 10 International Reply Coupons. Orders with payment should be forwarded to Bob Padula bpadula@compuserve.com, 404 Mont Albert Road, Surrey Hills, Victoria 3127, Australia.

The **Association for International Broadcasting** ("AIB") has just published its *Global Broadcasting Guide*, which lists all the English international radio programs and time & frequency information. The booklet contains contact information including postal address, telephone, FAX, and e-mail and Internet sites. The guide is available through the AIB (P. O. Box 4440, Walton CO14 8BX, England) for US\$11.35 for four issues or US\$5.75 for two issues. A single issue is available for US\$3.25. The AIB is a worldwide organization, which promotes and helps to develop international broadcasting. Among its membership are the following organizations: Adventist World Radio, Channel Africa, Radio Canada International, Radio Mi-

ami International, Radio New Zealand International, Radio Prague, Radio Sweden, Radio Taipei and Radio Vlaanderen International.

Don't forget to keep our new Manager of the Company Store, **Bill Bergadano** ka2emz@cybercomm.net busy. If you haven't purchased the club's Country List and Awards Program booklet now is a good time. If we don't keep him busy, Bill might actually leave his DX cave! The booklet is available from The Company Store (Bill Bergadano, P. O. Box 484, Colts Neck, NJ 07722) or head-

quarters. The price is US\$3.00 in North American and US\$5.00 worldwide.

Finally, the **14th annual Winter SWL Festival**, sponsored by NASWA, is scheduled for March 9 and 10, 2001 in beautiful Kulpsville, PA. Join other club members in a celebration of the radio-monitoring hobby. Festmeisters Cuff and Figliozzi and a "cast of thousands" look forward to seeing you next March in Kulpsville.

That's it for this month. Enjoy this month's edition of the Journal; it's another good one. 

Musings

This column provides a forum where members can express comments, ideas, and thoughts about NASWA or the SW radio hobby. Please feel free to comment on anything presented this month (or previous months). Opinions expressed here are solely those of the submitters. Please submit all Musings to Richard A. D'Angelo, 2216 Burkey Dr., Wyomissing, PA 19610 or via email: rdangelo3@aol.com.

Bill Smith (w5USM@aol.com), w5USM

I am wondering if it might be possible to renew publication of the NASWA Membership Directory as was done years ago? Two reasons, it would allow members to find other members in their vicinity; this might in turn stimulate some local activities like DXpeditions.

Given today's desktop processing and the membership mailing list, it would be rather easy to publish and cross-reference by state and ZIP code. The directory could be distributed through the company store at a price offsetting all cost plus contributing say an additional 40% to the NASWA coffers. I still have some of the 70s and 80s directories!

I'd sure like to reread some of those Charlie Loudenboomer tales, too.... those ole FRENDX were great.

73 from Bill Smith, w5USM "Shortwave Since 1950"

Arthur J. Brophy (AJBrophy123@aol.com), 387 McKinley Ave, Niagara Falls, NY 14305-1007

Each month, with the arrival of NASWA Journal, I tell myself I should write to the Musings column telling these people what a great job they are doing and how much the Journal adds to the enjoyment and understanding of the SWL hobby—please keep up the good work!!!!!! I have only been an active SWL'er for about five years and have just started my second year as a member of NASWA—reading the Journal cover to cover monthly.

Not being very tech savvy; I have a question that I hope some of the more knowledgeable and experienced members might like to comment on. Have been reading lately about using an antenna tuner with random wire antennas; I am wondering if it is of any great advantage to do so??? Comment either in the Journal or by e-mail me or by snail mail—Thank you!!!

Some random musings in closing—I truly enjoy the hobby, it entertains, informs and educates me each and every time I “tune in” and with no monthly fee—pretty amazing in today’s world. Sitting in front of a computer screen just is not the same as sitting in the glow of your receiver and tuning in the world—no comparison....

Continued good listening; Art

Walt Fair <wfair@iamnet.com>

I just made a quick trip back to Houston and was able to pick up the current WRTH and Passport books, along with 2 issues of the NASWA Journal that didn’t get forwarded to Venezuela yet. After living here in Maracaibo for a couple years, I’ve learned to truly appreciate the efficiency of US mail service and when the mail gets here, the *Journal* is one of things I really look forward to. To everyone involved: I really appreciate the efforts put forth by all.

I read Bob Padula’s article a few months back with interest. Although I don’t agree with everything he wrote, he raises some valid points and concerns. Although the future of international broadcasting may be questionable, my experience in third world countries, especially in Latin America, is that tropical broadcasting will be alive and well for some time to come, since it serves an important purpose for the local economies. Of course, everything is subject to economic considerations and tropical broadcasters will probably continue to decline as development takes place in many areas of the world, but in my opinion they will not all go away any time soon.

From my own travels and experience, many (not all) small stations in Latin America are basically mom-and-pop enterprises. The equipment that they use is far from state-of-the-art. Over and over again, I hear the plea for help in locating old transmitting tubes, etc. It seems to me that if we, as DX hobbyists, want the hobby to continue, then we ought to help ensure that the broadcasters stay on the air. Too often we tend to “expect” them to stay on the air. The reality of the situation is that the stations operate as businesses and if they don’t generate a profit, they go off the air. Period. There’s not much that we can do to increase their revenues, which mainly comes from advertising, messages, or grants. Nor can we do much about their expenses (electricity, salaries, etc.) Those things depend mainly on local conditions and the station management. But the other part of the bottom line is equipment. Quite a few small broadcasters go off the air due to equipment problems and unavailability of replacement parts. The profit margin is so thin that when equipment needs repair, the expense and wait just isn’t worth the return on investment.

If there were some way for a group of hobbyists, such as those in NASWA and other clubs around the world, to more actively support the small broadcasters, we would benefit from the relationship and they would be extremely appreciative. I am not a manager or even a very good organizer, but if there were a way to set up a group of volunteers to help obtain transmitting tubes and other necessary equipment for tropical band stations, it would go a long way in preserving our hobby. I wouldn’t propose giving equipment away, but perhaps helping to locate and ship equipment and voluntarily defray some of the expenses. In return, special DX broadcasts could be arranged, commemorative QSLs, etc. (This is still a half-baked idea, so any other ideas would be welcomed! There are also probably some “gotchas” I haven’t considered.) That should inevitably lead to more DX targets and easier QSLing, but more importantly to a better awareness of the hobby and communication between them and us.

So, that’s my crazy idea for the day. If anyone has any ideas on how to accomplish something along those lines, I’d appreciate hearing about it.

Walt Fair

Calendar Of Events

- May'00 Annual General Meeting.** The **Danish Shortwave Club International** will hold its AGM and DX Camp at Vejers Beach, Western Jutland, Denmark from May 12-14, 2000. Contact Bent Nielsen (Egekrogen 14, DK-3500 Vaerloese, Denmark) for further details.
- May 19 Meeting. Philadelphia Area NASWA Chapter.** Kulpsville Holiday Inn, Kulpsville, PA at 7:30 PM. For more information contact Dan Cashin at 610-446-7831.
- May 19 Meeting. Boston Area NASWA Chapter.** The Lexington Club, Rts. 4 & 225, Lexington, MA at 7:30 PM. The location is 1/4 mile west of Rt. 128, Exit 31. For more information contact Paul Graveline at 978-470-1971 or Internet: 74007.3434@compuserve.com. The URL for the BADX guys is <<http://www.anarc.org/naswa/badx/>>.
- Jun 9 Meeting.** The **Tidewater SWL's** meet at 6:30 PM. For more information plus meeting location contact Joe Buch at joseph.buch@dol.net
- Jun 9 Meeting. The Cincinnati/Dayton Monitoring Exchange (MONIX)** meet at the Lebanon Citizens National Bank on U.S. Route 42 in Mason at 7:00 PM. For more information contact Mark Meece at 513-743-8089 or e-mail at <mmeece@siscom.net>. For additional information about MONIX, check out their web site at <<http://www.siscom.net/~mmeece/monix.html>>
- Aug'00 DX Meeting.** The **6th National Mexican DX Meeting** will be held in Oaxaca, Mexico from August 4-6, 2000. For details contact the organizers at Miraizos@gnp.com.mx.
- Aug'00 Convention. The International Radio Club of America ("IRCA")** will its annual convention at the Homestead Quality Inn in Billings, MT from August 25-27, 2000. The \$35.00 registration fee made out to "John C. Johnson" can be sent to John and Nancy Johnson, 265 Waterton Way, Billings, MT 59102-7755. Check out the convention web site at: <http://pages.prodigy.net/john_johnson/irca2000>.
- Sep'00 Contest. AWR Contest.** Number of different QSL stamps in the listener's collection. More details to follow.
- Oct'00 Conference.** The annual **EDXC Conference** will be held in Barcelona, Spain from October 12-15, 2000 (temporary date until further notice). Details to follow.
- Mar 9-10 Convention.** The **14th Annual Winter SWL Festival**, sponsored by NASWA, will be held in Kulpsville, Pennsylvania (Exit 31 on the Northeast Extension of the Pennsylvania Turnpike). Richard Cuff and John Figliozzi co-chair the organizational committee. It's never too early to begin planning. See you there!
- Mar '01 Contest. 2001 North American DX Championships.** For further information you can send a self-addressed stamped envelope to 2001 NADXC, c/o Dr. Harold Cones, 2 Whits Court, Newport News, VA 23606. Rules will also be posted eventually at <<http://www.anarc.org/>>, and are published in the Awards column in the Journal.

Members are invited to submit items to be included in this calendar to Rich D'Angelo (Internet: rdangelo3@aol.com) or Ralph Brandi (Internet: ralph@brandi.org).

Contribute!

Send your loggings and QSL information off to our Distributing Editor, **Fred Kohlbrenner** (2641 South Shields Street, Philadelphia, PA 19142). He will forward them to the appropriate editor. Remember, Fred has now expanded his business to include QSL report information and totals for the **Scoreboard** column. He can also be reached through the Internet at: fkohl@ix.netcom.com.

Special DXpedition Information

During our many, many years of DXpeditions to Gifford Pinchot and French Creek State Parks, there have been numerous hobbyists that have expressed an interest in attending one of these extravaganzas. Since we are limited to how many people can actually attend these events by the size of the cabins, it is impossible to accommodate everyone.

At our last French Creek DXpedition, the regulars (Fred Kohlbrenner, Ed Mauger, Bob Montgomery and Rich D'Angelo) kicked around the notion of a "NASWA DXpedition." Subsequently, Executive Council has given the "French Creek Regulars", now known as the DXpedition organizing committee, the green light. We are targeting early November, which coincides with our usual first outing of the DX season and should be reasonably safe weather wise. The cabins must be paid for shortly after we make reservations, therefore, we must require payments to be made up front to hold your spot. It is the hope of the Executive Council and the organizing committee that by holding a club sponsored DXpedition members that would not normally have an opportunity to go on a DXpedition would have a chance to participate in an organized club sponsored event.

Here are the details:

- § The DXpedition organizing committee consists of Fred Kohlbrenner, Ed Mauger, Bob Montgomery and Rich D'Angelo.
- § The DXpedition site will be French Creek State Park, Elverson in southeastern Pennsylvania. French Creek offers a modern cabin rental, which means they are heated, have indoor plumbing and a complete kitchen. Participants are responsible for their own food and beverage arrangements. The park has been very accommodating with antennas. No alcohol!
- § The DXpedition coordinator will be Fred Kohlbrenner (2641 Shields Street, Philadelphia, PA 19142). The cost will be \$60.00 per person. All reservations and payments will be made through Fred.
- § The DXpedition is open to NASWA members only. Non-members can participate by joining the club. The number of spaces will be limited to 15, which represents three full cabins of DXers. First come, first served - that means money talks!
- § The DXpedition will run from Friday through Sunday, November 10-12, 2000. Check in time is 3:00 PM on Friday. Departure time is 9:00 AM on Sunday.
- § Members who are interested in attending must notify Fred Kohlbrenner on or before May 31, 2000. Payment must be received at the time of notification. Refunds can only be made if a replacement DXer can be found. If space is available we may accept latecomers but there can be no guarantees. The organizing committee will make any decisions. If not enough payments are received, this club-sponsored event will be cancelled and all money returned.
- § Tentative plans include a group picture, a group pasta dinner on Friday evening with a meeting to exchange information, DX conditions, targets, etc. Subsequent group gatherings are planned for Saturday afternoon and a closing meeting on Sunday just prior to departure. Don't forget to bring a camera, oh, and a shortwave radio!



Easy Listening

Richard D. Cuff • 327 Springhouse Road, Apt. 102 • Allentown, PA 18104 • rdcuff@sprintmail.com

BBC World Service: Wonder What's Behind the Curtain?

The **BBC World Service** has launched their new 8-stream revised shortwave schedule, and it has been an occasionally bumpy ride. Early on, there were numerous examples of misdirected streams; for several evenings, North American listeners were even treated to the New Zealand stream – which isn't even supposed to be available on shortwave to New Zealand. Even now, nearly four weeks into the schedule, the "weaving" within the various streams can be unpredictable. The beginning and ending of program segments is cut off, or a promotional announcement is aired that doesn't match the actual program schedule.

This reminds me of the scene in the *Wizard of Oz* where Toto pulls back the curtain in the "throne room", and the Wizard bellows, "Pay no attention to what you see behind the curtain!" There are probably mad scrambles going on at Bush House and at the Merlin Communications sites trying to pull off an obviously complicated orchestration of streams, programs, and continuity content.

Clearly the World Service has a different look & feel following the launch. A news bulletin now appears on the half hour before any feature scheduled for that time slot, and a brief look at headlines appears 45 minutes into the hour. Quite often, you'll hear the program identified as "BBC News" without the phrase "World Service" in the middle. The flagship news programs, such as *Newshour* and *The World Today* have been outfitted with new music themes, and the overall sound seems a bit less frantic than before.

As for the various feature programs, I haven't detected any other significant changes in approach. At least, now, East

Coast prime time evening listening is not saddled with full-hour or half-hour long news programming; the evenings are devoted more to feature programming. This was a very visibly stated goal of the schedule shuffling—news programs were deemed to be most important in the morning hours and in late afternoons, with features aired evenings. It looks like the World Service is delivering on that goal.

Somewhat annoyingly, the printed versions of schedules available in *On Air* magazine or via download of a PDF file emphasize each region's key local times and days, with a conversion to UTC appearing much less prominently. This can be annoying when listening to streams targeted elsewhere—such as the West Africa and European streams. Thankfully, the text and Excel spreadsheet versions of the schedules, available at the BBC's website, are still in good old UTC.

Speaking of the BBC's website, the World Service will have launched a revamped set of Internet web pages by the time you read this; the current plans are to launch the new pages on May 3rd. One enhancement will be a greater variety of on-demand content. This enhancement, coupled with batch recording software like Voquette (<http://www.voquette.com>), enables one to create custom downloads of programming in the sequence you prefer.

Here's what you can look forward to in BBC World Service programming for May from the BBC's website and *On Air* Magazine:

Features

Tuesdays, 1530, beginning May 2nd, and Saturdays, 0130, beginning May 6th: As the USA blazes a trail in high technology, communications and global reach, *Manifest Destinies*, part of the *Essential Guide* series, asks what issues are shaping the America of tomorrow. In this series of

three landmark 30-minute documentaries, the BBC's former Washington correspondent Bridget Kendall travels from Wisconsin and Arizona to Los Angeles and Las Vegas, talking to immigrants and city mayors, millionaires and welfare mothers, to find out where they think their country is heading.

Mondays, 2345, and Wednesdays, 0330: *Patterns of Faith* is a series of 15-minute programs on the importance of religion in society. In May, the series will feature *Playing with Spirit*, a look at spirituality in the theatre, *Wesak*, a celebration of the annual *Theravadin* Buddhist Festival, and *Food for Thought* which explores the role food plays in global cultures and beliefs.

Popular Music

Mondays, 1430, and Tuesdays, 0030: In the new eight-part series of *Blues World*, part of the *Music Mix* series, Tony Russell looks back at the blues heritage and also plays the best of the very newest blues, reflecting its influence throughout the world. Getting the weekly 30-minute show on the road are discs from 16-year-old Sean Costello, followed by 74-year-old BB King, and ending with 13-year-old French musician Nawfel.

Science and Technology

Tuesdays, 1530, beginning May 23rd, and Saturdays, 0130, beginning May 27th, Science and technology have always been linked to warfare—from gunpowder, to poison gas, to nuclear weapons. But in this century, they will move closer to the front line of battle. *Essential Guide* continues with *Laboratory of War*, a new three-part 30-minute series, investigating how scientists are both creating and combating new challenges to international security.

Drama and the Arts

Mondays, 1405, Tuesdays, 0005, and Wednesdays, 0505: Michael Goldfarb hosts a series of 25-minute discussions and interviews regarding the arts in the USA in

America In Perspective, in the *Meridian – Ideas* series. America in the 21st century is more creative and, at the same time, more unified and more disparate than it has ever been. In this series, leading writers, artists and cultural thinkers reflect on how the arts help shape, define and explain American society.

Saturdays, 2200, and Mondays, 0530: *Play of the Week* highlights include:

May 6/8: *An Immaculate Misconception*, the first play by Professor Carl Djerassi, the American scientist internationally renowned for having 'invented' the contraceptive pill in 1951. The play is about parenthood, and the creation of new life in the absence of sexual intercourse. Djerassi wants to provoke discussion about the ethics of cutting edge reproductive technology and inform people what genetic manipulation could mean for the future of us all.

May 13/15: *Fisher of Men*, by David Constantine, is a play written partly in verse telling the story of the wreck of the Royal Charter on the rocks of Anglesey in 1859 and the devastating effect it has on the isolated community of Moelfre and its vicar.

May 20/22: *Design for Murder*, by Marcy Kahan: Noel Coward would have been 100 in December 1999 and, thanks to BBC Radio Drama, he enters his second century in one of the few careers he never achieved in life. Marcy Kahan invents a Noel Coward who turns his restless imagination to crime—putting himself at risk by investigating the murder of an actress.

Weekdays, 1305 and 2305: The World Service is marking *BBC Music Live 2000*, the biggest live music festival in the UK, with special programs for its listeners around the globe. On Memorial Day, Monday, May 29, a special edition of *Outlook* comes live from the streets of Leicester. The city's music festival brings together the best of world music from bhangra to New Orleans jazz, from ska to reggae.

Radio Australia: A Mirror and a Window

This past month, I sampled the **Radio Australia**-presented, **National Radio**-produced programs *The Comfort Zone*, *The Law Report*, and *Health Report*. Each program, while produced primarily for a domestic audience, led off a story or development from the USA, and then compared that trend with trends in Australia and elsewhere in the Pacific region. In that sense, **Radio Australia** was functioning as a mirror on American affairs, while then providing a window into Australian viewpoints on these issues. This method was very effective in comparing cultural biases between the two regions, not something you'll find very often in domestic American radio of any sort. Of these three, my personal favorite was *The Comfort Zone*, which debates and celebrates the cultural significance of architecture and design, gardening and food. These aren't topics you'll hear covered very often in by any broadcaster, including the BBC. The only Radio Australia airing of *The Comfort Zone* is 1605 Tuesdays, useful for shortwave listening in the Western USA, but not feasible for shortwave here in the Northeast. The show is webcast live, but is not available for on-demand listening. I set my computer up to connect automatically to Radio Australia's URL to record the program on tape as it airs, as the 1605 air time is not very conducive to live listening.

I don't mean to sell either *The Law Report* or *Health Report* short; these programs generally feature three stories recently in the public eye, but cover more conventional topics than *The Comfort Zone*. *Law Report* airs 0030, 1030, and 1530 Tuesdays; *Health Report* airs 0030, 1030, 1530, and 2130 Mondays.

Also in the "don't miss" department, a special documentary series on development in the Pacific islands, *Carving Out*, is in the middle of a 13-week run ending in early June. The series has a fine website (<http://www.abc.net.au/ra/carvingout/default.htm>) with an audio archive of

all prior programs, along with other information germane to the topic of Pacific development. **Radio Australia** air times include Saturdays 0530 and 1830, and Sundays 0030 and 2130. The program emphasizes a single topic in each edition, allowing for extended debate and analysis.

Radio Netherlands

As has been widely reported elsewhere, the diesel electricity generators at **Radio Netherlands'** Bonaire transmitter site were severely damaged by fire on Easter weekend; some transmissions have been moved to alternate sites, but other transmissions had not yet been accommodated as of press time. Check Radio Netherlands' website, at the specific URL of <http://www.rnw.nl/realradio/html/schedule.html>, for updated information.

Meanwhile, from Radio Netherlands' website, here are the upcoming documentaries you can look forward to. All documentaries air Thursdays, 0000, and Saturdays, 0030:

May 11/13: *Pulling the Plug on Pox*—Smallpox was once the scourge of mankind—until an aggressive vaccination campaign all but wiped it off the face of the earth; the last known case of smallpox was in 1979. However the smallpox itself still exists in 2 places in the world—both scientific establishments. So now the question is "Should these last remaining stocks of the deadly virus be destroyed so that smallpox will never again be a threat? Or should they be kept for further scientific study that might help in the battle against other viruses such as HIV for instance?"

May 18/20: *Forgotten Wars #4—Impunity*: Long after the brutal civil conflict that took place in Matabeleland in western Zimbabwe in the 1980's, discussion of what happened is rarely made public. Yet many believe in Zimbabwe, as in all brutal wars, only an open admission of what happened and an end to the impunity of the perpetrators can unite the country and help heal those who suffered.

May 25/27: *Viva Flamenco!*—Flamenco is one of the most distinctive, dramatic musical forms of Europe. In its homeland, Andalusia, Flamenco is far more than folk art; it is a discipline, a philosophy, and a way of life. Jane Murphy travels to southern Spain, to explore the history and emotions that define the various forms of gypsy music and dance.

Program Review: *Religion and Society*

Peter Bowen posted the following program review at the *swprograms* E-mail list:

"This show is typical of DW's feature programs: competent and solid reporting, but decidedly bland presentation.

"*Religion and Society* is a 15-minute program broadcast once each week, usually on Sunday in the target area. Each edition is presented by a single host, Gabriele Fritz. Her job seems to be to introduce the one report that makes up almost the entire duration of the program, and then to offer some closing comments. Some DW hosts speak well, but most sound quite flat. Ms. Fritz unfortunately falls into the latter category.

"In keeping with the focus of all programming on DW, most of the stories come from European countries. Each show has only one report, and it is a packaged report (a 'package') offered by a single reporter. These reports are very good, offering lots of comment from the reporter, as well as interviews and ambient sounds.

"Although the title leads one to believe that this is a program about religious topics, that is in fact not always the case. Rather, each program deals with the connection between a religious topic and the wider society.

"The starting point for the package is indeed a religious topic, but the reporter then expands the discussion to speak about the much wider societal effects and implications. There is a varying balance

between discussion of the religious topic per se, and its impact on the wider society. Thus, the result is a report on a topic that often has only the barest relation to the original religious item.

"In spite of the fact that the reports featured in *Religion and Society* are of high quality, this is nevertheless a disappointing program. There is often very little content dealing with religion and religious topics. And although the show is well-produced, Ms. Fritz is less than impressive as the host. Perhaps her main contribution is what she does 'behind the scenes'."

Internet Sources for Programming Information

Even if your budget only allows access to electronic mail, there are several sources of program information you might want to note for future reference. The list of stations is gradually getting larger as they discover this efficient means of disseminating program information.

Radio Sweden sends out a weekday E-mail message on the day's programming; subscribe by sending a blank message to radiosweden-subscribe@topica.com.

Deutsche Welle sends out a daily E-mail including a program preview and a German press review. You can subscribe by E-mailing majordomo@dwelle.de and including the text *subscribe english-programme* in the body of the message.

HCBJ has sent out twice-weekly E-mail previews, the *Andean Herald*, for the longest of any international broadcaster; an e-mail to english@hcbj.org.ec (not an automated address) will get you on the list.

Radio for Peace International sends out weekly advance information and other station news; to subscribe, you'll need to visit the webpage <http://www.boinklabs.com/mailman/listinfo/rfpi-announce> and fill out the form.

Until next month, 73 DE Richard



Listener's Library

T. J. "Skip" Arey N2EI • P. O. Box 236 • Beverly, NJ 08010 • tjarey@home.com

Every now and again I like to trot out a book with a bit more of a technical view. I don't just do this to see if anybody notices. Rather, I know more than a few folks like to stretch their minds and learn a bit more about what goes on inside these receivers we all play with.

Ladder Crystal Filters
by John Pivnichny N2DCH
134 pages
No Price Listed
ISBN # 1-891237-20-9
MFJ Publishing
Starkville, MS 39759

For the last few years we have been talking a great deal about receivers moving in the direction of digital signal processing. Well, unless your willing to spend fairly large sums of money on your equipment, DSP is still out of reach. The fact is, most of the "heavy lifting" in terms of signal management is done in the radio world by way of crystal filtering. The "Ladder" type crystal filter is very popular, especially among people who build and experiment with transmitter and receiver circuit design because fairly high performance filters can be built using inexpensive, surplus computer industry crystals.

John Pivnichny is an Extra Class Amateur, and Graduate Electrical Engineer. The author has collected most of the scholarly work done in this area of filter design and he has included references to every paper included on the subject to date. The book covers crystal and capacitor characteristics with reference to the ladder filter model as well as measurement of crystal parameters and their suitability for use in this design. Chapters are devoted to the more common crystal filter uses such as sideband filters, tunable filters, CW filters and lattice filters. There is also a chapter covering computer programs for us in filter design. Several

scripts of BASIC programs are included. The book is designed for the serious student of the subject but many of the designs within it can be easily adapted into circuits by hardcore homebrewers.

I always enjoy the opportunity to review a book written by a fellow member of NASWA. I enjoy even more reviewing a book written by a close friend. Our own Rich Arland has come up with a new book on his favorite subject (and one of mine as well) low power amateur radio.

Low Power Communication: The Art and Science of QRP
by Rich Arland K7SZ
204 Pages
\$14.95
ISBN # 0-87259-733-4
The American Radio Relay League
225 Main Street
Newington, CT 06111-1494
1-888-277-5289

Many of you may remember my previous reviews of Rich's three volume *Low Power Communications* series published by Tiare Publications. Literally from the moment those books went of print, many people, myself included, started chasing after Rich for a new book that would serve the radio hobby community as well as his previous books did. Well little did we know that Rich was about to really take this project on in style. Publication of his new ARRL book on the subject of QRP more or less coincided with the announcement that Rich was to become the monthly contributing editor to QST magazine on the subject of Low Power radio. All this coming off serving for a number of years on the staff of *Monitoring Times* magazine.

Unless you have been participating in the radio hobby from the depths of a cave somewhere, you are more than likely aware

of the resurgence in interest in QRP amateur radio operation. A number of factors have led to this peak in interest. Not the least of which has been Rich's many books and articles on the subject. QRP or transmitting with power levels less than 5 watts allows for a return to the two basics of the ham radio hobby, Operating and Construction. QRP gear is inexpensive to own and operate, home built equipment can be assembled for next to nothing. And nothing I have ever found beats the excitement of working a station with less power than a Christmas Tree lightbulb!

Rich's latest book is a "one Stop" guide to all the essential aspects of this exciting and growing area of Amateur Radio. Rich begins with the history of low power operation that leads into a description of all the excitement that QRP can be. Once you finish reading these chapters it will be hard to hold back so Rich goes on to give the beginner all the information needed to get up and running at 5 watts or less. His study of available QRP kits and commercial gear is exhaustive, even including some of the latest gear out there such as the Elecraft K2. If anybody thinks radio kits died with Heathkit leaving the industry, Rich's book will show you that home building is alive and well. You will also learn that it can be very easy and really inexpensive. Once you're on the air as a bonified QRP'er, Rich goes on to give great tutorials on the advanced skills that will turn you into a master of the QRP art. These chapters include information on propagation and operating techniques that can give your teeny signal just what it needs to get through. The book goes on to describe yet another aspect of the QRP world that I am convinced is the main reason for the rapid growth of this segment of the radio hobby. The QRP fraternity as it is lived out on the air, on the Internet and through clubs. Rich talks about how getting involved in the QRP world can be a great way to become part of a group of people dedicated to helping each other grow in their understanding of the radio art.

So I guess you can say I really want you to read Rich's book. Then I'll meet you down on 7040 kHz.

While we're on the subject of Low Power operation, let me slip in one more QRP book. But don't turn the page just yet... This book offers information of use to non-QRP radio hobbyists as well.

QRP Projects From Down Under

by Drew Diamond VK3XU

132 pages

No Price Listed

ISBN # 1-891237-22-5

MFJ Publishing

Starkville, MS 39759

Drew Diamond is an Amateur Radio operator in Australia who is dedicated to homebuilding radio equipment, specifically for low power operation. However, while Drew limits his output power, his ideas about how to go about constructing electronic equipment has universal application. Drew's book is a compilation of a number of receiver, transmitter and support circuit designs that can easily be used to either directly build equipment or can be used as a stepping off point for your own ideas. In amongst the circuit information is a wealth of wisdom about home brewing. Drew is a proponent of "Paddyboard" construction. This construction technique has been written about in the U.S. radio hobby press under the names "Ugly Construction" or "Manhattan Style Soldering". The general technique is to assemble components on printed circuit board without etching the board as is traditionally done. This technique can be used for fast "breadboarding" of experimental circuits but I have found a life as a full blown construction technique, particularly with low power homebrewers. Drew's description of how to build with this technique is about as good as any I've seen and I've written a few articles on the subject myself! I've had a lot of fun using the ideas out of this book and I have yet to actually build any of the circuits in it. It is that rich with ideas. 

Shortwave Center

Jerry Lineback • 506 South Lawrence Avenue • Scranton, KS 66537 • jlinebk@satelephone.com

Tropical Band Radio in the Center of South America

Guayaramerín, Bolivia and Guajará-mirim, Brazil

Walt Fair, Jr., KE5WJ

In developed countries, like the United States, radio seems to be mainly a form of entertainment. Indeed most Americans don't even think about shortwave radio, much less listen to it. Instead, shortwave radio seems reserved mostly for hobbyists. In less developed countries, however, shortwave radio is still a much more important part of daily life, filling a need for communication and education, as well as entertainment. This became very apparent on a recent trip to the center of South America, where I had the opportunity to visit several dedicated shortwave broadcasters who fill exactly such a need.

In July 1999, my wife suggested that we visit Beni, in the northern part of Bolivia, where she grew up. She had told me stories of fighting with monkeys who stole her bananas, swimming with piranhas, lawlessness, etc., but to a gringo, these stories were hard to accept at face value. She assured me that we had to go and see firsthand, to which I readily agreed. The trip began in Santa Cruz, Bolivia, where we spent several days visiting friends and family. Santa Cruz is a dynamic city of over 1 million people; a bustling, busy city; the center of Bolivia's oil industry. However, the outer $\frac{2}{3}$ of the city has no paved streets. From Santa Cruz we traveled over night by bus to Trinidad, then took a smaller bus from Trinidad to Guayaramerín in the department of Beni.

I was assured that the trip was easy now that a "carretera" (highway) has been built across Beni. In fact the "highway" had not yet been paved, but was mostly a narrow dirt road. It

took 2- $\frac{1}{2}$ days to get from Trinidad to Guayaramerín, a distance of about 200 miles. The 3 drivers alternated shifts, continuously chewing their coca leaves. We saw a total of 4 or 5 trucks along the way, so the traffic was never a consideration! Along the way we had to get out of the bus and walk across several muddy areas due to the fear that the bus might turn over. We also made 4 river crossings on wooden barges, either hand pulled or guided by a small motor boat. Along the way the countryside was full of hawks, eagles, parrots, giant ant mounds, and alligators, with the landscape varying from open fields to swamps to dense jungle. At one stop, a woman who went to wash up at a pool of water on the edge of the road, quickly ran back to the bus when a not too friendly alligator came up to see who was there. At a police inspection point, a young quechua woman was arrested for transporting drugs and we were all searched. I'm sure she did not have a very nice day! For me, it was an interesting adventure. For the people who live there, it is a way of life.

Guayaramerín is a bustling city of about 20,000 in the north of Departamento Beni, Bolivia on the banks of the Mamoré River, which forms the border with Brazil. About $\frac{1}{2}$ of the roads are paved inside the city. There is a small airport with daily flights to Riberalta, Cobija, La Paz and Trinidad, but there is no daily newspaper or internet. There are few automobile taxis, but the primary means of transportation, as in most of rural Bolivia, is the motorcycle. A large taxi consists of 2 seats attached to a motorcycle and the largest store is the motorcycle dealership. The city is a center for trade with Brazil and thrives mainly by supplying the

farms and ranches in the area. Guayaramerín is also home to 3 tropical band shortwave broadcasters, which provide an important service to the surrounding area.

A 5 minute launch ride across the Mamoré River lies Guajará-mirim in the state of Rondonia, Brazil. Guajará-mirim is also a city of about 20,000, but has a much better infrastructure, with paved streets and a daily newspaper. Although there is a train and a partly paved highway, the city is very isolated from the rest of Brazil. Unfortunately, the Brazilian economic crisis has had an effect on the area. Guajará-mirim was nearly dead in comparison with the bustle of activity on the Bolivian side of the border. Guajará-mirim also has a tropical band shortwave broadcaster that provides an important service to the surrounding area.

Radio Mamoré

Radio Mamoré, CP147, is located in a small single story building in Guayaramerín a few blocks from the Mamoré River. When my wife and I visited the station, the staff was so surprised to have a foreign visitor that they announced it over the air, then put on some music and dropped everything to talk with us and show us around.

According to the owner, Sr. Lucio Montan Escobar, it is the oldest shortwave broadcaster in the area, on the air since 1967 and officially licensed in 1971. It broadcasts daily from 6:00 am to 1:00 pm and 5:00 pm to 10:00 pm local time (1000-1700 and 2100-0200 UTC) on 4815 kHz. The antenna is a drooping folded dipole, with the center about 20 ft above the ground. Due to the proximity to the airport, a larger or higher antenna cannot be used. Their broadcasts are also carried locally on 95.1 MHz FM. All programs are in Spanish.

Nominally, Radio Mamoré uses 500 watts, but the transmitter is always run at lower power to conserve the transmitting tubes.

The transmitter, which was totally rebuilt by a Brazilian technician, is in a back room of the station building. The back of the transmitter is open and a fan is blowing on the equipment to keep it cool, since there is no air conditioning. When I listened to the station on my portable receiver, I noticed a rapid frequency variation. When I saw the transmitter, I realized that it is due to the coils in the transmitter wobbling in the breeze of the fan. It produces a very unique effect!

Sr. Montan also explained that the station has been off the air several times due to personal obligations and due to a lack of transmitting tubes. When he travels to take care of business obligations, his wife and 1 person staff do their best to maintain operations, but with little income, the situation is often difficult. He especially asked me to help him find a ready source of 813 transmitting tubes.

The announcer, Sra. Teresa Araujo, explained that they are quite proud of their programming especially for women in the area. She feels that they provide an important service in disseminating information on nutrition, health and family issues. In addition, messages are routinely broadcast for people in the area along with the distinctive tropical Bolivian music. Sra. Araujo also mentioned that it is very difficult for them to get information on producing and running a radio station.

Interestingly, Radio Mamoré is not mentioned in the 1999 editions of either WRTH or Passport to World Band Radio. The station has received several reports from Europe over the years, but none from the US. Sr. Montan assured me that he will verify reception reports and is very interested in hearing from foreign listeners. The station address is Radio Mamoré, Direc. Beni y Mamoré, Guayaramerín, Beni, Bolivia. With the low power and low antenna, this would make a fine catch for the upcoming DX season.

Radio Paititi

Radio Paititi, CP 185, is located in a small two story building opening into a market place near the center of Guayaramerín. The staff was very surprised to have a foreign visitor and also made a special point of announcing our visit on the air. They very cordially showed us around and answered my questions.

The staff informed us that Radio Paititi broadcasts daily with 500 watts on 4682.4 kHz from 6:00 am to 10:00 pm (1000-0200 UTC). It recently celebrated 29 years of tropical band broadcasting and 6 years on 100.1 MHz FM. The antenna is a folded dipole at about 40 feet. Most of the daily broadcasts consist of Bolivian tropical music. All programming is in Spanish.

The name of the station reflects its tropical Bolivian heritage. According to legend, when the Spanish conquered the Incas in Bolivia and Peru, a group of Incas fled from the mountains into the jungle in the Beni area and established a city of gold. The Spanish name for the city is El Dorado, but the Inca name is Paititi. The city has never been found and there is debate among archeologists on whether it actually existed or not. At any rate, both Paititi and Radio Paititi are uniquely a part of this area of Bolivia.

According to the owner, Sr. Carlos Arteaga Tacana, Radio Paititi's transmissions cover all of Beni and serve as an important communications link for the area. In fact the station was started primarily as a message service, with other programming as a sideline. While we were there several people dropped off messages to family and friends for broadcast over the air. Such messages range from "Happy Birthday" to "I made it to town and will come home tomorrow." The station charges a modest fee (Bs 2 or about \$0.40) for broadcasting the messages.

According to the staff, they have received quite a few reception reports from Europe over the years, but only a few from the US. The station indicated that they will verify reports. The address is Radio Paititi, Casilla No. 167, Guayaramerín, Beni, Bolivia.

Radio Galaxia

In addition, Sr. Arteaga showed me the transmitter for Radio Galaxia, CP218, located in the same building as Radio Paititi. Although Radio Galaxia is listed in both WRTH and Passport, it has not actually been on the air recently. Final arrangements were in progress and Sr. Arteaga expected to begin broadcasting with 500 watts on 5160 kHz within about 2 weeks. By the time this article reaches press, it should be active. The station slogan is "La Joven Sintonia" (The Young Sound) and will target a younger audience with tropical music. If you hear it, send a report to the same address as Radio Paititi.

(In addition, the 1999 edition of WRTH shows Radio Hitachi as also broadcasting from Guayaramerín. While visiting, no trace of the station was heard and inquiries led nowhere. Although the taxi drivers knew exactly where Radio Mamoré and Paititi were, they were not familiar with Radio Hitachi.)

Radio Educadora

Radio Educadora's studios are located in a single story building facing a square on the Brazilian side of the Mamoré River in Guajarámirim. When we visited the station, the staff was surprised to see foreign visitors with an interest in the station and cordially received us. (I had logged the station several years earlier, which really surprises them.) They proudly showed us the studios, record library, and the original station equipment, which is no longer in use. We were also invited to witness the first test television broadcasts from the station.

Radio Educadora broadcasts with 5 kw on 3375 kHz from 9:30 am to 12:00 noon and 8:30 pm to 10:00 pm local time (1330-1600 and 0030-0200 UTC). The transmitter is located about 5 km outside of town. The station also broadcasts on FM and now also relays television broadcasts received by satellite. All broadcasts are in Portuguese.

The station is part of the Radio Educadora system, which is supported by Fundacao Dom Rey, a part of the Catholic Church. The

station director, Father Isidoro José Moro, explained that they are dedicated to educating the natives who live in the surrounding region. For that reason, the station logo shows a native in the jungle speaking into a microphone. Programming consists of educational and religious programs with a fair amount of tropical music. The station is quite proud of its music library, which is the largest in the entire area.

*I was assured that
the trip was easy
now that a "carretera"
(highway) has been built
across Beni. In fact
the "highway"
had not yet been paved,
but was mostly a
narrow dirt road.*

*It took 2-1/2 days to get from
Trinidad to Guayaramerín,
a distance of about 200 miles.*

Although the station has much better equipment than the stations on the Bolivian side of the border, it still faces challenges. As the staff explained, their main problem in starting up the TV broadcasts is keeping condensed moisture out of the antenna and transmission system. In addition, they proudly showed pictures of the staff working to install guy wire anchors, raise the TV antenna tower and satellite dish, all done manually by volunteers over the previous weekend.

The staff said that they will verify reception reports, which should be sent to Radio Educadora, Praca Mário Correa 90 - Centro, CEP 78957-000, Guajará-mirim, Rondonia, Brazil. They indicated that they had received reports from all over the world, including some from the US. This station should be a moderately difficult catch, but not impossible. Best time to listen in the US is probably in the evening before sign-off.

Conclusion

While in Guayaramerín, we also had a chance to visit relatives and see some of the surrounding area, including rapids on the Rio Beni and an old rubber plantation no longer in active use. It was an interesting experience and my wife and I will be forever grateful for the opportunity to have met the people who run the stations there. To return to Santa Cruz, we opted to forego the bus ride. Instead, we took a 1-1/2 hour flight via TAM (Transportes Areas Militares or Military Air Transport) with a stop in Trinidad. We have already decided that on the next trip we will go see other parts of Departamento Beni and we will probably go by bus, but return by air.

While visiting the stations, I took pictures with my digital camera, which immensely intrigued everyone. After our visit to the stations, I printed out and mailed copies of the photos, along with some information on Houston (where I run my business) and Maracaibo (where we live). I subsequently received correspondence from all 3 of the stations, thanking me for the visit and photos. Radio Paititi also sent a commemorative 30th anniversary pennant and a QSL for hearing them while in their studio. Radio Educadora requested a second set of the photos, signed and suitable for framing to display in the office. All of the stations invited us to come back for another visit, which we will gladly do if we have a chance.

In conclusion, it is apparent that the tropical band stations in both Guayaramerín and Guajará-mirim provide an important service for their local areas. Besides entertainment, the educational and communication aspects of their broadcasts are important for the area. In addition, it is difficult not to be impressed with the hard work and dedication of the station owners and staff. Considering the efforts required to keep a station on the air in the face of equipment and economic problems, a more dedicated and sincere group of broadcasters would be hard to find anywhere in the world. 

Technical Topics

Joe Buch N2JB • P.O. Box 1552 • Ocean View, DE 19970-1552 • joseph.buch@dol.net

Long-wire Antenna Optimization

The end-fed long-wire antenna is probably the simplest and most often used outside antenna for short-wave radio listening. If installed correctly the antenna can be very effective.

Most homebrew antennas of this type and even commercial derivatives like the Alpha Delta slopers are not designed for maximum performance. This month we will learn about a better way to install your sloper or long-wire antenna to maximize performance. I will also introduce you to a relatively new company on the SW scene that understands the problems and has the devices you need to implement an improved installation.

Remember the success of any short-wave antenna depends upon how well it picks up desired signals while minimizing local noise sources. The electric fields generated by the power wiring in your house can couple noise generated by appliances, computers, fluorescent lights, and light dimmers. Such sources of electrical noise normally limit the sensitivity of your short-wave receiving system. It is important to minimize coupling between your receive antenna, the wiring in your house, and your power ground system.

The simplest designs use a single unshielded downlead to couple the antenna to the receiver. The wire inevitably passes within a few feet of the power, telephone, and cable TV wiring in the walls of your house. With the advent of broadband Digital Subscriber Line (DSL) signals on your telephone wiring as you and your neighbors get fast Internet access, the unshielded phone wires will soon become a major interference source. Early adopters of cable TV modems for Internet access have reported such severe interference that cable companies have been required to replace the modems with better designs. The simple unshielded feed wire will soon be obsolete.

One way around this problem is to use a shielded coaxial cable lead-in with a transformer at the junction between the lead-in and the horizontal wire. Various so-called "Magnetic Long-wire Baluns" (MLBs) are sold to match the coaxial cable lead-in to the wire.

Unfortunately many of these devices do not properly isolate the shield of the coax from the antenna. The shield ends up acting as part of the antenna, picking up noise from the house wiring.

A long-wire antenna installation of this type is depicted in Figure 1.

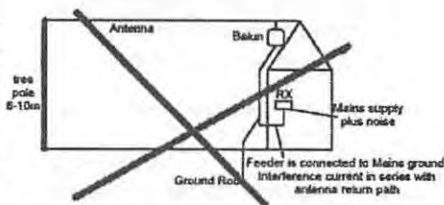

Figure 1. A typical long-wire antenna installation is susceptible to pickup of noise generated in your house wiring.

The horizontal part of the antenna comes very close to the house. In the most popular designs, the antenna side of the transformer is connected to the coax cable shield. The shield then works with the horizontal wire as the other half of a bent dipole. This configuration offers little improvement over the unshielded lead-in wire when it comes to rejecting local noise.

The connection, at the point where the feedline joins the antenna, is depicted schematically in Figure 2. The left winding conducts RF current from the antenna to the coax cable shield which then routes the current to ground. The oscillating magnetic field set up by this current induces a voltage

in the secondary winding and the coaxial cable.

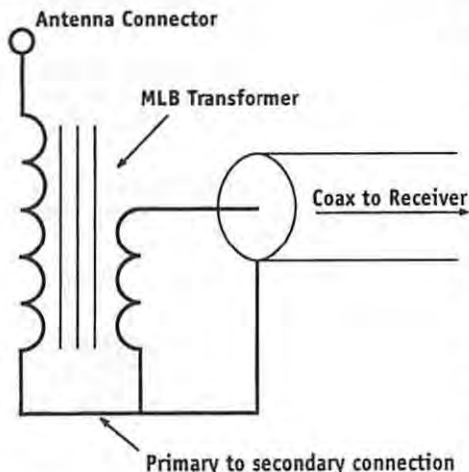

Figure 2. A conventional MLB has a connection that forces the shield of the coax to act as a part of the antenna. More noise pickup is the result.

A relatively new company in the SWL industry has designed a line of products that address this problem. The company is Wellbrook Communications. You can look over their entire catalog at <http://wellbrook.uk.com/>. This is a UK company and at present they have no North American sales representative. If you do not have Internet access, you can write them at Wellbrook House, Brookside Road, Bransgore, Christchurch, BH23 8NA, UK.

The Wellbrook approach to low noise, long-wire antenna design is shown in Figure 3.

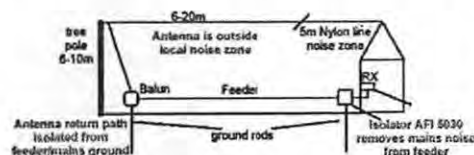

Figure 3. This long-wire antenna design keeps all active parts of the antenna away from noise sources and shunts noise on the house grounding system to earth.

The closest part of the antenna is about 17 feet (5 meters) from the house. The vertical part of the antenna is as much as 75 feet (25 meters) from the noise sources in the house. This down-lead wire is what picks up most of the noise on conventionally designed antennas. At the far end of the antenna a transformer isolates the coaxial feed line from the antenna. The bottom of the transformer primary is connected only to its own isolated ground stake in contrast to conventional approaches that connect the bottom of the primary to the coax shield. A low loss ground field consisting of many curved radial wires could be used for maximum efficiency but this would be overkill for receive applications. The coax connects only to the transformer secondary.

The schematic of this transformer looks the same as Figure 2 with the exception that the jumper between the primary and secondary windings is removed and the bottom of the primary is connected to the ground stake. Burying the coax further helps to minimize any pickup on the shield. The coax shield is connected to the house ground but here an isolator is used to make sure that noise components on the ground system are shunted to earth rather than traveling out the shield to the vicinity of the antenna. I have successfully used RG-6 cable because it is designed for direct burial and is readily available because it is used for satellite TV installations.

Thanks to the folks at Wellbrook for allowing me to use their material for Figures 1 and 3. I have no connection with Wellbrook and have not actually tried their products. I do use a similar antenna design with an isolator from The Radio Works in Portsmouth, VA and can vouch for the soundness of the Wellbrook design. I can no longer hear my computer or TV sets on the short-wave bands. If you have local interference, try it. You just may be pleasantly surprised. Until next time, stay tuned.

SW

Listener's Notebook

Al Quaglieri • P.O. Box 888 • Albany, NY 12201-0888 • FAX: (518) 453-0864 • al@alcue.com

NOTE #1: Due to a recent fire at the Bonaire relay station, international broadcasters using that facility may be silent on Bonaire frequencies or have shifted them to other sites. By time this column hits print, the station may have effected repairs and again be operational. In any case, Bonaire relays listed below may or may not be there when you check.

NOTE #2: There is a lot more summer schedule info at hand than I could fit into this month's column. Therefore, for this month ONLY, I will email the additional info to members who contact me at LN@alcue.com. Sorry, I cannot print or distribute hard copy on this additional data.

COPYRIGHT NOTICE Items credited to BBCM are copyright by the BBC Monitoring Service and may not be reproduced without BBCM permission.

AFGHANISTAN Schedule for <i>Radio Voice of Shari'ah</i> :			0700-0800	English	9660 12080 15240 15415 17580 17750 21725
0100-0330	Pashto/Dari	7084v	0800-0830	English	5995 9710 12080 13605 15240 21725
0330-0800	Pashto/Dari	7084v Fr	0800-0830	Indonesian	15415 17750
1230-1500	Pashto/Dari	7084v	0830-0900	English	5995 9710 12080 13605 15240 15415 17750 21725
1500-1530	Urdu	7084v	0900-1000	Indonesian	11550
1530-1545	English	7084v	0900-1100	English	11880 13605 17750 21820
1545-1600	Arabic	7084v	0900-1100	Tok Pisin	5995 6020 9710 12080
1600-1615	Turkmen	7084v	1100-1200	English	5995 6020 9580 13605 21820
1615-1650	Uzbek	7084v	1100-1230	Chinese	9475 11880
1650-1700	Russian	7084v	1200-1330	English	5995 6020 9580 11650 21820

(BBCM + Shcherbakov-KAZ/DXLD/Hauser-OK)

ARGENTINA RAE, Radiodifusion Argentina al Exterior:

0000-0200	Portuguese	11710 Mo-Fr	1230-1330	Vietnamese	9475 11880
0000-0300	Spanish	6060 Sa/Su	1330-1400	English	5995 6020 9475 9580 11650 21820
0200-0300	English	11710 Mo-Fr	1400-1700	English	5995 9475 9580 11650
0300-0400	French	11710 Mo-Fr	1700-1800	English	5995 9475 9580 9815 11880
0800-1200	Spanish	6060 15345 Mo-Fr	1800-2000	English	6080 7240 9475 9580 9815 11880
1000-1200	Japanese	11710 Mo-Fr	2000-2100	English	9500 9580 9815 11880 12080
1200-1400	Spanish	11710 Mo-Fr	2000-2100	Tok Pisin	6080 7240 Su-Th
1800-1900	English	15345 Mo-Fr	2100-2130	English	7240 9500 9580 9660 11880 12080 17715 21740
1800-2400	Spanish	6060 Sa/Su	2130-0000	Indonesian	11695 15415
1900-2000	Italian	11710 15345 Mo-Fr	2130-2200	English	7240 9660 11880 12080 17715 21740
2000-2100	French	11710 15345 Mo-Fr	2200-2300	Chinese	15240
2100-2200	German	15345 Mo-Fr	2200-2300	English	17715 17795 21740
2200-2300	Spanish	9690 15345 Mo-Fr	2300-2400	Indonesian	11550
2300-2400	Spanish	9690 15345 Mo-Fr	2300-2400	Khmer	15240

(Apr 9/Slaen-ARG/EDXP/Padula-AUS)

AUSTRALIA Radio Australia for A-00:

0000-0100	English	9660 12080 15240 17750 17580 17795 21740	2300-2400	English	9660 12080 17715 17795 21740
0000-0100	Vietnamese	15415			
0100-0500	English	9660 12080 15240 15415 17750 17580 17795 21725			
0500-0600	Khmer	15415 17750			
0500-0600	English	9660 12080 15240 15515 17580 21725			
0600-0700	English	9660 12080 15240 15415 15515 17580 17750 21725			

Radio Australia's weekend sports program, Grandstand, is broadcast on English frequencies from 0200-0800 UT Saturday and 0300-0800 UT Sunday on 9660 12080 17580 and 21725. (Padula-AUS/Bueschel-GER)

BELGIUM *Radio Vlaanderen Internationaal* has changed 17735 to 17590 for English to Africa via Ju-lich at 1730-1800 (Brems-BEL/rec.radio.shortwave/Norfolk/DXLD/Hauser-OK)

BELARUS *Radiostantsiya Belarus / Radio Belarus International / Radio Minsk*

0100-0130 Belarusian 7210 11670
 0130-0200 Belarusian 7210 11670 Mo-Sa
 0130-0200 Russian 7210 11670 Su
 0200-0230 German 7210 11670 Th
 0200-0230 Belarusian 7210 11670 Tu
 0200-0230 English 7210 11670 Su/Mo/We/Fr/Sa
 0230-0300 Russian 7210 11670 Mo
 0230-0300 Belarusian 7210 11670 Tu-Sa
 0230-0300 German 7210 11670 Su
 1900-1930 Belarusian 7210 11960
 1930-2000 Belarusian 7210 11960 Mo
 1930-2000 English 7210 11960 Tu-Th
 1930-2000 Russian 7210 11960 Fr
 1930-2000 German 7210 11960 We/Sa/Su
 2000-2030 Russian 7210 11960 Mo/Tu/We/Th/Sa
 2000-2030 Belarusian 7210 11960 Fr/Su
 2030-2100 English 7210 11960 Tu/Th
 2030-2100 German 7210 11960 We/Sa/Su
 2030-2100 Russian 7210 11960 Fr
 2030-2100 Belarusian 7210 11960 Mo

(BBCM)

BOLIVIA New: 4716.8 *Radio Yura*, Yura, Provincia Quijarro, Departamento de Potosi, 1150, "Esta es Radio Yura, La Voz del Layo, recordando siempre que estamos trabajando en onda corta, 4715 de frecuencia en onda corta desde Yura, provincia de Quijarro, departamento de Potosi" "...estamos a escasos 5 minutos de las 9 de la mañana y pues hasta esta hora hemos acompañado desde Radio Yura, La Voz del Layo, ahora s les decimos que sea hasta horas de la tarde, a partir de las 6 de la tarde estaremos volviendo a vuestra sintonia, amigos oyentes les deseamos que pasen un buen da y que Dios mediante..." (Fontenelle-BOL/Hard Core DX)

BRAZIL 2379.92 *Radio Educadora*, Limeira, Sao Paulo, 0020 Apr 13, possibly the one with play-by-play football commentary and nice signal; music and DJ chatter after 0200, but no ID until I gave up around 0230. (Apr 13/Novello-NC)

BULGARIA *Radio Bulgaria*

0000-0100 Bulgarian 9400 9500 11600 11700
 0100-0200 Spanish 9500 9700 11600
 0100-0200 French 9400 11700
 0200-0300 Russian 5900 7500
 0200-0300 English 9400 11700
 0300-0400 Bulgarian 5900 7500
 0400-0430 Greek 7300
 0430-0500 Albanian 7300 Mo-Fr

0430-0500 Greek 7300 Sa/Su
 0430-0500 Turkish 6000 7400 Mo-Fr
 0500-0545 German 9400 12000
 0500-0600 Turkish 6000 7400 Sa/Su
 0500-0600 Serbian 7300 Mo-Fr
 0600-0700 French 12000 13600
 0600-0700 Albanian 7300 Sa/Su
 0700-0800 Serbian 7300 Sa/Su
 1000-1100 German 15700 17500
 1100-1200 English 15700 17500
 1200-1500 Bulgarian 7300 13600
 1400-1500 Russian 9900 11700 13800
 1500-1545 Serbian 7300
 1500-1600 Bulgarian 9900 11700 13600 17500
 1545-1630 Albanian 7300
 1600-1700 Spanish 15700 17500
 1600-1800 Bulgarian 9900 11700
 1615-1700 German 9400 11800
 1630-1715 Greek 7300
 1700-1800 French 9400 11800
 1715-1800 Turkish 7400
 1800-1845 German 9400 11800
 1800-1900 Russian 9900 11700
 1800-1900 Bulgarian 6000 7400 7500
 1900-1945 Albanian 6000
 1900-2000 English 7535 9400 11700
 1900-2100 Bulgarian 7400 7500
 1945-2030 Greek 6000
 2000-2100 French 9400 11700
 2030-2115 Serbian 6000
 2100-2200 English 9400 11700
 2115-2215 Spanish 11800 13800
 2300-0000 Russian 11900
 2300-0000 Spanish 9500 11600
 2300-0000 English 9400 11700

(BBCM +Ivanov-BUL/Bueschel-GER)

CHINA Official A00 schedule for *CRI* English services:

0100-0200 9570*
 0300-0400 9690
 0300-0400 9690
 0400-0500 9730 9560
 0400-0500 9730
 0900-1100 15210 11730
 1200-1300 11675 15415 9760
 1200-1400 9715 11980
 1300-1400 9570* 7405
 1300-1400 11675 11900
 1400-1500 11825* 15110*
 1400-1600 13685 15125
 1400-1600 7405
 1500-1600 7160 9785
 1600-1700 9565 9870
 1600-1700 7190 9565
 1700-1800 9670*
 1700-1800 9570 13700 11910 9695* 9670*
 1900-2000 9440 9595*
 2000-2100 9440
 2000-2130 11735 13640

2000-2200 15110 11790

2200-2300 9880

2300-0000 5990*

Freqs shown as * are advised by the station as "testing." (Padula-AUS/EDXP)

CYPRUS Cyprus Broadcasting Corporation (CyBC)

2215-2245 Greek 6180 7205 9760 Fr-Su

(BBCM)

CZECH REPUBLIC Radio Prague, A00 Summer Period 2000:

0000-0030 English 11615 13580

0030-0100 Spanish 11615 13580

0100-0130 English 7345 11615

0130-0200 Czech 7345 11615

0200-0230 Spanish 7345 7385 11615

0230-0300 Czech 7345 7385 11615

0300-0330 English 7345 7385 11615

0330-0400 English 11600 15470

0600-0630 French 5930 7345

0630-0700 German 5930 7345

0700-0730 English 9880 11600

0730-0800 Spanish 9880 11600

0800-0830 French 9880 11600

0830-0900 Czech 11600 21745

0900-0930 English 21745

0930-1000 Czech 21745

1000-1030 German 6055 9880

1030-1100 English 9880 11615

1100-1130 Czech 11615 21745

1130-1200 English 6055 21745

1200-1230 German 6055 7345

1230-1300 Czech 6055 7345

1300-1330 English 13580 17485

1330-1400 Czech 13580 17485

1400-1430 Spanish 11600 13580

1430-1500 French 11600 13580

1500-1530 German 5930

1530-1600 Czech 5930 21745

1600-1630 English 5930 21745

1630-1700 French 5930 21745

1700-1730 English 5930 21745

1730-1800 Czech 5930 21745

1800-1830 Spanish 5930 13580

1830-1900 French 5930 13580

1900-1930 Spanish 5930 13580

1930-2000 Czech 5930 11600

2000-2030 English 5930 11600

2030-2100 Spanish 5930 11600

2100-2130 Czech 11600 15545

2130-2200 English 11600 15545

2200-2230 French 11600 15545

2230-2300 English 11600 15545

2300-2330 Spanish 11615 17485

2330-2400 Czech 11615 17485

ECUADOR HCJB

0000-0300 Quechua 3220 6080

0000-0400 English 9745 15115 21455

0000-0500 Spanish 6050 15140

0030-0100 French 9635

0330-0430 Russian 11865

0400-0600 English 9745 15115 21455

0430-0500 Japanese 11960

0500-0515 Kikongo 15140

0500-0530 German 11875

0530 0600 Slovak 11875 Mo/Fr

0530-0600 Czech 11875

0600-0700 English 9745 15115 15160 21455

0630-0700 French 11875

0700-0730 Spanish 11875

0700-0800 English 11755 15160 21455

0800-0930 Portuguese 9745

0800-1100 English 11755 21455

0830-1000 Quechua 3220 6080 9765

0900-1100 Spanish 9780

0930-1000 German 11980

1000-1400 Quechua 3220 6080

1030-1100 Huarani 6050

1100-1300 Spanish 6050 11960 15140

1100-1530 English 12005 15115 21455

1130-1200 Japanese 15550 17795 21470

1300-1500 Spanish 6050 15140 17690

1500-1800 Portuguese 15295

1500-2130 Spanish 6050 15140

1530-1630 English 12005 15115

1600-1615 Bashkir 11760R Su

1600-1615 Tajik 11760R Tu/Th

1600-1615 Uzbek 11760R Mo/We

1600-1615 Tatar 11760R Fr/Sa

1615-1630 Georgian 11760R Su

1615-1715 Russian 11760R Mo-Sa

1630-1715 Russian 11760R Su

1715-1730 Ukrainian 11760R

1830 1900 Slovak 17795 21470 Mo/Fr

1830-1900 Czech 17795 21470

1900-1930 French 17795 21470

1900-2200 English 17660

1930-2000 German 17795 21470

2000-2030 French 17795 21470

2100-2130 German 17795 21470

2100-2130 Quechua 3220 6080

2100-2200 Arabic 12020R

2130-0000 Quechua 3220 6080 9745

2130-2230 Spanish 6050 15140 17795 21470

2200-2300 Japanese 11680

2230-2300 Spanish 6050 15140

2300-0230 Portuguese 11920

2300-2400 German 11980

2300-2400 Spanish 6050 15140 21455

R=via Rampisham, UK

(HCJB website)

(Mar 24/R. Prague/Schaay-HOL/Bueschel-GER)

INDIA All India Radio summer schedule:

0000-0045	Tamil	4790 9835 9910 11740 13795
0015-0100	Urdu	6155 9595
0100-0130	Burmese	9950 13630
0100-0200	Sindhi	5990 7125
0100-0430	Urdu	6155 9595 11620
0130-0200	Tibetan	9565 13700
0130-0230	Nepali	3945 6045 9810 11715
0215-0300	Pushtu	9910 11735 11895 13620
0300-0345	Dari	9910 11735 11895
0315-0415	Hindi	13695 15075 15180 17710
0400-0430	Persian	15780
0415-0430	Gujarati	17710
0430-0530	Hindi	15075 17710
0430-0530	Arabic	13620 15780
0700-0800	Nepali	7250 9595 11850
0830-1130	Urdu	9595 11620
0845-0945	Indonesian	15780 17485
1000-1100	G.O.S-II	11585 13700 15020 17485 17840 17895
1115-1200	Thai	15340 17895
1115-1215	Tamil	13700 15075 15770 17620 17860
1145-1315	Chinese	15780 17705
1215-1245	Telugu	13700 15770 17620
1215-1315	Burmese	11620 11710
1215-1330	Tibetan	9565 11695
1230-1500	Sindhi	6165 9620 11585
1300-1500	Sinhala	15020
1300-1500	Sinhala	9700 15020
1315-1415	Dari	7255 9910
1330-1430	Nepali	3945 4860 6045 11695
1330-1500	G.O.S-III	9710 11620 13710
1415-1530	Pushtu	7255 9910
1430-1930	Urdu	4860 6045
1500-1600	Baluchi	6165 9620 11585
1515-1600	Gujarati	11620 15175
1515-1615	Swahili	9950
1615-1715	Russian	15140
1615-1730	Persian	7230 9910 11585
1615-1730	Hindi	7410 9950 12045 13770
1730-1945	Arabic	9910
1745-1945	G.O.S-IV	7410 9950 11620 11935 13750 15075 15200
1945-2030	French	9910 13750
1945-2045	Hindi	7410 9950
2045-2230	G.O.S-V	7150 7410 9650 9910 9950 11715
2245-0045	G.O.S-I	7410 9705 9950 11620 13625
2300-2400	Hindi	9910 11740 13795

(AIR web site)

INDONESIA According to announcements, effective Apr-01, *Voice of Indonesia* plans to use three transmitters simultaneously for its Japanese service 1130-1200: 9525 11785 and 15150. Currently, only one channel is used—9525. (Mar 19/Yamada-JPN/EDXP/Padula-AUS)

ITALY Radio Speranza (Modena, Italy) is active again on 6231.24v kHz with fair modulation quality. Religious programs in Italian. ID "Radio Speranza." Heard at 2030 UTC; may be 24h? (Apr 19/Magrone-IT/Hard Core DX)

JAPAN NHK/Radio Japan schedule:

0000-0015	English	13650Y 17810Y
0000-0100	English	6145C
0100-0200	English	9515G 11860I 11870Y 15325Y 15590Y 17685Y 17835Y 17845Y
0130-0200	Bengali	11890S
0200-0230	Hindi	11890S
0200-0300	Japanese	5960C 11840Y 11870Y 15325Y 15590Y 17685Y 17810Y 17825Y 17835Y 17845Y 21610Y
0230-0300	Urdu	11890S
0230-0300	Portuguese	15590F
0230-0300	Persian	9540G
0300-0400	English	17825Y 21610Y
0300-0400	Japanese	5960C 9540G 9660F 11840Y 11870Y 11890S 15325Y 15590Y 17685Y 17810Y 17835Y
0330-0400	Swahili	6135A
0330-0400	Russian	15570Y
0400-0430	Arabic	9540G
0400-0430	Korean	15570Y
0400-0430	Spanish	9660F
0400-0500	Japanese	11840Y 15590Y
0430-0500	Chinese	15570Y
0430-0500	Russian	15355G
0500-0530	Spanish	11895F 15355G
0500-0530	French	17820S
0500-0530	Korean	15570Y
0500-0600	English	5975B 6110C 7230B 11715Y 11760Y 11840Y 13630Y 15590Y 21570Y
0530-0545	Italian	15355G
0530-0600	Chinese	15570Y
0545-0600	Swedish	15355G
0600-0630	Russian	11715 11760 Y
0600-0630	German	15355G
0600-0700	English	7230B 11740I 11840Y 13630Y 15230Y 21570Y
0630-0700	Chinese	17860Y
0630-0700	Bengali	15590Y
0630-0700	French	15355G
0700-0730	Hindi	15590Y
0700-0730	Arabic	15220A
0700-0800	Japanese	6145Y 6165Y 11740I 11840Y 11920I 15230Y 21570Y
0730-0800	Urdu	15590Y
0800-0830	Russian	6145 6165 Y

2100-2130 English 3980S 6480
2100-2200 Korean 5975
2300-0100 Korean 5975

S=via Skelton, UK (Koch-GER/Bueschel-GER)

MEXICO The "Other" Mexican Shortwave Stations:

XEUJ, Radio Linares. In contact with Lic. Sergio Jahaziel Becerra, Director General, he informs us that they are carrying out negotiations and necessary technical adjustments to improve the signal and increase coverage. Nevertheless, he does not give any tentative airdate.

XEYU, Radio UNAM, in spite of having some excellent installations, and renovated equipment for MW and FM, it is a real shame that its SW transmitter has not been updated, and is now more than 50 years old (I believe). We have already commented on the trouble the technical personnel have to go through when some tube quits working, and replacing it causes work and above all monetary costs. Even so, a great effort is being made to get the signal on 9600 kHz, which to tell the truth is very difficult to hear outside Mexico.

XEFT, La Jarocha. We heard comments last year from its director about a possible reactivation of 9545 kHz. Lamentably, it seems they have not been successful, since several months have gone by without any news. We suppose they are still working on this, but since there has been no response to our inquiry, we are unaware of the details.

XERTA, Radio Transcontinental de America. Several months after turning off the transmitter for an improvement in its power and antenna, it has not resumed being heard on 4800 kHz. We had been informed that they would resume programming in December, probably on new 4810 to avoid interference from R. Cultural [rather, Radio Buenas Nuevas, Guatemala -gh] and from a station in China [? On 4800? gh]

Radio Huayacocotla continues broadcasting on 2390 kHz. La Voz de los Campesinos is a community radio station, really worth tuning in; for now they have no QSL cards, but certainly the director, Lic. Martha Silvia Ortiz will reply in a kind manner. Remember that it uses only 500 watts. (Alegria-MEX/Nayarit DX Club/DX Listening Digest/Hauser-OK)

MONGOLIA Summer sked in English appears to be:
1030-1100 English 12085v
1500-1530 English 12015 12085
2200-2230 English 12015 12085
(Silvi + Seufert/DX Listening Digest/Hauser-OK)

NEW ZEALAND Here is the latest of the ever-changing *Radio New Zealand International* schedules:

0706-0959 11720

1000-1205 11720
1206-1505 6100 occ. special events
1506-1650 6145 occ. special events
1650-1850 6145 Mo-Fr
1851-1950 11725 Mo-Fr
1855-1950 11725 Sa/Su
1951-0705 17675
1955-0705 17675 Sa-Su
(Sainsbury/RNZI)

PAPUA NEW GUINEA Radio Western Highlands (3305) is off air for an indefinite period according to a report in today's "National" newspaper in Port Moresby. Staff are demanding the provincial government provide 24-hour security and replace vehicles stolen by thieves. In the latest incident, the station manager and driver were held up at gunpoint at a roadblock and their vehicle was stolen. Two vehicles were lost to thieves last year, and the transmitter was vandalised. Thieves also broke into the station manager's office. (Mar 31/Francis/EDXP/Padula-AUS)

3345 **Radio Northern** (non). A report heard on 4890 news was that the Radio Northern transmitter building has gone up in flames after an apparent electrical fault. An investigation is underway as the land used for the transmitter building has been the subject of land payment claims since 1972. The transmitter may be relocated as part of the rebuilding process, though no indication was given as to when the station would be back on air (Apr 17/Jary-AUS/Cumbre DX)

PERU 5460.43 Radio Bolivar, Bolivar; I received a phone from Julio Davila Echevarria, the station owner and director, sending kindly message of "Gracias por escucharme en onda corta" to all DXers. According to him, the station broadcasts at two times a day: 1100-1300 (morning transmission) and 2200-0100 (evening transmission) daily. Reports will be confirmed by QSL letter and should be sent to: Correo Central, Bolivar, Provincia de Bolivar, Departamento de La Libertad, Peru. Mail delivery may be via Cajamarca route. (Mar 21/TIN-JPN/Relampago DX)

RUSSIA Voice of Russia in English:
0100-0300 7125 9480 12070 15455 17565 17660
17690 21755
1200-1300 9945 15510 15460 15560
1300-1400 9945 15510 15560
1500-1600 12055 15005 15515
1700-1800 7300 9720
1900-2000 9720 11630 11980 15350 15455
2000-2100 9450 9710 9720 12070

(Mikhailov-RUS/RUS-DX/Bueschel-GER)

17266 (0805-1205) Murmansk local Radio (SSB mode). The relay of the program for fishermen. Being is noted at 0820 *Radio Station "Atlantika"*

(SSB mode). (Mar 21/Slavutskiy-RUS/RUS- DX)
Times may be one UT hour earlier now (Hauser-OK)

4940 Yakutiya noted for the first time the *Rep Radio "Miks-Master"* on Apr. 4 at 2250 on the freq 4940. The station has a standard commercial-musical format. There was an announcement of the telephone numbers in Yakutsk 42-03-02, 42-03-04, but without mentioning any addr. The freqs were also announced—102.5 and 4940. (Kovalenko-RUS/MIDXB/RUS-DX)

Schedule of Radio Free Chechnya:

0200-0500	7335 12045
0500-0515	11985 12045
0515-0700	11985 12045 15620
0700-0800	11985 12045
0800-1315	11985 12045 15620
1315-1400	7335 11985 12045 15620
1400-1415	7335 12045
1415-1700	7335 7345 12045
1700-1715	7335 7345
1715-2000	7335 7345 9940

(Mar 26/Ivanov-BUL/Bueschel-GER)

SLOVAKIA Radio Slovakia schedule, Summer 2000:

0100-0130	English	5930 7230 9440
0130-0200	Slovak	5930 7230 9440
0200-0230	French	5930 7230 9440
0700-0730	English	9440 15460 17550
0730-0800	Slovak	9440 15460 17550
0800-0830	German	5915 6055 7300
1300-1330	Russian	9440 11990 13715
1330-1400	German	5915 6055 7345
1500-1530	Russian	5920 7345 9535
1530-1600	Slovak	5920 6055 7345
1600-1630	German	5920 6055 7345
1630-1700	English	5920 6055 7345
1700-1730	French	5920 6055 7345
1730-1800	Russian	5920 7345 9485
1800-1830	German	5920 6055 7345
1830-1900	English	5920 6055 7345
1900-1930	Slovak	5920 6055 7345
1930-2000	French	5920 6055 7345

(Mar 26/Buckby-UK/Bueschel-GER)

SOLOMON ISLANDS The *Solomon Islands Broadcasting Corporation* has installed a new shortwave transmitter in Honiara to improve its signals to most parts of the country. The new transmitter, which carries SIBC's national service, Radio Hapi Isles, broadcasts on shortwave 5020. (BBCM/DXLD/Hauser-OK/EDXP/Padula-AUS)

SOUTH AFRICA Channel Africa summer 2000:

0300-0325	Swahili	6095
0300-0330	English	6035
0330-0355	French	6035
0400-0430	English	5955
0430-0455	Portuguese	3345 5955

0430-0455	French	9525
0500-0530	English	11720
0530-0555	Portuguese	11720
0600-0630	English	15215
0630-0655	Portuguese	15215
1300-1455	English	11720 21725 Sa
1300-1455	English	11720 17780 Su
1500-1530	English	17770
1500-1530	Swahili	17780
1530-1555	French	17770
1600-1630	Swahili	17860
1600-1630	English	9525
1630-1655	French	17860
1630-1655	Portuguese	3345 9525
1700-1730	English	17860
1730-1755	Portuguese	17860
1800-1830	English	17870
1830-1855	French	17870

(Channel Africa web page)

THAILAND Radio Thailand A-00 schedule:

0000-0030	English	9690* 9655 11905
0030-0100	English	15395* 9655 11905
0100-0200	Thai	15395* 9655 11905
0300-0330	English	15390* 9655 11905
0330-0430	Thai	15395* 9655 11905
0530-0600	English	15445* 9655 11905
1000-1100	Thai	11805* 9655 11905
1100-1115	Vietnamese	7260* 9655 11905
1115-1130	Khmer	7260* 9655 11905
1130-1145	Lao	6030* 9655 11905
1145-1200	Burmese	6030* 9655 11905
1200-1215	Malaysian	11805* 9655 11905
1215-1230	Indonesian	11805* 9655 11905
1230-1300	English	9885* 9655 11905
1300-1315	Japanese	11850* 9655 11905
1315-1330	Mandarin	11850* 9655 11905
1330-1400	Thai	11955* 9655 11905
1400-1430	English	9830* 9655 11905
1800-1900	Thai	9680* 9655 11905
1900-2000	English	7195* 9655 11905
2000-2015	German	9680* 9655 11905
2015-2030	French	9680* 9655 11905
2030-2045	English	9690* 9655 11905
2045-2115	Thai	9535* 9655 11905

*=via IBB facility at Udorn (Apr 1/Nieuwenhuis-HOL/EDXP/Padula-AUS)

UKRAINE Tentative sked of Radio Ukraine International:

0000-0100	English	5905 6020 9640
0100-0200	Ukrainian	5905 12045 13590
0200-0300	Ukrainian	6020 9640 12045 13590
0300-0400	Ukrainian	13590
0300-0400	English	6020 9640 12045
0400-0500	Ukrainian	6020 9640 11840 13590
0500-0600	Ukrainian	9620 11840 13590
0600-0700	Ukrainian	9620 9640 11705 11840 13590
0700-1100	Ukrainian	9620 9640 11705 11840 13590 21520

1100-1200	Ukrainian	9640 11705 11840 12045 13590 21520
1100-1200	English	21520
1200-1400	Ukrainian	9640 11705 11840 12045 13590
1400-1700	Ukrainian	9640 11705 11840 12045
1700-1800	Ukrainian	11705 11840
1700-1800	German	5905 9640 12045
1800-1900	Ukrainian	9640 11840 12045
1900-2000	Ukrainian	5905 6020 9640 12045 15530
2000-2100	German	5905 6020 9640 11950 12045
2000-2200	Ukrainian	15530
2100-2200	English	5905 6020 9640 11950
2200-2300	Ukrainian	5905 6020 9640 11950
2300-2400	Ukrainian	13590
2300-2400	German	5905 6020 9640 11950

(Egorov-UKR/RUS-DX/Bueschel-GER)

URUGUAY 6045.15 *Sarandi Sport*, 1441-1454+, 21 April, comments abt cycling competition in URG, rpts from mobile units nr's 1 & 2, from Paysandu & Maldonado, ads 'Telesvisor Grundig', 'Productos Cattivelli' & 'Bianchi, la ferreteria que mas vende', hrd thanks to info provided by HAN (Barrera-ARG)

VIETNAM Around 1155-1215 on Mar-28 the following domestic freqs were audible here in Bangkok:

Hanoi: 5035 and 6165 in // with Hmong Service, signing on at 1200; 5925 and 6020 in //, presumably 1st Domestic Service in Vietnamese; 5970 New freq, //7210 in Vietnamese to 1200 then continuing in Vietnamese; possibly 2nd Domestic Service; also noted //7210 around 0130 on Mar-26; 7210 in Vietnamese to 1200, then switch to Cambodian (not // External Service Cambodian on 7285); 4960 and 9875 still appear to be inactive.

** Update: Just to correct myself, a check of the few parallel MW channels audible here last night suggests that it should be the 1st Program of Voice of Vietnam on 5970 & in part on 7210, with the 2nd Program on 5925 & 6020. 5970 sounds rather under-modulated most of the time, Mar-30.

Provincials: *Lai Chau* just below 6383, with usual long, haunting melody on wind instrument with strings accompanying, from around 1155 to sign-on announcement at 1200; *Lao Cai* just below 5598 with 'wobbly' carrier, and in // on 6695 *Son La* on 4796; *Cao Bang* on 6501v with 'wobbly' carrier, producing variable heterodyne with *Qinghai* 6500—sounds just like an old-fashioned ambulance siren Presumed *Ha Giang* on approx 7156.5, little audible except carrier. No trace recently of *Yen Bai*, last noted around 6387 several months ago (Davies/EDXP/Padula- AUS)

7115 is another NF for Voice of Vietnam domestic sces—rather an idiotic choice, as it's co-channel with the longstanding Radio Thailand domestic channel at the same hours. The current schedule for the 1st & 2nd prgrams looks like this, but most timings are approximate or presumed:

1st Prgr?: 2200-1600 (Fri -1700) on 5970 & 7115, and with opt-outs? 2200-1600 daily on 7210

2nd Prgr?: 2200-1600 on 5925 & 6020 and 0155v-1000 on 7285

I believe the 'new' regional on 6564v is probably Yen Bai ex 6387v (but ID not confirmed), noted around 1300 on Apr-03 with rather weak signal and poor audio. (Davies/EDXP/Padula-AUS)

WESTERN SAHARA Polisario Radio has moved to 7460 kHz following the appearance of RTM Morocco on its previous 7470 frequency. The Polisario Front campaigns for an independent Western Sahara. There has been a recent clampdown on the Moroccan domestic media, following attempts to criticize Morocco's policy towards the disputed Western Sahara.

According to the Polisario radio's web site (<http://web.jet.es/rasd>), it broadcasts from Bir Lehlu in a Polisario-controlled part of Western Sahara, about 200 km south-west of Tindouf, Algeria—although this has not been confirmed. (BBCM/DXLD/Hauser) [guess this should be under CLAN-DESTINE...oh well-AQ] 

This month's cover was first used on the October 1981 FRENDEX.
It features four older covers from different eras.

Pirate Radio Report

Chris Lobdell • P.O. Box 146 • Stoneham, MA 02180-0146 • clobdell@mediaone.net

Hello and welcome to the May 2000 edition of the *Pirate Radio Report!* The Spring season is well along with us and hopefully your weather has been better than what we have been having up here in Massachusetts.

Spring and summer bring longer daylight which means that the 6955 kHz pirate band should propagate well all through the evening and night. Absorption of the signal will limit daytime reception to short distances. Look for some more Europirate operation around 15040-15070 kHz on Saturday evenings.

The ACE Changes Publishers

The pirate/ clandestine newsletter *The ACE [Association of Clandestine Radio Enthusiasts]* has a new publisher with the May 2000 issue. It is John T. Arthur of Belfast, New York. If you would like a sample issue or to subscribe, the new address for this is: John T. Arthur, 7994 Route 19, Belfast, NY 14711-8702. A one year subscription to the ACE in the US is \$21.00. Good luck JTA!

A hearty thanks go to Pat Murphy and Steve Rogovich for doing the publishing duties for the past few years.

Loggings [Lots of Europirates!]

Many thanks go to the following contributors. Ralph Brandi-NJ, Ross Comeau-MA, Fred Kohlbrenner-PA, Lee Silvi-OH, George Zeller-OH.

Jimmy The Weasel, 6955.3 USB, Noted on March 24th from 0428 UTC with the usual comments about "your stinkin' mamma". [Comeau-MA]

The Europirate *Laser Hot Hits*, was logged March 25th at 0407 UTC on 6219 kHz. Music heard included "Seasons In The Sun" and other oldies. [Comeau-MA].

RBCN [Radio Bob's Communication Network], was logged on 2nd April at 0110 UTC on 6955 kHz USB. This was the Stevie Nicks

commemorative program #22. [Zeller-OH] Sed no QSLs as this was a repeat program. [Silvi-OH]

Radio Blue Star, a Dutch Europirate, was heard on April 9th at 0035 USB with talking by a male announcer in English. Lots of old rock music on 6295 kHz. [Comeau-MA] Also noted on April 16th at 0150 UTC with the ID: "Best radio from The Netherlands...48 meter band...Radio Bluestar" [Kohlbrenner-PA]

Radio East Coast Holland, a Dutch Europirate was logged in PA in 11484.95 kHz on April 15th at 2332 to 0147 sign off. Euro/US pop music, IDs and address given as Box 663, 7900AR Hoogeveen, Holland. [Kohlbrenner-PA] Also heard here in Massachusetts. [Lobdell]

Radio Nova International, logged April 16th at 0310 USB on 6285.35 kHz with frequent IDs. Pop music including "House Of The Rising Sun". [Kohlbrenner-PA]

WHYP, Heard on April 8th with "K-Tel Record Night" and occasional interjections from Jimmy The Weasel. Program was in memory of James H. Brownyard, an American pioneer broadcaster. [Brandi-NJ]

WMFQ, Logged with alternative rock music including Elton John's version of "Lucy In The Sky With Diamonds" on April 9th at 0108 UTC on 6954.35 kHz USB. [Comeau-MA]

Voice Of Captain Ron Shortwave, was noted on April 16th on 6949.1 USB at 0240 UTC. Frequent IDs were given and an email address for reception reports. Lots of pop and rock music was played. [Comeau-MA]

Pirate Popularity Poll

Don't forget to vote for your best and worst pirate station for our poll coming up in June. Send your ballot in today.

Happy Pirate DX!

-Chris



QSL Report

Sam Barto • 47 Prospect Place • Bristol, CT 06010

Que Huong Vietnamese Radio & Newspaper

2074 E. White Rd., Suite 102, San Jose, CA 95131 Tel: (408) 223-3120 Fax: (408) 223-3121
Email: QHRadio@qsl.com Web-site: www.quehuongmedia.com

also submitted by
Glottzbach

San Jose 08 February 2000

Dear Richard,

Thank you for your communication of 8 Feb 2000 telling us of the programming you received 3 Feb 2000 at 17.510 KHz, 2344-2359 UTC. Monitoring of our broadcasts is important for the technical information we receive, as well as for information about our audience. Additionally, the stories of our listeners augment dimension of our transmissions, putting a "face" at the leading end of the shortwave.

As background, you should know that Que Huong Radio is a private Vietnamese Broadcasting Corporation mainly serving the Vietnamese American in the Northern California, United States since 1994. Que Huong Radio is the only 24 hour daily, all Vietnamese station outside Vietnam. We are broadcasting on 1120AM frequency.

Also, we have two one-hour programs sent daily to Vietnam on shortwave frequencies, as follows:

13.00-14.00 UTC at 9930 KHz

23.00-24.00 UTC at 17510 KHz

On shortwave programs which mainly broadcasted to Vietnam, we are trying to promote freedom and human rights for all Vietnamese people in Vietnam.

If you have any friend who is shortwave listener, please encourage him to send reception reports to us at above address. Reports can be in English and Vietnamese.

Again, thank you and enjoy your time on shortwave radio.

Khabarovsk f/d cd. in 2 mo. (Field-MI). 5930 f/d cd. in 6 wks. This was my 1500th SW station QSLed! (Field-MI)...Congratulations. Sam. 12065 via **Irkutsk** f/d "Sheep Jaula" cd. w/ schedule in 1 mo. (Barto-CT). **China Radio** 9450 via **Petropavlovsk-Kamchatskiy** f/d ltr. in 7 wks. v/s Richard E. Adams, Director. (Barto). **Voice of America** 7390 via **Novosibirsk** f/d "US Capitol at Night" cd. in 86 ds. (Davis-NM). 12065 via **Petropavlovsk-Kamchatskiy** f/d cd. in 102 ds. CARD listed site as "Petropavlovsk" which is not correct. (Davis-NM).

AUSTRALIA: Radio Australia 9445 and 11880 via **Shepparton** f/d "ABC Southbank Centre" cd. w/ schedule in 9 wks. (Barto-CT).

BELARUS: Radio Belarus International 7105 and 7210 via **Kalodziacy** f/d "19th Century Polychrome Tile" cd. in 2½ mo. w/ schedule and a pocket calendar. (Barto-CT).

BEIGIUM: Radio Vlaanderen International 21630, 13760 and 9925 f/d "Chicons au Gratin" cd. in 1 mo. (Barto). **Radio Television Belgique de la Communauté Française** 17570 f/d cd. in FR/EG in 25 ds. Also rcvd. schedule in Fr and a station sticker. (Glottzbach).

BHUTAN: Bhutan Broadcast

* **ing Service** 5030 f/d cd. w/ personal ltr. via registered mail in 5 wks. after only one rpt. v/s Thinley Tobgay Dorji gave me credit for designing a QSL card that the BBS used to base their new QSL card. (Maroti-NY) Great going!....Sam.

BONAIRE: Radio Nederlands

9590 f/d "Estacion de la Alegria" cd. was rcvd. in 5½ mo. for a special transmission. (Craighead-RS). 9820 f/d cd. in 2 mo. w/ schedule. (Barto-CT).

The Scream of the Butterfly
Digitally-mastered Pirat radio from the North Atlantic sea of.

Albert
"Not everything that is beautiful is beautiful."
and not everything that is beautiful is beautiful.

Bob
"Money doesn't talk."
it whispers."

George
"All the world is watching you, so take a
piece, but not too much."

Date 5/26/99 via **Craige F. Jmo**
Time 230 UTC Mode USB
Frequency KHz 6955 Power 100w

This is to confirm your reception of the Scream of the Butterfly. Thanks for listening! *Johnny Dodson*

IBC 中國華藝廣播公司

广播收听证

Richard A. Angelo 听友:

我司收到您关于 1999 年 12 月 17 日的广播收听报告, 频率 11590 KHz, 本地时间 10:39 ~ 11:10 (北京时间) 符合我公司节目内容。希望您继续收听和关心我公司的广播情况。(我公司短波广播频率有: 4940KHz, 6185KHz, 4830KHz, 11590kHz.)

特此证明

Radio Vlaanderen International 11980 f/d "Beginnohof" cd. in 17 ds. (Borokowski-NY).

BOTSWANA: Voice of America 15445 f/d "US Capitol" cd. in 6 wks. (Barto). 13710 f/d "Canyonlands National Monument in Utah" cd. in 75 ds. (Humenyk). f/d "Capitol" cd. in 5 wks. (Barto-CT).

BRASIL: ZYG525 Emissora Rural - A

* Voz do Sao Francisco 4945 f/d "Petrolina Aerial View" cd. for a 97 reception. Sticker rcvd. Your correct John, I think they are clearing up a backlog of reports...Sam. (Sgrulletta-NY). f/d cd. w/ station photo and decal in 4 mo. for a PT rpt, f/up and ms. v/s Lourinaldo Cavalcanti Andrade. (Myers-VA). 4945.1 f/d cd. w/ station photo in 2

mo. for a PT rpt. Decal rcvd. Addr: Praca M. Auxiliadora, 205 - centro, 56300-000 Petrolina - PE, Brasil. (Barto-CT). Radio Gaucha 11915 rcvd. a 6 panel folder in PT, SP and EG in 3 wks. for a registered rpt. (Glottzbach). ZYG201 Radiodifusora Pocos de Caldas Ltda. 4945 p/d 3 page ltr. w/ pocket calendar, business cd. and postcard in 3 1/2 wks. for a PT rpt. v/s Ronaldo Cioffi. (Barto-CT). ZYF204 Super Radio

Alvorada 2460.0 personal ltr. in 5 wks. for a PT rpt. v/s Jose Severiano de Freitas, Director. (Barto).

CAMBODIA: National Radio of Cambodia 11940.3 friendly p/d ltr. w/ my computer design* ed prepared cd. w/ f/d in 8 mo. for a registered rpt. sent from Hungary. v/s Kem Yan. Also rcvd. 2 schedules and 3 stickers. (Maroti-NY).

CAMEROON: Radio Yaounde / CRTV 4850 f/d ltr. in 65 ds. for a registered rpt. and US \$2.00. v/s James Achanyi-Fontem. (Raymond-NH).

CANADA: Radio Japan 6120 via Sackville f/d "Four Seasons" cd. in 1 mo. (Borokowski). 11705 cd. in 2 mo. w/ pennant and schedule. (Barto). Radio Austria International 6015 via Sackville f/d "Theatre on the Lake" cd. w/ schedule in 20 ds. (Borokowski). Radio Canada International 5960 via Sackville f/d "450th Anniversary" cd.

in 16 ds. w/ pennant & sticker. (Borokowski). 9755 f/d cd. in 1 mo. w/ pennant, schedule & folder. (Barto). 15425 and 11855 f/d "1973 World DX Friendship" cd. w/ sticker and schedule. (Barto). CHN 6130 f/d cd. in 22 ds. for \$1.00. v/s Scott Snailham. (Borokowski). f/d ltr. in 26 ds. for an E-mail rpt. 50 watts! The ltr. has a reproduction of a 1939 QSL at the bottom. (Neal-TX). Radio Korea International 9650 via Sackville f/d "Year of New Arts" cd. in 38 ds. (Borokowski-NY).

CELEBES: Radio Republik Indonesia Regional II Gorontalo 3264.6 lengthy 2 page ltr. in 5 wks. for an IN rpt. v/s Drs. Muh. Assad. (Barto-CT).

CHAD: Radiodiffusion Nationale * ionale Tchadienne 4904.5 f/d prepared cd., stamped and signed for a FR

இணைப்புகள் மற்றும் செய்திகள்



INTERNATIONAL BROADCASTING CORPORATION

செய்தி மற்றும் செய்திகள்

P.O. Box: 1505
London SW8 2ZH, U.K.
Tel: + 44 171 787 8000
Fax: + 44 171 787 8010
http://fastaccess.co.uk/ibc
e-mail: ibc@fastaccess.co.uk

RICHARD A. D'ANGELO
2216 BURKEY DRIVE
WYOMISSING, PA 19101
U.S.A.

19.10.99

Dear Sir,

I am pleased to hear from you all the way from U.S.A and would like to say Thank you for your excellent reception report.

The station you heard was ours. IBC is an International Tamil Radio, which broadcast 24 hours for Europe and an hour on short-wave for the rest of the world on a frequency of 16 meter 17.496 kHz at 2.57pm to 3.25pm (London time). We have about 600 000 listeners in all over Europe and a few thousand in rest of the world, specially in India, Sri Lanka and South Africa. Our programs include music, religion, news and current affairs, discussion and etc. Your report is helping us in knowing how far our transmission is well propagating.

Once again, Thank you for your report and I appreciate it. I hope you will keep on tuning to IBC in the future.

Yours Faithfully,

(Signature)

Manager
(S.Shivareajith)

QSL

Verification Card

Station Voice of the Hojshad

To Richard A. D'Angelo

This is to confirm your reception of our transmission dated
27 October 1991, 0224 - 0310 hours UTC on a
frequency of $6,560.8$ kHz with _____ watts.

M. Majid Taleghani
Mojafedines du peuple d'Iran
17 rue des Goids
F-95430 Amiens-sur-air
France

X

Signature & Official Seal

19-02-96

47 ds. (Glotzbach-NM). **China Radio International** 15540 and 17785 f/d "CRI Building" cd. in 2½ mo. (Barto). 11735, 9535, 15500 and 6950 f/d "Tuancheng - Round City" cd. w/ paper cuts and schedule in 7 wks. (Barto). 15260, 11685, 9440 and 9365 f/d "Stone Forest in Yunnan" cd. in 6 wks. (Barto). 17880 f/d "CRI Building" cd. in 2 mo. w/ schedule. (Barto-CT).

Nei Menggu Peoples Broadcasting Station 4525 and 4620 f/d "Terra Cotta Warriors of the Qin Shihuang Mausoleum in Xi'an" cd. in 7 wks. w/ schedule. (Barto).

CLANDESTINE: Que Huong Radio
* 9930 via **KWHR** (Hawaii) f/d ltr. in 3 mo. v/s Nguyen Khoi. (Craighead). 17510 via **KWHR** f/d ltr. in 3 wks. for an EG/VN rpt. (Craighead).

COLOMBIA: Colombo Radio 6065 personal ltr. on my 4th try for a SP rpt. v/s Dr. Jairo Aguirre who extended me greetings for being a DXer for 40 yrs! (Field-MI).

COSTA RICA: Adventist World Radio 9725 via **Alajuela** f/d prepared cd. in 153 ds. w/ gospel tract, station brochure, station schedule and a pocket calendar. (Humenyk).

CUBA: Radio Habana Cuba 9820 f/d cd. w/ personal ltr. and report form in 210 ds. for \$1.00. (Griffin-CA).

CZECH REPUBLIC: Radio Prague 9435 f/d "Zizkov Transmitter" cd. in 17 ds. w/ station schedule. (Borokowski-NY).

ECUADOR: HCJB 12015 and 9745 2 cds. rcvd. from the 1999 series. (Field-MI). 12015 f/d

"Jorge Zambrano" cd. w/ schedule in 6 wks. for the "EDXC Press Special Program" (Barto-CT). 9745 cd. w/ schedule and calendar in 66 ds. for 1 IRC. (Griffin). **Radio Oriental** 4780 personal ltr. in 59 ds. for a SP rpt. Sticker was rcvd. (Glotzbach) **ENGLAND: HCJB** 11760 via **Rampisham** f/d cd. w/ power and coordinates in 3 mo. Personal

rpt. w/ the assistance of the VZ DXer, Winter Monges. Thanks! (Myers-VA).
CHINA, PEOPLES REPUBLIC OF: China Hua-yi Broadcasting Company 4940 via **Fuzhou** f/d ltr. via registered mail in 42 ds. (Kusalik-ALB).

China National Radio 5010 f/d cd. in 27 ds. for a CH rpt. and \$1.00. (Raymond). **CPBS-1** 6750, 7935, 10260 and 11630 f/d "Chao Bell" cd. w/ schedule in 2½ mo. (Barto). 17580, 17550, 15550 and 15480 f/d "Yu Yuan Shanghai" cd. in 3 mo. (Barto). 15390, 12030 and 11960 f/d cd. in 2½ mo. (Barto). 9675, 11860 and 11925 f/d cd. w/ nesltr. in 2 mo. (Barto). **CPBS-2** 15285, 12080 and 15540 f/d cd. in 3 mo. (Barto). 11800, 11670, 9810 and 9500 f/d "Incense Burner" cd. w/ schedule in 3½ mo. (Barto). **China Radio International** 11675 via **Kunming** f/d "Temple" cd. in 12 wks. (Klinck-NY). f/d "Shanghai" cd. in



radio cristal

QSL

Estimado oyente:

Tenemos el gusto de confirmar su control de nuestra emision en 5013 kHz de fecha 15 de Septiembre de 1996 hora 02:44 a 01:04 UTC. Le saludamos atentamente

Aparato BR4
Calle Pepito Sacerdo No. 18, Altos
Santo Domingo, Republica Dominicana
Tel. (809) 566-5411

Fernando Ramirez

S. RICHARD A. D'ANGELO

2216 BURKEY DRIVE

WYOMISSING, PA 19610

U. S. A.

Transmitter: Jülich, Germany.

WEST COAST RADIO, IRELAND. (W.C.R.I.)The Irish Shortwave Service.
CLAREMORRIS, COUNTY MAYO, IRELAND.

We are pleased to confirm your reception report of our programmes on the frequency of 5910 kHz on 21/11/96

Thank you for writing to us. Best wishes from Ireland.

Michael Commins / Gerard Delaney

Photographic
Impressions

NORTH AMERICA
Thursdays 01:00 - 02:00 HRS U.T.C.
AFRICA/AUSTRALIA/NEW ZEALAND
Thursdays 18:00 - 19:00 HRS U.T.C.
EUROPE
Saturday 15:00 - 16:00 HRS U.T.C.

Richard A. D'Angelo,
2216, Burkey Drive,
Wyomissing, PA 19610,
U.S.A.

STANDARD
POST
CARD
RATE

CONNEMARA, IRELAND
JIFF 23 Photography by Peter O'Toole
Printed and Published in Ireland by John Hyde Ltd





Solid Rock RADIO

Date: 12-27-96

Time: 19:45 to 2030 UTC

Frequency: 6955 KHZ
FM 105.1
VIA WLMZ 9555 KHZ
3rd fl 4th str
Reporter: R D'Angelo

ltr. was rcvd. v/s Roger Stubbe. (Craighead-RS). 9870 personal ltr. rcvd. for their "Golos And" program. (Field-MI). * **Wales Radio International** 9735 and 9795 via **Merlin Network One** f/d paper QSL w/

site in 20 ds. (Kusalik). **Voice of America** 7170 via **Woofferton** personal ltr. in 45 ds. This was my first catch on my new R8B receiver. (Glotzbach-NM). **WYFR** 13720 via **Skelton** f/d cd. w/o site in 5 wks. Pocket calendar and schedule were rcvd. (Barto). **Radio Telefis Eireann** 15315 via **Skelton** f/d "River w/ Landscape" cd. in 25 ds. (Humenyk-ONT). **Radio Napa** 9915 via **Merlin Network One** f/d form ltr. in 11 1/2 mo. for an E-mail rpt. after a f/up rpt. v/s Nathan Morley. (Kusalik-ALB). **Radio Japan** 17695 via **Skelton** cd. in 2 mo. w/ schedule. (Barto). f/d cd. in 3 wks. v/s Yoshiki Fushimo. (Field-MI).

RADIO FREE EUPHORIA QSL# 102



Richard A. D'Angelo was turned on and tuned in to our euphoric smoke signal on the delicious date of 11-19-95 from the tripped out times of 1401 - 1450 UTC on the fresh-quency of 6099.8 AM.

Captain Danja

EUROPEAN RUSSIA: Radio Russia 9470 via **Moscow** p/d green "Logo" cd. in 2 mo. This was for the reception of the **Radio Chechnya Svobodna** program. (Craighead-RS). **EURO PIRATE: Radio Eastside** * 6245 f/d cd. w/ personal ltr. and station photo in 16 ds. for a snail mail rpt. and \$1.00. 50 watts. (Maroti-NY). * **Harold Krishna's Music Service** 11470 via **Shortwave Relay Service** f/d "Wicked Witch of the West" sheet in 110 ds. Caption on the sheet reads "I'll Get You My Pretties and Your Little Transmitters Too!" Use the Providence mail drop. (Comeau-MA).

GABON: Radio Japan 15355 via **Moyabi** f/d cd. w/ newsltr. and calendar. Schedules were also rcvd. (Glotzbach-NM). **GERMANY: Deutschlandfunk** 6190 f/d "DeutschlandfunkRadio Berlin" cd. w/ station name crossed off and "DLF" hand written in. All in 2 mo. for 1 IRC. (Sgrulletta-NY). **Good News World Radio** 9405 via **Julich** f/d "Telegraph Key" cd. in 1 mo. (Kusalik). **Adventist World Radio** 9640 via **Julich** f/d "For11 Site Artist Rendition" cd. in 18 ds. for 1 IRC. v/s E. Gysin-Ruf, Listeners Mail Department. Also rcvd. personal ltr., Julich QSL stamp, small AWR calendar, schedule. (Comeau-MA). **Radio Free Asia** 15385 via **Holzkirchen** p/d ltr. in 3 mo. (Barto). **Swiss Radio International** 9620 and 13790 via **Julich** f/d cd. in 5 wks. w/ schedule. (Barto) **Voice of America** 11725 via **Lampertheim** f/d "Mount Rushmore" cd. in 10 wks. (Field-MI). **Deutsche Welle** 9770 via **Julich** "Antenna" cd. w/ personal ltr. in 26 ds. (Glotzbach).

This is to certify that
Richard D'Angelo
Has Officially Heard
RADIO KAOS

On November 10, 1996 at 0131 UTC on 6955 KHZ

And is hereby awarded this

QSL Certificate

That is suitable for framing or wrapping fish.



Joe Messina
Head OI

Robert White
Legal Writer
Assistant OI

Andy Stone
Studio Engineer





WALES RADIO INTERNATIONAL - RADIO RHYNGWLADOL CYMRU
 Pros Kairon, Crymlynch, Pembrokeshire, SA41 3QE, Wales, UK Tel: +44 [0] 1437 563361 Fax: +44 [0] 1239 831350
 e.mail: Jenny@wri.cymru.net RealAudio Web Site: http://wri.cymru.net

Richard A. DiAngelo

We are happy to confirm that the transmission you heard on:

Date	Time (UTC/GMT)	Frequency	Transmitter	Programme
2-10-99	0200-0230	4795	RANPISHAM	CELTIC NOTES

is a Wales Radio International programme.

Thank you for getting in touch. We hope you continue to enjoy our programmes. Do try for the WTB travel competition - you don't have to be Welsh to enter, just correct identification of the events featured and have a good reason for wanting to come to Wales. Good luck.

* **Echos de la Verite**
 11965 via **Julich**
 f/d prepared cd. in 1 mo. w/ verite ltr. v/s Jean Claude Souilliot, General Manager. (Kusalik).

HAWAII: Que Huong Radio 9930 via **KWHR** p/d ltr. in 1 mo. for ms. (Kusalik-ALB).
HOLLAND: Radio Nederlands 9895 via **Flevo** f/d "Estacion de la Alegria" cd. in 5 1/2 mo. for reception of a special transmission. (Craighead-KS).
HONDURAS: HRMI Radio Mision Internacional 5890 f/d cd. w/ prepared cd. in 28 ds. after 2 f/up rpt. Total was 3 yrs. v/s Dr. James K. Planck, President IMF. (Kusalik-ALB).
ICELAND: Icelandic National Broadcasting Service 11402 and 13860 f/d post-card of Iceland in 1 mo. (Kusalik-ALB).

INDIA: All India Radio 3223 via **Shimla** f/d ltr. * w/ 2 prepared cds. both signed and stamped in 29 ds. after my 3rd f/up rpt. v/s V.K. Upadhyay, IBES Engineer. (Kusalik). 3945 via **Gorakhpur** ltr. in 37 ds. in a total of 4 yrs. after my 5th f/up rpt. v/s Dr. S.M. Pradhan, Superintending Engineer. (Kusalik).

IRAQ (Northern No-Fly Zone): Voice of the People of Kurdistan 4130 f/d prepared cd. w/ f/d personal ltr. in 9 ds. via the Berlin addr. v/s Salah Rashid. (Sgrulletta-NY).

ISRAEL: Galei Zahal 6442 f/d "Microphone Head" cd. in 39 ds. (Kusalik-ALB).

JAPAN: Radio Japan 7225, 9790 and 17810 cd. in 2 mo. w/ schedule. (Barto). 11815 and 9750 f/d "Paper String Art" cd. w/ sticker, pennant, newsltr. and sticker in 2 mo. (Barto).

JORDAN: Radio Jordan 11935 via **Qasr el Kharana** f/d "Shield w/ Persian Rug" cd. in 61 ds. w/ schedule and sticker. v/s Jawad Zada, Director. (Humenyuk).

KALININGRAD: Radio Nederlands 5835 f/d "Nature In Our Own Backyard" cd. in 36 ds. for 1 IRC. They did not circle the transmitter site on

Radio Free Speech's



Broadcast Celebration

Superior DX'er Richard DiAngelo
 Heard RFS on the Frequency of 6955 kHz

On the date of: 9-1-96

From the times of: 2151 — 2223 U.T.C.
 Look for Radio Free Speech on 6955, 6950, 7415, 13900 & 15043kHz with a celebration of Free Speech!

Station Manager: Bill O. Nights
 Bill O. Nights
 P.O. Box 1 - Salford, NY 14711 & P.O. Box 109 - Blue Ridge Summit, PA 17214

their card so I am going to return it requesting that they do so. (Comeau-MA).
LEBANON: High Adventure Radio 11530 and 6280 via **Mariavoun** f/d cd. in 39 ds. w/ info sheet. v/s Gary Hull, Station Manager. (Kusalik-ALB).

MALAGASY REPUBLIC: MCRV Special Broadcast 12070 via **Radio Nederlands** f/d cd. w/ site in 25 ds. (Kusalik). **Radio Vlaanderen International** 13745 via **Talata** p/d cd. in 4

* mo. (Craighead). **IBC Tamil Media Ltd.** 17490 via **Radio Nederlands** f/d ltr. in 2 wks. (Field-MT).
MOLDOVA: Voice of Russia 7180 via **Chisinau** cd. w/ personal ltr. and schedule

INFORMATION CULTURE

BROADCASTING DAILY IN ENGLISH ON 15415 KHZ/19N.
 SHORT WAVE FROM 18.00 - 19.00 HRS. G.M.T.

COMMENTS AND SUGGESTIONS ON HOW TO IMPROVE THIS BROADCAST ARE WELCOME WRITE TO:

THE AFRICAN SERVICE
 RADIO JAMAHIRIYA
 P.O. BOX 17
 HAMBURG - MALTA

THE AFRICAN SERVICE
 RADIO JAMAHIRIYA
 P.O. BOX 233
 TRIPOLI - S.P.A.L.A.

in 49 ds. (Glotzbach) f/d "Countyside" cd. in 34 ds. v/s Olga T'Roshima. (Borokowski-NY).

MONACO: Trans World Radio 9870 f/d cd. in 24 ds. for \$1.00 v/s John Moore. Also recvd. pennant, schedule and postcads. (Borokowski-NY).

MONGOLIA: Radio Free Asia 7460 p/d ltr.

RADIO NADECO

TRANSMITTING ON: 5.070 MHZ 60 meter band
15.685 MHZ 19 meter band

Q S L

Dear Friend

We herewith verify that you received a transmission of our station, RADIO NADECO, on Sept. 1991 at 0500 hours UTC on 5070 MHz

Type of Transmitter: D-8 made by Drake
Type of Antenna: 20 metre long wire antenna

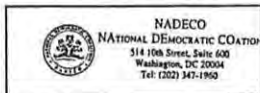

Official stamp

Martins Amegda
[Signature]

6 wks.(Barto). same in 2 mo.(Barto). 9845 same cd. in 6 wks.(Barto). 9760 f/d "US Capitol" cd. w/ schedule in 6 wks.(Barto). f/d "Sunrise at Greenville" cd. in 2½ mo.(Barto). 6110 f/d "US Capitol" cd. in 6 wks.(Barto). Vatican Radio 6020 via Pauliq f/d cd. w/ site in 3 mo.(Craighead-KS).

POLAND: Polish Radio Warsaw 9525 f/d "Krakow Panorama" cd. in 51 ds. w/ schedule and report form. v/s Rafal Kiepuszewski.(Borokowski-NY).

RUSSIA: Voice of Russia 11500 schedule and a personal ltr. signed by Tanya Stukova. Calendar rcvd.(Field-MI).

SAIPAN: Radio Free Asia 9455 via NHBI p/d ltr. in 2½ mo.

* (Barto). Voice of America 9355 f/d "Canyonlands Park in Utah" cd. in 10 wks. (Field).

SAO TOME: Voice of America 9845 f/d "Mount Rushmore" cd. in 2 mo.(Barto-CT). 6035 same cd. in 1 mo.(Barto). 4950 same f/d cd. in 75 ds.(Humenyk-ONT).

SINGAPORE: Radio Singapore International 12010 cd. in 2 mo.(Field-MI). 9820 f/d "Singapore City Hall" cd. in 1½ mo.(Barto).

SLOVAK REPUBLIC: Radio Slovakia International 5930 f/d "Michael's Tower" cd. in 77 ds.(Borokowski-NY).

SOUTH AMERICAN (Pirates):
Radio Cochiquiz 6950 f/d "Map/Logo" cd. in 87 ds. for 2 IRCs. Also rcvd. a personal ltr. in SP, station info in EG and a banner. Addr: R.C. Casilla 159, Santiago, Chile.(Comeau).

* Radio Natalie 6950 via Radio Cochiquiz f/d "Partial Clad Women" cd. in 28 ds. via Estonia addr.(Kusalik).

in 2½ mo.(Barto-CT).

MYANMAR: Myanmar Broadcasting Company 4725 cd. w/ schedule in 9 wks. for a 90 reception.(Barto). Myanma Television and Radio Department 4725 cd. w/ schedule in 2 mo. v/s Ko Ko Htway, Director. He promised new QSL card design will be forwarded as soon as it is ready.(Barto-CT).

NEW ZEALAND: Radio New Zealand International 6105 f/d cd. in 2 mo. w/ stickers. This was for a 1999-2000 reception in NZ. (Barto-CT).

PERU: OX7D Radio Oollasuyo 3250.4 * p/d ltr. in SP in 4 mo. for a SP rpt. on an 88 reception.(Barto).

PHILIPPINES: Radio Pilipinas 15190 p/d ltr. in 8 wks. for a taped rpt and \$1.00.(Klinck). f/d ltr. in 35 ds. for \$1.00. Schedule was rcvd. v/s Ric G. Lorenzo, Production Coordinator. Addr: Office of the Press Secretary, Philippine Broadcasting Service, Bureau of Broadcasting, 4/F Media Center Bldg., Visayas Ave., Quezon City 1100. (Comeau-MA). Voice of America 12040 f/d "Mount Rushmore" cd. in

देश/राज्य :
नाम : 'प्रसार भारती' (BROADCASTING CORPORATION OF INDIA)
पता/स्थान :
भारत सरकार
आकाशवाणी
मद्रास (चेन्नई)

PRASAR BHARATI
(BROADCASTING CORPORATION OF INDIA)



by AIR MAIL

TELEGRAMS: "AKASHVANI"
TELEPHONE 06854-22524

GOVERNMENT OF INDIA
ALL INDIA RADIO
JAYPORA (ORISSA)

संख्या D. O. No. JPR-3(7)98-E/ 4346

दिनांक Date 8th Nov, 1998

Richard A.D'Angelo,
2216 Burke Drive,
Wyomissing, PA 19610
U.S.A.

Sub:- Reception Report.
Ref:- Your letter dated the 8th November, 1998

Dear Sir,

We are very happy to learn that you have monitored our 50 KW Short Wave CEC Transmitter programme at 5040 K Hz on 07.11.1998 from 0555 to 0635 (Indian Standard Time). The programme details given by you in your letter were compared with our Studio Log-book and found them correct.

Thanking you,

Yours faithfully,

[Signature]
(A.C. SUDHANI)
Asstt. Station Engineer

SUNRISE RADIO
1458 AM

5850 SW (49 meter) SUNRISE UK

Richard A D'Angelo
2216 Barkley Drive
Wyomissing, PA 19610
U.S.A.

22nd Dec. 1998

Dear Mr. D'Angelo

RE: 5850 SW (49 METER)

Thank you for your reception report.

Yes we confirm that the transmission you received is correct.

Thank you very much for taking the time and interest to write to us at Sunrise Radio.

Yours sincerely

J. Swilling

Soumaya Sadeghi
PA to Chief Executive

need address help on this one.
(Field-MI). Voice of America 17725
via Greenville f/d "Liberty Bell"
cd. in 5 wks.(Barto). 15580 f/d
"US Capitol" cd. in 6 wks.(Barto)
17890 via Delano f/d "US Capitol"

cd. in 60 ds. w/ calendar and program guide. (Humenyk).
WIUC 9370.8 f/d cd. in 1 mo. w/ calendar and schedule.
(Barto). Dallas-Fort Worth Airport TIS 1640 and 1680
Marlin Field, 128 Oak, Hillsdale, MI 49242 also needs
this address....Anyone help?.....Sam. I need it too!

USA (Pirates): WMPQ 6950 QSL sheet in 40 ds.(Kusalik).
n/d ltr. in 6 wks. for 3 ms. Used the RI drop but the
QSL was postmarked from Fish Camp, CA. (Sgrulletta-NY).
6955 n/d ltr. in 34 ds. for 3 ms. Also rcvd. Thai Pizzeria
bhat coupons.(Neal-TX). Take It Easy Radio 6955 f/d sheet
#173 in 1 yr.(Dybka-TN). Voice of Captain Ron Shortwave 6955
f/d index cd. QSL w/ handwritten note in 6 wks. for an E-mail
rpt. (Sgrulletta-NY).

UZBEKISTAN: Jiban Band / Wave of Life 15470 via Tashkent f/d pre-

pared cd.
w/ IHRA cd. in
8 mo. This was
43 ds. after a
f/up rpt.(Kusalik).
same w/ f/d "Matrioshka" cd. in
9 wks. (Barto). Radio Vlaander-
en International 17685 f/d "Chi-
cons au Gratin" cd. in 1 mo. w/
schedule and sticker.(Barto-CT)
VIETNAM: Voice of Vietnam 9730 and
7145 f/d cd. w/ pennant in 2 mo
(Barto). Lai Chau Broadcasting
Station 6383.1 f/d cd. in 2 mo.
w/ schedule and pennant(Barto).
ZANZIBAR: Radio Tanzania Zanzibar
* 11734 f/d cd. in 54 ds. for a
registered rpt. and \$3.00. v/s
Khalid H. Rajab.(Raymond-NH).
ZIMBABWE: ZEC Radio 4 5012 via the
Guinea Fowl Station in Gweru
f/d cd. in 2½ mo.(Barto-CT).

I can't believe this. I used 12 pt.
type and just made it! **SAM**

ALMA I!MA



WQ 653

WQ 7400 AR

ተጋናጽ ለርገት ለርገት
ሰውራይ ባይቶ
ሊ/ደ ለግግራይ ወደፍጥነት



ERITREAN LIBERATION FRONT
REVOLUTIONARY COUNCIL
INTERNATIONAL RELATIONS OFFICE

جبهة التحرير العريترية
المجلس الثوري
مكتب العلاقات الدولية

Mr. Richard A. D'Angelo
2216 Barkley Drive
Wyomissing, PA 19610
U.S.A.
5 March 1998

Dear friend,

This is to confirm your reception of our radio transmission, *The Voice of Democratic Eritrea*, on the time and frequency you recorded; Congratulations! You happen to be one among the first persons around the world who reported back. After all, this transmission which preaches democracy, peace, reconciliation and justice will no doubt play a crucial role in the on-going pacification and democratization process in Eritrea and the entire region.

Thank you for the interest you have taken in our transmission. Take care and keep in touch.

Wishing you all the best.

Cordially,

Seyoum O. Michael
Alem. of Executive Committee
ELF-RC



Net Notes

Tom Sundstrom • P.O. Box 2275 • Vincentown, NJ 08088-2275 • Fax: 609-859-3226 • trs@trsc.com
http://www.trsc.com

Aurora displays spooked early man and still evoke tremendous response from those not fortunate enough to live at latitudes where aurora is normally visible. When there is a disturbance that expands the rings outward from the poles, radio communications are disturbed and we are torn between rushing outside to look and playing with the radio.

Such were the events last April 6-7. Unfortunately it was not visible here... but it did make a showing in the UK and the Netherlands. Some fantastic amateur photographs appeared soon thereafter at www.kersland.u-net.com/aas/aurora1.html. Trust me, it is well worth a look.

Pentti Lintujarvi, Helsinki, Finland, Webmaster of 1000 Lakes DX Page at www.geocities.com/Colosseum/Park/3232/dx.htm has been doing a yeoman job of finding new broadcaster URLs in Latin America. In April he found 9 broadcaster sites and regulator sites for Ecuador, Brazil, Chile, Venezuela and Peru. Rather than duplicate his work here, have a look through his Web site.

The **HFCC** (High Frequency Coordination Committee) is a non-profit voluntary group active in informal co-

ordination of frequency channels used in shortwave broadcasting. This worldwide committee holds meetings twice a year to resolve (for the most part) potential conflicts. Its AOO data may also be downloaded from www.hfcc.org/data/. The three prior broadcast seasons are also available.

Apologies to the person who sent a list of URLs re determining latitude and longitude. I misplaced the e-mail message, nowhere to be found, and the sender's name. The memory cells occasionally misfire. One of the significant sites mentioned was Microsoft's TerraServer at terraserver.microsoft.com/. Great satellite photos too... we found our house very quickly.

Be sure to check the **Easy Listening** column this month, as Richard Cuff has details of changes to the BBC Web site.

In the last month we've done a significant amount of research and work on the Winter SWL Festival pages. Links for transportation, weather, tourism, media and weather have been broken out onto separate pages, and a few more picture links have been added. Have a link to suggest? Tell me.

As always, **http://** is implied. And we're still waiting for the warm sun...

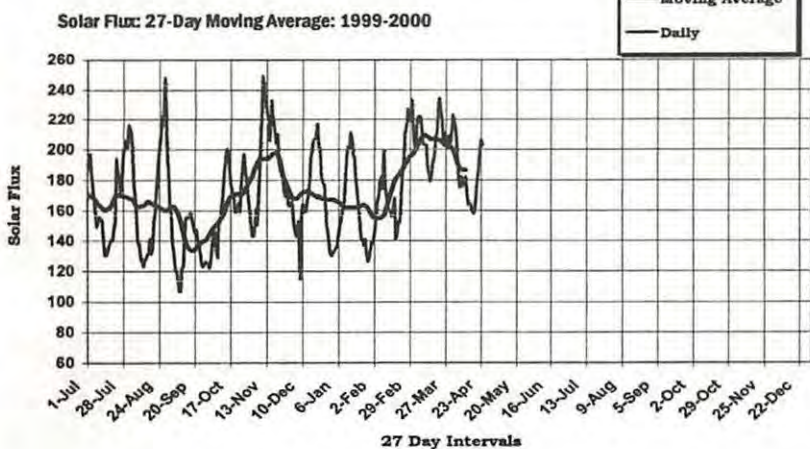

Contributors' Page

Fred S. Kohlbrenner • 2641 S. Shields St. • Philadelphia, PA 19142 • fkoehl@ix.netcom.com

DEADLINE FOR CONTRIBUTIONS IS THE 10th OF THE MONTH

The following members sent in contributions:

Brian ALEXANDER, Mechanicsburg, PA	NRD-545 AOR AR-7030 100' LW
Ralph BRANDI, Tinton Falls, NJ	R8 PR150 Dressler ARA60, 250' LW
Paul BROUILLETTE, Geneva, IL	R8 60' LW
Ross COMEAU, Andover, MA	R8 325' LW
Peter COSTELLO, Matawan, NJ	AR3030 DX-390 YB400 70' LW Tun-4A
Rich A. D'ANGELO, Wyomissing, PA	R8 HF150 FL-3 AD Sloper LW
Ed DIAMOND, Evansville, IN	R8 Grove SP-600 100' LW
Walt FAIR, Maracaibo, VENEZUELA	Sangean ATS-909 Realistic ant. and LW
Marlin FIELD, Hillsdale, MI	NRD-535D Eavesdropper LW
Bob FRASER, Cohasset, MA	Sony ICF-2003 ICF-SW100s 2m LW
George GLOTZBACH, Santa Fe, NM	R8B ARA-60
Jennifer GRIFFIN, CA	
Mark HUMENYK, Weston ONTARIO	Magnavox D-2935 AN-60 DX-SWL sloper
Fred KOHLBRENNER, Philadelphia, PA	R8 NRD-525 Datong FL-3 ANC-4 Sloper
Harold LEVISON, Philadelphia, PA	R8 R70 YB400
Jerry LINEBACK, Scranton, KS	Icom 746 beverage antennas
William McGUIRE, Cheverly, MD	DX-380
Jim MOATS, Ravenna, OH	FRG-7700 LW
Bob MONTGOMERY, Levittown, PA	NRD-535D R388 DX Pro active antenna
Gary NEAL, Sugarland, TX	Grundig YB-400
Ed NEWBURY, Kimball, NE	WJ-1000 R8 60'Sloper 20' loop
Jay NOVELLO, Wake Forrest, NC	R8A LWS
Takayuki Inoue NOZAKI, Tokyo, JAPAN	NRD515 NRD535 FRG7000
Mike PACE, Tipton, IA	
Denis PASQUALE, New Brighton, PA	DX-440 with a 10 meter long wire
Sheryl PASZKIEWICZ, Manitowoc, WI	R8 NRD-525 60' LW Eavesdropper
Stephen PRICE, Johnstown, PA	
Bob RAYMOND, Nashua, NH	R8B 20m 5/8 wave vertical
Betsy ROBINSON, Clinton, TN	Sony 2010 Indoor antenna
Chuck RIPPEL, Cornland, VA	WJ-HF1000A R8B R390A/SE-3 51s-1 LW's
Andy RUGG, Quebec, ONTARIO	Icom 735 Ham dipole
Giovanni SERRA, Rome, ITALY	NRD-525 AD Sloper
Arnaldo L. SLAEN, ARGENTINA	
Nobuo TAKENO, Tokyo, JAPAN	NRD-535D 10m LW
Fred TRESCHER, Philadelphia, PA	Sony 2010 FRG-7700
Charles WASHBURN, Robbinston, ME	
Jennifer WEINBRUM, Denver, CO	AOR-7030

George Glotzbach was in Virginia Beach on holiday recently and heard Wales Radio International. He is looking for the stations mailing address. If anyone can help, please send me the address and I'll forward it on to George.

Scoreboard Column totals and updates are due by May 15th. If you are not a Scoreboard contributor yet, why not begin by sending in your totals this month. The spotlight for the upcoming column is on North America.

Keep those contributions coming! 73s!



Tropical Band Loggings

Sheryl Paszkiewicz • 314 Riverview Drive, Apt 16 • Manitowoc, WI 54220 • spasz@dataplusnet.com

- 2310 AUSTRALIA CAAMA R 3/28 1202 EG pops (Line-KS)
 2325 AUSTRALIA CAAMA R 3/28 1202 EG pops (Line-KS)
 2379.9t BRAZIL R Educadora 4/13 0020 futbol, mx, chat (Nove-NC)
 2410 NEW GUINEA R Enga 3/28 1155 lang talk (Line-KS) 3/22 1125 tent ID, island mx (Mont-PA)
 2485 AUSTRALIA CAAMA R 3/28 1202 EG pops (Line-KS)
 2850 N KOREA KCBS 3/31 1159 class mx (Line-KS)
 3215 SULAWESI RRI Manado 3/28 IS at 1159 (Line-KS)
 3220 NEW GUINEA R Morobe 3/24 1045 local mx, ID (D'An-PA) 3/27 1156 lang talk, bird calls, conch shell (Line-KS) 3/22 1108 ID, talk, island mx (Mont-PA)
 3245 NEW GUINEA R Gulf 3/22 1110 talk, nx (Mont-PA)
 3260 NEW GUINEA R Madang 3/24 1106 natl nx, ID (D'An-PA) 3/28 1153 lang talk (Line-KS) 3/22 1115 nx, muffled, island mx (Mont-PA)
 3265 SULAWESI RRI Gorontalo 3/28 1152 IN pops (Line-KS)
 3320 S AFRICA R. Sonder Grense 4/10 2100 AK nx, mx (Wash-ME)
 3315 ADMIRALTY ISL R Manus 3/24 1103 EG nx, TC, mx (D'An-PA) 3/28 1153 EG talk (Line-KS)
 3325 SUMATRA RRI Palangkaraya 3/28 1159 IS (Line-KS)
 3335 NEW GUINEA R E Sepik 3/24 1042 talk, ID, TC, nx (D'An-PA) 3/28 1153 lang pops (Line-KS)
 3345 MOLUCCAS RRI Ternate 3/28 1151 IN pops (Line-KS)
 3355 NEW GUINEA R Simbu 3/22 1125 tent ID, talk, nx (Mont-PA)
 3360 GUATEMALA LV de Nahuala 3/13 0200 ID, mx, greetings (Robi-TN)
 3365 NEW GUINEA R Milne Bay 3/27 1050 instls, ID, nx (D'An-PA) 3/22 1125 tent ID, local pop mx (Mont-PA)
 3375 NEW GUINEA R W Highlands 3/22 1125 EG ID, nx, C&W mx (Mont-PA)
 3380t MALAWI MBC 3/11 0346 lang rel pgm, drama talk (Brou-IL)
 3385 NEW BRITAIN RENB 3/18 1115 talk, vocals (D'An-PA) 3/28 1151 lang talk, mx (Line-KS) 3/22 1115 US pops, tent ID (Mont-PA)
 3395 NEW GUINEA R E Highlands 3/24 1115 vocals, TC, ID (D'An-PA) 3/29 1151 local mx (Line-KS) 3/22 1056 local lang, pop mx (Mont-PA)
 3905 IRIAN JAYA RRI Merauke 3/28 1150 IN pops (Line-KS)
 3959 SULAWESI RRI Palu 3/28 IS (Line-KS)
 3976 KALIMANTAN RRI Pontianak 3/28 1149 IN talk, orch mx (Line-KS)
 3986 S KOREA Vo Hope 3/28 1149 KR orch mx (Line-KS)
 4000.2 SULAWESI RRI Kendari 3/28 1145 IN pops (Line-KS)
 *4052.5 GUATEMALA R Verdad 3/27 *1129 NA, anmt, El Tren del Evangelio pgm, TC, ID (TIN-JP)
 4725 MYANMAR R Myanmar 3/28 1203 Bamar nx (Line-KS)
 4753.3 SULAWESI RRI Makassar 3/28 1143 IN talk w/EG slang. ID'd as Ujung Pandang (Line-KS)
 4760 ANDAMAN ISL AIR Pt Blair 1202 EG nx at 1230 (Line-KS)
 4760 LIBERIA ELWA 4/2 0648 rel mx, hymns (Kohl-PA)
 4775 SWAZILAND TWR 3/15 0403 mx, GM preaching, ID (D'An-PA) 4/2 0410 GM rel pgm, hymns (Kohl-PA) 3/11 0403 GM rel pgm, hymns (Brou IL)
 4777 GABON R Gabonaise 3/25 2020 Afr pop mx, ID 2101* (Take-JP)

- 4780 GUATEMALA R *Coatan* 4/4 1100 ID, nx (Wash-ME)
 4789 IRIAN JAYA RRI *Fak-Fak* 3/28 1143 IN vocals (Line-KS)
 4790 PERU R *Atlantida* 3/12 0928 SP mx, anmts, ID (Raym-NH)
 4802 ECUADOR R *Oriental* 4/2 1039 talk, ment Oriental, drift (Take)
 4820 HONDURAS HRVC 3/28 0030 cmtry mx (Tres-PA)
 4825 BRAZIL R *Canção Nova* 3/11 2315 rel talk, ID (Brou-IL)
 4825 GUATEMALA R *Mam* 3/10 1055 SP mx, ID (Raym-NH)
 4832 COSTA RICA R *Reloj* 3/29 2310 SP cmtry (Tres-PA)
 4835 MALI R *Malienne* 3/17 2045 instl, chorus, ID (Serr-IT)
 4845 MAURITANIA ORTM 3/29 2300 AR mx (Tres-PA)
 4850 CAMEROON *Yaounde* 4/18 2100 EG ID, nx, FR ID, nx (Wash-ME)
 4850 ECUADOR R *Luz y Vida* 3/29 2300 SP cmtry (Tres-PA)
 4860 INDIA AIR *Delhi* 3/28 1230 EG nx, poor (Line-KS)
 4874.6 IRIAN JAYA RRI *Sorong* 3/28 1139 IN vocals, talk (Line-KS)
 4890 PAPUA NBC 4/5 1004 ID, ment Kina (PNG currency) and church svc (Bran-NJ)
 4910 INDIA AIR *Jaipur* 3/23 1720 chants, talk, instl, TP, ID (Serr)
 4914.6 PERU R *Cora* 4/8 1030 musica criolla, hosted by Juan Ramirez Lazo. ID (TIN-JP)
 4915 GHANA GBC 3/11 2340 lang/EG Afr pops, Tammy Wynette! EG nx (Brou-IL)
 3/29 2000 lang cmtry (Tres-PA)
 4920 INDIA AIR *Chennai* 3/28 1230 EG nx (Line-KS)
 4925 SUMATRA RRI *Jambi* 3/28 1138 NA, IN talk (Line-KS)
 4931 HONDURAS R *Costena* 3/13 0130 rel pgm to 0458* (Fiel-MI)
 4935 KENYA KBC 3/7 1843 chants, ment Nairobi, Sudan (Serr-IT)
 4950 ECUADOR R *Bahai* 4/20 0900 ID, nx, good (Wash-ME)
 4950 KASHMIR R *Kashmir* 3/23 1704 long chant, poor (Serr-IT)
 4955 COLOMBIA R *Nacional* 3/28 0000 LA mx (Tres-PA)
 4955 PERU R *Cultural* 4/2 1050 rel mx, talk, ID (Take-JP)
 4960 SÃO TOME VQA 4/7 0310 Daybreak Africa, ID (Bran-NJ) 3/14 0316 EG wx
 of Afr cities, ID (Brou-IL)
 4976 UGANDA R *Uganda* 4/7 0340 mx, nx in lang, EG ID & nx (Bran-NJ)
 4980 VENEZUELA *Ecos del Torbes* 3/28 0040 SP cmtry, mx (Tres-PA)
 4990 PERU R *Ancash* 4/6 0930 OA mx, cmtry, ads, ID (Wash-ME) 4/6 0942 Andean
 mx, ID (Take-JP)
 4995.6 PERU R *Andina* 4/4 1017 talk, Ids, ads (D'An-PA) 3/31 0956 Andean mx,
 talk, ID (Take-JP)
 5005 NEPAL R *Nepal* 1200 talk in lang, laughter, gone by 1310 (Wein)
 5009.6 MADAGASCAR R *Madagasikara* 3/7 1743 ment Mad, song, anmt (Serr)
 5010.4 ECUADOR R *Escuelas* 4/7 0304 anmts, buenos noches, NA (Bran-NJ)
 5015 TURKMENISTAN *Turkmen* R 3/23 1653 instl, anmts, TP (Serr-IT)
 5020 SOLOMON ISL *SIBC* 4/12 1000 EG ID, nx, fair (Wash-ME) 3/20 0950 sports,
 sked, ID as R Hapi Isles and SIBC, TC (Bran-NJ) 4/8 0807 So Pacific Games,
 ID, mx (Cost-NJ) 3/18 1130 island mx, ID, nx 1200 (D'An-PA) 3/28 1203
 EG nx (Line-KS)
 5025 CUBA R *Rebelde* 3/28 0200 SP mx & cmtry (Tres-PA)
 5035 VIETNAM *Vo Vietnam* 4/5 1157 Asian mx, ID ment Hanoi (Take-JP)
 5039.2 PERU R *Libertad* 4/4 1008 huaynos, ID, flute mx (D'An-PA) 4/1 1100 folklore
 pgm, canned ID (TIN-JP)
 5046.4 JAVA RRI *Yogyakarta* 3/28 1138 IN vocals (Line-KS)
 5050.1 TANZANIA R *Tanzania* 3/15 1659 drums, TP, anmt, ID (Serr-IT)
 5060.4 CHINA *Xinjiang* PBS 3/23 1646 song, anmt to 1648* (Serr-IT)



International Band Loggings

Wallace C. Treibel • 357 N.E. 149th Street • Seattle, WA 98155 • nwhikers@gte.net

- 5930 **SLOVAKIA RSI** in EG 0100, IS, ID, ethnic mx, mailbag, fqys, sked, national nx, //9440 (Field MI, Newbury PA Winterfest, McGuire MD 3/22)
- 5975 **GERMANY V of Hope** relay Juelich in EG/FR 0735, excited relig sermon in EG translated into FR, ID "High Adventure World Radio Network", QTH in UK (Serra ITALY 3/25)
- 5985 **CONGO RTV Congolaise** in FR 2038-2145, Afro pops, ID 2045 "Programme Nationale Congolaise", WYFR IS at 2155 s/on at equal co-channel strength (Novello NC 4/15, Takeno 4/7)
- 6010 **ITALY RAI** Rome in EG 0055, Italian forces become peacekeepers in Kosovo, g (Fraser MA 3/16)
- 6065 **IRAN VOIRI** Teheran in EG 0034, weapons inspectors in Pakistan, //9022 (Newbury DX-PA 3/13)
- 6120 **CANADA R Japan** relay in EG 1112, nx re radio studio theme park opening, g (Fraser MA 3/19)
- 6140 **CHINA R Canada Int** relay Xi'an in EG 1640, weekly business rpt, ID, QRM, p (Witham HI 3/15)
- 61537v **INDONESIA RRI Biak** in IN 1124, ballads, vocals, SCI 1159, nx from Jakarta, p (D'Angelo PA 3/24)
- 6155 **UNITED KINGDOM RTE** Ireland relay in EG 0134, soccer or rugby coverage, g (Newbury PA 3/13)
- 61578v **INDONESIA RRI Biak** in IN 1000, local pops, ID, fqy ancmt, g (Takeno 4/9) ED: See 61537 above
- 6200 **CZECH REPUBLIC R Prague** in EG 0200, IS, ID, rpt on NATO, into mx pgm, f (McGuire MD 3/19)
- 6210 **ETHIOPIA R Fana** in Oromiffa 0326, ID at 0329 in dialect, nx, lcl mx, f, //6940 (Kohlbrenner PA 4/2)
- 65201 **NORTH KOREA R Pyongyang** in JP 1124, mx pgm, //7580 (Brandt NJ 4/3)
- 6890nf **USA WGTG** McCaysville, GA in EG 0645, USB, cmntry on Supreme Court, ads, //5085 (Witham HI)
- 69566nf **PERU R La Voz del Campesino** in SP 0048, many ID's, lcl mx (chicha?), ments of Huarmaca, TC's, s/off w/NA by brass band at 0103 (Brandt NJ 4/4) ED: Wonder what happened to R Paraton same fqy
- 7195 **GERMANY R Liberty** relay Lambertheim in Belarus 1650, tlk w/EG translation, //15460 (Witham HI)
- 7250 **RUSSIA V of Vietnam** relay Armavir in EG 0230, ID's, tlk re amnesty, exc (Robinson TN 3/18)
- 9022 **IRAN VOIRI** Teheran in EG 0030, nx re OPEC, ID, fqy, sked, Koran chants (McGuire MD 3/22, Robinson TN 3/12) in EG 2010, "Press Review" re assassination attempt (Fraser MA 3/16)
- 91651 **AZERBAIJAN V of Azerbaijan** Baku 0157, xmtr on 0157, silence until *0214, 3 iterations of IS, ID?, into choral mx (Brandt NJ 4/14)
- 9485nf **SEYCHELLES FEBA** in Somali 1705, ment Somali, regional mx, IS, ID, //11885, f (Witham HI 3/19)
- 9495 **SWEDEN R Sweden** in EG 0130, tlk on autism/anorexia treatments, SW rock festival (Robinson TN) in SW 0200, bridge mx, ID, fqy, sked, nx, cmntry, g (McGuire MD 4/4)
- 9505 **JAPAN R Japan** Tokyo in EG 1450, studies difficult for foreign students in Japan (Newbury NE 3/2)
- 9535 **CHINA R Canada Int** relay Xi'an in EG *1330, IS, ID, nx, weak signal (Field MI 3/29)
- 9540 **UZBEKISTAN R Tashkent** in Uzbek 1645, Mideast mx, "Tashkent" ID hrd 1700, p (Witham HI)
- 9560 **HUNGARY R Budapest** in EG 0100, nx, ID, pgm on DX hobby, vg (Alexander PA 4/2)
- 9590 **SINGAPORE R Singapore Int** in EG 1127, nx magazine, many TC's, ID 1135 (Brandt NJ 4/3)
- 9600 **VATICAN STATE Vatican R** in CH 2200, IS, ID, rpt on Pope's visit to Israel, g (McGuire MD 3/21)
- 9605 **MOROCCO R Free Europe** in RO 0609, nx & related items, ID "R Europa Libre" (Field MI 3/18)
- 9620 **URUGUAY SODRE** Montevideo in SP 2130, pgm "Compositories e interpretes uruguayos", ID, fqy (Slaen ARGENTINA 3/27)
- 9650 **URUGUAY Emisora Ciudad de Montevideo** in SP 2116, romantic mx by L Am singers, ads, ID 2128, relay of MW outlet on 1370 khz, g (Slaen ARGENTINA 3/27)
- 9665 **MOLDOVA V of Russia** relay in EG 0335, history of Soviet Union, ID, mail, g (McGuire MD 4/11)
- 9705 **MEXICO R Mexico Int** in SP/EG 0320, Mexican mx, many ID's incl EG, QTH (Brandt NJ 4/13)
- 9720nf **TUNISIA R Tunis** Sfax in AR 2100, nx, //7225, abrupt s/off at 2102, cont'd on //7225 (Brandt NJ 3/22)
- 9795nf **CANADA Voice of Vietnam** relay via Sackville, NB in VT 0400. Occasional inserts in French plus musical breaks. Tuned in too late to hear the EG xmsn which is listed for 0300-0359, exc (Treibel WA 4/21)
- 9840 **RUSSIA V of Russia** St Petersburg in Farsi 1655, tlk, IS, ID, into AR 1700, p (Witham HI 3/15)

- 9870 AUSTRIA *RAI* Vienna in EG 0145, mailbag pgm, ID, E-mail address, g (McGuire MD 4/9)
- 9885 IRAN *VOIRI* Sirjan in EG 1615, rpt on militia in Afghanistan, mx, ID, fqy, sked, f (Witham HI 3/18)
- 9930 HAWAII *KWHR* Naalehu relay of Que Huong Radio in VT 1300-1400, mostly tlk (Field MI 3/30) in VT 1400 with relay of Radio Free Asia, ID in EG at start of pgm (Field MI 3/31)
- 9965 ARMENIA *R Intercontinental* in GM 1910, relig pgm ending with "Hallelujah, Amen", mx, addresses, in GM at end of pgm, also ID in EG, Yerevan QTH, carrier off 1931 (Brandt NJ 3/19)
- 11460nf NORTH KOREA *R Pyongyang* in SP 0150, mx, IS, ID at 0200, into FR pgm, g (Witham HI)
- 11550 TAIWAN *WSHB* relay via Taipei in EG 1200, WSHB Christian Science Broadcast (Field MI)
- 11590 CHINA *Huyai BC Corp* Chengdu in Mandarin/Amoy *0850, CH mx pgm, commercial service, (Field MI 3/9) ED: Excellent DX catch as outlet has only listed power of 15 kw.
- 11640nf SOUTH AFRICA *TWR* relay in EG 0605-0615*, tlk "What is Heaven?", hymn, ID, IS (Witham 3/9)
- 11650nf SEYCHELLES *FEBA* in Dhivehi 1650-1700*, instrum'l mx, ID, xmtr interrupts (Witham HI 3/17)
- 11705nf GERMANY *BBC* relay Biblis in TK *1500 immediately after VOA Philippines s/off, BBC IS and ID at s/on, mostly tlk with EG inserts, f-p with noisy QRN during last 20 mins of pgm (Treibel WA 4/7)
- 11720nf GUAM *AWR* relay in Mandarin 2155, tlk, inspirational mx, ID "Voice of Hope"//11970 (Witham HI)
- 11734 TANZANIA *RT Zanzibar* in AR 1935-2005, instrum'ls, vcls, adj chan QRM (Kohlbrenner PA 3/31)
- 11740 SINGAPORE *R Telefis Eireann* relay in EG 1013, ID 1014 as Radio One, sports update, possible Merlin rebroadcast, rapid fades or flutter but good audio (Montgomery PA 4/3)
- 117505 ALGERIA *R Algiers Int* in EG 2040, ID's, nx highlights, AR vcls, US pops, f (Kohlbrenner PA 3/31)
- 11765nf ALASKA *KNLS* Anchor Point in EG 0845, ID, relig tlk, Christian Roundtable, qrm (Brandt NJ 4/11)
- 11770nf UNITED ARAB EMIRATES *UAE Radio* in AR 0255, monotone tlk, prayers, //21735 (Witham HI)
- 11785 RWANDA *Deut Welle* relay in PT 2000, "Portugese to Africa", nx, ID, g (Fraser MA 3/16)
- 11787v IRAQ *R Iraq Int* Baghdad in AR 2000, ID, nx at 2100, lots of AR mx, exc signal (Price PA 3/24)
- 11830 VATICAN STATE *Vatican R* in CH 2200, IS bells, ID, E Asian svce, relig pgm (McGuire MD 4/4)
- 11860v INDONESIA *RRJ Nasional Dua* in IN 2250, tlk, Song of the Coconut Islands, ID, nx (Brandt NJ 4/13)
- 11895 JAPAN *R Japan* Tokyo in SP 0500, IS, NHK ID, into political nx, g (McGuire MD 4/11)
- 11915 BRAZIL *Radio Gaucha* in PT 2313, sports report, ID, commercials (Brandt NJ 4/13)
- 11970nf IRAN *VOIRI* Teheran in EG 0050, national & world nx, ID, political cmntry, g (McGuire MD 4/11)
- 12080 RUSSIA *V of the Mediterranean* relay via Moscow in EG 1900-2000, nx, Euro pop mx, ID, list of upcoming schedule changes, g (Alexander PA 4/1)
- 12085 MONGOLIA *V of Mongolia* in EG 1049, mailbag, sked for EG prgming, g (D'Angelo PA 3/28)
- 13640nf TURKEY *VOT* Ankara in EG *2157-2250*, IS, pips, ID, sked, nx, press review, g (Moats OH 3/26)
- 13650 UNITED KINGDOM *R Canada Int* relay in Ukranian/EG 1558, IS, ID in EG, tlks, f-p (Field MI 3/23)
- 13675 UNITED ARAB EMIRATES *R Dubai* in EG 1602, pgm on Islamic history, //15395 (Serra ITALY) in EG 0331, world nx, ID, more Islamic history, g (McGuire MD 3/17)
- 13695 THAILAND *R Thailand* in EG 0038, rebels fire hrd in Chechnya, tlk on weapons (Newbury DX 3/13)
- 13700 NETHERLANDS *RN Flevo* in DT 2130, nx, bell chimes, ID, fqy, sked, Web site, g (McGuire MD 4/4)
- 13730 AUSTRIA *RAI* Vienna in EG 0128, ID, nx, "Report from Austria", avalanche rescue (Moats OH 4/3) in EG 0138, tlk on age of marriage, getting older, candy making by hand, exc (Levison PA 3/29)
- 15075 INDIA *AIR* Bangalore in HD 0410, vocal duet, brief tlk by YL anc, p-f (D'Angelo PA 3/5)
- 15105 ROMANIA *RRJ* Bucharest in EG 0413, details re upcoming pgms, ID (Diamond IN 3/26)
- 15115 NEW ZEALAND *RNZI* in EG 0940, back again on this fqy, exc (Montgomery PA 4/3) in EG 0750, recorded mx, pips, off the air for several minutes due to fire alarm, interview (Brandt NJ 4/11)
- 15115 ECUADOR *HCB* Quito in EG, musical mailbag, Cumbay ya song, exc (Pace 3/31)
- 15140 OMAN *R Oman* in EG/AR 1442, interview, pop song, ID, into AR pgm 1500, f (Serra ITALY 3/19)
- 15150 INDONESIA *V of Indonesia* 2015-2100*, C&W mx, ID, mail address, IN mx, nx, f (Fraser MA 3/15)
- 151849 EQUATORIAL GUINEA *R Africa* in EG 2246, preacher w/sermon, s/off w/NA 2259 (Brandt NJ 4/5)
- 15210 CHINA *China R Int* Jinhua in EG 1006, nx, ID 1007, f, //11730 better (Montgomery PA 4/3) 600 kw!
- 15235 IRAN *VOIRI* Teheran in Bosnian 0610, Balkan nx, mx, //15510, 17585, all poor (Witham HI 3/12)
- 15240 AUSTRALIA *R Australia* in EG 0458, tlk re various movies and movie stars (Diamond IN 3/26)

- 15255nf **SWEDEN R Sweden** in EG 2129, IS, ID, fgy, "60 Degrees North", pgm sked, nx, //9435 (Moats 3/29)
- 15340nf **ROMANIA RRI** Bucharest in PT 0100, nx, frequent ID's (Diamond IN 3/26)
- 15355 **OMAN R Oman** in EG 0300-0400, Big Ben chimes, relig tlk, introduction to Koran, recitations in AR and EG translations w/cmtnry, nx 0315, pop mx, list of lcl events, into AR 0400, vg (Alexander 3/11)
- 15400 **UNITED ARAB EMIRATES R Dubai** in EG 0330, IS, ID, rpt of Pope's visit to Israel (McGuire 3/21)
- 15435 **LIBYA V of Africa** in EG 1725, ID, nx, good level but mixing with Saudi Arabia in AR, nx in EG also hrd at 2028, 2330, and 0130 (Alexander PA 4/1, Trescher PA 3/28)
- 15485 **PAKISTAN R Pakistan** in Urdu 0115, tlk, prayers, poor, //17895 also poor (Witham HI 3/19)
- 15565 **NETHERLAND ANTILLES R Vlaanderen Int** Belgium relay via Bonaire in EG 2230-2300, "Radio World", mailbag, "Tourism" (Brouillette IL 3/26)
- 15725nf **CONGO R Canal Liberte** Kinshasa in FR/EG 2301*, C&W mx, NA?, abruptly off (Rippel VA 3/18)
- 15820 **ARGENTINA R Rivadavia** feeder in LSB, Buenos Aires in SP 2015, pop mx, ads, p (Witham HI 3/18) in SP 2055, cmtnry on econ situation in Argentina, bulletin nx, ID (Slaen ARGENTINA 3/27)
- 16000 **AUSTRALIA VNG Time Station** 0931 w/time pips, full ID's (Costello NJ, Brandi NJ) Only 5 kw!
- 17535 **ISRAEL Kol Israel** Tel Aviv in EG 1520, neo-Nazis march in Berlin in support of Austrian PM, wx rpt (Newbury DX-PA 3/12) in EG 2000, rpt on Pope's tour in Israel, exc (Robinson TN 3/26)
- 17575nf **QATAR QBCS** Doha in AR 1530-1600+, mostly tlk and chants, ID 1600, heavy QRM from RTBF Belgium relay on one side and V of Russia on the other (Treibel WA 4/11)
- 17580 **AUSTRALIA R Australia** in EG 0650, music show with Dr Boo of Triple-J, nx (Brandi NJ 4/11)
- 17605 **NETHERLAND ANTILLES R Nederlands** relay via Bonaire in EG 1932, nx re meeting at The Hague about water rights, Russian PM Putin, voting in Russia etc., exc (Levison PA 3/25)
- 17630 **OMAN BBC** relay Masirah Island in EG 1645, sports scores, BBC pgm changes, f (Witham HI 3/18)
- 17735nf **ROMANIA RRI** Bucharest in EG 1707, nx bulletins, "Focus", mailbag, //17805 (Moats OH 4/9)
- 17770 **EGYPT R Cairo** in AR 0000, IS, ID in AR, nx, fair sig with static (Fair VENEZUELA 3/27)
- 17790 **SINGAPORE BBC** relay in EG 0005, nx, rpt on oleander poisoning in Sri Lanka, exc (Fair, VEN 3/27)
- 17805 **USA R Taipei Int** relay Okeechobee, FL in SP 2330, info on Taiwan, pop mx, ID, f (Fair VEN 3/28)
- 17815 **ROMANIA RRI** Bucharest in RM 2340, lcl ballads, cmtnry, ID, QTH, abruptly off 2355 (Fair 3/28)
- 17835nf **GUAM KSDA** Adventist World R in Cantonese, tlk, relig mx, IS, ID, g (Witham HI)
- 17850 **COSTA RICA REE** Spain relay in SP 1700, IS, ID, pips, live sporting event, g (McGuire MD 3/12)
- 17870 **SOUTH AFRICA Channel Africa** in EG 1802, nx, sports info, ID, "Newswatch", f (Serra ITALY 3/7)
- 17880nf **GUAM KSDA** Adventist World R in Mandarin 2325, tlk, "Rock of Ages", ID in EG, f (Witham HI)
- 21455nf **USA WYFR** Okeechobee, FL in EG 1657, prayers, fgy, QTH, ID, IS, "Open Forum" (Moats OH 3/26)
- 21455nf? **UNITED KINGDOM Galaxy Radio** in EG 1240, reggae mx, ID with fgy quote of "102.5 FM", abrupt switched to a different feed at 1253 (Brandi NJ 4/8)
- 21455nf? **UNITED KINGDOM Virgin Radio** in EG 1253 after abrupt switch from Galaxy feed, pop mx, ads, UK nx, ID at 1303, "Rock and Roll Football" w/Terry Venables & Chris Evans, other mx (Brandi NJ 4/8)
- 21715 **TURKEY VOT** Ankara in TK 0100, variety of mx, time pips, ID, g (Fair VENEZUELA 3/28)
- 21725 **AUSTRALIA RA** in EG 0135, tlk, mx, aboriginal culture, ID, nx, f (Fair, VENEZUELA 3/27)
- 21740 **AUSTRALIA RA** in EG 2100, nx items, cmtnry, tlk on Mozambique flooding, g (Levison PA 3/5)
- 21745 **CZECH REPUBLIC R Prague** in EG 1557, multi-lingual ID's, nx bulletins, wx, feature on computer games, cmtnry on Czech TV and Czech language, f-p (Moats OH 4/2)
- 21775 **GERMANY Deut Welle** Nauen in EG *1559, IS, ID, billboard, "Newslink", press review (Moats 4/6)
- 25930usb **COSTA RICA RFPI** in EG 1830, ID, fgy ancmt, rock mx, relig tlk, g (Fair VENEZUELA 3/26)

Clandestine, Tentative, Presumed, or Unknown

- 7470 **CLANDESTINE National Radio of the Saharan Arab Demoratic Republic** in AR 2249-2312*, talk by OM, vocals, ID at 2300 followed by OM in SP w/ID and ancmts, nx, f (D'Angelo PA 3/18)
- 95173 **CLANDESTINE Eritrea Voice of the Sudan** in AR 0520, speech w/applause, ment Sudan, jamming, p (Witham HI 3/14) ED: Listed power for this one is only 1 kw!
- 11530 **LEBANON(p) V of Hope(p)** in EG? 1509, pop song, into AR at 1549 recheck, p (Serra ITALY 3/19)
- 11790 **NO MARIANAS R Free Asia** via Tinian relay in Mandarin 1800, ID in EG, tlk, CH mx (Witham HI)
- 13625 **NO MARIANAS R Free Asia** via Tinian relay in CH 2128, tlk re CH beer, EG inserts (Raymond NH)
- 15355 **OMAN(t) R Oman(t)** in AR 0334-0356 f/o, songs by Bee Gees, Steppenwolf, & Gladys Knight and the Pips, TC, partial ID, fair sig with very deep fades (D'Angelo PA 4/3)
- 15680nf **UNIDENTIFIED SITE R Free Asia** relay in Burmese(p) *0027, IS, ID in EG, g (Costello NJ 4/6) 

English Schedules

Mark J. Fine • 11252 Cardinal Drive • Remington, VA 22734-2032 • fineware@erols.com
<http://www.erols.com/fineware/>

Prepared 21 April 2000.

0000-0015		Radio Japan	6050.0eu	6145.0na	6155.0eu	13650.0as	17810.0as
0000-0015		V. of Cambodia	11940.3as				
0000-0027		Radio Prague Int'l	11615.0na	13580.0na			
0000-0030		BBC World Service	3915.0as	5965.0as	5975.0na	6175.0na	6195.0as 7110.0as
			9410.0me	9590.0am	9915.0sa	11945.0as	11955.0as 12095.0sa
			15280.0as	15310.0as	15360.0as	17615.0as	17790.0as
0000-0030		Radio Cairo	9900.0am				
0000-0030		Radio Thailand	9655.0af	9690.0af	11905.0af		
0000-0030	mtwhfa	Radio Yugoslavia	9580.0na				
0000-0030		Sri Lanka B'casting Corp.	4940.0do				
0000-0030		VOA	7215.0as	9770.0as	11760.0as	15185.0as	15290.0as 17740.0as
			17820.0as				
0000-0030	twhfa	VOA	5995.0am	6130.0ca	7405.0am	9455.0af	9775.0am 11695.0ca
			13740.0am				
0000-0030		WRMI Miami FL	9955.0am				
0000-0045		All India Radio, Delhi	7410.0as	9705.0as	9950.0as	11620.0as	13625.0as
0000-0056		Radio Pyongyang	4405.0va	11460.0na	11710.0na	13760.1na	15180.0na
0000-0100	s	Global Sound Kitchen	3955.0eu	6140.0eu	7325.0eu		
0000-0100		KALJ Dallas TX	13815.0va				
0000-0100		KTBN Salt Lake City UT	15590.0na				
0000-0100		NBC Windhoek, Namibia	3270.1af	3289.9af			
0000-0100		Radio Australia	9660.0pa	12080.0va	15240.0pa	17580.0pa	17750.0as 17795.0va
			21740.0va				
0000-0100	s	Radio Finland	11985.0na	13770.0na			
0000-0100		Radio Ukraine Int'l	5905.0eu	6020.0eu	9640.0eu		
0000-0100	sm	WWBS Macon GA	11915.0eu				
0000-0100		WWCR Nashville TN	3215.0na	5070.0na	7435.0na	13845.0na	
0000-0100		WYFR Okeechobee FL	6085.0na	9505.0na			
0000-0130		FEBC Manila	15175.0as				
0000-0130		Radio Kiribati	9809.9do	9825.0do			
0000-0130		Radio Netherlands	6165.0na	9845.0na			
0000-0200		Radio Exterior de Espana	6055.0na				
0000-0200		WEWN Birmingham AL	5825.0va	13615.0na			
0000-0200		WSHB Cypress Creek SC	9430.0na	15285.0am			
0000-0300		R. for Peace Int'l	15049.0va	25929.9uf			
0000-0300		WRNO New Orleans LA	7355.0na				
0000-0400		KWHR Naalehu HI	17510.0as				
0000-0400		WINB Red Lion PA	12160.0am				
0000-0500	s	a SIBC Solomon Islands	5020.0do				
0000-0500		a SIBC Solomon Islands	9545.0do				
0000-0500		WHRA Greenbush ME	7580.0na				
0000-0515		CBC Northern Service	9625.0do				
0000-0600		HCJB Quito Ecuador	9745.0na	15115.0na	21455.0uf		
0000-0600		WBCQ Monticello ME	7415.0na	9330.0na			
0000-0600		WGTC McCaysville GA	5085.0va	6890.0uf			
0000-0630		Kenya BC Corp	4885.0do	4915.0do	4935.0do		
0000-0700		Nat'l BC, Papua NG	9675.0do	11890.0do			
0000-0705		Radio New Zealand Int'l	17675.0pa				
0000-0830		ABC Alice Springs	4835.0do				
0000-0830		ABC Katherine	5025.0do				
0000-0830		ABC Tennant Creek	4910.0do				
0000-1000		Caribbean Beacon	6090.0am				
0000-1000		Voice of Guyana	3289.8do	5949.4do			
0000-1000		WHRI Noblesville IN	5745.0na	7315.0sa			
0000-1000		ZLXA New Zealand	3935.0do	7290.0do			
0000-1100		Radio Vanuatu	3945.0do	4960.0do	7260.0do		
0000-1100		SBC Radio 1, Singapore	6150.0do				
0000-1600		RTM Radio 4, Malaysia	7295.0do				
0015-0100		Radio Japan	6050.0eu	6145.0na	6155.0eu		
0030-0100		BBC English Teaching	9600.0as	17615.0as			
0030-0100		Radio Thailand	9655.0as	11905.0as	15395.0na		
0030-0100		Radio Vilnius, Lithuania	9855.0na				
0030-0100	twhfa	VOA	5995.0am	6130.0ca	7405.0am	9455.0af	9775.0am 11695.0ca
			13740.0am				
0030-0100		VOA Special English	7215.0as	9770.0as	11760.0as	15185.0as	15290.0as 17740.0as
			17820.0as				
0030-0130		VOIRI Teheran	9022.1am	9835.0ca	11970.0na		
0030-0200		BBC World Service	5965.0as	5975.0na	6175.0na	6195.0as	9410.0me 9590.0am
			9915.0sa	11955.0as	12095.0sa	15280.0as	15310.0as 15360.0as
			17790.0as				
0030-0200		Sri Lanka B'casting Corp.	4940.0do	6005.0as	6075.0as	9730.0as	15425.0as
0030-0200	twhfa	WRMI Miami FL	7385.0na				
0030-0200	sm	WRMI Miami FL	9955.0am				
0050-0100		Int'l BC Tamil	11570.0as				
0050-0110		RAL Rome	6010.0na	9675.0na	11800.0na		

0100-0115		Radio Finland	11985.0na	13770.0na					
0100-0127		Radio Prague Int'l	7345.0na	11615.0na					
0100-0127		Voice of Vietnam	7250.0na	9695.0na					
0100-0130		Radio Budapest	9560.0na						
0100-0130		Radio Canada Int'l	5960.0am	9755.0am	11715.0am	13670.0am	15170.0am	15305.0am	
0100-0130		Radio Slovakia Int'l	5930.0na	7230.0ca	9440.0sa				
0100-0130		Radio Tashkent	7190.0as	9375.0as	9530.0as	9715.0as			
0100-0130		Swiss Radio Int'l	9885.0am	9905.0am					
0100-0130	s	Universal Life, Germany	9435.0as						
0100-0130		VOA	7115.0as	9635.0as	11705.0as	11725.0as	11820.0as	13650.0as	
			15250.0as	17740.0as	17820.0as				
0100-0130	twhfa	VOA	5995.0am	6130.0ca	7405.0am	9455.0af	9775.0am	13740.0am	
0100-0145		Deutsche Welle	6040.0am	9640.0am	11810.0na	13720.0na			
0100-0156		Radio Pyongyang	3560.0va	11735.0va	15229.9va	17734.9va			
0100-0200		Radio Australia	9660.0pa	12080.0pa	15240.0pa	15415.0as	17580.0pa	17750.0as	
			17795.0va	21725.0pa					
0100-0200		Radio Japan	9515.0me	11870.0me	11860.0as	15325.0as	15590.0as	17685.0pa	
			17835.0sa	17845.0as					
0100-0200		Voice of Indonesia	9525.0va	11784.9va	15149.8va				
0100-0200		Voice of Russia	9665.0na	11990.0na	12045.0na	15595.0na	17595.0na		
0100-0200		WYFR Okeechobee FL	6065.0na	9505.0na	15165.0as				
0100-0230		KJES Vado NM	7555.0na						
0100-0400		WWCR Nashville TN	3215.0na	5070.0na	5935.0na	7435.0na			
0100-0500		Radio Havana Cuba	6000.0na	9820.0na	11705.0uf				
0100-0800		NBC Windhoek, Namibia	3270.1af	3289.9af					
0100-1200		KALJ Dallas TX	5755.0va						
0100-1500		KTBN Salt Lake City UT	7510.0na						
0105-0110		Croatian Radio, Zagreb	9925.0na						
0130-0145		Voice of Africa, Libya	11815.0af	15415.0af	15435.0va				
0130-0159		Radio Canada Int'l	5960.0am	9755.0am					
0130-0159	sm	Radio Canada Int'l	11715.0am	13670.0am	15170.0am	15305.0am			
0130-0200		AWR Europe, Slovakia	11600.0as						
0130-0200		ORF Vienna	9655.0na	9870.0am	13730.0am				
0130-0200		Radio Sweden	13625.0as						
0130-0200		Radio Telefis Eireann	6155.0am						
0130-0200		VOA	7115.0as	9635.0as	11705.0as	11725.0as	11820.0as	13650.0as	
			15250.0as	17740.0as	17820.0as				
0130-0200	twhfa	VOA	5995.0am	6130.0ca	7405.0am	9455.0af			
0130-0200	twhfa	VOA Special English	7405.0am	9775.0am	13740.0am				
0140-0200		Vatican Radio	9650.0au	12055.0au					
0145-0200		Radio Tirana, Albania	6115.0na	7160.0na					
0200-0210		Radio Bangladesh	4882.0as						
0200-0210		Voice of Greece	7450.0va	9420.0va	12110.0va	15630.0va			
0200-0229		Radio Canada Int'l	9755.0am	11715.0am	13670.0am	15170.0am	15305.0am		
0200-0230	sm w fa	Radio Minsk, Belarus	7210.0af	11670.0pa					
0200-0230	a	Wales Radio Int'l	9795.0na						
0200-0245		Deutsche Welle	9615.0as	11945.0as	11965.0as				
0200-0256		Radio Pyongyang	11844.8va	13649.8va					
0200-0256		Radio Romania Int'l	9570.0na	11885.0as	11940.0na	15105.0as	15380.0pa	17790.0pa	
0200-0300		BBC World Service	5975.0na	6135.0am	6175.0na	6195.0eu	9410.0eu	9770.0af	
			9915.0sa	11760.0me	11955.0as	12095.0sa	15280.0as	15310.0as	
			15360.0as	17790.0as					
0200-0300		Radio Bulgaria	9400.0na	11700.0na					
0200-0300		Radio Korea	7275.0as	11725.0sa	11810.0sa	15575.0na			
0200-0300		Radio Myanmar	7185.0do						
0200-0300	twhfa	RAE Buenos Aires	11710.0am						
0200-0300		VOA	7115.0as	9635.0as	11705.0as	11725.0as	11820.0as	13650.0as	
			15250.0as	17740.0as	17820.0as				
0200-0300		Voice of Russia	9665.0na	11990.0na	13690.0na	15595.0na	17595.0na		
0200-0300		WSHB Cypress Creek SC	7535.0na	9430.0na					
0200-0330		Radio Cairo	9475.1am						
0200-0400		Radio Taipei Int'l	5950.0na	9680.0na	11740.0am	11825.0pa	15345.0as		
0200-0400		WRMI Miami FL	7385.0na						
0200-0400		WYFR Okeechobee FL	6065.0na	9505.0na					
0200-0430		Sri Lanka B'casting Corp.	6005.0as	6075.0as	6130.0do	9730.0as	15425.0as		
0200-0500		Radio Australia	9660.0pa	12080.0va	15240.0pa	15415.0as	15515.0va	17580.0pa	
			17750.0as	21725.0pa					
0200-1000		WEWN Birmingham AL	5825.0va						
0205-0210		Croatian Radio, Zagreb	9925.0ir						
0215-0220		Radio Nepal, Katmandu	5005.0as	7165.0as					
0230-0245		BBC English Teaching	15405.0as	17615.0as					
0230-0257		Voice of Vietnam	7250.0na	9695.0na					
0230-0300		Radio Budapest	9835.0na						
0230-0300		Radio Sweden	9495.0na						
0230-0300		Radio Tirana, Albania	6115.0na	7160.0na					
0245-0300		BBC English Teaching	9610.0af						
0250-0310		Vatican Radio	7305.0am	9605.0am					
0250-2210		Zambia Nat'l BC Corp.	6165.0do	6265.0do					
0300-0327		Radio Prague Int'l	7345.0na	7385.0na	11615.0na				
0300-0330		AWR Africa, Meyerton	6015.0af						
0300-0330		BBC World Service	3255.0af	5975.0na	6005.0af	6135.0am	6175.0na	6190.0af	
			6195.0eu	7120.0af	7160.0af	9410.0eu	11730.0af	11760.0me	
			11955.0as	12095.0af	15280.0as	15310.0as	15360.0as	17760.0as	
			17790.0as	21660.0as					
0300-0330		Channel Africa, S. Africa	6035.0af						
0300-0330	s twhfa	Radio Mexico Int'l	9705.0am						

0300-0330		Radio Thailand	9655.0am	11905.0am	15395.0na				
0300-0330		VOA	6080.0af	6115.0af	7105.0af	7275.0af	7290.0af	7340.0af	
			9575.0af	9885.0af	17725.0af				
0300-0330	sm twh	VOA	4960.0af						
0300-0345		Deutsche Welle	9535.0na	9640.0am	11810.0na	13780.0am	15105.0na		
0300-0356		China Radio Int'l	9690.0na						
0300-0400		Faro del Caribe, C. Rica	5054.6ca	6175.0ca	9644.7ca				
0300-0400		R. for Peace Int'l	6970.0va	15049.0va	25929.9uf				
0300-0400	sm	R. Luz y Vida, Honduras	3250.0ca						
0300-0400		Radio Iraq Int'l	7157.0ir	9684.0ir	11787.0ir				
0300-0400		Radio Japan	17825.0ca	21610.0pa					
0300-0400		Radio Sultanate Oman	15355.0va						
0300-0400		Radio Ukraine Int'l	6020.0eu	9640.0eu	12045.0eu				
0300-0400		Voice of Turkey	6155.0af	11655.0va	21715.0pa				
0300-0400		WSHB Cypress Creek SC	11930.0eu						
0300-0430		Radio Cultural, Guatemala	3300.0do	5955.0do					
0300-0500		Voice of Russia	7125.0na	9665.0na	11990.0na	15595.0na	17565.0na	17650.0na	
			17660.0na	17690.0na					
0300-0530		Zimbabwe BC Corp.	4828.0do	6045.0do					
0300-0600		KVOH Los Angeles CA	9975.0am						
0300-0600		Radio Botswana	3356.0do	4820.0do	7255.0do				
0300-0600		Radio Rwanda	6055.0do						
0300-0600		Radio Uganda	4976.0do	5026.0do					
0300-0600		Voice of Islam, Malaysia	6175.0as	9750.0as	15295.0as				
0300-0800	mtw hfa	WMLK Bethel PA	9465.0eu						
0300-1500		WRNO New Orleans LA	7395.0na						
0305-0310		Croatian Radio, Zagreb	9925.0na						
0310-0340		Vatican Radio	9660.0af						
0330-0345		Voice of Africa, Libya	11815.0af	15415.0af	15435.0va				
0330-0357		Radio Prague Int'l	11600.0as	15470.0as					
0330-0357		Voice of Vietnam	9795.0na	9830.0na					
0330-0400		BBC World Service	3255.0af	5975.0na	6005.0af	6135.0am	6175.0na	6190.0af	
			6195.0eu	7120.0af	7160.0af	9410.0eu	11730.0af	11760.0as	
			11955.0as	12095.0af	15280.0as	15310.0as	15420.0af	17660.0as	
			17790.0as	21660.0as					
0330-0400	m	La Voz Evangelica, Hond.	4819.2do						
0330-0400		Radio Dubai, UAE	12005.0na	13675.0na	15400.0na				
0330-0400		Radio Sweden	9495.0na						
0330-0400		VOA	6080.0af	6115.0af	7105.0af	7275.0af	7290.0af	9575.0af	
			9885.0af	17725.0af					
0345-0400	f	FEBE Seychelles	11885.0af						
0400-0405		WWCR Nashville TN	5070.0na	5935.0na	7435.0na				
0400-0405	sm	WWCR Nashville TN	3210.0na						
0400-0405	tw hfa	WWCR Nashville TN	3215.0na						
0400-0415		Kol Israel	9435.0va	15640.0va	17535.0va				
0400-0426		R. Viaanderen Int'l	15565.0na						
0400-0429		Radio Canada Int'l	11835.0me	11975.0me	15215.0me				
0400-0429	mtw h f	Radio Canada Int'l	13765.0af	15345.0af					
0400-0430		Channel Africa, S. Africa	5955.0af						
0400-0430		Radio Cultural, Guatemala	3300.0do	5955.0do					
0400-0430	tw hfa	Radio Mexico Int'l	9705.0am						
0400-0430		Radio Nigeria, Kaduna	6090.0do	7275.0do					
0400-0430		Swiss Radio Int'l	9610.0eu	9885.0am	9905.0am				
0400-0430		VOA	6080.0af	7170.0va	7265.0af	7275.0af	7290.0af	9575.0af	
			9885.0af	11965.0me	15205.0va	17725.0af			
0400-0445		Deutsche Welle	7225.0af	9565.0af	9765.0af	13690.0af			
0400-0445		WYFR Okeechobee FL	6065.0na	9505.0na	9985.0eu				
0400-0456		China Radio Int'l	9730.0na						
0400-0456		Radio Romania Int'l	11940.0na	15105.0na	15335.0as	17745.0as			
0400-0500		BBC World Service	3255.0af	5975.0na	6005.0af	6135.0am	6175.0na	6190.0af	
			6195.0eu	7120.0af	7160.0af	9410.0eu	11760.0me	12095.0eu	
			15280.0as	15310.0as	15420.0af	15575.0me	17640.0af	17760.0as	
			17790.0as	21660.0as	21830.0as				
0400-0500		KWHR Naalehu HI	17780.0as						
0400-0500	s tw hfa	WRMI Miami FL	7385.0na						
0400-0500	m	WRMI Miami FL	9955.0am						
0400-0500		WSHB Cypress Creek SC	11930.0eu	15195.0af					
0400-0600		Christian Voice, Zambia	6065.0do						
0400-1200		R. for Peace Int'l	6970.0va	15049.0ir					
0400-2305		Radio Nigeria, Enugu	6025.0do						
0400-2400		Cameroon Radio-TV	4850.0do						
0405-0410		Croatian Radio, Zagreb	9925.0ir						
0405-0500		WWCR Nashville TN	3210.0na	5070.0na	5935.0na	7435.0na			
0425-0440		RAI, Rome	5975.0af	7150.0af					
0430-0445		BBC English Teaching	6010.0eu	9915.0eu					
0430-0500		ORF Vienna	6155.0eu	13730.0eu					
0430-0500		Radio Yugoslavia	9580.0na						
0430-0500		Swiss Radio Int'l	9885.0am	9905.0am					
0430-0500		TWR Swaziland	3200.0af	4775.0af					
0430-0500		VOA	6080.0af	7170.0va	7265.0af	7275.0af	7290.0af	9575.0af	
			11965.0me	15205.0va	17725.0af				
0430-0530		Radio Netherlands	6165.0na	9590.0na					
0430-0600		Italian Radio Relay Svc	3985.0va						
0430-0630		African Beacon	6115.0af						
0430-1000		Radio Nigeria, Lagos	3326.0do	4990.0do					
0430-1000		Sri Lanka Broadcasting Corp.	6130.0do						

0430-2305		Radio Nigeria, Ibadan	6050.0do						
0430-2305		Radio Nigeria, Kaduna	4770.0do	6090.0do	7275.0do	9570.0do			
0445-0500		WYFR Okeechobee FL	9985.0eu						
0500-0504		Radio Pakistan	15175.2me	17834.9me	21465.2me				
0500-0520		Vatican Radio	4005.0eu	5883.0eu	7250.0eu	9660.0af	11625.0af	15570.0af	
0500-0529		Radio Canada Int'l	5995.0am	6145.0va	7290.0va	9595.0va	9755.0am	11710.0va	
			11830.0am	13755.0va	15330.0va				
0500-0530		AWR Africa, Meyerton	5960.0af	6015.0af					
0500-0530		BBC World Service	3255.0af	5975.0na	6005.0af	6175.0am	6190.0af	6195.0eu	
			7160.0af	9410.0eu	9740.0as	11760.0me	11765.0af	11955.0pa	
			12095.0eu	15280.0as	15310.0as	15360.0as	15420.0af	15575.0me	
			17640.0af	17760.0as	17790.0as	17885.0af	21660.0as		
0500-0530		Channel Africa, S. Africa	11720.0af						
0500-0530		Swiss Radio Int'l	9610.0eu						
0500-0530		WRMI Miami FL	7385.0na						
0500-0545		Deutsche Welle	9670.0na	9785.0na	11810.0na	11985.0na			
0500-0556		China Radio Int'l	9560.0na						
0500-0600		Radio Australia	9660.0pa	12080.0va	15240.0pa	15515.0va	17580.0pa	21725.0pa	
0500-0600	s	Radio Australia	17750.0as						
0500-0600		Radio Exterior de Espana	6055.0na						
0500-0600		Radio Japan	5975.0eu	6110.0na	7230.0eu	11715.0as	11760.0as	11840.0as	
			13630.0na	15590.0as	21570.0pa				
0500-0600		VOA	5970.0af	6035.0af	6080.0af	7170.0va	7195.0af	9530.0	
			11965.0me	12080.0af	13670.0af	15205.0va			
0500-0600		Voice of Russia	17625.0au	17665.0au	21790.0au				
0500-0600		WSHB Cypress Creek SC	7535.0eu	9840.0af					
0500-0600		WYFR Okeechobee FL	5985.0na	9985.0eu	11580.0eu				
0500-0700		Radio Havana Cuba	9550.0na	9820.0na	9830.0uf				
0500-0700		Voice of Nigeria	7255.0af	15120.0af					
0500-0720		TWR Swaziland	4775.0af	6100.0af	9500.0af				
0500-0800		Radio Kuwait	15110.0as	15230.0as					
0500-0800		SIBC Solomon Islands	5020.0do	9545.0do					
0500-0900		WWCR Nashville TN	2390.0na	3210.0na	5070.0na	5935.0na			
0500-1000		KWHR Naalehu HI	11565.0pa	17780.0as					
0500-1000		Radio Kiribati	9809.9do	9825.0do					
0500-1000		Radio Liberia Int'l	5100.0do						
0500-1000		WHRA Greenbush ME	11565.0af						
0505-0510		Croatian Radio, Zagreb	9470.0au	11970.0af					
0520-0530		Vatican Radio	9660.0af	11625.0af	15570.0af				
0525-0915		Ghana Broadcasting Corp.	3366.0do	4915.0do					
0530-0545	s	BBC English Teaching	9875.0eu	11770.0eu					
0530-0545		BBC World Service	3255.0af	5975.0na	6005.0af	6175.0am	6190.0af	6195.0eu	
			7160.0af	9410.0eu	9740.0as	11760.0me	11765.0af	11955.0pa	
			12095.0eu	15310.0as	15360.0as	15420.0af	15575.0as	17640.0af	
			17760.0as	17790.0as	17885.0af	21660.0as			
0530-0600		Georgian Radio, Tbilisi	11805.0eu						
0530-0600		ORF Vienna	6015.0na						
0530-0600		Radio Dubai, UAE	13675.0au	15435.0au	17830.0au	21700.0au			
0530-0600		Radio Thailand	9655.0eu	11905.0eu	15445.0eu				
0530-0600	mtwhfa	WRMI Miami FL	7385.0na						
0530-1630		Zimbabwe BC Corp.	5975.0do	6045.0do					
0545-0600		BBC English Teaching	9710.0af	9760.0eu	12045.0af				
0545-0600		BBC World Service	3255.0af	5975.0na	6005.0af	6175.0am	6190.0af	6195.0eu	
			7160.0af	9410.0eu	9740.0as	11760.0me	11765.0af	11955.0pa	
			12095.0eu	15310.0as	15360.0as	15420.0af	15575.0as	17640.0af	
			17760.0as	17790.0as	17885.0af	21660.0as			
0545-0600	s	BBC World Service	11675.0eu						
0600-0615		TWR Meyerton	11640.0af						
0600-0615		WBCQ Monticello ME	7415.0na						
0600-0629	mtwhf	Radio Canada Int'l	11715.0af	13755.0af	15330.0af	17820.0af			
0600-0630		BBC World Service	6005.0af	6175.0am	6190.0af	6195.0eu	7160.0af	9410.0eu	
			9580.0va	9740.0as	11760.0me	11765.0af	11940.0af	11955.0pa	
			12095.0eu	15310.0as	15360.0as	15420.0af	15485.0eu	15565.0eu	
			15575.0as	17640.0af	17760.0as	17790.0as	17885.0af	21660.0as	
0600-0630	mtwhfa	Channel Africa, S. Africa	15215.0af						
0600-0630		V. of the Mediterranean	7150.0eu						
0600-0630		VOA	5970.0af	6035.0af	6080.0af	7170.0va	7195.0af	9680.0af	
			11805.0af	11965.0me	11995.0af	12080.0af	13670.0af	15205.0va	
0600-0641		Radio Romania Int'l	11940.0na	15335.0na					
0600-0645		Deutsche Welle	6140.0eu	13790.0af	15275.0af	17860.0af			
0600-0700		HCBJ Quito Ecuador	9745.0na	15115.0na	15160.0eu	21455.0uf			
0600-0700	mtwhf	Italian Radio Relay Svc	7120.0va						
0600-0700		Overcomer Ministries	13810.0au						
0600-0700		Radio Australia	9660.0pa	12080.0va	15240.0pa	15415.0as	15515.0va	17580.0pa	
			17750.0as	21725.0pa					
0600-0700		Radio Japan	5975.0eu	7230.0eu	11740.0as	11840.0as	13630.0na	15230.0pa	
			21570.0pa						
0600-0700		Republic of Yemen Radio	9780.0me						
0600-0700		Voice of Malaysia	6175.0as	9750.0as	15295.0as				
0600-0700		Voice of Russia	15490.0au	17625.0au	17655.0as	17665.0au	21790.0au		
0600-0700	twhfa	WGTC McCaysville GA	5085.0uf	6890.0uf					
0600-0700	twhfa	WRMI Miami FL	7385.0na						
0600-0700		WYFR Okeechobee FL	5985.0na	7355.0eu					
0600-0800		WSHB Cypress Creek SC	13650.0af						
0600-1000		SLBS, Sierra Leone	3316.0do						
0600-1300		Radio Uganda	5026.0do	7110.0do	7196.0do				

0804-0820		Radio Pakistan	17834.9eu	21465.2eu					
0805-0810		Croatian Radio, Zagreb	13820.Oau						
0815-0900		FEBA Seychelles	15460.Oas						
0820-0850	s	TWR Monte Carlo	6045.Oeu	9870.Oeu					
0830-0900		Georgian Radio, Tbilisi	11910.Ome						
0830-0900		ORF Vienna	21650.Oas	21765.Oau					
0830-0900		Swiss Radio Int'l	9885.Oau	13685.Oau					
0830-2130		ABC Alice Springs	2310.Odo						
0830-2130		ABC Katherine	2485.Odo						
0830-2130		ABC Tennant Creek	2325.Odo						
0840-0900	s	Voice of Armenia, Yerevan	4810.Oeu	15270.Oeu					
0900-0929		Radio Prague Int'l	21745.Ova						
0900-0930		BBC World Service	6190.Oaf	6195.Oas	9605.Oas	9740.Oas	11760.Ome	11765.Oas	
			11940.Oaf	11955.Opa	12095.Oeu	15190.Osa	15310.Oas	15360.Oas	
			15400.Oaf	15485.Oeu	15565.Oeu	15575.Oas	17640.Oeu	17760.Oas	
			17790.Oas	17830.Oaf	17885.Oaf	21470.Oaf	21660.Oas		
0900-0930	mtwhfa	BBC World Service	11945.Oas						
0900-0945		Deutsche Welle	6140.Oeu	6160.Opa	9565.Oaf	15105.Oas	15210.Oaf	15410.Oaf	
			15470.Oas	17560.Oas	17800.Oaf	21560.Oas	21680.Oas	21790.Oaf	
0900-0956		China Radio Int'l	11730.Opa	15210.Opa					
0900-1000	s	Good News World Radio	13740.Oau						
0900-1000	a	Good News World Radio	5985.Oeu	5995.Oeu					
0900-1000	s	Merlin Network One	6130.Oeu						
0900-1000		VDA	11775.Oas	11930.Oas	13610.Oas	15150.Oas			
0900-1000		WSHB Cypress Creek SC	9455.Osa	9860.Oeu					
0900-1000		WWCR Nashville TN	2390.Ona	5070.Ona	5935.Ona	7435.Ona			
0900-1100		Radio Australia	13605.Opa	21820.Oas					
0915-0930		KTWR Guam	15330.Oas						
0915-1000	mtwhf	WRMI Miami FL	9955.Oam						
0915-1200		Ghana Broadcasting Corp.	6130.Odo						
0915-1200	s	Ghana Broadcasting Corp.	4915.Odo						
0930-1000		AWR Europe, Forli	9610.Oeu	13790.Oal					
0930-1000		BBC English Teaching	9605.Oas	11765.Oas					
0930-1000		BBC World Service	6190.Oaf	6195.Oas	9740.Oas	11760.Ome	11940.Oaf	11945.Oas	
			11955.Opa	12095.Oeu	15190.Osa	15310.Oas	15360.Oas	15400.Oaf	
			15485.Oeu	15565.Oeu	15575.Oas	17640.Oeu	17760.Oas	17790.Oas	
			17830.Oaf	17885.Oaf	21470.Oaf	21660.Oas			
0930-1000		Radio Vilnius, Lithuania	9710.Oeu						
0930-1030		Radio Netherlands	9795.Oas	12065.Oas	13710.Oas				
0930-1100		KTWR Guam	9865.Oas						
0945-1100		Deutsche Welle	6140.Oeu						
1000-1027		Voice of Vietnam	9839.9as	12019.5as					
1000-1030		BBC World Service	5965.Ona	6190.Oaf	6195.Ova	9740.Oas	11760.Ome	11940.Oaf	
			11955.Opa	12095.Oeu	15310.Oas	15360.Oas	15485.Oeu	15565.Oeu	
			15575.Oas	17640.Oeu	17760.Oas	17790.Oas	17885.Oaf	21470.Oaf	
			21660.Oas						
1000-1030	s	BBC World Service	15190.Osa	15400.Oaf	17830.Oaf				
1000-1030		KSDA Guam	11560.Oas						
1000-1030		Radio Telefis Eireann	11740.Oau						
1000-1030		Sri Lanka B'casting Corp.	4940.Odo						
1000-1030		Swiss Radio Int'l	15315.Oeu						
1000-1056		China Radio Int'l	11730.Opa	15210.Opa					
1000-1100		All India Radio, Delhi	11585.Oas	13700.Oau	15020.Oas	17485.Oau	17840.Oas	17895.Oau	
1000-1100	s	BBS, Bhutan	6035.Odo						
1000-1100		Radio Japan	9695.Oas	15590.Oas	21570.Opa				
1000-1100		VDA	6165.Oca	7405.Oca	9590.Oca	9770.Opa	15240.Oas	15425.Oas	
1000-1100		Voice of Nigeria	7255.Oaf	15120.Oaf					
1000-1100		WSHB Cypress Creek SC	6095.Oam	9455.Osa					
1000-1100		WWCR Nashville TN	5070.Ona	5935.Ona	7435.Ona	9475.Ona			
1000-1100		WYFR Okeechobee FL	5950.Ona						
1000-1130	mtwhfa	WRMI Miami FL	9955.Oam						
1000-1200		KHBI Saipan, Marianas	11840.Oas						
1000-1200		Radio Jordan	17680.Ova						
2000-1300		WHRI Noblesville IN	6040.Ona	9495.Osa					
1000-1600		KWHR Naalehu HI	9930.Oas	11565.Opa					
1000-1600		Radio Nigeria, Lagos	4990.Odo	7285.Odo					
1000-1600		WEWN Birmingham AL	7425.Ona	15745.Oeu					
1000-1800		Radio Liberia Int'l	6100.Odo						
1000-1900		SLBS, Sierra Leone	5980.Odo						
1000-2000		ZLXA New Zealand	3935.Odo						
1000-2200		Caribbean Beacon	11775.Oam						
1000-2200		Voice of Guyana	5949.4do						
1015-1030		BBC English Teaching	11805.Oeu	13630.Oeu	15325.Oeu	15340.Oeu	17695.Oeu		
1015-1030	mtwh	BBC English Teaching	9410.Oeu	11970.Oeu					
1015-1030	mtwhf	Vatican Radio	5883.Oeu	9645.Oeu	11740.Oeu	15595.Oeu	21850.Oeu		
1030-1035		Kol Israel	15640.Ova	17535.Ova					
1030-1045	mtwhf	Radio Ethiopia	5990.Odo	7110.Odo	9704.2do				
1030-1057		Radio Prague Int'l	9880.Oeu	11615.Oeu					
1030-1100		BBC World Service	5965.Ona	6190.Oaf	6195.Ova	9740.Oas	11760.Ome	11940.Oaf	
			11955.Opa	12095.Oeu	15310.Oas	15485.Oeu	15565.Oeu	15575.Oas	
			17640.Oeu	17790.Oas	17885.Oaf	21470.Oaf			
1030-1100	s	BBC World Service	15190.Osa	15400.Oaf	17830.Oaf				
1030-1100		KSDA Guam	11560.Oas	11795.Oas					
1030-1100		Radio Dubai, UAE	13675.Oeu	15370.Oeu	15395.Oeu	21605.Oeu			

1030-1100		Radio Korea	11715.0na						
1030-1100		Voice of Mongolia	12085.0au						
1030-1130		Radio Netherlands	6045.0eu	9795.0as	9860.0eu	12065.0as	13710.0as		
1030-1130		Sri Lanka B'casting Corp.	4940.0do	11835.0as	15120.0as	17850.0as			
1100-1104		Radio Pakistan	7110.0do	17834.9eu	21465.2eu				
1100-1120		fa Radio Almaty, Kazakhstan	9620.0eu	11840.0eu					
1100-1125		Radio Moldova Int'l	11580.0am						
1100-1127		Voice of Vietnam	7285.0as						
1100-1130	mtwhf	BBC Caribbean Report	6195.0ca	15220.0ca					
1100-1130		BBC World Service	5965.0na	6195.0as	9580.0as	9740.0as	11760.0me	11955.0as	
			12095.0eu	15280.0as	15310.0as	15400.0af	15485.0eu	15565.0eu	
			15575.0as	17640.0eu	17700.0as	17790.0sa	17830.0af	17885.0af	
			21470.0af						
1100-1130	mtwhfa	BBC World Service	6190.0af	11940.0af					
1100-1130	s	a BBC World Service	6195.0na	15190.0as	15220.0am				
1100-1130		VOA	6160.0as	9645.0as	9760.0as	9770.0pa	15160.0as	15240.0as	
			15425.0as						
1100-1130	mtwhf	VOA	13675.0af	15550.0af	17650.0af	17780.0af	21600.0af		
1100-1145		Deutsche Welle	6140.0eu	11785.0af	15410.0af	17680.0af	17860.0af		
1100-1200		FEBC Manila	11580.0as						
1100-1200		Radio Bulgaria	15700.0eu	17500.0eu					
1100-1200	mtwhf	Radio Canada Int'l	9640.0na	13650.0na	17765.0na	17820.0na			
1100-1200		Radio Japan	6120.0na	9695.0as	15590.0as				
1100-1200		Radio Ukraine Int'l	21520.0au						
1100-1200		Swiss Radio Int'l	13735.0as	21770.0as					
1100-1200		Voice of Asia, Taiwan	7445.0as						
1100-1200		WWCR Nashville TN	5070.0na	5935.0na	7435.0na	15685.0na			
1100-1200		WYFR Okeechobee FL	5850.0na	5950.0na					
1100-1215	s	Radio Vanuatu	3945.0do	4960.0do	7260.0do				
1100-1230		VOIRI Teheran	15385.0as	15430.0as	15585.0as	21470.0as	21730.0as		
1100-1300		Overcomer Ministries	5850.0eu						
1100-1300		WSHB Cypress Creek SC	6095.0am	11660.0am					
1100-1330		Radio Australia	5995.0pa	6020.0pa	9580.0va	13605.0pa	21820.0as		
1100-1400		Radio Singapore Int'l	6150.0as	9590.0as					
1100-1530		HCJB Quito Ecuador	12005.0am	15115.0am	21455.0uf				
1100-1600		KHBN Palau	9955.0as	9965.0as	9985.0as	13840.0as			
1100-2400		CBC Northern Service	9625.0do						
1115-1145		Radio Nepal, Katmandu	5005.0as	7165.0as					
1120-1140	w	Radio Almaty, Kazakhstan	9620.0eu	11840.0eu					
1130-1145		Voice of Africa, Libya	11815.0af	15415.0af	15435.0va				
1130-1156		R. Vlaanderen Int'l	9865.0as	9925.0eu					
1130-1157		Radio Prague Int'l	6055.0eu	21745.0as					
1130-1200		BBC English Teaching	5875.0eu	9410.0eu	9635.0eu	11680.0eu	11895.0eu	13670.0eu	
			15260.0eu	15325.0eu	17695.0eu				
1130-1200		BBC World Service	5965.0na	6195.0va	9580.0as	9740.0as	11760.0me	11955.0as	
			12095.0eu	15220.0am	15280.0as	15310.0as	15485.0eu	15565.0eu	
			15575.0as	17640.0eu	17700.0as	17830.0af	17885.0af	21470.0af	
			6190.0af	11940.0af					
1130-1200	mtwhfa	BBC World Service	18960.0na						
1130-1200		Radio Sweden	17590.0as	17795.0as					
1130-1200	f	University Network	15595.0va	17515.0va					
1130-1200		Vatican Radio	6160.0as	9645.0as	9760.0as	9770.0pa	15160.0as	15240.0as	
1130-1200		VOA	15425.0as						
1130-1230		Radio Netherlands	6045.0eu	9860.0eu					
1130-1230		Sri Lanka B'casting Corp.	4940.0do						
1130-1300		WRMI Miami FL	9955.0am						
1140-1200	t	Radio Almaty, Kazakhstan	9620.0eu	11840.0eu					
1145-1600		Deutsche Welle	6140.0eu						
1200-1215		BBC English Teaching	7135.0as	11835.0as					
1200-1215		V. of Cambodia	11940.3as						
1200-1220	mtwhf	BBC Caribbean Report	6195.0ca	15220.0ca					
1200-1220		BBC World Service	5965.0na	6190.0af	6195.0as	9515.0na	9580.0as	9740.0as	
			11760.0me	11940.0af	11955.0as	12095.0eu	15280.0as	15310.0as	
			15485.0eu	15565.0eu	15575.0me	17640.0eu	17700.0as	17830.0af	
			17885.0af	21470.0af					
1200-1220	s	a BBC World Service	6195.0na	15220.0am					
1200-1230		Radio Canada Int'l	9640.0na	9660.0as	13650.0na	15195.0as	17765.0na	17820.0na	
1200-1230		Radio Tashkent	7285.0as	9715.0as	15295.0as	17775.0as			
1200-1230		Swiss Radio Int'l	15315.0eu						
1200-1230		VOA	6160.0as	9645.0as	9760.0as	15160.0as	15240.0as	15425.0as	
1200-1245		WYFR Okeechobee FL	5850.0na	5950.0na	17750.0na				
1200-1255		Radio Polonia, Warsaw	6095.0eu	7270.0eu	9525.0eu	11820.0eu			
1200-1256		China Radio Int'l	9715.0as	9760.0pa	11675.0pa	11980.0as	15415.0as		
1200-1256		Radio Pyongyang	3560.0va	9640.0va	9850.0va	9975.0va	11335.0va	13650.1va	
1200-1300	mtwhf	BBS, Bhutan	5030.0do						
1200-1300		KHBI Saipan, Marianas	11550.0as						
1200-1300		Radio France Int'l	11670.0eu	15155.0eu	15195.0eu	15540.0af			
1200-1300		Radio Taipei Int'l	7130.0as	9610.0au					
1200-1300		WWCR Nashville TN	5070.0na	7435.0na	13845.0na	15685.0na			
1200-1400	mtwhf	WGTG McCaysville GA	9400.0va	12172.0uf					
1200-1600		University Network	17795.0as						
1200-1630		Radio Jordan	11690.0va						
1200-1700		Ghana Broadcasting Corp.	4915.0do	6130.0do					
1200-2400		KALJ Dallas TX	13815.0va						
1200-2400		R. for Peace Int'l	15049.0ir	25929.0uf					
1205-1210		Croatian Radio, Zagreb	7185.0eu	7365.0eu	8165.0eu	9830.0eu			

1205-1505		Radio New Zealand Int'l	6100.00c						
1215-1330		Radio Cairo	17595.0as						
1220-1300		BBC World Service	5965.0na	6190.0af	6195.0va	9515.0na	9580.0as	9740.0as	
			11760.0me	11940.0af	11955.0as	12095.0eu	15280.0as	15310.0as	
			15485.0eu	15565.0eu	15575.0me	17640.0eu	17700.0as	17830.0af	
			17885.0af	21470.0af					
1220-1300	mtwhf	BBC World Service	15220.0am						
1230-1245		BBC English Teaching	15105.0af	17780.0af	21640.0af				
1230-1257		Voice of Vietnam	9839.9as	12019.5as					
1230-1259		Radio Canada Int'l	9640.0na	13650.0na	17765.0na	17820.0na			
1230-1300		AWR Europe, Forli	9610.0cu	13790.0al					
1230-1300		KSDA Guam	15330.0as						
1230-1300		ORF Vienna	6155.0eu	13730.0va					
1230-1300		Radio Bangladesh	7184.0as	9558.0as					
1230-1300		Radio Sweden	18960.0na	21810.0as					
1230-1300		Radio Thailand	9655.0as	9885.0as	11905.0as				
1230-1300		VOA	6160.0as	9645.0as	9760.0as	15160.0as	15240.0as	15425.0as	
1230-1300		a Wales Radio Int'l	17650.0au						
1230-1330		Voice of Turkey	17830.0eu	21540.0va					
1230-1600		Sri Lanka B'casting Corp.	4940.0do	6005.0as	6075.0as	9730.0as	15425.0as		
1245-1300		a FEBA Seychelles	15535.0me						
1300-1315	smtwhf	WRMI Miami FL	9955.0am						
1300-1329		Radio Prague Int'l	13580.0eu	17485.0as					
1300-1330	smtwhf	Radio Canada Int'l	13650.0na						
1300-1330	s	Radio Canada Int'l	17800.0na						
1300-1330	mtwhf	Radio Canada Int'l	9640.0na	17765.0na	17820.0na				
1300-1330	s	Universal Life, Germany	9955.0na						
1300-1356		China Radio Int'l	7405.0na	9570.0na	11675.0pa	11900.0pa	11980.0as	15180.0as	
1300-1356		Radio Romania Int'l	15250.0na	15390.0eu	17770.0eu	17790.0na			
1300-1400		BBC World Service	5965.0na	5990.0as	6190.0af	6195.0va	9515.0na	9740.0as	
			11760.0me	11865.0na	11940.0af	12095.0eu	15220.0am	15310.0as	
			15420.0af	15485.0eu	15565.0eu	15575.0me	17640.0eu	17700.0as	
			17830.0af	17885.0af	21470.0af				
1300-1400	s	Good News World Radio	15330.0as						
1300-1400		KHBI Saipan, Marianas	9940.0as						
1300-1400		KNLS Anchor Point AK	9615.0as						
1300-1400		Radio Korea	9570.0as	9640.0om	13670.0as				
1300-1400		SIBC Solomon Islands	5020.0do						
1300-1400		VOA	6160.0as	9645.0as	9760.0as	15160.0as	15425.0as		
1300-1400		WSHB Cypress Creek SC	9430.0am	9455.0na					
1300-1500	s	a Channel Africa, S. Africa	11720.0af	17780.0af	21725.0af				
1300-1500		FEBC Manila	11995.0as						
1300-1500		KJES Vado NM	11715.0na						
1300-1500		Overcomer Ministries	5850.0eu	13810.0eu					
1300-1500		WHRI Noblesville IN	6040.0na	15105.0sa					
1300-1500		WYFR Okeechobee FL	11550.0as	11830.0na	11970.0na	17750.0na			
1300-1600		Voice of Hope, Lebanon	11530.0va						
1300-1700		a Global Sound Kitchen	9750.0eu	12005.0eu	15235.0eu				
1300-1900		Nat'l BC, Papua NG	3395.0do						
1300-2100		Radio Uganda	4976.0do	5026.0do					
1300-2200		WOCR Nashville TN	9475.0na	12160.0na	13845.0na	15685.0na			
1315-1700	s	WRMI Miami FL	9955.0am						
1330-1345		BBC English Teaching	15105.0af	21640.0af					
1330-1357		Voice of Vietnam	7145.0eu	9730.0eu					
1330-1400		KSDA Guam	11705.0as	11750.0as					
1330-1400		Radio Australia	5995.0pa	6020.0pa	9475.0as	9580.0va	11650.0pa	21820.0as	
1330-1400		Radio Canada Int'l	9535.0as	11795.0as					
1330-1400	smtwhf	Radio Canada Int'l	13650.0na						
1330-1400	s	Radio Canada Int'l	17800.0na						
1330-1400	mtwhf	Radio Canada Int'l	9640.0na	17765.0na	17820.0na				
1330-1400		Radio Dubai, UAE	13675.0eu	15395.0eu	21605.0eu				
1330-1400		Radio Sweden	17900.0as	18960.0na					
1330-1400		Radio Tashkent	7285.0as	9715.0as	15295.0as	17775.0as			
1330-1500		All India Radio, Delhi	9710.0as	11620.0as	13710.0as				
1330-1630		Voice of Hope, Germany	15715.0as	17550.0af					
1330-2400		Kenya BC Corp	4885.0do	4915.0do	4935.0do				
1345-1405		Vatican Radio	17515.0au	21620.0au					
1400-1430		Kol Israel	15650.0va	17535.0va					
1400-1430		Radio Australia	5995.0as	9475.0as	9580.0va	11650.0pa			
1400-1430		Radio Mexico Int'l	5985.0am	9705.0am					
1400-1430		Radio Thailand	9655.0as	9830.0as	11905.0as				
1400-1430	s	Universal Life, Germany	9710.0eu						
1400-1430		VOA	6160.0as	7125.0as	9645.0as	9760.0as	15160.0as	15255.0va	
			15425.0as						
1400-1430	s	VOA	18275.0lf	18275.0uf					
1400-1456		China Radio Int'l	7405.0na	9700.0as	11675.0as	11825.0as	13685.0af	15110.0as	
			15125.0af						
1400-1500		BBC World Service	5990.0as	6190.0af	6195.0as	9515.0na	9740.0as	11865.0na	
			11940.0af	12095.0eu	15220.0na	15310.0as	15485.0eu	15565.0eu	
			15575.0me	17640.0eu	17700.0as	17830.0af	17840.0am	21470.0af	
			21660.0af						
1400-1500		Radio France Int'l	11610.0as	17620.0va	17680.0as				
1400-1500		Radio Japan	9505.0na	9860.0as	11730.0as	11880.0me			
1400-1500		Radio Sultanate Oman	15140.0eu						
1400-1500		Radio Tahiti Int'l	14175.0as						

1400-1500		Swiss Radio Int'l	9575.0as	17670.0as						
1400-1500		Voice of Russia	11695.0as	12025.0as	12055.0me					
1400-1559	s	Radio Canada Int'l	13650.0na	17800.0na						
1400-1600		SBC Radio 1, Singapore	6150.0do							
1400-2200		WGTC McCaysville GA	12172.0uf							
1400-2200	mtwhf	WGTC McCaysville GA	9400.0va							
1415-1420		Radio Nepal, Katmandu	5005.0as	7165.0as						
1415-1430	mtw	BBC English Teaching	11860.0af	15420.0af	21490.0af					
1430-1500		AWR Europe, Slovakia	17525.0as							
1430-1500		KSDA Guam	9385.0as							
1430-1500		VOA	6160.0as	7125.0as	9645.0as	9760.0as	15160.0as	15255.0va		
			15425.0as							
1430-1600		KTWR Guam	15330.0as							
1430-1600		Radio Myanmar	5985.9do							
1430-1630		Radio Netherlands	9890.0as	12065.0as	15590.0as					
1430-1700		Radio Australia	5995.0as	9475.0as	9580.0va	11650.0pa	11660.0as			
1500-1515		Voice of Shariah, Afghan.	7002.2do	7085.0do						
1500-1530		BBC World Service	5975.0as	5990.0as	6190.0af	6195.0as	9515.0na	9740.0as		
			11860.0af	11865.0na	11940.0af	12095.0eu	15220.0na	15310.0as		
			15400.0af	15420.0af	15485.0eu	15575.0eu	17700.0as	17830.0af		
			17840.0am	21470.0af	21490.0af	21660.0af				
1500-1530		Channel Africa, S. Africa	17770.0af							
1500-1530		ORF Vienna	17865.0na							
1500-1530		Radio Mexico Int'l	5985.0am	9705.0am						
1500-1530		VOA	7125.0as	9645.0as	9700.0me	9780.0as	15205.0va	15255.0va		
1500-1530		VOA Special English	6160.0as	9590.0as	9760.0as	9845.0as	12040.0as	15235.0as		
1500-1530		Voice of Mongolia	12015.0as	12085.0as						
1500-1556		China Radio Int'l	7160.0as	7405.0na	9785.0as	13685.0af	15125.0af			
1500-1556		Radio Pyongyang	4405.0va	6574.9na	9335.2na	11710.0na	13760.1na			
1500-1600		FEBA Seychelles	11600.0as							
1500-1600		Overcomer Ministries	5850.0eu							
1500-1600		Radio Japan	9750.0as	9860.0as	11730.0as					
1500-1600		Voice of Russia	4940.0me	4965.0me	4975.0me	7325.0me	9730.0eu	11500.0as		
			12015.0me							
1500-1600		WYFR Okeechobee FL	11830.0na	17750.0na						
1500-1700		Voice of Nigeria	7255.0af	15120.0af						
1500-1700		WHRI Noblesville IN	13760.0na	15105.0sa						
1500-2200		Christian Voice, Zambia	4965.0do							
1500-2200		WHRA Greenbush ME	17650.0af							
1500-2400		KTBN Salt Lake City UT	15590.0na							
1500-2400		WRNO New Orleans LA	7395.0na	15420.0al						
1505-1650		Radio New Zealand Int'l	6145.0oc							
1530-1545		BBC English Teaching	11685.0as	15540.0as						
1530-1545		Radio Bangladesh	4882.0as	15520.0as						
1530-1600		BBC World Service	5975.0as	5990.0as	6190.0af	6195.0as	9515.0na	9740.0as		
			11865.0na	11940.0af	12095.0eu	15220.0na	15310.0as	15400.0af		
			15485.0eu	15575.0eu	17700.0as	17830.0af	17840.0am	21470.0af		
			21660.0af							
1530-1600		Georgian Radio, Tbilisi	6180.0me							
1530-1600		VOA	7125.0as	9645.0as	9700.0me	9780.0as	15205.0va	15255.0va		
1530-1600		VOA Special English	6160.0as	9590.0as	9760.0as	9845.0as	12040.0as	15235.0as		
1530-1630		HCBJ Quito Ecuador	12005.0am	15115.0am						
1530-1630		VOIRI Teheran	7115.0as	9635.0as	11775.0as					
1530-1800		Radio Botswana	3356.0do	4820.0do	7255.0do					
1545-1610	s	Radio Bangladesh	4882.0as	15520.0as						
1550-1610	h	Vatican Radio	12065.0au	13765.0au	17730.0au					
1600-1615		BBC World Service	3915.0as	5975.0as	6190.0af	6195.0as	7160.0as	9515.0na		
			9740.0as	11940.0af	12095.0eu	15310.0as	15400.0af	15485.0eu		
			15575.0eu	17700.0as	17830.0af	17840.0am	21470.0af	21660.0af		
1600-1615		Radio Pakistan	11570.1me	15100.2af	15334.9af	17510.0me	17720.0af			
1600-1627		Radio Prague Int'l	5930.0eu	21745.0af						
1600-1630		Channel Africa, S. Africa	9525.0af							
1600-1630	s	a KTWR Guam	15330.0as							
1600-1630		Radio Dubai, UAE	13675.0eu	15395.0eu	21605.0eu					
1600-1630	s	Universal Life, Germany	15105.0af							
1600-1645		Deutsche Welle	6140.0eu	6170.0as	7225.0as	9735.0af	11810.0af	17595.0as		
			21775.0af							
1600-1656		China Radio Int'l	7190.0af	9565.0af	9870.0af					
1600-1656		Radio Pyongyang	3560.0va	6520.0va	9600.0va	9975.0va				
1600-1700	a	Good News World Radio	15105.0af							
1600-1700		KSDA Guam	9355.0as							
1600-1700		Overcomer Ministries	5850.0eu	13810.0af						
1600-1700		Radio Algiers	11715.0va	15160.0va						
1600-1700		Radio Ethiopia	5990.0af	7110.0af	7165.0af	9560.0af	9704.2af	11800.0af		
1600-1700		Radio France Int'l	11615.0af	11995.0af	12015.0af	15210.0af	17605.0af	17850.0af		
1600-1700		Radio Korea	5975.0om	9515.0af	9870.0af					
1600-1700		Sri Lanka B'casting Corp.	4940.0do							
1600-1700		VOA	6035.0af	6160.0as	7125.0as	9645.0as	9700.0me	9760.0as		
			13710.0af	15205.0va	15225.0af	15255.0va	15410.0af			
1600-1700		VOA Special English	13600.0af	15445.0af	17895.0af					
1600-1700		Voice of Russia	9730.0eu	9875.0as	12015.0me	12025.0as	12055.0me	15515.0af		
1600-1700		WYFR Okeechobee FL	11830.0na	15600.0na	17750.0na	18980.0eu	21455.0eu	21525.0af		
1600-1730		TWR Swaziland	9500.0af							
1600-1800		African Beacon	6145.0af							
1600-1800		KHBN Palau	9955.0as	9965.0as						
1600-1800		KWHR Naalehu HI	9930.0as							

1600-1800		WSHB Cypress Creek SC	18910.0af						
1600-2100		Radio Rwanda	6055.0do						
1600-2100		Voice of Hope, Lebanon	6280.0me	11530.0va					
1600-2100	smtwhf	WMLK Bethel PA	9465.0eu						
1600-2200		WEWN Birmingham AL	11875.0na	13615.0na	15745.0eu				
1600-2305		Radio Nigeria, Lagos	3326.0do	4990.0do					
1600-2400		WINB Red Lion PA	13570.0eu						
1615-1630		BBC World Service	3915.0as	5975.0as	6190.0af	6195.0as	7160.0as	9515.0na	
			9740.0as	11940.0af	12095.0eu	15310.0as	15400.0af	15485.0eu	
			15575.0eu	17700.0as	17830.0af	17840.0am	21470.0af	21660.0af	
1615-1630	s	BBC World Service	11860.0af	15420.0af	21490.0af				
1615-1630		Vatican Radio	4005.0eu	5883.0eu	7250.0eu	9645.0eu	15595.0eu		
1625-1640		TWR Monte Carlo	6145.0me						
1630-1657		Radio Canada Int'l	6140.0as	7150.0as					
1630-1657		Voice of Vietnam	7145.0eu	9730.0eu					
1630-1700		BBC English Teaching	5875.0eu	9535.0eu	9915.0eu	11985.0eu	13650.0eu		
1630-1700		BBC World Service	3915.0as	5975.0as	6190.0af	6195.0as	7160.0as	9515.0na	
			9740.0as	11940.0af	12095.0eu	15310.0as	15400.0af	15420.0af	
			15485.0eu	15575.0eu	17700.0as	17830.0af	17840.0am	21470.0af	
			21660.0af						
1630-1700	s	BBC World Service	11860.0af	21490.0af					
1630-1700	s	FEBA Seychelles	11605.0as						
1630-1700		ORF Vienna	6155.0eu	13730.0va	15240.0me	17765.0as			
1630-1700		Radio Slovakia Int'l	5920.0eu	6055.0eu	7345.0eu				
1630-1730	mtwhf	Merlin Network One	12065.0as						
1630-1830		Radio Cairo	15255.0af						
1630-2200		Zimbabwe BC Corp.	4828.0do	6045.0do					
1645-1900		Deutsche Welle	6140.0eu						
1650-1850	mtwhf	Radio New Zealand Int'l	6145.0va						
1700-1727		Radio Prague Int'l	5930.0eu	21745.0af					
1700-1730		BBC World Service	3255.0af	3915.0as	5975.0as	6005.0af	6190.0af	7160.0as	
			9510.0as	9630.0af	9740.0as	12095.0eu	15400.0af	15420.0af	
			15485.0eu	15575.0me	17830.0af	17840.0na			
1700-1730		Channel Africa, S. Africa	17860.0af						
1700-1730		Georgian Radio, Tbilisi	11910.0eu						
1700-1730		Radio France Int'l	15210.0af	17605.0af					
1700-1730		VOA	6160.0as	7125.0as	7170.0as	9645.0as	9700.0me	9760.0af	
			15255.0va	15410.0af	15445.0af	17895.0af			
1700-1730	mtwhf	VOA	5990.0as	6045.0as	7150.0as	9550.0as	9770.0as		
1700-1730		Voice of Azerbaijan	9165.0eu						
1700-1755		Radio Polonia, Warsaw	6000.0eu	7285.0eu					
1700-1756		China Radio Int'l	9570.0af	9670.0af	9675.0af	11910.0af	13700.0af		
1700-1756		Radio Romania Int'l	15250.0eu	15390.0eu	17735.0eu	17805.0eu			
1700-1800	a	Good News World Radio	11795.0me						
1700-1800		R. Omdurman, Sudan	7200.0do	9200.0do	9505.0do				
1700-1800		Radio Australia	5995.0as	9475.0as	9580.0va	9815.0pa	11880.0va		
1700-1800		Radio Japan	9505.0na	12000.0eu	15355.0af				
1700-1800		Voice of Russia	9710.0eu	9775.0eu	9890.0eu	11510.0af	11675.0eu	12015.0af	
			12055.0me						
1700-1800	sm wh	Voice of Russia	9820.0eu						
1700-1800		WYFR Okeechobee FL	18980.0eu	21455.0eu					
1700-2000		WHRI Noblesville IN	9495.0sa	13760.0na					
1700-2200		Italian Radio Relay Svc	3980.0al	3985.0va					
1700-2300		Radio Africa, Eq. Guinea	5003.7af	7190.0af	15185.0af				
1700-2300		Sri Lanka B'casting Corp.	4940.0ir						
1700-2400		Ghana Broadcasting Corp.	3366.0do	4915.0do					
1700-2400		NBC Windhoek, Namibia	3270.1af	3289.9af					
1730-1745		BBC English Teaching	3390.0af	6070.0af	9520.0af				
1730-1745	m w	BBC English Teaching	6050.0eu	11955.0eu	15585.0eu				
1730-1745		BBC World Service	3255.0af	3915.0as	5975.0as	6005.0af	6190.0af	7160.0as	
			9510.0as	9630.0af	9740.0as	12095.0eu	15400.0af	15420.0af	
			15485.0eu	15575.0me	17830.0af	17840.0na			
1730-1745	s	BBC World Service	9750.0as	12045.0as	15310.0as				
1730-1745	mtwhf	TWR Swaziland	3200.0af						
1730-1745		Voice of Africa, Libya	11815.0af	15415.0af	15435.0va				
1730-1756		R. Vlaanderen Int'l	5910.0eu	9925.0eu	13710.0eu	17735.0af			
1730-1800		AWR Africa, Meyerton	12130.0af						
1730-1800	s	Georgian Radio, Tbilisi	6080.0eu						
1730-1800		KSDA Guam	11560.0as	11965.0as					
1730-1800	mtwhf	Merlin Network One	12065.0as	15560.0as					
1730-1800	mtwhfa	Radio Sweden	6065.0eu						
1730-1800	s	Radio Sweden	13800.0eu						
1730-1800		Vatican Radio	13765.0af	15570.0af	17515.0af				
1730-1800		VOA	6160.0as	7125.0as	7170.0as	9645.0as	9700.0me	9760.0af	
			15255.0va	15410.0af	15445.0af	17895.0af			
1730-1800	mtwhf	VOA	5990.0as	6045.0as	7150.0as	9550.0as	9770.0as		
1730-1830		Radio Netherlands	6020.0af	7120.0af	11655.0af				
1730-1930		Radio Pilipinas, Manila	11720.0pa	15190.0pa	17720.0pa				
1735-1745	t h	R. Nacional Paraguay	9737.5sa						
1745-1800		BBC English Teaching	6065.0as	9605.0as					
1745-1800		BBC World Service	3255.0af	3915.0as	5975.0as	6190.0af	7160.0as	9510.0as	
			9740.0as	12095.0eu	15400.0af	15420.0af	15485.0eu	15575.0me	
			17830.0af	17840.0na					
1745-1800	s	BBC World Service	9750.0as	12045.0as	15310.0as				
1745-1900		Radio Bangladesh	7184.0eu	7462.6eu	9558.0eu	15520.0eu			

1745-1945		All India Radio, Delhi	7410.0eu	9950.0eu	11620.0eu	11935.0af	13750.0af	15075.0af	
			15200.0af						
1745-2015		TWR Swaziland	3200.0af						
1800-1827		Voice of Vietnam	7145.0eu	7440.0eu	9730.0eu	12070.0eu			
1800-1830		AWR Africa, Meyerton	5960.0af	6100.0af					
1800-1830		BBC World Service	3255.0af	5975.0as	6190.0af	9410.0eu	9510.0as	9740.0pa	
			12095.0eu	15400.0af	15420.0af	15575.0as	17830.0af		
1800-1830		a BBC World Service	17840.0na						
1800-1830		Channel Africa, S. Africa	17870.0af						
1800-1830	mtwhf	Merlin Network One	12065.0as						
1800-1830		Radio Telefis Eireann	15315.0me						
1800-1830	s	Universal Life, Germany	11840.0af						
1800-1830		VOA	6035.0af	7415.0af	9760.0af	9770.0me	11975.0af	15410.0af	
			15580.0af	17895.0af					
1800-1900	m	Amtr Radio League, SAF	3215.0af						
1800-1900		KHBN Palau	9965.0as						
1800-1900		KJES Vado NM	15385.0au						
1800-1900	hf	Merlin Network One	6130.0af						
1800-1900		Radio Taipei Int'l	3955.0eu						
1800-1900	mtwhf	RAE Buenos Aires	15345.0eu						
1800-1900		Republic of Yemen Radio	9780.0me						
1800-1900	s	Voice of Greece	9420.0eu	15630.0af	17705.0na				
1800-1900		Voice of Russia	7330.0eu	9710.0eu	9720.0eu	9775.0eu	9820.0eu	9890.0eu	
			11510.0af	11675.0eu	11695.0af	12015.0af			
1800-2000		Radio Australia	6080.0pa	7240.0pa	9475.0as	9580.0pa	9815.0pa	11880.0va	
1800-2000		WYFR Okeechobee FL	18980.0eu						
1800-2100		Radio Kuwait	11990.0va						
1800-2200		African Beacon	9675.0af						
1800-2200		Radio Botswana	3356.0do	4820.0do					
1800-2200		WSHB Cypress Creek SC	15665.0eu	18910.0af					
1800-2400		KWHR Naalehu HI	17510.0as						
1800-2400		Radio Liberia Int'l	5100.0do						
1805-1810		Croatian Radio, Zagreb	13830.0eu						
1830-1845		Radio Tirana, Albania	7180.0eu	9510.0eu					
1830-1900		BBC World Service	3255.0af	6005.0af	6190.0af	9410.0eu	9630.0af	9740.0pa	
			12095.0eu	15400.0af	15420.0af	15575.0as	17830.0af		
1830-1900		a BBC World Service	17840.0na						
1830-1900		Georgian Radio, Tbilisi	11760.0eu						
1830-1900		ORF Vienna	13730.0af						
1830-1900		Radio Slovakia Int'l	5920.0eu	6055.0eu	7345.0eu				
1830-1900		Radio Telefis Eireann	13725.0na	21630.0af					
1830-1900		Radio Yugoslavia	6100.0eu						
1830-1900		VOA	6035.0af	7415.0af	9760.0af	9770.0me	11975.0af	15410.0af	
			15580.0af	17895.0af					
1830-1900	s	a VOA	7170.0af	11940.0af	15525.0af				
1830-1930		Voice of Turkey	9785.0eu	11765.0af					
1830-2030		Radio Netherlands	6020.0af	7120.0af	9895.0af	11655.0af	13700.0af	17605.0af	
			21590.0af						
1830-2400		Radio Kiribati	9809.9do	9825.0do					
1850-1855	mtwhf	Radio New Zealand Int'l	11725.0pa						
1855-1950		Radio New Zealand Int'l	11725.0pa						
1900-1915		BBC English Teaching	15105.0af	17885.0af					
1900-1925		Kol Israel	11605.0va	15640.0af	15650.0va	17535.0va			
1900-1927		Voice of Vietnam	7145.0eu	9730.0eu					
1900-1930		Radio Budapest	6025.0eu	9750.0eu					
1900-1930		Swiss Radio Int'l	6110.0eu						
1900-1930		VOA	7260.0me	9525.0pa	9760.0af	9770.0af	12040.0pa	15180.0pa	
1900-1930	s	a VOA	6035.0af	7375.0af	7415.0af	11975.0af	15410.0af	15445.0af	
			15580.0af						
1900-1930	mtwhf	VOA	9565.0eu	9840.0as	11780.0me	11970.0as	12015.0as	13725.0me	
			15235.0as						
1900-1930		a VOA	4950.0af						
1900-1930		a WRMI Miami FL	9955.0am						
1900-1945		Deutsche Welle	11785.0af	11810.0af	13720.0af	15390.0af	17810.0af		
1900-1956		China Radio Int'l	9440.0af	9595.0af	11750.0af				
1900-1956		Radio Pyongyang	4405.0va	6574.9na	9335.2na	11710.0na	13760.1na		
1900-2000		BBC World Service	3255.0af	6005.0af	6190.0af	6195.0eu	9410.0eu	9630.0af	
			9740.0pa	12095.0eu	15400.0af	15575.0me	17830.0af		
1900-2000		a BBC World Service	17840.0na						
1900-2000	hf	Merlin Network One	6010.0eu						
1900-2000		Radio Bulgaria	7535.0eu	9400.0eu	11700.0eu				
1900-2000		Radio Korea	5975.0om	7275.0eu					
1900-2000		Radio Thailand	7195.0eu	9655.0eu	11905.0eu				
1900-2000		a Sri Lanka B'casting Corp.	6010.0eu						
1900-2000	smtwh	a V. of the Mediterranean	12060.0eu						
1900-2000		VOA Special English	6160.0me	9680.0me	13690.0me				
1900-2000		Voice of Russia	9710.0eu	9775.0eu	9820.0eu	9890.0eu	11675.0eu	12070.0eu	
1900-2100		SIBC Solomon Islands	5020.0do						
1900-2100		Voice of Nigeria	7255.0af	15120.0af					
1900-2200		HCJB Quito Ecuador	17660.0eu						
1900-2400		SLBS, Sierra Leone	3316.0do						
1930-1945		Radio Finland	6110.0eu						
1930-1956		R. Vlaanderen Int'l	5960.0eu						
1930-2000	t h	Radio Minsk, Belarus	7210.0as	11960.0eu					
1930-2000		Radio Polonia, Warsaw	6035.0eu	7185.0eu	7265.0eu	9525.0eu			
1930-2000		Radio Sweden	6065.0eu						

1930-2000		VOA	4950.0af 9760.0af 15445.0af	6035.0af 9770.0af 15580.0af	7260.0me 11975.0af 12040.0pa	7375.0af 12040.0pa	7415.0af 15180.0pa	9525.0pa 15410.0af
1930-2000	mtwhf	VOA	9565.0eu 15235.0as 9955.0am	9840.0as	11780.0me 11970.0as		12015.0as	13725.0me
1930-2000	s	WRMI Miami FL	9022.1eu	9575.0eu	11670.0eu			
1930-2030		VOIRI Teheran	3245.0do	3275.0do	3290.0do	3345.0do	3355.0do	3365.0do
1930-2200		Nat'l BC, Papua NG	4890.0do	5970.0eu	9750.0eu			
1935-1955		RAI, Rome	9660.0eu					
1940-1950	m	Vatican Radio	4005.0eu	5883.0eu	7250.0eu	9645.0eu		
1950-2000	m	Vatican Radio	9660.0eu					
1950-2400		Radio New Zealand Int'l	17675.0pa					
1955-2000	mtwhfa	Voice of Armenia, Yerevan	4810.0eu	9965.0eu				
2000-2010		Vatican Radio	4005.0eu 13765.0af	5883.0eu	7250.0eu	9645.0eu	9660.0af	11625.0af
2000-2015	mtwhfa	Voice of Armenia, Yerevan	4810.0eu	9965.0eu				
2000-2025		Radio Polonia, Warsaw	6035.0eu	7185.0eu	7265.0eu	9525.0eu		
2000-2027		Radio Prague Int'l	5930.0eu	11600.0as				
2000-2030		Swiss Radio Int'l	13710.0af	13770.0af	15220.0af	17580.0af		
2000-2030		VOA	4950.0af 9770.0af 17725.0af	6035.0af 11855.0af 17745.0af	6095.0me 11975.0af 12085.0eu	7375.0af 15410.0af	7415.0af 15445.0af	9760.0af 15580.0af
2000-2030		Voice of Mongolia	12015.0eu					
2000-2045		BBC World Service	3255.0af 9630.0af	5975.0pa 9740.0pa	6005.0af 11835.0eu	6190.0af 12095.0eu	6195.0eu 15400.0af	9410.0eu 17830.0af
2000-2045		Deutsche Welle	7130.0eu					
2000-2056		China Radio Int'l	9440.0af	11735.0af	13640.0af	15110.0eu	17790.0eu	
2000-2100		KJES Vado NM	15385.0au					
2000-2100		R. Nacional de Angola	3374.9va	7245.0va				
2000-2100		Radio Algiers	11750.0eu	15160.0eu				
2000-2100		Radio Australia	9500.0as	9580.0va	9815.0pa	11880.0va	12080.0va	
2000-2100		Radio Canada Int'l	5995.0va 17820.0va	11690.0va 17870.0va	13650.0va 13670.0va	13670.0va	15325.0va	15470.0va
2000-2100	mtwhf	Radio Exterior de Espana	9595.0af	15285.0eu				
2000-2100		Radio Iraq Int'l	7157.0ir	9684.0ir	11787.0ir			
2000-2100		Voice of Hope, Lebanon	6280.0me	11530.0va				
2000-2100		Voice of Indonesia	9525.0va	11784.9va	15149.8va			
2000-2100		Voice of Russia	9775.0eu	9820.0eu	9890.0eu	11675.0eu	15485.0eu	
2000-2100	s	WRMI Miami FL	9955.0am					
2000-2100	a	WRMI Miami FL	7385.0na					
2000-2100		WYFR Okeechobee FL	17845.0af	18980.0eu				
2000-2200		Radio Damascus	12085.3eu	13610.0eu				
2000-2400		Radio Vanuatu	3945.0do	4960.0do	7260.0do			
2000-2400		WBCQ Monticello ME	7415.0na					
2000-2400		WHRI Noblesville IN	5745.0sa	9495.0sa				
2000-2400		ZLXA New Zealand	3935.0do	7290.0do				
2005-2010		Croatian Radio, Zagreb	9430.0al	11805.0af				
2010-2030		Vatican Radio	9660.0af	11625.0af	13765.0af			
2025-2045		RAI, Rome	7125.0af	9710.0af	11880.0af			
2030-2045		Radio Thailand	9655.0eu	9680.0eu	11905.0eu			
2030-2045		Voice of Africa, Libya	11815.0af	15415.0af	15435.0va			
2030-2055		Radio Moldova Int'l	7520.0eu					
2030-2057		Voice of Vietnam	7145.0eu	9730.0eu				
2030-2100		AWR Africa, Meyerton	9745.0af					
2030-2100		AWR Europe, Germany	15560.0af					
2030-2100		BBC English Teaching	5875.0eu	6050.0eu	9635.0eu			
2030-2100	t h	Radio Minsk, Belarus	7210.0af	11960.0af				
2030-2100		Radio Tashkent	9540.0eu	9545.0eu				
2030-2100		VOA	6035.0af 11975.0af	6095.0me 15410.0af	7375.0af 15445.0af	7415.0af 15580.0af	9760.0af 17725.0af	9770.0af 17745.0af
2030-2100	s	VOA	4950.0af					
2030-2100	f	Wales Radio Int'l	7325.0eu					
2030-2115		Radio Cairo	15375.0af					
2030-2130		Radio Havana Cuba	13660.0uf	13750.0eu				
2030-2130		Voice of Turkey	9525.0as					
2045-2100		BBC World Service	3255.0af 9630.0af	5975.0pa 9740.0pa	6005.0af 11835.0af	6190.0af 12095.0eu	6195.0eu 15400.0af	9410.0eu 17830.0af
2045-2230		All India Radio, Delhi	7150.0au	7410.0eu	9650.0eu	9910.0au	9950.0eu	11715.0au
2100-2115		BBC World Service	3255.0af 6195.0va 15400.0af	3255.0af 9410.0eu	3915.0as 9740.0pa	5975.0va 11835.0af	6005.0af 11945.0as	6190.0af 12095.0as
2100-2115	mtwhf	BBC World Service	11675.0ca					
2100-2130		China Radio Int'l	11735.0af	13640.0af	15110.0eu	17790.0eu		
2100-2130		Radio Australia	7240.0pa 17715.0pa	9500.0as 21740.0va	9580.0va	9660.0pa	11880.0va	12080.0va
2100-2130		Radio Budapest	6025.0eu					
2100-2130		Radio Korea	3970.0eu	6480.0eu	15575.0eu			
2100-2130		Radio Yugoslavia	6100.0eu					
2100-2130		VOA	6035.0af 9705.0as 15445.0af	6040.0me 9760.0eu 15580.0af	6095.0me 11870.0pa 17725.0af	7375.0af 11975.0af 17740.0as	7415.0af 15185.0as 17820.0as	9535.0af 15410.0af
2100-2145		Deutsche Welle	9670.0as	9765.0as	9775.0af	11865.0af	11915.0as	15135.0va
2100-2145		WYFR Okeechobee FL	15120.0af	17845.0af	18980.0eu			
2100-2156		Radio Pyongyang	6574.9	9335.2				

2100-2156		Radio Romania Int'l	11740.0eu	11940.0eu	15105.0eu	15180.0eu		
2100-2200		KHBN Palau	9985.0as					
2100-2200		Radio Bulgaria	9400.0eu	11700.0eu				
2100-2200		Radio Canada Int'l	7235.0va	11690.0va	13650.0va	13670.0va	15325.0va	17820.0va
			17870.0va					
2100-2200	s	Radio Exterior de Espana	9595.0af	9840.0eu				
2100-2200		Radio Japan	6035.0pa	9725.0eu	11850.0pa	11855.0af	17825.0na	21670.0pa
2100-2200		Radio Ukraine Int'l	5905.0eu	6020.0eu	9640.0eu	11950.0eu		
2100-2230		SIBC Solomon Islands	5020.0do	9545.0do				
2100-2245	s	WRMI Miami FL	9955.0am					
2100-2245		WRMI Miami FL	7385.0na					
2100-2400		Global Sound Kitchen	3955.0eu	6140.0eu	7325.0eu			
2100-2400	mtwhf	WBCQ Monticello ME	9330.0na					
2115-2130	mtwhf	BBC Caribbean Report	5975.0ca	11675.0ca	15390.0ca			
2115-2130		BBC World Service	3255.0af	3915.0as	5965.0as	5975.0pa	6005.0af	6190.0af
			6195.0va	9410.0eu	9740.0pa	11835.0af	11945.0as	12095.0sa
			15400.0af					
2115-2130	s	BBC World Service	5975.0ca					
2115-2200		Radio Cairo	9990.0eu	15375.0af				
2130-2145	t f	BBC Cailing Falklands	11680.0sa					
2130-2156		China Radio Int'l	15110.0eu	17790.0eu				
2130-2157		Radio Prague Int'l	11600.0as	15545.0af				
2130-2200		BBC World Service	3255.0af	3915.0as	5965.0as	5975.0va	6005.0af	6190.0af
			6195.0va	9410.0eu	9740.0pa	11835.0af	11945.0as	12095.0sa
			15400.0af					
2130-2200		KSDA Guam	11980.0as	15550.0as				
2130-2200		ORF Vienna	5945.0eu	6155.0eu	13730.0af			
2130-2200		Radio Australia	7240.0pa	9660.0pa	11880.0va	12080.0va	17715.0pa	21740.0va
2130-2200		Radio Budapest	3975.0eu					
2130-2200		Radio Korea	15575.0eu					
2130-2200		Radio Sweden	6065.0eu	9435.0eu	15255.0as			
2130-2200		Radio Tashkent	9540.0eu	9545.0eu				
2130-2200		Radio Tirana, Albania	7130.0eu	9540.0eu				
2130-2200		VOA	6040.0me	6095.0me	9535.0af	9705.0as	9760.0eu	11870.0pa
			15185.0as	17740.0as	17820.0as			
2130-2200	smtwhf	VOA	6035.0af	7375.0af	7415.0af	11975.0af	15410.0af	15445.0af
			15580.0af	17725.0af				
			11740.0as	13745.0as				
2130-2225		VOIRI Teheran	4835.0do					
2130-2400		ABC Alice Springs	5025.0do					
2130-2400		ABC Katherine	4910.0do					
2130-2400		ABC Tennant Creek	15120.0af	17845.0af				
2145-2200		WYFR Okeechobee FL	11705.0af					
2200-2215	sm w f	Reformed Faith and Life	9675.0as	11900.0as	15240.0as			
2200-2225		RAI, Rome	5965.0as	5975.0na	6175.0na	6195.0va	7110.0as	9590.0na
2200-2230		BBC World Service	9660.0as	11835.0af	11955.0as	12080.0pa	12095.0sa	15400.0af
			5960.0am	9755.0am	13670.0am	15305.0am	17695.0am	17835.0as
2200-2230		Radio Canada Int'l	5985.0am	9705.0am				
2200-2230	smtwhf	Radio Mexico Int'l	7230.0au					
2200-2230		Radio Yugoslavia	7215.0as	9705.0as	9770.0as	11760.0as	15185.0as	15290.0as
2200-2230		VOA	15305.0as	17740.0as	17820.0as			
			6035.0af	7340.0af	7375.0af	7415.0af	11975.0af	
2200-2245	mtwhf	VOA	9990.0eu					
2200-2245		Radio Cairo	11740.0na	15120.0af	17845.0af			
2200-2256		WYFR Okeechobee FL	9880.0eu					
2200-2300		China Radio Int'l	7295.0sa					
2200-2300		Overcomer Ministries	17715.0pa	17795.0va	21740.0va			
2200-2300		Radio Australia	11565.0eu	15600.0eu				
2200-2300		Radio Taipei Int'l	7190.0eu	13640.0va				
2200-2300		Voice of Turkey	7580.0af					
2200-2300		WHRA Greenbush ME	6090.0am					
2200-2400		Caribbean Beacon	9955.0as	9965.0as	9985.0as			
2200-2400		KHBN Palau	7295.0do					
2200-2400		RTM Radio 4, Malaysia	3289.8do	5949.4do				
2200-2400		Voice of Guyana	9385.0na	9975.0eu	13615.0na			
2200-2400		WEWN Birmingham AL	5085.0va	6890.0uf				
2200-2400		WGTE McCaysville GA	13770.0eu	15285.0sa				
2200-2400		WSHB Cypress Creek SC	5070.0na	7435.0na	9475.0na	13845.0na		
2200-2400		WWCR Nashville TN	15565.0na					
2230-2256		R. Vlaanderen Int'l	11600.0na	15545.0na				
2230-2257		Radio Prague Int'l	5965.0as	5975.0na	6175.0na	6195.0va	7110.0as	9590.0na
2230-2300		BBC World Service	9660.0as	11835.0af	11955.0as	12080.0pa	12095.0sa	15400.0af
			5960.0na	9755.0na	13670.0na			
2230-2300		Radio Canada Int'l						
			7215.0as	9705.0as	9770.0as	11760.0as	15185.0as	15290.0as
			15305.0as	17740.0as	17820.0as			
2230-2330		Radio Havana Cuba	9550.0am					
2230-2400		Nat'l BC, Papua NG	9675.0do	11880.0do				
2230-2400	s	SIBC Solomon Islands	5020.0do					
2230-2400		SIBC Solomon Islands	9545.0do					
2245-2300		Vatican Radio	9600.0as	11830.0as				
2245-2300	smtwhf	WRMI Miami FL	9955.0am					
2245-2300		WRMI Miami FL	7385.0na					
2245-2345		WYFR Okeechobee FL	11740.0na					
2245-2400		All India Radio, Delhi	7410.0as	9705.0as	9950.0as	11620.0as	13625.0as	
2300-2315		Vatican Radio	9600.0as	11830.0as				

2300-2330	Radio Canada Int'l	5960.0am	9755.0am	11895.0am	13670.0am	15305.0am	17695.0am
2300-2330	Radio Mexico Int'l	5985.0am	9705.0am				
2300-2330	VOA Special English	7190.0as	7200.0as	9545.0as	9795.0as	11925.0as	
2300-2345	Deutsche Welle	9815.0as	12055.0as	13610.0as	21790.0as		
2300-2356	Radio Romania Int'l	9690.0eu	11775.0na	11830.0eu	15105.0na		
2300-2400	BBC World Service	3915.0as	5965.0as	5975.0na	6035.0as	6175.0na	6195.0as
		7110.0as	9590.0na	11945.0as	11955.0as	12095.0sa	15280.0as
2300-2400	Radio Australia	9660.0pa	12080.0va	17715.0pa	17795.0va	21740.0va	
2300-2400	Radio Bulgaria	9400.0na	11700.0na				
2300-2400	Radio Cairo	9900.0am					
2300-2400	a Radio Finland	11985.0as	13785.0as				
2300-2400	SBC Radio 1, Singapore	6150.0do					
2300-2400	Sri Lanka B'casting Corp.	4940.0do					
2300-2400	VOA	7215.0as	9705.0as	9770.0as	11760.0as	15185.0as	15290.0as
		15305.0as	17740.0as	17820.0as			
2300-2400	WHRA Greenbush ME	7580.0na					
2300-2400	WRMI Miami FL	9955.0am					
2300-2400 s	a WWBS Macon GA	11915.0eu					
2330-2345	Voice of Africa, Libya	11815.0af	15415.0af	15435.0va			
2330-2357	Voice of Vietnam	7145.0as	12019.5as				
2330-2359	Radio Canada Int'l	5960.0am	9755.0am	13670.0am			
2330-2359 s	a Radio Canada Int'l	11895.0am	15305.0am	17695.0am			
2330-2400	Radio Netherlands	6165.0na	9845.0na				
2330-2400	VOA Special English	6060.0as	7190.0as	7200.0as	7225.0as	7260.0as	9545.0as
		9795.0as	11805.0as	11925.0as	13735.0as	15205.0as	
24hr-	AFRTS	4278.5uf	6458.5uf	12689.5uf			
24hr-	CFRX Toronto ON	6070.0do					
24hr-	CFVP Calgary AB	6030.0do					
24hr-	CHNX Halifax NS	6130.0do					
24hr-	CKZN Saint John's NL	6160.0do					
24hr-	CKZU Vancouver BC	6160.0do					
24hr-	University Network	5030.1am	6150.0va	7375.0na	9725.0na	11870.0	13749.8af
24hr-	WJCR Upton KY	7490.1va	13594.5as				
24hr-	WTJC Newport NC	9370.7na					

Key:

Days:	Target Areas:	Other Notes:
s - Sunday	na - North America	va - Various
m - Monday	ca - Central America	do - Domestic
t - Tuesday	sa - South America	om - Omnidirectional
w - Wednesday	am - Americas	
h - Thursday	eu - Europe	ir - Irregular
f - Friday	af - Africa	oc - Occasional
a - Saturday	me - Middle East	al - Alternate
	as - Asia	lf - Lower Sideband
	pa - Pacific	uf - Upper Sideband

FOR SALE: Radio stuff! Radio hobby and related books, station pamphlets and memorabilia, magazines, WRTBs and much more. Send an SASE with two stamps or \$1.00 for the ten-page list. Gerry Dexter, 213 Forest Street, Lake Geneva, WI 53147.

WORLD OF RADIO AND CONTINENT OF MEDIA
SHORTWAVE-ONLY SCHEDULE AS OF APRIL 17, 2000

Days and times strictly UT. RFPI activated new 6970 April 16,
and new frequency schedule effective April 17 is now shown.
We have new times on WBCQ and WWCR.

Wed 1730 COM RFPI 25930-USB 15049
Wed 2330 WOR WBCQ1 7415 [ex-2130 from April 19]
Thu 2030 WOR WWCR 15685
Thu 2300 WOR RFPI 25930-USB 15049
Fri 0700 WOR RFPI 6970
Fri 0930 WOR WWCR 7435
Fri 1500 WOR RFPI 25930-USB
Fri 1900 COM RFPI 25930-USB 15049
Fri 1930 WOR RFPI 25930-USB 15049
Fri 2030 WOR WBCQ2 9330-CUSB
Sat 0300 COM RFPI 25930-USB 15049 6970
Sat 0330 WOR RFPI 25930-USB 15049 6970
Sat 0300 WOR WWCR 3215
Sat 1100 COM RFPI 6970
Sat 1130 WOR RFPI 6970
Sat 1130 WOR WWCR 15685
Sat 1730 COM RFPI 25930-USB 15049
Sat 1800 WOR RFPI 25930-USB 15049
Sun 0130 COM RFPI 25930-USB 15049
Sun 0200 WOR RFPI 25930-USB 15049
Sun 0230 WOR WWCR 5070
Sun 0630 WOR WWCR 5070
Sun 0930 COM RFPI 6970
Sun 1000 WOR RFPI 6970
Sun 2300 WOR RFPI 25930-USB 15049
Mon 0030 WOR WWCR 3215 [NEW April 17, soon shifting
to Sun 2330 on 9475]
Mon 0501 WOR WWCR 3210
Mon 0700 WOR RFPI 6970
Mon 1500 WOR RFPI 25930-USB
Tue 1100 WOR WWCR 15685
Tue 1900 WOR RFPI 25930-USB 15049
Tue 2000 COM RFPI 25930-USB 15049
Wed 0300 WOR RFPI 25930-USB 15049 6970
Wed 0400 COM RFPI 25930-USB 15049 6970
Wed 1200 COM RFPI 25930-USB

For an exhaustive schedule of all our broadcasts and outlets see
<http://www.angelfire.com/ok/worldofradio/wormast.html>

WOR can also be heard at <http://www.wrn.org/ondemand>
COM can also be heard at <http://www.DXing.com>

Regards, Glenn

Company Store

Bill Bergadano KA2EMZ • P.O. Box 484 • Colts Neck, NJ 07722 • ka2emz@cybercomm.net

All s/h charges for the following items are included unless otherwise noted. Please note the new proprietor and address.

Publications

Transmitter Documentation Project (TDP) A result of 10 years of research by DXer Ludo Maes, the TDP presents 80 pages of info listing SW broadcast tx'ers worldwide by country with station name, tx'er site, geographical coordinates, callsign and more	\$10.00 US/CA \$13.00 worldwide
Shortwave Listening Guidebook by Harry Helms. Covers equipment, antennas, propagation, station profiles, utilities, clandestines, QSL'ing, etc. 315 pages.	\$19.95 +2.00 s/h US/CA +3.00 s/h world
Limited Space Antenna Solutions by Frank P. Hughes. Covers the random wire, dipole, vertical, outdoor, loft and indoor antennas, antenna tuners, and grounds.	\$13.00 +1.00 s/h US/CA +2.00 s/h world
Inside Your Shortwave Radio by Ted Benson. Companion to your receiver's instruction manual, filling in what your manual leaves unclear.	\$13.95 +2.00 s/h US/CA +2.50 s/h world
Underground Frequency Guide (New to Company Store!) by Donald W. Schimmel. An in-depth look at illegal radio communications; pirate, spies and so much more! Lists hundreds of frequencies & diplomatic radio systems worldwide. A book no pirate or clanny enthusiast should be without!	\$11.00 +2.00 s/h all
Joe Carr's Receiving Antenna Handbook (Back in stock) A complete guide for high performance antennas from longwave all the way to the upper end of the shortwave spectrum.	\$19.95 +2.00 s/h US/CA +3.00 s/h world
The Vacuum Tube Era (New to our line!) Reviews the golden years of vacuum tube receivers, 1932-1981. If you feel real radios glow in the dark, this is for you! 141 pages.	\$17.00 +1.00 s/h worldwide
Shortwave Receivers, Past & Present by Fred Osterman. A comprehensive guide to over 770 shortwave, amateur and commercial communications receivers produced in the last 55 years! Over 800 photos. 473 pages.	\$22.95 +2.00 s/h US/CA +3.00 s/h world
NASWA Country List and Awards Program Booklet	\$3.00 PP US/CA \$5.00 elsewhere
The System Log Book Masters, QSL reports and log, program notes.	\$2.00 PP worldwide
Propagation Predictor Divides the year into 27-day segments for tracking solar patterns.	\$3.00 PP worldwide
Spectrum Log Covers Tropical and International bands.	\$8.50 PP worldwide
NASWA Reprints Catalog A catalog of 800+ pages of info available from past NASWA issues.	\$3.00 PP worldwide
QSL Signers by Al Quaglieri. The most comprehensive and up-to-date list of verification signers names, titles, and addresses available anywhere!	\$3.00 PP US/CA \$5.00 elsewhere

Make checks payable in U.S. funds to "The NASWA Company Store."



North American Shortwave Association
45 Wildflower Road
Levittown, Pennsylvania, 19057

First Class Mail
U.S. Postage
PAID
Levittown, PA
Permit No. 319

FIRST CLASS MAIL



ISSN 0160-1989

The Journal of the
North American Shortwave Association

Executive Director: Richard A. D' Angelo, 2216
Burkey Dr., Wyomissing, PA 19610

Publisher/Business Manager: Bill Oliver, 45
Wildflower Road, Levittown, PA 19057

Executive Council: Jerry Berg, Ralph Brandi,
Bob Brown, Dr. Harold Cones, Rich D' Angelo,
Fred Kohlbrenner, Bill Oliver

EDITORIAL STAFF

Managing Editor: Dr. Harold Cones, 2 Whits
Court, Newport News, VA 23606

Desktop Publishing/Graphics: Ralph Brandi,
P.O. Box 491, Lincroft, NJ 07738

Shortwave Center: Jerry Lineback, 506 S.
Lawrence Ave., Scranton, KS 66537

Easy Listening: Richard Cuff, 327 Springhouse
Road, Apt. 102, Allentown, PA 18104

Listener's Notebook: Al Quaglieri, P.O. Box
888, Albany, NY 12201-0888

Technical Topics: Joe Buch, N2JB, P.O. Box
1552, Ocean View, DE 19970-1552

QSL Report: Sam Barto, 47 Prospect Place,
Bristol, CT 06010

Distributing Editor: Fred S. Kohlbrenner, 2641
S. Shields St., Philadelphia, PA 19142

Tropical Band Loggings: Sheryl Paszkiewicz,
P.O. Box 152, Manitowoc, WI 54221-0152

International Band Loggings: Wallace C.
Treibel, 357 N.E. 149th St., Seattle, WA 98155

Net Notes: Tom Sundstrom, W2XQ P.O. Box 2275,
Vincentown, NJ 08088-2275

Scoreboard: Fred S. Kohlbrenner, 2641 S. Shields
St., Philadelphia, PA 19142

NASWA Awards: Dr. Harold Cones, 2 Whits
Court, Newport News, VA 23606

English Schedules: Mark J. Fine, 11252
Cardinal Drive, Remington, VA 22724-2032

Listener's Library: Skip Arey, N2EI
P.O. Box 236, Beverly, NJ 08010

Equipment Reviews: Alan Johnson, N4LUS
2490 Sharon Way, Reno, NV 89509

The Company Store: Dan Cashin, 1335
Harrington Road, Havertown, PA 19083

MEMBERSHIP FEES:

United States (First Class Mail) \$26.00

Canada & Mexico (First Class Mail) \$27.00

Overseas (ISAL Mail):

Central & South America and Europe \$30.00

Asia, Africa and Pacific \$32.00

Overseas (Air Mail):

Central & South America and Europe \$36.00

Asia, Africa and Pacific \$42.00

All remittances must be in U.S. funds and mailed to:

NASWA
45 Wildflower Road
Levittown, PA 19057
U.S.A.



NASWA Web: <http://www.anarc.org/naswa/>