

# FRENDX

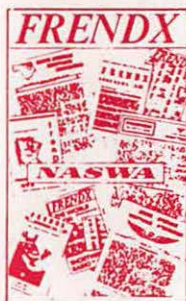

H  
A  
P  
P  
Y



H  
O  
L  
I  
D  
A  
Y  
S



NASWA  
FRENDX



NO COLLECT CALLS ON THESE ADS, PLEASE

FOR SALE: Sony ICF-2001 in excellent condition with accessories including AC adapter, wave guide book, and carrying strap, \$100.00. Panasonic RF-2900, also in excellent condition, \$150.00. Sony ICF-S5W with modification for receiving FM SCA broadcasts, \$50.00. All prices include shipping. Mike Levintow, 2829 Connecticut Avenue, N.W. #710, Washington, DC 20028. Phone (202) 387-4312.

FOR SALE OR TRADE: Yaesu FRT-7700 antenna tuner, US\$50.00 and shipping or trade for Autek QF-1A, Yaesu FRA-7700, MFJ-1020 or other. Boris Benkovich, 342 West Queens Road, North Vancouver, B.C., Canada V7N 2K5. Phone (604) 988-8600 from 0000 to 0500 UTC.

WANTED: Drake RV75 VFO. Mint or excellent condition only, please. Also have for sale Gilfer M-1 Multi-tuner. Unit has been modified to incorporate an in-out switch. Good condition, \$23.00. Also, Drake Model 2-B communications receiver/Model 2-BQ Q-Multiplier. Includes manual, extra tubes, and crystals for major SW bands. In good condition, \$125.00. I ship. Steven R. Lare, 824 West 25th Street, Holland, MI 49423.

FOR SALE: Realistic DX-302. Three years old, but in excellent condition, \$150.00 firm. Tom Laskowski, Box 1812 Harrison Hall, West Lafayette, IN 47906. Phone (317) 495-3112 evenings and (219) 234-8598 from December 16 to January 13.

FOR SALE: 1983 Model ICOM IC-R70. Excellent condition, untouched, \$500.00 postage paid or best offer. Also Drake SPR-4 with AL-1 loop antenna and all SW and ham crystals. In good shape, clean, \$230.00, postage extra. Fritz Mellberg, 1505 Central, Hawarden, IA 51023. Phone (712) 552-2458.

FOR SALE; MFJ-1020 active antenna with AC adapter. Excellent condition, \$40.00. Back issues of FRENEX: Oct-Dec 1976; Jan-June, Aug, Sept 1977; Jan, Mar-Dec 1981; Feb-Dec 1982; Jan-Dec 1983; Jan-present 1984. Pete Giacobelli, 305 Ocean Avenue, Malverne, NY 11565. Phone (516) 887-9881.

FOR SALE: DX supplies. Reception report cards in SP, EG, PT, and FR and prepared QSL's in SP, PT, and FR, 50 for \$5.00. Fifty-page log books, 2 for \$4.00 or 4 for \$7.00. #10 airmail envelopes, 50 for \$4.00 or 100 for \$6.00. All ppd by first class mail or UPS. William Plum, RD8 Glenn Road, Flemington, NJ 08822.

WANTED: 1966, 1967 and 1968 back issues of FRENEX. Will buy or copy and return. Also 1966 and 1967 issues of the WRTH. I will pay all postage/shipping. Tom Daly, 132 Richard Court, Pomona, NY 10970.

FOR SALE: Yaesu FRG-7 with Gilfer Modifications. Excellent Condition. Original carton, instructions. \$170.00 ppd shipped UPS. Bill Potorti, 912 Plumas Street, Reno NV 89509. Phone (702) 768-0244.

FOR SALE: Kenwood R-2000, Radio West modified with 2 Collins mechanical filters (2.9 and 1.9 kHz) and 1 ceramic filter (4 kHz) for only \$675.00. Sony ICF-6800W -orange- \$400.00. Both in mint condition with manuals and original cartons. UPS insured. Fritz Apollon, M.D., 3412 Englehead Road, Baltimore, MD 21208. Phone (301) 653-0212 from 0000 to 0300 GMT.

**1985 WRTH SPECIAL PRE-PUBLICATION OFFER**

Once again the Canadian International DX Club is offering (in Canada only) the 1985 WRTH at a special pre-publication discount price. The 1985 WRTH has gone up \$2 this year in the US (\$17.50 to \$19.50) which will bring the Canadian list up from \$24.95 to over \$27 (exact list not known yet). Advance orders to CIDX HQ will now be accepted (till Jan 1, 1985) for the books (don't expect delivery till Feb/March 1985!) at the following rates:

\$22 each, postpaid. OR \$25 each SPECIAL DELIVERY postpaid.

Quantity orders (3 or more): subtract 1\$ per book, either method of shipping.

We also have several other useful books in stock including the Gilfer Confidential Frequency List (\$18 ppd) and the Grove Shortwave Directory (\$16.75 ppd). Sample copies of our monthly bulletin, the "Messenger" are available for \$1. Orders to: CIDX, 6815 - 12 Avenue, Edmonton, Alberta T6K 3J6

FRENDX is the monthly publication of the North American Shortwave Association. All items contained herein with the exception of BBC WMS information may be copied by other bulletins providing proper credit is given to NASWA/FRENDX, the column editor, and original contributor. Target mailing date for FRENDX is the Friday before the first Saturday of the month. Contributions to the Log Report may be sent to the Distributing Editor whose address appears on the back cover.

### RADIO JAPAN ESSAY CONTEST

This may reach you a little late, but if you write fast, you may make the deadline. To commemorate the opening of the International Science Exhibition at the Tsukuba Science City near Tokyo, Radio Japan is holding an essay contest for listeners all over the world. The station asks you to give your thoughts and feelings about how science will be changing our lives in the future. Any of the following three themes may be used:

- 1) Approaching the 21st Century  
--Scientific Progress and Our Daily Lives--
- 2) In What Ways Can Science and Technology  
Be Used to Help the Developing World?
- 3) What is Japan's Proper Role in This Age of  
Science and Technology?

The winners will receive the latest Japanese shortwave radio or a gift of equivalent value and the best entries will be broadcast on Radio Japan in March, 1985. The entries should reach Radio Japan by December 15, 1984. The address is: Expo '85 Prize Essay Contest, Radio Japan, Tokyo 150, Japan.

### A\*C\*E RBBS

The Association of Clandestine Radio Enthusiasts (A\*C\*E) has setup a remote computer bulletin board system to contain general SW information in addition to information on Spy, Pirate, Euro-pirate, and Clandestine broadcasters. This A\*C\*E RBBS is an IBM PC, online 24 hrs. and supports 300/1200 baud. The number is (913) 677-1288. It is located in Kansas City, KS and is operated by A\*C\*E logging editor Kirk Baxter. Access will be restricted the first time someone calls, but their password should be "validated" within 24 hrs. which will allow more freedom on the board.

### NO COLLECT CALLS ON THESE ADS, PLEASE

FOR SALE: Collins R-388/51-J3 general coverage receiver. This fine quality Collins receiver is in very good electrical and mechanical condition. Professionally aligned, with manual, \$225.00 plus shipping. Send SASE for photo and answers to your questions. Chuck Klawitter, 4627 North Bartlett Avenue, Milwaukee, WI 53211.

FOR SALE: VIC-20 computer with 27k RAM, MPS-801 printer, 3-slot expander, Froth assembler, games, and all manuals. \$450.00 includes shipping. Jesse Wall, 88 Morningside Drive #1, Akron, OH 44303.

FOR SALE: HQ-140X. Has some scratches on top of cabinet. Recently serviced. Q-multiplier jack added, \$85.00. Heath GD-125 Q-multiplier, could be used with HQ-140X above, \$25.00. HQ-180C, reconditioned, looks good, works great. \$175.00. Prices include UPS shipping. George Sherman, Box 2284, Minneapolis, MN 55402. Phone (612) 588-2618 Thursday through Friday 1800-0400 GMT.

FOR SALE: Galaxy R530 with SC-530 speaker and manuals, \$175.00 shipped UPS. FRENDX, complete 1983, \$5.00. Confidential Frequency List (Fourth Edition); How to Listen to the World (Fifth edition), \$2.50; 1971, 1972, \$3.50 each. How to Improve Short Wave Reception #3; N.R.C. Domestic MW Log 70-71; N.R.C. Latin American MW Log 71, \$2.50 each. Shipping included. Cashiers check or money order, please. Al Drehmann, Route 2, Box 3B, Tryon, NC 28782. Phone (704) 894-3398.

FOR SALE: Yaesu FRT-7700 antenna tuner in new condition. Price \$45.00 including shipping. Almond Merrill, 15 Middle Street, Oakland, ME 04963. Phone (207) 465-2254.

# Shortwave Center



Editor: John C. Herkimer, 3233 East Avenue, Caledonia, NY 14423

If it weren't for DXers like **JERRY BERG** most of us wouldn't get very far in the hobby. After all, he's scrutinized DX programs for us, improved our application of the much-used (and much-abused) WRTH, added new, ground-breaking data to the subject of verifying Chinese regional stations, lead us on nostalgic trips back to stations like Spanish Guinea, staunchly defended the serious DX fraternity from misunderstanding program listeners, and gave us the definitive primer on Latin American DXing in the 1983 WRTH. Since he obviously wasn't doing enough, in July of 1981 he became familiar to us as "JB" in his role as LR-B editor.

Meeting Jerry for the first time leaves you with that feeling that somehow you've known him all along. He's as down to earth as you imagined. But, if you don't know him, he's an attorney and court administrator for the Mass. district court system. Jerry was born in 1943, is married, has two kids, and started DXing in 1958. So who better to talk to (and learn from again) like we have all along? (JH)

## INTERVIEW

### THE SHORTWAVE CENTER INTERVIEW: **JERRY BERG**

*SWC: First of all, how did you discover DXing?*

**JB:** When I was around 13, I built a one-tube radio set from an electronic experimenter's kit, and that's how I first learned about SW. I could hear Moscow, the BBC and a few others. I couldn't even tell what band I was on. From there I "graduated" to several other SW receiver kits. So I came into the hobby basically from the kit-building side.

*SWC: As I recall, you actually were inactive for a number of years before getting back into it. What brought you back?*

**JB:** I was active from early 1958 until 1962, but then college, law school, marriage and "getting started" took over and I was inactive until 1970. By then I was enjoying at least a little free time, and I started thinking about SW again and wondering whatever happened to all those guys with whom I once shared this crazy hobby. I assembled a Heathkit SB-310 and discovered that you could indeed dial right to your frequency, something almost unheard of before. I checked in with a few of the SW clubs and found many familiar names among the still active, and a warm welcome from some hobby friends of years past. The bug had bitten me again, and I've been active ever since.

*SWC: A number of the veteran DXers you learned from and grew up with have dropped from sight. Do you find your interest has diminished in recent years?*

**JB:** My interest has actually increased. I find that, with the country chasing behind me, I enjoy the hobby much more. In the early days I was interested in hearing and QSLing as many countries and stations as possible, but now I prefer to devote more concentration to individual DX targets. There is nothing I like better than finding an unidentified station and going back to it day after day, putting all the clues together until I finally ID it. Also, I have more personal contact with other DXers today than in earlier years, and that adds a great deal to my enjoyment of the hobby. And even though SW broadcasting is giving way to increased AM and FM in many places, there are enough new stations, and old ones that I haven't heard yet, to keep things interesting.

(continued)

SWC: *How much time, per day or week, do you actually spend DXing?*

JB: I probably spend an average of about 12 hours per week listening with varying degrees of intensity. I am an early riser, and so it is quite common for me to spend a couple of hours at the receiver around 0400-0700, before I go to work. This is, in my opinion, the best time for DXing, particularly Latin American DXing. However, my favorite listening time is around 1600-1900, when the Africans can be heard. I often listen during that period on weekends. Conversely, I seldom listen during the 2000-2400 evening period.

SWC: *When you listen are you more of a bandscanner or do you find yourself more target oriented, looking for specific countries or stations?*

JB: Both. Serious DXing requires that you be organized so you can make the most of your time, and so I keep lists of stations I am looking for, frequencies I want to check, etc. I typically check first for stations I want to try for. If I have no luck, or if it is not yet time for a "target" station, I'll scan the 49, 60 and 90 meter bands to see what can be heard. It is only by bandscanning that you find new stations that have not yet been reported by others, stations that are temporarily off the air (perhaps allowing a seldom heard station to come through), etc. I scan with a narrow bandwidth, paying particular attention to hets (stations that are slightly off frequency often turn out to be interesting).

SWC: *How do you reconcile a busy schedule with all the time it takes to DX, write reception reports, update logs, check through bulletins, etc.?*

JB: You have to get into a routine. For example, I always try to get reception reports out as promptly as possible, rather than let them sit around. I also try to be careful to jot down information from DX bulletins that is of interest to me, so I will have it when I need it. I keep a list of "wanted" stations, a file of reported veri signers for stations I'm after, etc. Also, my early morning DXing doesn't interfere with other activities (except sleeping).

SWC: *You seem to favor the old, "boat anchor" tube sets rather than the new state-of-the-art models. What's the attraction?*

JB: I don't favor the older models just because they're old or just because they're tube sets. To me, receiver selectivity is the most important thing when it comes to real DXing. My main receiver is a Hammarlund HQ-180A, modified with a Q-multiplier (and digital frequency display), and I find that the combination of the Q-multiplier with the receiver's notch, 4-position bandwidth filter, vernier tuning and selectable USB and LSB in AM offers tremendous flexibility in digging out and separating weak signals. The new generation of receivers does not offer this kind of flexibility, even with the generally available modifications. The older sets, on the other hand, do not permit easy ECSS reception, but to me ECSS has always been an overated technique anyway, and, not having grown up with it, I don't miss it.

My secondary receiver is also a tube set, a Collins R390A, but I bought it mainly because I just wanted to own one of those great old classics and I happened to find a good one available locally.

Another thing I like about tube sets is their ability to deliver big audio. My radio den is far enough away from the main part of the house that I don't have to worry about disturbing others. This, combined with my dislike of headphones, means that I almost always DX using the speaker, and the tube sets can really fill the room with audio.

But if a new set offering the kind of selectivity and signal handling flexibility that I think is necessary were to come on the market, I would have no hesitation in buying it. (I have two "modern" sets that I use for casual listening, an RF-2800 and an ICF-2001).

SWC: *A few years ago you started to verify the Latin American stations after ignoring them for years. I would guess that the bulk of the stations are behind you now. Do you have any idea as to the reply rate on those first reports?*

JB: If you mean how many LA stations verified without the need for a follow-up, the answer is 46 out of 160 reports (excluding some recent reports that really haven't been out very long), or about 29%. Nothing to write home about, probably about average. The overall QSL rate of the 152 LA reports that I mailed between 1981 and the end of 1983 is 78%, a fair return, I think. But it's getting tougher. When it comes to verifying the Latins, you have to be prepared for the long haul.

SWC: *Did that massive project change your approach to Latin American reports or give you any different insights into the Latin mindset?*

JB: If you DX for a long time, you will eventually hear and verify most of the stations from most other parts of the world that can be heard at your QTH, and there will be fewer new targets to try for. This is what brings many DXers to Latin America; there are hundreds of targets there, many not so easy, and the LA SW scene is changing all the time.

(continued)

When I first started going after LA QSL's, I tended to think that success would depend mainly on the quality of my report: the thoroughness of the program details, plus the inclusion of souvenirs or other inducements that would get the stations to verify; basically, the notion that, if you produce a good reception report, the station will reply.

I am now convinced that, at least as far as Latin America is concerned, this is largely a myth. While program details have to be sufficient to satisfy the station that you heard them, and poor quality reports may (and should) be ignored, the real factors at work are usually perseverance and luck. If you persevere in sending follow-ups, you will get more replies than if you don't. When the station ignores your first couple of reports, it basically comes down to you vs. them and who will give in first. It has been said that "all" stations will give in in the end, and while this is an overstatement, it is true that, if you hang in there long enough, even some of the most recalcitrant stations will respond, out of pity or just to get you off their back or whatever. One DXer recently received a QSL from a tough LA verifier after sending 39 reports. While most of us would have given up long before that, the station did finally verify and that DXer has a QSL that the rest of us are still waiting for. And while you could question whether any QSL is worth the time and money that goes into 39 reports, you can be sure that the owner of that QSL values it pretty highly.

Luck is necessary because whether a station verifies a report or not may depend more on whose desk it lands on than anything else. A new gerente or -- even more important -- a new secretaria may spell the difference between getting a response and being ignored. With each follow-up, lady luck gets another opportunity to give you a break. Something as fortuitous as an announcer looking through the station mail the day your report arrives may mean a QSL after years of silence. I recently received a note from a gal in a nearby Mass. town who was working in public health in Ecuador for the summer and struck up a friendship with the owners of Radio Panamericana. When they found out she was from Mass. they gave her a station pennant and asked her to send it to me when she got back. That's luck (but not enough for a QSL).

SWC: Which LA stations are, in your opinion, the toughest to verify?

JB: I couldn't generalize. Some small stations are better verifiers than big ones. Others may verify for a while and then stop, and start again later. Some of those on my "toughest" list include Peruvians Radio Eco and Radio Andina, Ecuadoreans Radio Popular (4800) and Radio Nacional Espejo, and Venezuelan Radio Bolivar (4770). But I'm sure each of these has verified on the first report for someone.

SWC: You used a unique, shortcut method to write those reports, didn't you?

JB: Well, on the theory that small stations would prefer that we get to the point and not make them wade through a long letter, I had printed up some longish Spanish report cards, bearing my name and address, spaces for time, date, frequency and receiving equipment, and a SINPO grid. I then type an abbreviated Spanish report on both sides of the card. The typed text contains an introduction, a request for a QSL, program details (most of the space is used for that), some brief chit-chat at the end, and that's it. At first I sent only the card, plus return postage, but over time this bare bones report has evolved and I now enclose a pre-printed 2-page letter about myself plus the usual variety of "goodies". Even though alot of stuff goes in the envelope, with this system I can prepare a complete Spanish report in about a half-hour. That is another reason I went to a card system. I just don't have the time or patience to prepare a long, separately typed letter to each station. The card is a good compromise because it is short but it is still typed separately. It's not just "fill-in-the-blanks".

My guess is that the traditional letter approach would produce a somewhat better reply rate, at least if the letter was long and "personal", as opposed to the usual skeletal report letter, but the difference probably would not be worth the extra effort, at least to me.

SWC: Are prepared cards (PPCs) and return postage an essential part of reports or could one do just as well without them?

JB: I think they're important. I enclose a PPC with all LA reports unless I know that a station has its own card. I usually enclose a SASE with the original report, and with every 4th or 5th follow-up. Even if the station doesn't use the return postage, sending it shows that you're considerate of the expense factor.

SWC: You've been LR-B editor since July of 1981. What made you want to be an editor, especially since your so busy with other DX interests?

JB: When you've been DXing a long time and your interests become very specialized, it's easy to forget that there is a broader hobby out there. Editing permits me to keep in better touch with people whom I might not otherwise hear from. Log Report is just a few pages, so it is manageable time-wise. Also, I feel I can do a good job on "B" because that is the range where I do most of my listening. In the early 70's I edited LR when it was typically 14 pages, all done by one editor (using stencils). I did that for about a year but it finally got to me.

(continued)

SWC: *What's your opinion of FRENDX and where do we need to improve?*

JB: FRENDX is the best of the national SWBC clubs, so improving it means making a good thing better. But if I had to suggest an area of improvement, I would say that I would like to see a "musings" section where members could write in with whatever is on their minds about the hobby -- stations they've heard, interesting QSLs, equipment, questions, photos, information about themselves, just a hello, anything. Most of the good overseas bulletins have such sections and they are quite interesting. They make the club a little more personalized and give members a chance to learn something about each other.

SWC: *As an editor myself, I'm always a bit dismayed at the lack of support we get considering the size of our membership. Are we at fault for not providing the incentive and are we not meeting the needs of our members?*

JB: A musings column might encourage more members to participate, but basically I think that only a small percentage of the membership will participate actively, regardless of the club's organization or the contents of the bulletin. This is true of many voluntary organizations. Most hobbyists join NASWA for the information contained in FRENDX, and many may feel that they have little of real interest to contribute. Indeed, that may be true as far as station information is concerned, since many members are basically occasional listeners and do not have the intensity of interest in SW that generates new station data. But NASWA should (and does) welcome these members as much as it welcomes more active individuals. Everyone has to enjoy a hobby in his or her own way. The fact that one person is deeply into the hobby and another just likes listening to Radio Australia once in a while doesn't make one more "right" than the other.

SWC: *Do we need to promote the hobby and, if so, how?*

JB: I don't think we should make great efforts to promote the hobby. In the best of circumstances this is a sedentary, somewhat technical pastime that will never have broad appeal. With the ability to turn on your TV set and see what's happening on the other side of the globe, live, the availability of regular AM and FM broadcasting everywhere, and the impatience of most people with less than perfect reception quality, how many people are going to listen to shortwave? The number who might be attracted to the more specialized area of DXing is even smaller. I think we ought to be content just to service as best we can those who have discovered shortwave and want to belong to a club.

SWC: *Your article "In Defense of DXing" (cf. August 1980 SWC) was a good explanation of the essential differences between serious DXers and so-called program listeners. Four years later, are you still convinced that DXing is here to stay and that international broadcasting is, at best, mediocre?*

JB: Yes, but again, to each his own. I have no problem with someone listening to Radio Tirana day and night if that's what he likes. Personally, though, I find a great deal of the programming on SW pretty poor. Heavy propagandizing, unimaginative program formats and boring subject matters are often the rule, and this is just not the kind of material that is going to appeal to the western ear (or at least my ear). The exceptions are those stations that combine the kind of programming we are used to with good signal quality -- the BBC, Radio Australia, RCI, VOA, etc. But how many of these stations are there? The government control of the media that is typical in most countries results in SW broadcasting that neither entertains nor informs very well. So why listen? The situation is probably improving, but overall you can do better with a book or the newspaper, or even TV.

I think of DXing differently. It's basically you and your receiver vs. the propagation and the QRM, the challenge of hearing, IDing and perhaps QSLing the station rather than concentrating on the programming. But some of the programming, particularly local music, can be pretty entertaining, more so than what you get from some of the international stations. I would rather listen to locally produced huayno music from Peru or hi-life music from Africa than learn about cement production in India. Probably the most interesting stations of all are the local SW stations that broadcast in English and that we can hear fairly well, like Guyana, the Australian locals, the Solomon Islands, etc. You really get the local flavor from these stations. This is true of Latin American stations as well, if you can understand a little Spanish.

SWC: *Here's one everybody asks -- what's your favorite QSL?*

JB: My favorite is from then-500 watter Emissora da Guine in Portuguese Guinea which I heard in 1959. In addition to a QSL, the station returned my tape, over-recorded with greetings, music, chit-chat, all in English. I have always specially prized that one.

SWC: *With the Latin project pretty much accomplished, what's your next frontier?*

JB: You're never really "finished" verifying the Latins, of course, since there are always new ones to hear and old ones to follow-up on. But I guess my next frontier is Brazil. I have heard many Brazilians, but I have just a few veries. I have sent out a few Brazilian reports lately, but I can't seem to build up the same head of steam for the Brazilians that I did for the Spanish-speaking Latins, mainly, I guess, because I can't "get by" in Portuguese as I can in Spanish. But eventually I will get going.

(continued)

SWC: What direction do you think the hobby is going and DXing specifically?

JB: Well, higher power means that more stations can be heard more easily, and easier to operate receivers mean that you don't have to be as technically oriented to listen to shortwave. Overall, though, for the reasons mentioned earlier, I don't see people flocking to shortwave, although I do wonder just who are all these folks that are buying these new shortwave receivers. Is there a whole world of closet SWL's out there, waiting to be discovered? I don't know. We saw a huge explosion in SWLing in Japan for a while, but now it has subsided, much as CB did in the U.S. It's hard to imagine the same sudden burst of SW activity in the U.S. I think SWLing will continue to be a hobby enjoyed by relatively few.

As far as DXing is concerned, it will always appeal to some hobbyists, but I believe the ranks of the DXers will continue to be small. The fact that our numbers are limited is not all bad, however, as it contributes to closer contact among those who are active, and that in turn makes for a more enjoyable hobby. But the absence of large numbers of DXers also means that receiver manufacturers are going to continue to produce consumer-oriented SW receivers rather than high performance DX machines. Overall, I think things will continue along pretty much as they have.

SWC: Any parting advice for would-be DXers and fans of Jerry Berg?

JB: My advice to would be DXers is basically that "practice makes perfect". Developing one's DXing skills is almost entirely a matter of experience -- time spent at the dials -- and not receiving equipment. So don't let the absence of a top performing receiver stop you. A good DXer with an inexpensive receiver can DX rings around a novice with the best equipment.

As for fans of JB, I hope they'll both start contributing to LR-B.

SWC: Thanks, Jerry, for sharing those thoughts with us, and good luck wherever the hobby takes you. You're definitely a team player! (JH)



At left:

The man.... The legend....

Jerry Berg at the dials of the HQ-180A.

He inscribes this photo:

"Would you buy a used car from this man?"

## Glad Tidings

**CONGRATULATIONS!** The South Florida DX ranks have swollen by one more with the arrival of DANIEL SCOTT REINSTEIN on November 5, 1984 at 7:55 p.m. His proud Dad is STEVE REINSTEIN (you know, the one that hears -- and QSLs -- all those Bolivians) and I'm happy to report that the family is fine! (JH)

No man is really happy or safe without a hobby, and it makes precious little difference what the outside interest may be ... anything will do as long as he straddles a hobby and rides it hard.

SIR WILLIAM OSLER,  
Aphorisms from His Bedside Teachings  
and Writings

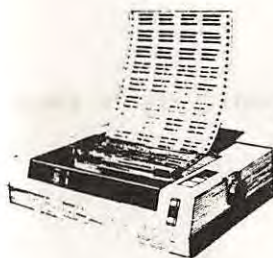

# Computer Corner

Editor: Bill Cole / 107 Charles Street / N. Cape May, NJ 08204

NASWA Log Report, which appeared in the April issue, netted me quite a few letters with suggestions and comments. After I reviewed all the suggestions, I realized that this Program didn't do anything that a reasonably dexterous Person with a typewriter couldn't do. Log Processor incorporates many user suggestions to go beyond being just an electric typewriter. It contains features found in a word Processor hence the name.

Log Report performed one function. You typed in data and it was printed in the NASWA format. Log Processor performs 5 separate functions: 1. Prepare up to 10 loggings; 2. Print the loggings (10 fill a page); 3. save the loggings on tape or disk; 4. recall the loggings from tape or disk; 5. display the loggings on video screen.

Type in the Program and SAVE it to tape or disk. Enter your name in G\$(Y) line 55 and your name and address in W\$(Y) line 102. You will have to change the length of Z\$(Y) in line 101 to accommodate for changes in the length of 102. Run the Program. It is user friendly, all you have to do is follow the Prompts.

```
10 POKE53280,1:POKE53281,1:GOTO160
15 PRINT"Q":INPUT # OF LOGS TO BE ENTERED (MAX. 10)":Z:IFZ>10THEN15
20 FORY=1TOZ:PRINT"Q"TAB(15)"LOGGING #""Y":PRINT:SW=1
22 GOSUB501:OPEN3,0
25 PRINT"#####"TAB(11):INPUT#3,A$(Y):IFLEN(A$(Y))>20THEN25
27 PRINT"#####"TAB(9):INPUT#3,B$(Y):IFLEN(B$(Y))>20THEN27
29 PRINT"#####"TAB(9):INPUT#3,C$(Y):IFLEN(C$(Y))>20THEN29
30 PRINT"#####"TAB(12):INPUT#3,D$(Y):IFLEN(D$(Y))>11
32 PRINT"#####"TAB(31):INPUT#3,H$(Y):IFLEN(H$(Y))>8THEN31
33 PRINT"#####"TAB(10):INPUT#3,E$(Y):IFLEN(E$(Y))>20THEN33
35 PRINT"#####"TAB(10):INPUT#3,F$(Y):IFLEN(F$(Y))>79THEN35
55 G$(Y)="COLE":PRINT:PRINT:PRINT"ANY MISTAKES? Y=YES N=NO":CLOSE3
60 GETPK$:IFPK$=""THEN60
65 IFPK$="N"THENNEXTY:RETURN
70 IFPK$="Y"THENPRINT"Q"TAB(12)"DO LOGGING #""Y"OVER":PRINT:GOTO22
75 GOTO60
100 X$="#####":Y$=" LOG REPORT #"
101 Z$="#####"
102 W$=" WILLIAM COLE, 107 CHARLES ST, N CAPE MAY, NJ 08204 #"
105 PRINT"Q":PRINT"PRINTING LOGGINGS.":FORY=1TOZ
115 O=80-LEN(F$(Y)):IFO<2THENO=2
120 OPEN1,4:PRINT#1,X$:PRINT#1,Y$:PRINT#1,X$;
125 PRINT#1,"(1)"A$(Y)SPC(2)"(2)"B$(Y)SPC(2)"(3)"C$(Y)
130 PRINT#1,"(4)"D$(Y)SPC(2)"(5)"E$(Y)SPC(2)"(6)"F$(Y)SPC(0);
135 PRINT#1,"(7)"G$(Y)SPC(2)"(8)"H$(Y)
140 PRINT#1,Z$:PRINT#1,W$:PRINT#1,Z$:PRINT#1,PRINT#1,CLOSE1:NEXTY
145 PRINT"Q":PRINT"LOGGINGS PRINTED."
150 PRINT:PRINT"PRESS ANY KEY."
155 GETA$:IFA$=""THEN155
160 PRINT"Q":PRINTTAB(13)"LOG PROCESSOR":PRINT
200 PRINT"HERE ARE";Z;"LOGGINGS IN MEMORY. PICK"
205 PRINT"THE PROCESSING YOU WISH FROM THE MENU.":PRINT:PRINT:PRINTTAB(18)"MENU"
210 PRINT:PRINTTAB(9)"1"PREPARE NEW LOGGINGS"
215 PRINT:PRINTTAB(9)"2"HARDCOPY LOGGINGS"
220 PRINT:PRINTTAB(9)"3"SAVE TO TAPE/DISK
225 PRINT:PRINTTAB(9)"4"RECALL FROM TAPE/DISK
230 PRINT:PRINTTAB(9)"5"DISPLAY LOGGINGS"
230 GETPK$:IFPK$=""THEN230
235 IFPK$="P"THENCLR:GOSUB15
240 IFPK$="H"THEN100
```

```

245 IFPK$="S"THENGOSUB300
250 IFPK$="R"THENCLR:GOSUB400
251 IFPK$="D"THENGOSUB500
255 GOT0160
300 PRINT"J":INPUT"FILE NAME TO BE SAVED";FI$:PRINT:PRINT"PRESS KEY FOR WRAPE OR
R WDISK."
305 GETPK$:IFPK$=""THEN305
310 IFPK$="T"THENPRINT:GOT0325
315 IFPK$="D"THENPRINT:GOT0330
320 GOT0305
325 OPEN2,1,1,FI$:GOT0335
330 OPEN2,8,2,"0:"+FI$+",S,W":PRINT
335 PRINT"SAVING LOGGINGS."
340 FORY=1TOZ:PRINT#2,A$(Y):PRINT#2,B$(Y):PRINT#2,C$(Y):PRINT#2,D$(Y)
341 PRINT#2,E$(Y):PRINT#2,F$(Y):PRINT#2,G$(Y):PRINT#2,H$(Y):NEXTY
342 X=999:PRINT#2,X:PRINT#2,X:PRINT#2,X:PRINT#2,X:PRINT#2,X:PRINT#2,X:PRINT#2,X
343 PRINT#2,X:PRINT#2,X
345 PRINT"J":PRINT"LOGGINGS SAVED.":CLOSE2
350 PRINT:PRINT"PRESS ANY KEY."
355 GETPK$:IFPK$=""THEN355
360 RETURN
400 PRINT"J":INPUT" # OF LOGS TO BE RECALLED (MAX. 10)":Z:IFZ>10THEN400
405 PRINT"J":PRINT"NAMES OF STATIONS TO BE RECALLED?":PRINT:FORY=1TOZ
410 INPUTCC$(Y):NEXTY:PRINT:PRINT
415 INPUT"FILE NAME TO RECALL";FI$:PRINT:PRINT"PRESS KEY FOR WRAPE OR WDISK."
420 GETPK$:IFPK$=""THEN420
425 IFPK$="T"THENPRINT:GOT0440
430 IFPK$="D"THENPRINT:GOT0445
435 GOT0420
440 OPEN2,1,0,FI$:GOT0450
445 OPEN2,8,2,"0:"+FI$+",S,R":PRINT
450 PRINT"READING DATA.":FORY=1TOZ
455 INPUT#2,A$:INPUT#2,B$:INPUT#2,C$:INPUT#2,D$:INPUT#2,E$:INPUT#2,F$
456 INPUT#2,G$:INPUT#2,H$:IFVAL(A$)=999THEN495
460 IFCC$(1)=C$THEN485
461 IFCC$(2)=C$THEN485
462 IFCC$(3)=C$THEN485
463 IFCC$(4)=C$THEN485
464 IFCC$(5)=C$THEN485
465 IFCC$(6)=C$THEN485
466 IFCC$(7)=C$THEN485
467 IFCC$(8)=C$THEN485
468 IFCC$(9)=C$THEN485
469 IFCC$(10)=C$THEN485
471 GOT0455
472 NEXTY:PRINT"J":PRINT"LOGGINGS RECALLED."
473 PRINT:PRINT"PRESS ANY KEY."
475 GETPK$:IFPK$=""THEN475
480 CLOSE2:RETURN
485 A$(Y)=A$:B$(Y)=B$:C$(Y)=C$:D$(Y)=D$:E$(Y)=E$:F$(Y)=F$:G$(Y)=G$:H$(Y)=H$
490 GOT0472
495 PRINT"J":PRINTCC$(Y)" NOT IN FILE":Z=0:GOT0473
500 FORY=1TOZ:SW=0:PRINT"J"TAB(15)"LOGGING #Y":PRINT
501 PRINT"FREQUENCY: "A$(Y)
505 PRINT:PRINT"COUNTRY: "B$(Y):PRINT:PRINT"STATION: "C$(Y):PRINT
510 PRINT"TIME (GMT): "D$(Y):PRINT"J"TAB(25)"DATE: "H$(Y):PRINT
511 PRINT"LANGUAGE: "E$(Y):PRINT:PRINT"DETAILS (MAX. 79 CHARACTERS)":PRINTF$(Y)
515 IFSW=1THENRETURN
520 PRINT:PRINT:PRINT"PRESS ANY KEY."
525 GETPK$:IFPK$=""THEN525
530 NEXTY:RETURN

```

I want to thank all the members who have written with words of encouragement, criticism, questions and suggestions. Keep the cards and letters coming in folks; I will answer here as space allows. If I don't answer in CC, then expect a letter.

So far CC fans are falling into two categories. Those with some computer proficiency sending programs & articles and those new to computing who need a helping hand. Another trend has appeared. Computer novices say that their DXing suffers while they are learning this new technology. Most also return to DXing after a period of time. I would like to suggest that probably the best way to get these "hackers" back to their receivers is to help them develop the computer skills they want and need.

In October's CONTACT, Don Moore suggested a corps of Big Brothers to help novice DXers. I would like to suggest a corps of Computing Big Brothers to help novice "hackers" learn and get them back into their DXing. Anyone wanting to correspond with other Computing DXers may send their name & address, type computer, computer needs or skills and DX specialty. I will develop a listing and circulate it to all interested.

NEXT MONTH: January's CC takes a look at TARGET FILE, commercially available shortwave software for Atari.

---

## CONTACT

---

Editor: Andy Robins, 223 North Shore Drive, Apt. 211-S, South Haven, Michigan 49090

---

The plight of the newcomer still dominates the minds and typewriters of those contributing to "Contact". John Tuchscherer in Neenah, Wisconsin, writes:

"I read with much interest the recent 'Contact' items dealing with a lack of information for the newcomer to the radio hobby. There is a surfeit of material available at public and college libraries covering radio theory, antennas, propagation, history, etc. Those who will take the time to study can get a good background this way. However, there is no reason why each newcomer cannot have personal help. We've got several thousand shortwave listeners/DXers, plus more than 400,000 hams in the U.S., and I'm sure 99% of them would be glad to help answer their questions. Many amateur radio clubs run classes during the winter months. For the serious beginner, I highly recommend attending such classes."

Good advice from a true NASWA veteran. John Bellantoni of Ithaca, New York, says the shortwave hobby can appear forbiddingly complex to the uninitiated:

"I have seen the plight of the novice in every area of the hobby. Indeed, when first confronting the RF world, one is often intimidated and confused by the jargon and technical aspects. The recent letters in 'Contact' have highlighted this problem. My intention is to help clear up the problem by explaining how to approach the hobby. I will put to rest the controversy about columns designed for the novice in the process."

"After turning the radio on for the first time and listening, the newcomer usually has a thousand or so questions that need to be answered. What the novice SWL needs is information. One of the best sources for this is the receiver itself: you can learn a lot about the hobby by tuning in the larger broadcasters. But usually this is not enough."

"Start from the basics and work up. Write to radio stations you hear and get on their mailing list. Write to various radio clubs. Check out the magazine racks for popular publications catering to the radio hobby. Find books about basic electronics at the local library. Don't select a book or magazine just because the title has something to do with radio. Flip through it and check to see if you understand the contents. Material that's over your head is useless and may scare you right back to watching TV. Research takes work but the information is out there if you're willing to dig for it."

"With learning of this kind the 'inverted triangle' model holds. This means: the more you know, the more you can learn. This is about all there is to it. Shortwave listening is a simple hobby; one can enjoy it without advanced knowledge. The key is to start with the basics and enjoy yourself."

"A column specially designed for novices is out-of-place in FRENDX and other hardcore DX journals. These are devoted to the latest in the hobby and are aimed at the experienced reader. This is true in any subject. To learn the basics of shortwave listening, one should turn to a basic reference like Ed Shaw's 'DXing According to NASWA,' and similar books--not a periodical filled with articles on the latest longpath catch of an African local and how to tune up your new phase-locked exalted-carrier detection system."

Thanks John, although I imagine many will take issue with your assertion that there is little room for the novice in the pages of FRENDX. We were all beginners once. By the way, John is also known in the ham community as WB1ALZ.

One NASWA member who would definitely like to see a novice's column in FRENDX is Dennis Richards of New Haven, Connecticut:

"I wholeheartedly agree with Mr. Joe Freeborn about a beginner's column and would like to see this happen. I would also be willing to help out in any way possible. I don't have that much experience as I've only been involved in the hobby for about two years, but my membership in NASWA has been a great help."

Our last letter this time comes from Kraig Krist in Falls Church, Virginia:

"I read with interest the comments and viewpoints in the October 'Contact.' I agree that it is hard for a beginner to catch on in our hobby. Meter, MHz, kHz, UTC, GMT, IRC, SINPO, etc., pose many puzzles for the novice. I remember how I stumbled toward my first QSL. My receiver was the dial type as I'm sure most were until a few years ago. A station would announce they were broadcasting on, say, 9575, 9590, and 11960 kHz. My dial would be resting on the 9MHz position but I really didn't know the exact, or I should say correct frequency. At times I would get frustrated and only report that I heard a station on a particular meter band. Some stations accepted this but many did not.

"GMT/UTC gives people a lot of trouble. Once I understood the GMT concept (this was before UTC) I made a three-column list. The first column was the GMT hour, the second EDT, and the third EST. A tack and strip of paper would cover up either of the last two columns, whichever wasn't in use that month. This proved to be a big time saver and an easy way to learn GMT.

"SINPO is another problem area. Some claim the Overall number cannot be greater than the lowest number already assigned to S, I, N, or P. Others say Overall should be the average of the others. The whole process of assigning signal ratings is a difficult thing all by itself. If someone listens most to low-powered domestic stations, they might rate others they hear more highly than they should. Likewise, someone who usually tunes in the powerhouses like Radio Moscow and the BBC might rate smaller stations more poorly than they deserve."

Kraig generously offers to answer questions if you will only include a SASE. His address is: 6200 Wilson Blvd., Apt. 1019, Falls Church, VA 22044.

Still no response on our poll of the world's worst shortwave stations and programs. Consider it a creative opportunity to wield the corrective wand of criticism.

I join in hoping that Bill Whitacre and his bride Paula find nothing but the best. To borrow from ABC's Paul Harvey, this is "Closed Circuit": Bill, I haven't forgotten you. I was with you in spirit, if not in person. All the very best. Bill and I kept bailing water out of a sinking ship called the Great Lakes DX Association a millenium ago. The GLDXA is now fondly recalled by some; why I have no idea.

As always, your letters and comments are welcome. In fact, without them I wouldn't have a column to write.



Editor: James G. Herkimer, 3255 South Drive, Caledonia, NY 14423

## Antenna Phasing Systems by Mark Connelly, WAIION

Phasing, for the uninitiated, is the production of a phase shift between the tuned signals from two Antennae: the two signals are then electrically added or subtracted from each other to produce a null of the dominant (unwanted) station on a given channel to allow reception of subdominant stations covered by slot. The end result of such nulling is comparable to that obtained by looping. Unlike looping, phasing can more often provide reception of stations in the same direction or in the opposite direction (180 degrees) of the unwanted station that was nulled.

In recent years, phasing has become popular with EBC DXers in North America, and they have done the most research and development in this area, particularly in the refinement of techniques previously applied to parallel Beverage wave antennas. The result of this work is that phasing, using these techniques, is not limited to Beverage length (1000 feet or greater) wires, or to EBC frequencies. Therefore, the circuit descriptions in this article are based on EBC designs, but will include information on application for the 90 and 60 meter tropical SWBC bands.

Figure 1 shows the circuit for a simple phasing unit for EBC use, using a pair of Beverage length aerials:

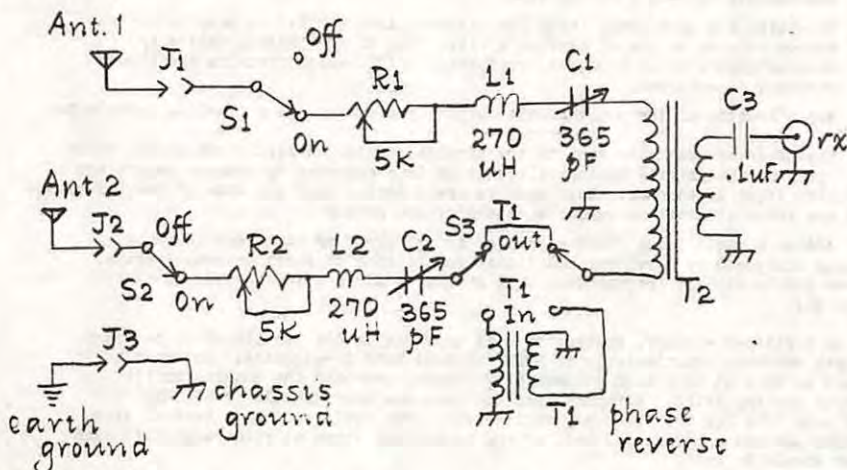

T1 is a phase-reversing toroidal transformer consisting of a 25 turn bifilar winding evenly spaced, occupying 1/2 of a Miller F-87-1 or Amidon FT-82-77 core. (FT-82-61 for tropical bands)

T2 is a toroidal RF transformer consisting of a 25 turn trifilar winding; windings are evenly spaced, occupying 2/3 of a Miller F-87-1 or Amidon FT-82-77 core. (Amidon FT-82-61 core for tropical bands)

Components J1, S1, R1, L1, and C1 are defined as Line 1.

Components J2, S2, R2, L2, and C2 are defined as Line 2.

The phaser is operated as follows:

1. Peak Line 1.  
Set R1 to zero ohms  
Set S1 to On, S2 to Off, S3 to T1-out. Adjust C1 for maximum signal at frequency of interest.
2. Peak Line 2.  
S2 On, S1 Off. Leave C1, R1, and S3 in previously set positions.  
Set R2 to zero ohms. Adjust C2 for maximum signal at frequency of interest.
3. Null  
Put both S1 and S2 to On. Flip S3 between T1-In and T1-Out positions. Leave S3 in the position yielding the Lower signal level of the "pest" station to be nulled. Increase R1 to see if a "dip" (point at which turning the control either clockwise or counter clockwise will further decrease the level of the "pest" station). If a "dip" occurs, leave R1 at this position, otherwise, return it to zero ohms. Do the same with R2 (see if a "dip" occurs). Then, offset C1 to enhance the dip. Do the same with C2. Finalize the null with slight adjustments of R1, R2, C1, and C2. Subdominant stations should now be audible, as well as formerly-slopped adjacent-channel stations.

An added bonus to the nulling process is that any man-made noise appearing in the system is also nulled. This allows DXing to be accomplished in areas plagued by interference from TV's, light dimmers, etc.

Improvements/Modifications to the basic phasing unit:

1. Use of a multipole rotary switch to incorporate the functions of S1, S2, and S3, minimizing the number of switching manipulations required.
2. Use of a switchable inductance scheme in each line leg to allow peaking of a variety of antenna lengths. Small, choke-type inductors are ideal for this application. Values of 22, 10 and 4.7 uH are suggested for tropical SWBC use.
3. Adding a parallel trimmer capacitor and series trimmer potentiometer in each line leg will facilitate finalizing the null. The trimmer pot should be non-inductive, i.e., a carbon type.
4. Provision for additional input for either a loop (active or passive) or an active whip to be phased against a wire. One of the phasing unit's L/C combinations will be bypassed, preferably L2/C2, which contains the phase reversal transformer.
5. Amplification of the phasing unit output, preferably via a tracking preselector.

Experimenters may also want to try parallel tuning of L1/C1, and L2/C2, which will provide predictable tuning, i.e., it is less affected by antenna length and receiver input impedances. Best results are obtained when one side of the inductance and the rotor side of the variable capacitor are grounded.

Adding a small value fixed capacitor in the 22-47 pF range may increase tuning sharpness by providing additional capacitance to short antenna lengths. (less likely at SWBC frequencies) This should be added after the pot in each line leg.

As mentioned earlier, phasing of wire antennas is not restricted to Beverage length antennas, particularly at SWBC tropical band frequencies. Antennas as short as 15 feet have been successfully phased, provided the phasing unit's output was amplified. Without amplification, the wires should be at least 1/2 wave long for the frequency of interest. For best results, a vertical wire phased against a horizontal one, or two horizontal wires at right angles to each other should be used.

---

This article was edited from a series of articles by Mark Connelly, W4LION, which originally appeared in DX News, published by the National Radio Club, and DX Monitor, published by the International Radio Club of America, and is used by permission of the author.

Mark adds: "Phasing, like looping, provides the deepest nulls when signal vertical and horizontal arrival angles are not fluctuating greatly in short-term real time. It is on the frequencies below 5 MHz that these techniques have traditionally exhibited their greatest worth."

Many thanks, Mark. See you next month! 73- Jim

## What one can do with SWL

## DX info service for \$1

STARTING *Radio Vibes* is welcomed by most keen DXers and SWL's. I, for one, give my full support. Malaysia, being without a DX Club, should benefit from *Radio Vibes*, as the column brings together people interested in SW and DXing to exchange news and ideas.

First, I would like to call on a *Radio Vibes* reader, whose letter was published in May. He mentioned he was not able to get the addresses of Radio Berlin International and Radio RSA (South Africa). Here

they are:

© Radio Berlin International, Nalenestraasse 18-15, Berlin 116. German Democratic Republic of Germany; and

© Radio RSA (Republic of South Africa), P.O. Box 4556, Johannesburg 2004, South Africa.

Next, I suggest that *Radio Vibes* start a weekly feature on the problems of DXing, like how to put up SW antennae to improve reception, etc. In this way, we can enable more people to get interested in SWL. I can help by providing some information on Antennae in future letters. I am sure other experienced DXers can come forward to offer their help.

By the way, The Far East Broadcasting Company in Malacca is also offering a free booklet on SWL to listeners who write to them.

SWL is not only confined to international stations. If the listener is equipped with a good receiver and antenna and his receiver has facilities to receive single side band (SSB), he can also tune in to the conversations of the amateur operator channels.

Malaysian amateurs operate at around 6.30 pm local time on SSB on the frequency of 7.040 mhz. Although they use only 20 to 60 watts, receivers like the Sony 7600D or the National DR31 or the Philips AL 990 are sufficient as they all have a BFO (Beat Frequency Oscillator) to demodulate the SSB signals.

Some of these hams on 7.040 MHz daily are the 9M2 Gang, i.e. the stations with their official call sign, like 9M2FK (Fox Kilo) in Penang, 9M2SE (Sugar Baker) from Ipoh, 9M2BR (Buck Rogers) 9M2DW (Disco Woman), just to name a few. All these have their own call signs with attractive names.

Besides these, there are also the International Time Signals Stations giving exact time and frequency for time adjustments and frequency adjustment and navigational purposes. The station can be received 24 hours on the frequencies of 16.000 MHz, and 10.000 MHz.

With the SSB modes, we can also listen to ship communications as well as aeronautical and navigational radios on air plane positions and altitude. These stations operate on 858 at 8.940 on L.S.B. (lower side band).

Before I end, I would like to share a tip with DXers and SWL here. In case they still do not know, the Sri Lanka Home Service (Sri Lanka Broadcasting Corporation) commercial service is on the air from 3 pm local time till midnight on the frequency of 4.140 (60 metres). Why not tune in for a try?

Cameron Highlands, C.A.



## Keen to join a DX club?

□ I HAVE something to share with SW listeners who are keen to join a DX club. Recently, I received a letter from Mr. Arthur Ward of the World DX Club (WDXC) in the United Kingdom, informing me that the club is ready to help Malaysian DXers who are interested in joining its membership.

All one has to do is to cover the surface subscriptions to the club, which is £3 (about M\$16.50), and members of the WDXC in United Kingdom will help to support the membership.

Members of the WDXC will receive the club's monthly publication, called *Contact*, which features many interesting articles on DX-ing. Those who would like to take up this offer can write to Mr. Arthur Ward, 17 Motspur Drive, Northampton, England NN2 6LY.

P.H.  
Kuala Lumpur.

## Calling DXers, let's have a club

□ IN the recent 18th EDXC conference in Sweden, I was surprised to hear that Asia was represented by Sri Lanka and Korea.

Why doesn't Malaysia have a DX club? It's about time someone thought seriously about forming one. I heard the conference details on Radio Australia's Talkback, a programme for DXers. There were only 13 clubs present.

Perhaps Malaysian DX-ers can make it to next year's conference in Madrid from May 24 to 27.

From recent newspaper cuttings I have on *Radio Vibes*, there are many DXers interested in forming a DX club here. I'm sure it is no easy task but someone has to start it, so DXers, let's begin.

I hope that other DX-ers will voice their support for a Malaysian DX club.

DX-TER B.Q.S.A.,  
Kluang.

## Mocking the Japanese...!

□ HAVE you ever tuned in to RMK's 'Mo-shi-Moshi' programme at 5.30 pm? So you thought it was cute. And you liked it.

I think it shows absolute disrespect of the Japanese language and makes a mockery of it! How very sickening!

The Malaysian Government can say a lot for the preservation of culture and tradition, but with due respect, it seems to be encouraging the Ministry of Information to mock a foreign language by using the Japanese language as a plaything. And Malaysians in Kuala Lumpur are enjoying and supporting every mo-

ment of such ignominious idiosyncrasy.

It is the normal habit of Malaysians to mock the pride of a race — its identity and its language? Must the Japanese people/Government present an official protest and demand an apology before the Malaysian DJ on RMK performs his duty with some maturity, responsibility and dignity?

OFFENDED  
JAPANESE,  
Kuala Lumpur.

Here's an interesting item RALPH PERRY found in a Malaysian newspaper recently. Ralph hasn't spotted anything else yet, but he's watching for us.

Before I close I should note that this column has been entirely created using a phototypesetter, a computer generated keyboard used for commercial typesetting. It's been something I've wanted to do for some time. The type style is Palatino.

I hope that everyone has an enjoyable Christmas holiday and a healthy and happy New Year!

73.

*Harv*

HERK

Compiled by Roger Legge

A considerable number of frequency changes were made on the winter schedules, differing from the information available at the time the schedule printed in the November Frendx was prepared, mainly moving to lower frequencies because of the current declining phase of the sunspot cycle.

Following are the revised frequencies of transmissions on which added changes were made, with new frequencies underlined:

To Eastern & Central North America

		<u>Revised frequencies</u>	<u>Freqs. dropped or not used</u>
1100-1300	Moscow	6115h, <u>15135</u> , <u>15455</u> , <u>15475</u> , <u>17810</u>	15100, 15150
1200-1255	Peking	<u>6160</u> , 9820	11650
1235-1245	Athens	11645, 15630, <u>17565</u>	9815
1300-1500	Moscow	11840h, 15135, 15150, <u>15455</u> , 15475, <u>17810</u>	15100, 15485
1400-1430	Su Oslo	<u>15305</u>	15175
1500-1700	Moscow	<u>11840h</u> , <u>11860</u> (from 16), <u>15455</u> , 15475	15100
1600-1700	Paris	15315, <u>15435</u> , 17620	21685
1700-2000	Moscow	11840h, 11860 <u>to 19</u> , <u>7335</u> (from 18) <u>7165</u> (from 19)	7440, 9520, 9710, 9765
2000-2030	Jerusalem	<u>7412</u> , 9440, <u>9815</u>	11655, 12025
2130-2200	Sofia	<u>7115</u> , 9700, <u>9665</u>	9745
2200-2300	Ankara	<u>9560</u>	9660
2200-2300	Moscow	7115, <u>7165</u> , <u>7195</u> , <u>7335</u>	7215, 7440
2230-2300	Jerusalem	7412, <u>9425</u> , 9440, 9815	11655
<del>2300-2350</del>	Tripoli	11815	ex 2200-2250
0000-0100	Sofia	9700, <u>11725</u>	6070
	Tokyo	<u>9645</u> , <u>11710</u>	9675, 11860
0000-0300	Peking	<u>9880</u> , 11860 (to 02)	9860, 11650
0015-0100	Berlin	<u>6080</u> , 9730	11975
0030-0100	Kiev	7205, 9685, <u>9750</u> , <u>11790</u> , 15240	7135, 17870
0100-0450	Havana	<u>6140</u>	6090
0130-0145	Athens	<u>6205</u> , 9420, 11645	7370, 9865
0130 -0400	Moscow	<u>7165</u> , <u>7195</u> added	7185, 7440 out
0200-0500	Quito	<u>6140</u> , 9745	15155
0230-0315	Berlin	<u>6080</u> , 9730	11975
0300-0330	Kiev	<u>7205</u> , <u>9750</u>	7135, 7215
0300-0350	Ankara	<u>9560</u>	9660
0340-0350	Athens	<u>6205</u> , 9420, 11645	7370, 9865

To Western North America

1535-1545	Athens	11645, 15630, <u>17565</u>	9815
1700-2000	Moscow	7290, <u>9580</u> , <u>12010</u> , <u>12050</u>	9795, 11790
2300-2330	R. Vilnius )		
0030-0100	R. Kiev )	<u>11790</u> , 15100, 15240	17870
0300-0330	R. Kiev )		
0355-0400	R. Yerevan )		
0000-0300	Peking	<u>9880</u> , 11860 (to 02)	9860, 11650
0100-0450	Havana	<u>6140</u>	6090
0130-0145 )	Athens	<u>6205</u> , 9420, 11645	7370, 9865
0340-0350 )			
0200-0500	Quito	<u>6140</u> , 9745	15155
0300-0400	Ankara	<u>9560</u>	9660
0330-0600	Havana	<u>6090</u> scheduled, but still on 11760	
0430-0500	Vienna	<u>5945</u> , <u>9635</u>	9770
0500-0600	Tokyo	<u>15300</u>	9645



(LN in last month's FRENEX should've been headed NOVEMBER 1984)

# Listeners Notebook

GLENN HAUSER, Box 490756, Ft Lauderdale FL 33349

**PROPER CREDIT** Other publications, and broadcasters, may use material from LN, provided due credit is rendered to the original reporter and the NASWA Listeners Notebook. This courtesy does not extend to closed organizations which do not allow reciprocal access to their publication. BBC Monitoring Service items (designated WBI for World Broadcasting Information) are copyright and may not be reproduced without BBCMS permission. The most important items have been broadcast immediately on WRNO WORLD OF RADIO or RCI SWL DIGEST, not otherwise mentioned herein. All contributions to LN are gratefully received, but your editor cannot promise a personal reply because of severe time constraints. Material for LN should be marked as such each time (not just on the envelope), as input for other gh outlets also comes to Box 490756. Reports to gh should not be cut into little strips. It also helps if you use one side of paper only, and do not mix LN items with other correspondence. All times, dates and days are day/month GMT, u.o.s. Please do not ask me for advice on receivers or other equipment. Thanks (gh)

**AFGHANISTAN** For some weeks now, xmtr normally carrying on 6230 R Afgh 2nd Pgm in natl minority langs, ES pgms to SAs, and anti-Iran govt & pro-Tudeh Party R Iran Tolers, has been somewhat unstable and hrd intermittently on fqs arnd 6085 or 6095 (WBI 25/10) R Afgh ES in EG 1900-1927 now hrd on 7310 w/some jamming // 9665, 11805 (Arthur Cushen, NZ, RN Media Network 1/11) R Afgh EG at 1920 hrd on 5905 via USSR xmtr (RNMN 8/11) more, Last Minute, Last Minute Info (IMLMI)

**ANGOLA** During the 4/11 CANAVDX pedition at Cañaveral Nat'l Seashore, FL, most of the guys cleaned up on Angolans; I mainly hrd Luanda 5335; and around 0500, Benguela on 5043.5 w/IS, PT anmt mentioning "Portuguesa" several times, IS again, ID, fqs, giving date of 4 novembro, pgm summary for entire day including numerous RNA relays

**AUSTRALIA** Since July, RA has been conducting tests from Perth to Au research (gh) bases in Antarctica via a 10 kW xmtr, 0300-0500 Fri only, on 15410. "Calling Antarctica" at 0300 & 0400, and spl FR pgm 0430-0445 (taped in France for the French Bases) --ant is 207° rhombic which until 1983 was used in opposite direxion for radio-phone svc to Derby WA. Lyndhurst: the 30 kW PEP USB feeder on 12290 intended for Carnarvon ended 20/9/84. Main purpose was backup feed of Indo pgm; coaxial bearer between Perth and Carnarvon has been cut several times since 1975. However, in future, Darwin'll be carrying IN pgm instead; main users of feeder recently've been DXers in Eu & Au. This practice is not really encouraged by RA, in view of DOC's firm policy against OOB being. Over next year, feeder'll only be onswitched when required. From 1986, Darwin & Carnarvon'll rx pgms via AUSSAT, while terrestrial linx'll provide backup. Lyndhurst [Vic] stn'll be closed in late 1985 or early 86. Apart from the two 30 kW ISB xmtrs, there are eight 10 kW DSB units being RA, ABC domestic SW, and VNG. Most of these'll be transferred to other existing sites, incl Shepparton, and Liverpool (Sydney) (Robert Jones, Nov ADXN) RPH--Radio for Print Handicapped stns currently above 1600 kHz may have to move even higher, or below 1600 (Francis, ADXN) RA reported 30/10 that the Fedl Minister for Comms had re-opened RA's xmtr stn in Darwin for being to As. Said govt'd spent 10M\$A+ over past 3 yrs replacing, upgrading eqp destroyed during cyclone Tracy 12/74. Stn now resumed being 16hpd to As after sevl weeks preliminary bcs to test eqp (WBI 8/11)

**BANGLADESH** R Bangladesh new sked as monitored 21/10: AR 1600-1630 7110 9855. BG 0830-1000 17670 21640, 1630-1800 7110 9855. EG 0800-0830 17670 21640, 1230-1300 on 15180 17670, 1815-1915 5915 7355. NP 1315-1345 7105. UD 1400-1500 7145 9640; HD not monitored so far (Roger Tidy, UKOGBANI, WRTVH Newsletter [NL]) [While we agree wholeheartedly with NL's sentiments about quotation and proper attribution, it has long been std practice in LN for attribution to immediately follow each item, in (). My ing some attributions to the beginning would be inconsistent here & confusing -gh] On RCI SWL Digest 4/11, Noel Green gave the same sked, but also 9775 for 1315-1345 Nepali, and Hindi 1530-1600 on 7195 9590 (100 kW); also said news reported two 250

kW xmtrs commissioned 17/10 (gh) WBI also reprints from R Bang the same sked 1/11, adding that the 0800-0830 EG is called "Voice of Islam"; Press Reviews are on Thursdays at 1245-1250 & 1835-1840 (gh) Bang nx agcy BSS reported that two 250 kW SW xmtrs and aerial system inaugurated in Savar nr Dhaka 17/10; set up w/French assistance, capable of being pgms around clock. They'd be used mainly for R Bang ES. 20/10 & 21/10, RB hrd at 1630 on 9855 & 7110 asking listeners to write to Dir, ES, RB, P O Box 2204, Broadcasting House, Dhaka (WBI 25/10) Two new SW xmtrs at Kabirpur commence full svc from 17/10 for ES. 'll improve reception in ME/NAF/parts of USSR/FE. (Bang TV news 17/10 via Prodyut Banerjee, Calcutta, Asian DX Review) Where?

BHUTAN [cf last month's LN; a mistake we suspected is now confirmed & corrected -gh] NYAB on new 3395 in EG 1330-1400 is Wed & Fri (Prodyut Banerjee, ADXR Oct) However, we now have another contradiction: (gh) This rarest of countries on SW is now even rarer, because it has reduced power, shorted sked and changed one of its fqs. R NYAB now Sun 0600-0900 on 7040 as before; Wed/Fri 1100-1300 (ex-1400) on new 3395. Power now reported to be 100 watts (Abdullah, Bangladesh, NL)

BOLIVIA R Santa Rosa (del Yacuma), "LV del oriente boliviano" hrd on 4461 at 0200. Two new SW stns soon: Rdf Colosal, Sucre, now FM only, to add MW & SW. Radio Maria Auxiliadora (Catholic), at Colegio en Montero, 50 km from Santa Cruz de la Sierra, now on MW, to add SW 4975 with 1 kW; installation has been delayed. New DX pgm on R Norte, 4938, "Sonido DX," Mon 0100, repeated Thu 1110. Some other active stns recently monitored: R Viloco, 3340, 0200; Rdf Cristal, 5005, 1100; R Condor, 6060, 1100; R Santa Cruz, 6140, 1100 (Emilio Pedro Povrzenic, Argentina, R Nederland Radio-Enlace 13/10)

BRAZIL During CANAV-DX, 4/11 while most were chasing Angolans, I had Braz PT on 3375 at the late hour of 0522; ID sounded like Radio Itaporá, de Macapá; was putting phone calls on the air, and still going at 0605; not listed in '84 WRTVH, tho name sounds familiar and may've been reported since as new stn (gh)

CANADA Govt plans another massive budget cut for CBC in 1985; probably mainly affecting TV, but appendage RCI also in possible trouble--might be separated from CBC or have to go off the air completely. Too early to tell (Various press reports via Doug Copeland, et al., Oct. REVIEW OF INTERNATIONAL BROADCASTING)

CAPE VERDE A Voz de São Vicente booming in during CANAVIX 3/11 2359 on apx 3930--s/off msg, NA, 3 chimes, carrier stayed on, and then more mx after 0000! Maybe post-midnight equipment test; didn't stay tuned to determine how much longer on (gh) In recent QSL letter for 7155, Em. Official of the CV Is (EORCV) indicates it has new addr differing from WRTVH: P O Box 118, Práia, San Tiago Island (Peter Bunn, RA JP DX Time 21/10) Em Of continues QSLing 7155; further research on the mystery of 7155 has led us to this tentative conclusion: fq of Em Of was listed as 6025 til WRTH 83 but was changed to 7155 in WRTH 84 on basis of a collaborator's report. Em Of did reply officially, but left the fq as 6025. However, because many stns do not bother to update such info properly, we trusted the collaborator's report. What seems to be the case is that Em Of has its lower power SW xmtr still on 6025, altho rarely if ever reported, and that 7155 is the daytime fq of the more widely reported A Voz de São Vicente. This is 10 kW, which'd explain the fairly hi number of loggings of this --no doubt it carries relays of Em Of, which is what various DXers have hrd. QSLing of this fq is quite likely - no doubt the stn is unaware of the significance of xmtr site details. We've recently got ITU publication listing all known usage within the offl HF bands between 1960 and 1981. This seems to confirm our conclusion, but we are open to other suggestions! (NL)

CHAD On new fq 3225, and 7120, 4904.5 (SCDX delayed via R Earth 24/10) Confirmation?

CHINA R Beijing bcs in backwards (reversed-tape) Russian: 0300-0355 on 17533 12450 11660 9335 8260 from one site; 17450 15140 11685 11660 11515 11430 from another; and at 0900-0955 on 9335 8260. Numerous other bcs in forward RS (WBI 8/11)

Fujian PBS Taiwan svc (Fu-jian ren-min guang-bo dian-tai dui Tai-wan guang-bo): [SW portion only here]. 0000-0030 Std CH & 0130-0200 Amoy 5040 4975. 1400-1430 SC, 1500-1530 AM, 1600-1630 AM, 1630-1700 SC, 2100-2130 SC all on 4975 2340; as part of Fuzhou DS pgm (WBI 8/11) more, LMIMI

COLOMBIA Despite worsening HF condx, I like to keep tuning above 23 MHz for harmonics, and was rewarded 9/11 1248 w/LAM on 24471; after 1300 it was barely // able to 6118 & surely LV del Llano, previously known for harmonicization; this 4th harmonic was probably sporadic E rather than F-layer skip (gh)

CUBA R Stantsiya Atlantika, 1344 8/11 on 5064, vvy strong in Russian, distorted sig. Not //4765; strength suggests another Cuban relay, but not sure (Mitch Sams, Wichita KS, Ozark Mountain DX Club DX Log) Not hrd on later daytime check here (gh, FL FL) RHC in EG to NAm 0100-0455 on 6140, // 11725 at least during first part; 11725 poor, gen'ly fades arnd 0300; 6140 is co-channel HCJB from 0200 (John Norfolk, OKCOK)

DOMINICAN REPUBLIC R Earth's new addr in Santo Domingo: P O Box 92-2; 17/11 and that'd have a new bc on R Clarin Sun 18/11 at 1700-2400 UTC, 11700; perhaps CID didn't need that time period. Reception great until usual quick fade arnd 2235; got calls from all over NAM and resolved to do it again following Sunday afternoon (gh)

ECUADOR New stn LV del Upano, Macas, has a DX listeners pgm every GMT Sun 0015-0035 on 5040, "Contacto Internacional"; 27/10 answering letters from Olle Alm and Gerry Dexter; mostly in SP, a little EG (Tom Williamson, Guelph, DX Ontario)

HCJB's complete SP sked for D84: SA m 1030-1200 11910, 1030-1530 9765, 1030-1430 (Sat/Sun 1500) 15390, 1530-2145 17890, 2245-0500 11960, 0130-0230 15250. NAM 1200-1530 11910, 1030-1430 (Sat/Sun 1500) 15390, 1530-2145 15160, 2245-0500 11960, 0200-0500 6050, 0130-0230 15250. Regional: 1030-0200 6050, 0200-0500 6090 & 3220. Local: 1030-0500 on 690 kHz MW. Eu 2200-2230 21480[sic] 17790, 0500-0530 11835 9655(stn)

EL SALVADOR R El Salvador's 10 kW SW xmtr has resumed relays of DS in SP, hrd on 5992 from apx 1000 to 1300 and 1900-2100. Adventist World Radio's DX nx pgm on 4/11 said RES hrd on 9587.5 at 0013-0300 (WBI 8/11)

GABON, last minute info

EQUATORIAL GUINEA Bata on 15106.7 hrd w/various US EG relig pgms 2000-2145, then hllife mx & NA to 2200\*; G sig 17/10 until 2122 DW QRM (Ernie Behr, Ont) Never audible when I check--bad luck, prop variations, or not always active? (gh) More, IMI

GAMBIA R Syd, 7424 & 7485 has replied directly, contradicting all the sources who maintained that no reports would be confirmed by the station directly; in 30 days; QTH: Box 279 & 280, Banjul; v/s Miss Costance Wadner Enhorning; 1 IRC sent (Claudio Dondi, Italy, Play-DX 29/10) Cf last month; was active one day only for half hour

GREECE V of Greece 10/11 0135 w/nx in EG on 6205 (Chuck Oliver, Spring TX) VOG changed fq from 6205 to 6225, 0435-0450 11/11 (David Swaringen, NC) But Still on 6205 for earlier xmsn to NAM, at 0025 check 18/11 (gh) FRANCE, GERMANY E, GHANA: IMI2

GUATEMALA 6090 at 0245 12/11, and both in SP & EG but terrible het ruined most of it; andc FM stn and "Church of the 7th Day Adventists in Cam", P O box, relig mx. 0300 TGMUB ID in EG, relig pgm in EG (Chuck Oliver, Spring TX) Yes, het; measured here 10/11 1434 on 6090.6 w/SP relig pgm, many Adventista ments; at this hour lots of other CAM sigs still audible on 49m here (gh) more, IMI & HONDURAS IMI

GUINEA BISSAU R Bissau [do they really ID that way? -gh], 5475.1, sent QSL card in one month for no IRGs; gave fq as 5041; QTH B P 191 (H Gustafsson, Sweden, Play-DX, 29/10) B P? That's French; in PT should be CP = Caixa Postal (gh) /more INDIA IMI

INDIA AIR on 7260, hrd 17/10 \*1228 w/IS, CH or T'betan lang, Buddhist chants to 1315\*; noted since 5/10 w/weird chants & mx, but often in ham QRM, hard to ID lang; my unID of last month; possibly // 9705, but not sure. Strangest chants I ever hrd; try to listen (Ernie Behr, Kenora Ont) Listed in WRTH 84 as Tibetan svc, 250 kW

INDONESIA The four new xmtrs at Cimanggis were officially put into opn for RRI Jakarta Programa Nasional on 21/5/84 (not 16/4 as earlier reported): One 250 kW Thomson CSF on 11700 for E Indonesia = Irian Jaya; three 100 kW Harris Gates, on 6045 beamed to Sumatera, 7270 to Kalimantan, 11770 to Sulawesi & Maluku (E H Pranato, ibid, ADXN)

RRI Dili again using 90m channel 3308, well hrd in Au at 1400 w/ID & wavelength; regional nx relay from RRI Ujung Pandang at 1107; different pgm on other Dili fq, 3987 (Craig Seager, RA Japanese DX Time 4/11) much more, IMI

IRAN VOIRI using new ch for AR pgm; Tehran now hrd on 9830 12005 13745 15580 at 0700 --reception marred by jamming at most times, but sigs still well hrd, presumably hi-powered (Craig Seager, ibid. in its original sense)

ISRAEL, IMIMI

ITALY RAI is trying to have 2500 of the 4000 FM fqs in Italy allocated to it, leaving only 1500 for private stns. Since most domestic radios have one SW band, more and more private stns may move to SW if squeezed out of FM (Fabio Borborini, ibid., RIB)

JAPAN R Japan complete D84 sked in EG: 0000-0100 NAM 9645 11710. 0145-0245 N&C&S Am & Haw 21640 21610 17825 15195. 0630-0700 Eu 15235. 0845-0945 ANZ 15235 11875. 1800-1830 SAs/Af 9645 11840. 1930-2000 Eu 7105 6080. 2015-2045 ME/NAf 7105 6080. 1215-1245 SEAs 15235 11875. General svc: 0100-0130 & 0300-0330 17810 As, 17755 Am. 0500-0600 17810 As, 15300 Am. 0700-0800 17810 As, 9505 Am, 15235 Eu, 21575=Gabon ME/Eu. 0900-0930 15195 As, 9505 Am, 15235 Eu. 1100-1130 15195 As. 9670 As, 9505 Am. 1300-1400 11815 As, 11840 SAs, 9505 Am. 1500-1600 11815 As, 9505 Am, 7235 Eu, 21695=Gabon ME/Eu. 1700-1730 11815 As, 9505 Am, 7235 Eu. 1900-1930 11815 As, 7235 Eu. 2100-2130 11815 As, 7235 Eu. 2300-2330 15210 As, 15235 SEAs, 17755 Am, 7105 Eu (via Kraig W Krist, VA)

JORDAN, IMIMI

KASHMIR AZAD AKR on 4790.5, ex-4980 due to KKK (Krazy Komeini Kiloton), 1610-1803\* 10/10 & 21/10, G (Fabrizio Magrone & W Mola, Italy, Play-DX)

KENYA VOK reported that Minister for Info & BCing ancd in parliament 24/10 that VOK 'd soon start an ES. Told House that world outside had many things to learn from Kenya and it'd only be possible when VOK started an ES. Min had said this, VOK reported, when he moved a vote to allow the Ministry to withdraw nearly 80 megashilling from consolidated fund so that Min could meet its recurrent and development expenditure until next June. Min said was bldg xmtr at Koma Rock in Machakos district which, when completed, 'd not only improve radio reception in eastern parts of country, but 'd also make the external service possible (WBI 1/11)

KOREA NORTH Pyongyang on 13725 at 0928 & 2145 10/10, most likely 5 x 2745 Shinuju (Craig Seager, Nov ADXN) Doubt it's 'most' likely anymore w/stns moving into the 22mb; WRTH spells it Shinuiju (gh) HS in KR arnd 0600-1100, 2200-2400+ in apparent reduced carrier SSB mode, //2475 11680; unsure if harmonic or fund (Padula, ADXN)

LEBANON 6215, King of Hope, EG relig pgm, EZL mx, ID "Voice of Hope" 24/10 at 2015 (Denman Peniston, Chester NJ, Ozark Mtn DX Club) King of Hope now w/some strange lang combinations: \*0300 in AR, 0600 EG, 1000 AR, 1500 EG, 1700 RS, 1830 GM, 1900-2000 in FR/SD/RM/VT, 2000-2300 EG (Andy Sennitt, PA, RNMN 16/11)

LIBYA Axually on registered fq 17895 ex-17930, \*1100 //15415 15235 9890; but 17940 still used for Sudan pgm at 1400 (Noël Green, UKOGBANI, RCI SWL Digest 4/11)

MADAGASCAR RT Madagasakara, 5011, 6/11 \*0257-0340f, FR, repetitive IS, hymnk, choral anthem 0259, FR ID "Radio-Télévision, Malagas...diffusion du...GMT". Af steel guitars, W in FR. Hadn't logged this in a while (Mitch Sams, KS, OHDC DX Log)

MALTA IBRA Radio on new sked in Oct, via R Méditerran on 9720 1900-2000 PL, 9545 20 00-2115 in HG, GM, EG, as monitored (Bob Padula, RA JP DX Time 28/10)

NETHERLANDS R Nederland made first on-air tests of new Flevoland xmtrs 26/10, 1630-1720 to Carib, well hrd here on 15560 and 17605 and 17655 fading out. Media Network ancd an extensive 6-day series of tests for 12-16 Nov, some w/a 25-min test anmt cycle in sevral langs, some // regular pgming. Since it was stated that the test sked would not later be enacted permanently, there's little point in going thru it now; however, the ancd sked was incomplete, as no 13 MHz fq was mentd, but I hrd Flevo tests on 13670 before and after 1630; Radio Enlace 17/11 gave a more complete version for the final day, mentioning that fq, and also 26095, 25950. The object of these was not so much to be picked up by listeners, as to test the flexibility of the computer-controlled frequency and antenna switching system. Once in regular use in Jan (?), considerable restruxuring of RN lang sked is likely, e.g. during NAM eves, Flevo carrying different lang sked than Bonaire. Look for EG to be available at an earlier hour, such as 0130. Tho there was no guarantee ancd xmsns would be on the air continuously, whenever I checked the Flevo eve test fqs to NAM, 6020 and 9895, nothing was to be hrd; propagation was rather poor that week (gh) more, IMIMI

NEW CALEDONIA Nouméa's 11710 outlet with 4 kW has been off the air due to tech difficulties since June 84 for most times; returned for brief period in Sept, then disappeared again (Robert Jones, ADXN) But still relatively easy on 7170

NEW ZEALAND RNZ will change name of SW svc to RNZ International. Major pgm changes will be taking place and "bcing time'll be cut by 50% to allow outdated xmtr to target pgms into key target areas." News, sports, mx pgms will be bc instead of the fulltime airing of the domestic Natl Pgm. Main targets will be Au & Pac Is, PNG, Japan, SEAs, and "the western states of NAM, from BC to southern CA". Major revamping of RNZ 'll take place over next 5 yrs. Financing 'll come in part from a proposed licence fee on radio sets. Previously, only TV sets were subject to such a fee (David Wilkes (sp?), Wellington on R Australia Talkback, 10/11, 1610 via Frank F Orcutt, Buffalo NY) Usual NZ reporter is David Ricquish(gh) more, IMIMI

NIGERIA R Nigeria-Lagos reported 23/10 that all 'mushroom' (BBCMS ed note: sub-standard, state-operated) radio stns established in the 19 states of the country were to be closed down. The SW stns in Lagos, Ibadan, Kaduna, Enugu, Abuja 'd be re-equipped to offer better services to the nation and to save costs. This decision by the Fedl Military Govt 'd been ancd in Lagos by the Chief of Staff - Supreme HQ, speaking at inauguration of the committee on the rationalisation of radio and TV svcs, headed by Managing Dir of Cadbury (Nigeria) Ltd, a former Dir-Gen of FRCN. Chief of Staff noted that at present there were 19 radio stns, 4 FRCN zonal stns and 19 FRCN outlets in the States, incl Abuja. Altogether, the country had a staggering figure of 48 domestic radio svcs providing local bcs daily. 24/10, R Nigeria-Lagos reported a clarification on mushroom stn closedown--those affected were the radio stns established by FRCN in the states and not the state govt-owned stns, which could continue their pgms but'd have to relay R Nigeria for net nx and pgms (WBI 1/11)

So apparently the stns to be closed down are all MW, except, by elimination upon consulting the WRTH, Overri 4755. "Staggering" to have 48 domestic local radio services for Africa's largest country? Much smaller countries in the western hemisphere have more than that, and the US without thrice the population has about 200 times as many d.l.r.s. (gh)

NORWAY RNI fq sked gives info about new xmtr site construction. Kvitsoey, so far costing 200 megakroner, intended for SW xmsns to Ehem, western limit being 225° - Brazilian coast. Sveio'd cover C&NA, but not expected ready til 1986 or 87. Originally, three 500 kW xmtrs planned for Sveio, but reduced to one for economic reasons. During power disturbances, maintenance work etc., Fredrikstad site, which could xmit in all dirextions, 'd take over. Also says domestic Pl would experiment with nighttime radio until yearend, and'd include overseas pgm so domestics could hear it too, 0100-0200 nightly exc Sunday, incl Kvitsoey 1314 kHz (WBI 18/10)

PAPUA NEW GUINEA Planned move of 120 mb Provincial stns to 90 mb is first step towards eventual replacement of 2 kW xmtrs w/10 kW units. Lower fq limit for new xmtrs is 3.2 MHz. New antennas'll also be required for stns moving from 120 mb. PNG govt'll announce annual budget in Nov; NBC is dependent on large incr in funds to carry out its planned development pgm (Robert Jones, ADXN)

PERU R Nuevo Continente, 5190.8 or 5190.7, 13/11 2253-0001+, comments and mx, ID, poor (Chuck Bolland, Lakeworth FL) Juan Carlos Codina says this one has been inactive for a year, sporadically coming back briefly (gh) Estación 2000, 9988 at 0335 31/10, sounded like square dance calling. unID SP on 8922, R Continente, at 0350 31/10; "Coke is it" ad, 0352 ID, 0355 s/off w/NA; what country? (Chuck Oliver, TX) Here's your answer; ex-8900v (gh) R Continental, Arequipa, announces new fq 9685 // 6055, 740, R Mundo, Cuzco will soon have 4 SW xmtrs on 60 and 90 m (Emilio Pedro Povrzenic, Argentina, RN Radio-Enlace 13/10)

PHILIPPINES FEBC D84 in EG: 6030 2300-2315 50 kW 140/320° to Phil. 11815 0100-0500 50 kW 280° India/SEAs. 11850 1300-1600 50 kW 280° India/SEAs. 11890 0500-1000 50 kW 150/330° Au/NZ. 15445 0000-0100 50 kW 280° India/SEAs. 15445 2300-2400 50 kW 240° Malaysia. 21515 2300-0500 2 kW 140° PNG. 21530 0500-1000 2 kW 285° India/SEAs. (via Foxx, Norfolk VA) Cf Oct FRENEX p 27; lots of changes also to other-lang svcs. (gh) Good Morning India svc, 0130-0230 incl DX pgm Wed 0220, on 15450 (Alok Das Gupta, ADXN) ex-11815 for entire 4 hours? (gh)

SALPAN KFBS now using two 100 kW xmtrs, and a 3rd is due on shortly (Arthur Cushen, NZ, RNMN 1/11) Planned D84 sked of KFBS: KFBS-1, to be operational at start of D84 : 21-23 Chinese 9515, 09-11 11720 RS, 11-13 CH 11880, 13-16 CH 9515. KFBS-2: 21-24 CH 9650, 09-11 CH 11710, 11-14 CH 9610, 14-15 RS 11940, 15-16 RS 11820, 16-1615 UD 9580. KFBS-3: 22-23 IN 15225, 23-24 VT 15225, 10-13 various langs 15115, 13-15 VT 15350, 15-1545 Malayalam 11705 (Alok Das Gupta, Nov ADXN)

SENÉGAL [Cf Nov FRENEX pp 28 & 45] Recent monitoring shows 2nd xmtr on 60m, IDing as Office de Radiodiffusion-Télévision du Sénégal, on 4951 from apx 2000 w/separate pgms from net-one on 4890; 2200 the two linked for FR nx, then separated, 4951 in FR and 4890 in local langs. Fq smt before 2400\* on 4951 mentd 11895 4890 1305 765 (WBI 18/10)

SEYCHELLES FEBA D84: 6030 0026-0113. 7130 1627-1730. 7160 2157-2300(Sun 2315). 7165 1827-1845(Sat/Sun 1900). 7275 0114-0216. 9510 1612-1700 & 1731-1833. 9575 0257-0330. 9600 1700-1716(Wed-Sun 1731). 9610 0312-0400. 9670 0157-0300. 11750 1700-1716(Wed-Sun 1731) & 1731-1833. 11755 0342-0430(Sun 0445, Fri 0500). 11760 1612-1700. 11790 1608-1626. 11810 0312-0400, 0400-0500=Sat/Sun, 0457(Sat/Sun 0500)-0530. 11855 0217-0305. 11865 1202-1220 Sat, 1227-1415. 11895 1415-1608. 15200 0400-0500=Sat/Sun, 0457(Sat/Sun 0500)-0530. 15320 0712-0830 Sun, 1202-1220 Sat. 15325 1227-1608. 15405 1057-1145(Sun/Thu/Fri 1200). 15430 0912-1000(Wed 0945). 17780 0712-0830 Sun. 17875 1057-1145(Sun/Thu/Fri 1200). Power 75 kW in most cases but with these exceptions: 25 kW on 11750, 11760, 11810. 100 kW on 7160, 11790, and at 1202, 11865 (FEBA)

SRI LANKA SLBC drifting again, 9719 12/11 1605\* in EG after Church of God pgm, next day's sked (Mitch Sams, KS) [Cf Nov FRENEX-23; following sked differs] DW HF Dept issued D84 sked for Trincomalee relay: 17845 Af 0545-08, Afgh 08-09. 17815 SEAs 1215-14. 17800 SAs 00-0315. 15215 SEAs/AuAs 0915-1030. 15105 SEAs 01-03, SEAs/AuAs 0545-10. 11765 Af 18-20. 11705 ME 1845-2045. 9545 FE 0945-14. 9510 FE 1115-1230. 7265 China 1230-1430. 7200 SAs 1415-17. 7110 China 22-24. 6185 SEAs/AuAs 2045-22. 6160 SAs 1345-18. 6060 FE 2000-2145 SAs 2145-0100. However, DW printed pgm sked for Nov doesn't include these channels (WBI 1/11)

SUDAN Japanese rx agcy Kyodo reported 7/10 that Japan'd be providing 1.95 gigayen to help finance a project for the expansion of the being net in Sudan (WBI 25/10)

SURINAME The R Surinam Intl svc in Dutch & Sranan Tongo, bc via Brasilia, now hrd Mon/Wed/Fri 1730-1825 apx on 17755; Sun bc replaced by the one on Mon (WBI 25/10) On the Fri after Gandhi assassination, happened to hear untranslated EG segment at about 1745, Indian ambassador to Surinam answering question; after all, everybody in Holland speaks English too (gh)

more SUDAN, IMIMI SWEDEN, IMI

SYRIA Damascus on new 7425, 2300-2329\* starting 21/10, ex-7365 (Artie Bigley, TX)

TAIWAN WYFR relay via VOFC on 9845 in Chinese 2100-2300 19/10 (Bob Padula, ADXN) On 15055 in EG 2100-2215+, not //9852 & 9535 22/10 (Padula, ADXN) Also at 1335 in EG on 15055 ex-15525, 16/10 and could hear a BCC pgm in background (Robert Chester, ADXN) But see USA below (gh) Voice of Asia, Kaohsiung, in EG: 0010-0110 & 0600-0700 SEAs 7285, 1030-1040 SEAs 5980 612, 1100-1200 SEAs 5980 612, 1500-1530 SEAs 5980 612 (WBI 25/10)

UGANDA R Uganda, 5026, 0310-0414 13/10--EG/vern, local Af mx, ID 0312, 0400 EG rx 0408 ID; fq slowly drifting downward - 5026 at 0310 but 5025.5 until adjusted back to 5026 at 0411 (Brian Alexander, Mechanicsburg PA, OMD)

U S R R Moscow monitored in Oct on these 13 MHz band fqs: 13600, 13620, 13625, 13635, 13645, 13650, 13660, 13665, 13680 (numerous ADXN Nov reporters) Also moving into another fq range: after 0800 on 17925, 17970 (Padula & Seager, ADXN) In addn, to 22mb usage, R Moscow ES also using 11 & 75m for first time. Pgms in RS for Soviet seamen and compatriots abroad obs 0800-1330 on 25620, whilst Polish on 4060, and as 74m band, at 1400-2200 (WBI 18/10) 4060 also noted after 2200 w/RMWS at GANAVDX; site? (gh) more, IMIMI

U K O G B A N I First xmtr in the 23 megapound rebuilding of Rampisham-one of the BBC's hi power UK xmtr stns, is in operation and serving Russia and EEU. Uses double the power of the old xmtrs - 500 kW stead 250 - and aerial is a prototype of a new design developed by Transmitter Capital Projects Dept. The scheme at Rampisham, in Dorset, is now almost halfway thru its 4 yr pgm. Next step forward'll be two more 500 kW and six new aerials planned to come into opn later this yr. When Rampisham re-engineering is complete, there'll be 10 xmtrs serving any of the 34 aerials that'll be on site. Computerised control system'll handle switching. A number of advances'll provide better sig overseas w/less interference, and give BBC more flexibility in use of xmtr resources. All the new xmtrs'll be capable of automatic tuning over the whole of the hi fq (SW) spectrum, and each aerial can op on 4 hf bands, instead of two as at present. For first time, all feeders carrying signals between switching stn and aerials 'll be screened, using a total of 12 miles of aluminium trunking. The trunking is to protect against wx, dust, birds and smoke from stubble burning, which has in the past caused operational problems. Noel Sudbury, heading the project, said the biggest difficulty so far has been carrying out the work while maintaining a svc. Some xmtrns Rampisham normally carries have been transferred to Daventry and Skelton. The old 250 kW xmtrs have been reinstalled at Skelton as they have been removed; and xmtr bldg on the site has been completely gutted. "It's an expensive project partly because of the sheer cost of raw materials involved," said Sudbury. "For example, each aerial contains between three and four tons of copper." "It is something of a race against time to come in on target. Because of the need for speed only nine more of the new aerials are of the specially developed TCPD design - 12 others are being provided by the American company TGI. Then we'll decide who will produce the last 12 aerials depending on how the first lot have performed." (DX Kuuntelija, Sept, via Asian DX Review, Oct)

BBC Antigua noted trying 9515 until 0700, then back to 9510. Sackville relay on 9590 has been missing; due to El Salvador 9587? (Jim Conrad, IA)

more USA, IMIMI  
U S A An oddity, at 1745 11/11 on 15065, hrd both BBC and WYFR announce; spurs? Also 6/11 at 2055 past 2100 relig pgm in EG, later IDed by paralleling as WYFR, on 15065 (Chuck Oliver, Spring TX) See Taiwan above, reported on 15055 at same time; but if you were able to // to US site, 15065 morelikely spur than deliberate (gh) WYFR starting in Nov stays on all night; rather comes back on at 0830 after 0810\*. At 0830 in SP on 6175 9605; 0900 SP on 6175 9605 6015; 0930 adds 9550, co-channel Cuba; 1000 on 6175 and 9605 in FR; 9550 and 6105 in SP. Eu svc at 0700-0800 on 6160 7355 9680 9852. Canadian svc moved from 11830 to 11805 (Jim Conrad, IA) From the NL, I excerpt the WYFR D84 sked after 0800: WCan 1200-1300 5995, 1300-1600 5985 [actually switching around 1245, and the :45 switching probably applies to other fq as well]. SP SAm/Carib 0800-1100 6105 9550. SP Mex/CAM 1100-1200 6175 9605, 1200-1300 9605 11720, 1300-1400 15355 17785. NMex SP 1200-1300 11855, 1300-1500 17730.

Spanish to Brazil [sic] 0900-1000 6175 9605. FR to SAM/Carib 1000-1100 6175 9605 [ha --6175 should be familiar fq to French Guiana listeners], 1200-1300 Canada 6095. PT to Bz1 0800-0900 6175 9605 (NL) WMLK testing on air last week but MW xmtr conversion is not complete; low power & sporadic w/in these times: 1700-1900 on 15110, 0400-0600 on 15150; running about 25 kW, not yet on main antenna; (RNNN 16/11) A report on SCDX from W Germany, 13/11 of WMLK on 15106 2030-2150 is surely EQ Guinea instead (g)

URUGUAY R Monte Carlo using 9595 at 1600-1630, 2130 (SCDX 13/11, missed reporter)

VANUATU From 25/9/84 to 23/3/85, SW sked of R Vanuatu on 3945 & 7260 is 1800-1015 (Sunc to 0900). No longer a daily 3-hr break; previously there was no Sun morning svc either (Robert Jones, ADXN)

VENEZUELA Previously unhrd Ondas Panamericanas noted 6/11 2311-2345 on 3215.1, S<sup>P</sup> mx, ments, SAM pop, USA pop, GMT-5 TC, poor; also 7/11 1020-1030 SAM mx, ID, TC, fair. Seemed to be on all night; but 8/11 0035 not hrd (Chuck Bolland, FL) I don't understand why they would give a GMT -5 TC (gh) R Nacional will have two new 50 kW [SW?] xmtrs by Dec (Christian Zettl, Austria, SCDX 13/11) more, LMI

VIETNAM VOV reported 7/10 that two SW radio stns had been set up in Xian Loc district and Bien Hoa City. (WBI 18/10) Vietnam R & TV Commission, Hanoi, Voice of Vietnam DS on 10060 7418 6450 5920, MW & FM: 2200-0200, 0400-0630, 0900-1630 but Sundays 2200-0630 & 0800-1630. Final hour from 1530 is pgm for overseas compatriots. Regional stns in Viet, Montagnard and/or tribal langs, on variable times & fqs: Bac Thai 6815 0330-0530 & 1130-1330. Cao Bang 6520 0400-0600 & 1200-1430. Gia Lai Cong[sic] Tum 4702 2300-2330 & 0300-0430 & 1030-1400. Hanoi City 7990 6850 2330-2400 & 1030-1330. Hoang Lien Song 6678 5602 0000-0030 & 0400-0500 & 1000-1030 & 1145-1300. Lia[sic] Chau 6592 0400-0600 & 1145-1300. Lang Son 6510 0300-0430 & 1130-1330. Nghia Binh 5080 1130-1300. Phu Khanh 5140 1030-1230. Son La 6330 0300-0500 & 1200-1400. Than Hoa 4885 2330-2400 & 1030-1100 (WBI 25/10)

Hoang Lien Son on 6695 ex-6680, 25/9, and in Oct as high as 6699 competing with V of Malayan Democracy. Hoang Lien Son on 5597 & 6698 at \*1000-1030 VT, \*1145-1200 Thai, 1200-1215 Hmong, 1215-1230 Viet, 1230-1245 Tay (tent), 1245-1300\* unID lang. Cao Bang on 6531 17/10 ex-6490, but later back to longtime 6519 where it had been until mid-Aug; so was on 6490 nearly two months; \*1200-1400\*. Bac Thai moved from 6830v to 6621 in early Oct, probably strongest Vietnamese local at the moment. Not so many move for Bac Thai and Cao Bang this year, but both station begun to hanging around more frequently? \*1125-1330\*. Reception of Lang Son now sporadic; still on 6510, but with ute sigs, often unconfirmable; quite a big diff when comparing several months ago--at that moment it was one of the most regular and strong ones. Ha Tuyen, always in not-so-easy category, re-appeared on 4813 11/10 arnd 1315-1340, w/ pgm changing to Viet from 1330. Became unusable from 1340 that day. Checks succeeding days all failed. Gia Lai-Kon Tum still on 4700 arnd 1100 but weak. Son La on 4701 & 6333. Binh Tri Thien, another unreliable one, confirmed on 4672 to 1357\* in VT. Nghia Binh, 5090 in May & June, untraced (Isao Ugusa, Japan, DX Front Line 23/10) Lai Chau on 6585 at 1200 local VT nx. Bac Thai strong on new 6620 ex-6830; best 1200-1300; Cao Bang on new 6498 ex-6515, seems steadily downmoving, ex-6525, fair w/ute QRM 1200-1330 (Peter Bunn, RA JP DX Time 21/10) more, LMI

YEMEN SOUTHEAST DYBS official sked: 0230-0700 & 1100-2200 (Fri & holidays 0230-2200) on 5970 6005 11770 (NL)

## CLANDESTINE CRANNY

Radio SPLA Since 18/10, a stn in EG & AR ID-ing as "Radio SPLA, the voice of the Sudanese revolutionary armed struggle" hrd making daily test bcs 1300-1400 on 9610; anmts in AR expand the abbr to Sudan People's Liberation Army. Listeners invited to send in reception reports to offices or reps of the Sudan People's Lib'n Movement (SPLM). Test bcs also carried msgs of congrats on opening of stn from, i.s., John Garang de Mabior, Chairman of the SPLM and Commander-in-chief of the SPLA (WBI 25/10) Could hear her coming on Perth 9610 at 1300, but that's all (gh) Continues daily tests 1300-1330 EG, 1330-1400 AR on 9610; mx and songs interspersed w/stn anmts and msgs of congrats on opening. 30/10, ancd that tests'd end 1/11 and regular pgms begin next day. Xmtr believed to be in Ethiopia; VORE's 1300-1400 Afar svc now obs on one ES fq, 7165, instead of two (WBI 1/11) & the people starve...

V of the Homeland (AR: Sawt al-Watan), operated by the al-Maqasid benevolent charity organisation, supporting Sunni Muslims in Lebanon, on 1134 kHz entirely in AR 0400-2230; one hour earlier during summer time. R Kuwait reported this stn started expl xmsns 27/3/84, but not traced until 1/8 (WBI 1/11)

V of the United Muslim Fighters of Afghanistan Stn hrdin Dari 7/10 to 1627\* on 15555 IDing as The Voice of Unity (Dari: Sada-ye Vahdat). 1630, The Voice of the Liberation

of Iran (Persian: Seda-ye Jebhe-ye Nejat-e Iran) signed on as usual on 15555. However, 12/10 a bc on 15050 & 11630 at 1530-1630 IDed variously as The Unity Radio of the United Mojahedin of Afghanistan and The Voice of Unity. And end of xmsn gave this addr: P O Box 284, Vienna 1061, Austria (WBI 18/10) Why headed VOTUMFOA?  
R Iran Trollers: see AFGHANISTAN [answer to above: IMLMI]

V of People of Malaysia still hrd on 7072, 1130-1330, 1430+, often badly QRMed by local hams. Sounds not so different from VOMD--both tone and music, but probably difference in content. Let's receive this stn when it is hrd! (Isao Ugusa, DXFL 23/10)

V of Malayan Democracy, 6699 spoiled by Hoang Lien Son which moved to 6698v since late Sept. VOMD stronger early Oct but later situation reversed in late Oct, and // 8999 can't be confirmed as bf 22/10; 6699 sig was strongest ever monitored; that was early to mid Oct; sked \*1215-1330\* (Isao Ugusa, Kobe, Japan, DX Front Line 23/10)

Voice of CID / R Camilo Cienfuegos. Further survey of this anti-Cuban-govt stn reveals it no longer operates arnd the clock and that 10040 no longer // other SW channels: 0000-0505 7400 or 7352.5. 0955-0455 10040. 1015-1200 7400 or 7352.5. 1200-2400 11680 (WBI 25/10) A further change noted to this stn's fq usage: now obs on two channels in // : 0000-0300 7352.5 6300. 0300-1200 7400 6300. 1200-1245 11680 & 6300. 1300-2345 11680 10040. Thus, RCC is on air 23 1/2 h a day; two breaks of apx 15 mins enable a xmtr to change fq between 10040 & 6300 (WBI 1/11) more, IMI

R Venceremos CAM nx agcy ACAN reported 23/10 that the Salvadoran govt had seized eqp belonging to a clandestine guerrilla radio stn in eastern dept of Morazan after engaging in fierce fighting w/rebels. Mily source in the 3rd Infantry Brigade based in San Miguel had said eqp belonging to RV had been seized previous night in township of Joateca in Morazan Dept near Hond burder. However, ACAN sources said the report could not yet be considered official cause offl confirmation was still awaited from Morazan mily commanders. RV, offl voice of the FMLIN, had not transmitted its sked pgms, ACAN said, on eve of 22/10 or morn of 23/10 (WBI 25/10) RV, which claims to op from Morazan dept of El Salvador, not obs at all on 23/10. But 24/10 0000, apper ed on 6557 apx saying "This is Radio Venceremos, which COPREFA (ed note: Armed Forces Press Committee) and the imperialist news media have reported as destroyed. This is RV, which the senior military authorities of the dictatorship said early this morning they had destroyed for good. RV is like our people - indestructible. The gringos will have to destroy our entire homeland if they wish to destroy our station". RV subsequently hrd at sked times of 0000, 0230, 1200, 1830. During 1200 xmsn, said "What is more, we announce that, in our 1800 & 2030 (local time) xmsns, RV will bc on the 80m band, in addn to the 40m fq." Monitoring 26/10 found it at 0000 & 0230 on fq varying 3650-3665, // 6555 (WBI 1/11) At 0050 on 3603 (Mitch Sams, undated logging in OMDX DX Log 13/11)

Radio Farabundo Martí, claiming to operate from El Sal dept of Chalatenango, still hrd on 6590 at 2300, 0100, 1300, 1830 apx; 24/10 hrd to 1337\* on 9906 // 6590 (WBI)

Radio Monimbo, a stn calling itself this, hrd on 6230 0000-0100 & 0200-0300, in SP, describing self as voice of freedom of the Nicaraguans; hostile to Nic govt. First monitored in Oct, but believed to have started some months earlier (WBI 18/10) As reported here before, discovered by several DX listeners 16/9 (gh) Also daily at 1300-1400. Pgmng consists of three 5- to 8- min commentaries interspersed w/lengthy periods of pop mx. Commentaries consist of bland, generalised attacks on the Sandinist govt of Nicaragua (WBI 1/11)

R Freedom Obs of the R Zambia ES on 9505 24/10 showed it also bcs this pgm on behalf of the African Natl Congress, ANC. Anmt said it was daily at 1700 (WBI 1/11)

R Truth 12/10, ancd postal addr for listeners to send items of nx of interest to the Zimbabwean public or their comments and criticisms of the contents and presentation of the pgms, both in EG and vern: Mr. J. Brown, P O Box 4, Stockbridge, Hants. SO20 6LB, England. R Truth said it had always been interested in hearing the news and views of its listeners but that up to now these had been confined to exchanges by word of mouth (WBI 18/10) Moved to 5030, daily 1700-1755 (R Ginbey, RSA, RNMN 16/11)

NORTH AMERICAN PIRATES R Truth, 28/10 1935-1955 on 7434 LSB. Very strong, ancd testing, played mx, talkd about some anti nuclear book, and claimed Ohio QTH (Chris Smolinski, MD)

R Sound Wave hrd 11/11 0341-0346 on 7425 LSB, song by Howard Jones, ancr mentd stn'd be signing off since pgm not organized; 73s & tnx for listening (David Swaringen, NC)

R Clandestine 11/11 0600-0619\* on 7390, supposedly "humorous" songs bordering on the obscene at times (John Norfolk, Oklahoma City OK)

V of Laryngitis 12/11 0255-0325\* on 7435. Good reception of a bizarre, goofy pgm; assassination of Atilla Huxley; "Junior Piratebusters" with J. Eager Heever, with song "Piratebusters" (spoof of "Ghostbusters"); the death of Atilla Huxley; "Almost Heresy Hour"; John Denver and Spam; "The Atilla Huxley Memorial Show". Requested reception reports be addressed to "Bite Your Face Genghis"--not "Dingus" as I thought at first--at usual Battle Creek box; by far the best pirate bc I've hrd to date (John Norfolk, Oklahoma City OK)

## LAST-MINUTE INFO

EQUATORIAL GUINEA On 15106.4, 2035-2145 in EG, weak, fading to inaudible at times. Strength improves past 2100 to continuously audible signal; doesn't even move needle on R71A S-meter most of the time, but some bursts are up to S4. Hrd several days now, always fading in around 2030 and always getting ruined when DW starts to fire up Carib xmtr on 15105.0 for PT xmsn to Brazil; DW runs 20-30 dB over here, afternoons. Pgm is always EG and always religion. Some of it obscure country-type stuff w/write-in adrs in TX, OK. Never any IDs for stn itself, just those tapes w/odd timing--none yet have ended on the hour, the half or the quarter. Between tapes they play 15-30 sec of rock mx! Weird stuff by foreign artists and sung in foreign langs. Theory: this is R Nacional de Guinea Ecuatorial's foreign svc. They have apparently abandoned the intended Spanish 1800-2130 for more lucrative bcng of these religious tapes. It surely isn't Veritas Asia I'm hearing, as that one is the baby of none other than His Ex. Cardinal Sin, of the Philippines, and a Roman Catholic stn would not be playing Baptist tapes. 12/11 held them until 2145 using USB ECSS, but DW was just too much as their strength increased and the mystery stn's decreased. Splatter was awful. Still no ID hrd. Arnd 2130 strength up to an honest S10 322 rating. Had drifted to 15106.5 by 2130. 14/11, around 2145 carrier audible on 15106.7; DW putting out such splatter I could not distinguish that they were modulated or not with voice. But I'm betting they're audible somewhere, past 2130. Doubt they'd resist the chance to sell airtime to USA fundamentalist groups, even if they had to go beyond the 2130 deadline. Good Lord! If I can get them way up here in the "signal starved northwest" I should imagine everyone else could! (Robert R Palmer, Spokane) R Nac Bata, 15106.5v, noted 2/11 as early as 1730 w/EG relig pgms past 2120 DW s/on; at 2011 had SP ID requesting repts to "Servicio Internacional", new box number which I missed; very irregular, not daily (Ernie Behr, Kenora Ont) Guess what? This stn's former fq, 7998, is very close to one listed in a 1942 reference of utility weather broadcasts from here. I can imagine ancient xmtr being uncovered and fired up for this (David Newkirk, Seattle)

GABON R Japan relay on new 9570, vy strong since 4/11, from 0400 in RS, 0430 SW/IT/GM/FR to 0559\* (Ernie Behr, Ont)

GUATEMALA AWR stn TGMV, 6090.5 from 0100 SP, 0300 EG rel pgm & mx to 0358\*v; strong 7/11 since Cuba moved to 6140 on top of HCJB. Another LAm on 6090 from 0300 in SP, much wkr & did not sound like Belgrano (Ernie Behr, Ont)

HONDURAS LW del Junco now on exactly 6075, from 1150 w/ID & LAm mx to 1245 f/out; much stronger than before, perhaps new xmtr; 3/11 (Ernie Behr, Ont) & later here (gh)

INDIA AIR Delhi, 9545, often good 1330-1500\* w/EG mx & SAs mx; 31/10 hrd first report of Gandhi's death on this fq (Ernie Behr, Ont)

INDONESIA et al. Report from Kuala Lumpur - R. W. Perry: No, I didn't wind up on the wrong end of a Malay "keris" (dagger), nor did a tiger carry off my radio, nor did the shack become overgrown with tropical flora. So where have I been? Settling in at the new QTH and new job, spending time with the family, seeing the area again. But now the ol' R4B beckons, so I'm ready to get back at it. But lest there be any false expectations, I have no intention to become (nor could anyone) the "JCC" of Southeast Asia, hi. As always, I'll be tuning for the fun of it, and if I find anything interesting, I'll be sure to let my colleagues know about it! A look at the map will give you an idea of what I am treated to here. Sumatra is just a stone's throw across the Straits of Malacca, and as such, quite a few Sumatran RPKD stns are "locals" here, audible far into the mornings and some all day. But the bands are also confused with numerous Thai and local harmonics, weird electrical noises, assorted other stinkers! The shack is in the second floor of my home, a 40-50 year-old colonial home on a hilltop a few minutes out of the heart of downtown KL. An attic antenna was selected after much consideration since the house has been hit by lightning 3 or 4 times over the past few months, and that, coupled with the threat of de-antennating activities by the troupes of local monkeys (most seen at once was three dozen!), made an external wire undesirable. Frankly, since I'm already here in DX-land, an optimal antenna isn't quite the consideration it would be back home . . . Unfortunate

ly for a habitual "morning man" DXer like me, the key time to listen here is in the evening. From 7 pm onwards (1100 GMT) the RPDs are audible until their s/off at 1400/1500/1600 depending on which part of Indonesia, and then the Indian regionals come in, and if one stays up late enough, eventually the Africans and Middle Eastern stns come in when darkness sweeps those areas. Dawn here is about 2300 GMT. The problem with morning listening is that the key target here, the Indos, are hardly worth going after in the local morning since they s/on arnd local dawn and then quickly fade as daylight takes each locality, only the Sumatrans staying audible for any length of time.

4208v-10, RPKD Karo, Kabanjahe, Kab. Karo, Propinsi Sumatera Utara, my best "easy listening" RPD (and David Foster's favorite - see article in 84 WRTH). Comes in all morning up to noontime, and is hrd in the evenings from 1200 t/in to 1500\* and sometimes later. A really funky stn where one can often hear roosters crowing from just outside the stn's windows (presume the creatures are not actually inside, hi), and where fuzzy modulation and persistent microphone feedback are normal features. Supposedly 4110 kc but they drift up and down this range, moving a kc/hr. Local nx at 2350 w/mtns of Deli Serdang, Medan, Sumatera Utara, Prapat, Kabanjahe, and then into wake-up show 2400 with Guy Lombardo-type horn version of "Moonlight Bay" as the theme. Fun selection of Lagu, primarily Elvis songs given an Indonesianized "Ray Confiff singers" treatment, if you can handle that! Infrequent IDs, but have hrd usually on top or bottom of hr, like 1328 or 1400, by man. I often tune my 7600D(2002) portable to this on my balcony for SWLing; stn is about 240 miles away.

3460.3v-3461, RPDT2 Aceh Timur, usually a big, strong sig at night and another daytimer, too. this one must be financially strong judging from the glut of ads always hrd on it. One recent pm, 1000-1030 hrd ads for Brodrex (cold remedy) with Col. Bogey theme; local cinema in Langsa; Susu Ultra ("Ultramilk", which is UHT-treated milk in tetrapak, a process which, by the way, has pushed all other types of cartons/bottles right out of the picture in Malaysia and Indonesia); some ad with jet fighter sound effects selling something unknown (bombs? hi). Sexy Indo ballads by sweet-voiced ladies. Full ID 1028, "Inilah Radio Pemerintah Daerah Tingkat Dua Aceh Timur" by woman.

3316 $\frac{1}{2}$ , RPDT2 Simulungan, Pematang Siantar, Propinsi Sumatera Utara, a rock-solid signal out of this one whenever it's on. Hrd most evenings 1100-1400 and later, tho sometimes off by 1430, and nice in the mornings from, say, 0100 to nominal 0230 s/off --more like 0255. A great music library at this one, and it's a good thing, because anmts are virtually nonexistent. For example 1310-1420 8/11, nonstop lagu pops, and then a fast "bye-bye" anmt and pulled the plug. Ditto 0120-0223\* 11/11. Mumbling W.

3479, unID Indo, the mystery stn hrd even back in Texas but never IDed. Well, is only a matter of time now, but identity still elusive. Hrd most evenings to 1500v\*. Not a bad signal, but suspect not Sumatran as it doesn't quite pack the requisite wallop! Has lengthy Sunday night listeners' ltrs show 1400 to closedown hosted by 2 men and a woman. S/off anmts over keroncong melody, w/M noting "Selamat malam, selamat tidur, sampai sebantar lagi. Inilah Radio Pemerintah Daerah ..???" Ancd kabupatân, phonetically, doesn't match anything I can find, so am going to have to work from other direxion: ID island group, province, and then move to local level. Have many IDs on tape, and none are readable re QTH. Stay tuned, gang.

3121, probable RRI Dili, noted in passing late on a Sunday night, running past 1600 with melancholy and bittersweet keroncong tunes, nonstop. Given keroncong's roots in Portuguese lute, and Timor's background history, no real reason to suspect this not the channel's usual occupant, tho didn't wait for ID ... Will check again, for sake of good order.

Daytime bandscan: Following is sampling of stns audible as daytimers, not exhaustive by any means, indicating those Like a Local (LL), Strong (S), and reasonably good power (OK): 4210v Karo (LL), 3316 $\frac{1}{2}$  Simulungan LL, 3460.3v Aceh Tinur LL, 3241 Sibolga S, 5887 Pekanbaru S, 3232 Bukittinggi S, 3265 Bengkulu LL with Gorontalo no factor here; 4856 Palembang OK, 5052 Singapore LL, 2537 Songkhla, Thailand 2 x 1269 LL, 4032 Melaka 4 x 1008 LL--and the list goes on (Ralph W Perry, K.L., Malaysia)

**SWEDEN** During regular monitoring chex of projected 22m band, anmt from RSI hrd on 13720 at 2209 9/10; unk whether this xmsn was part of a series of test xmsns in 22mb (WBI 18/10) Commenting on above report RSI SCDX pgm 30/10 said it had checked w/STA who said there was no such bc from its xmtrs. The 13 MHz band was not officially open yet and Sweden was not among the countries which had jumped the gun. Since its xmtrs were computer-controlled, there was no question of a technician having programmed the wrong fq on just this one date. The only explanation would be a mistake in identification or a relay from a pirate stn, of which there were of course very many these days (WBI 1/11)

SW SSB relay of Swedish HS pgms, pgm-1 u.o.s. on 100 kW Varberg sender, D84: 0200-0230 11950 0° SD ES. 0230-0300 11950 0° RSI EG. 0630-0800 21550 80°. 0800-0930 Sat/Sun only 21550 110°. 0930-1200 21555 110°. 1200-1600 21555 170°. 1600-1800 15435 170°. 1800-2130 15420 250° [conflicting WRNO]. 2330-2400 11950 0° SD ES (RSI)

VENEZUELA [Cf last month's LN] R Nacional hrd again 3/11 1100-1158\* w/intl svc, and SW call as YVMV or similar. R Rumbos, 9660, booming in from 2000 at 30 over S9, until 0400\* 5/11; never hrd so early, sounds like 50 kW now (Ernie Behr, Ont)

C L A N D E S T I N E S LV del CID on 6299.3, now regular at 0100-1345\*v, vy strong ex-10040, 8/11. In Oct hrd 11680 until 2402\*, moved to 7352.5 to 0300\*, then to 7400 until 1200\*v; all // 10040 & obviously at same site, perhaps Guatemala (Ernie Behr, Ont) Don Moore revisited Cobán, alleged site of CID, but results were inconclusive--no CID sigs hrd at all, so likely off the air during the visit; a weak signal would have put it somewhere else; a strong one likely local (gh)

UNIDENTIFIED New stn on 9510 since 3/11, hrd from 1300 in Farsi or similar lang, many ments of Afgh, to 1359\*. At \*1324 another stn opens on 9510 w/musical IS and AR pgm to 1400\*v, covering the Farsi stn; mentions Iran & seems claud. From 1330 a flutter-jammer on top of both stns some days, and Baghdad is on 9505 in AR at same time. All very confusing & needs further checking (Ernie Behr, Ont) more, IMMI

6590, unID IAm, perhaps claud, hrd 0110-0145 w/SP talks, marches and songs, 5/11 and otherdays, vy weak mod; R Venceremos hrd same time on 6556.7 or 6543v, but much stronger (Ernie Behr, Kenora Ont) See CRANNY; matches R Farabundo Martí

## PUBLICATIONS

The DX Log is one of the best bargains around--irregular but maybe twice monthly publication of the Ozark Mountain DX Club; despite the name, has member/reporters from all over, some abroad. DX monitoring tips in country order running about 4 pages before reduction, from computer printout. Some of the best tips have been quoted in this LN. DX Log itself costs 25¢ an issue--which could hardly cover expenses--and you can subscribe for as many or few as you like, multiplying 25¢. Overseas, I believe, two issues are mailed at once for same price. Edited and published by Mitch Sams, 8515 Scott, Wichita KS 67210. "The DX Log emphasizes rare and difficult DX" (gh)

Shortwave Directory, exciting 2nd edition completely updated and expanded with revised domestic and foreign frequency lists, 1.6-30 MHz. Apx 6000 listings include US, and foreign airforce, navy, CG, army, energy, emergency, state dept, embassies, pirates and clandestines [but NOT SWEC stns in general], aircraft and ships, space, RTTY, facsimile, INTERPOL and much more, all arranged by agency. Bonus--also exhaustive fq cross-reference! Identify those unk stns quickly & accurately! Looseleaf pages drilled for 3-ring binder. \$12.95 includes free bookrate shipping in US and Canada, from Grove Enterprises, 140 Dog Branch Rd, Brasstown NC 28902 (Grove)

Behind the Dial, a forgotten book? Published just 7 years ago by 73 Magazine, has been acquired by Grove Enterprises. Written by Bob Grove, this informative book on monitoring the spectrum is relevant to today's problems and is a 'steal' at only \$3.95 which includes bookrate shipping in US & Canada. Liberally illustrated, it explains in easy-to-understand language, major aspects of listening. Chapters include: The spectrum--who uses it? What are the allocations? How do signals propagate? What is skip, polarization, radiation angle, sky wave and ground wave? What are facsimile, single sideband, radioteletype? Surveillance & security--how does voice scrambling work? What are the most commonly used fqs for bugging? How are covert xmtrs detected? Choosing your equipment--how can you find the best value in a receiver? What are the important characteristics to look for? Which used radios are best? How do scanners work? What are the most effective monitoring procedures? Which accessories do I need? Antennas & feedlines--what are the facts about length, impedance, height and construction? What are the advantages and disadvantages of dipoles, discons, trap antennas, tuners, preamplifiers and switches? How does radio direction finding work? How can you build a directional loop? Interference--how do you recognize motor noise, ignition noise, appliance interference? What simple methods reduce or cure it? A book for today at yesterday's prices, from Grove Enterprises, address above (Grove press releases, with their own superlatives; certain aspects of this book are dated)

Review of International Broadcasting, Oct. issue, still available, includes: Reichsrundfunk Remembered, 4-page verse by Loren Cox, Jr.; via FBIS on controversies in Eu over Luxembourg satellite broadcasting; Domestic Information and Associated Listening --DIAL, new column by Kraig W Krist; Listener Insights on Programming; Radio Equipment Forum on antenna accessories, etc.; The World Thru an R-70 by Paul Gilster; complete BBC pgming for Dec incl Xmas spl; English skeds; sample \$1.50, 12-issue subscription \$18 from RIB, Box 490756, Ft Lauderdale FL 33349; Canada: \$1.75 / \$21 US.

LAST MINUTE, LAST MINUTE ITEMS AFGHANISTAN R Afgh to Eu 1730-1930 now on 7320 & 5905, incl Pashto & Dari 1730-1830, GM 1830-1900, EG 1900-1930. The 1930-2000 bc in FR hrd briefly 8/11 on 5905 just before xmtr switchoff; anmt said this on 11830 & 7200, but not traced eitherwhere; AR svc 1700-1725 so far hrdon 9575 only (WBI)

CHINA PLA Fujian Front Stn, Voice of the Strait (Std. Chinese: Hai-xia-zhi-sheng guang-bo dian-tai), to offshore islands & Taiwan, Pgm I in Std CH & Amoy at 0955-2355: 0955 on 7850 6765 5900 5265 5240 4045; 1130 on 5900 5265 5240 4330 4045 2490. 1230 on 5265 5240 4330 4045 3200 2490. 1310 on 4330 4045 3640 3535 3200 2490. 1900 on 3640 3535 3200 2490. 2130 on 4330 3640 4045 3535 3200 2490; all + MW. 2nd pgm, 0355-1800 in Std CH & Amoy: 0355 on 11590 9505 7280 7025 6400 6000 4380. 0800 on 9505 7280 7025 6400 6000 4840 4380. 0845 add 5170; 0900 add 5770. 1030 on 7280=to 1100 7205 6400 6000 5770 5170 4840 4380 3400 2800=from 1100. 1200 on 5770 5170 4840 4380 3900 3400 3300 2800 2600 2430. 1300 on 4840 4340 4130 3900 3400 3300 2800 2600 2430. 1340 on...same (WBI 15/11)

FRANCE RFI reported that on 8/11 the For Affairs Minister presented the French External Rels budget for 1985 to the Natl Assembly. It was an austerity budget, with cuts in all areas exc extl being. Per FAM, RFI's total budget'd be increased from 296 to 335 megafrancs in 1985, whereas in 1981 it had been only 137 MF. This'd allow for improvements to the 24h svc which started in 1984 as well as for boosting the power of the Montsineryrelay stn (French Guyana[sic]) which now covered the whole of LAm. Increased budget allocation'd also improve chances for success in talks which RFI was having w/DW on use of relay stn in Sri Lanka to cover FE, S&SEAs (WBI 15/11)

GERMANY EAST Current RBI sked for D84 & M85 shows svc in SP to Eu introed; 1915-2000 on 9730 7295 7260 7185, replacing a PT xmsn; previously, RBI in SP to LAm only

GHANA GBC reported that on 7/11, the Secretary for Info had inspectd construction work for installation of three new 50 kW xmtrs for GBC in Accra. Installation was to replace old 10 kW xmtrs now in use. Secy for Info called on GBC staff to work hard for the nation to rx a better svc and to ensure that the wiring for the new eqp'd be safe enough to prevent thieves from stealing it. GBC Dir of Eng explained that the actual installation work would commence in Jan 85 and be completed within four months. He said this'd enable all parts of the country to rx continuous svc w/out breaks in xmsn. Dir of Engineering also appealed to govt to supply GBC w/asbestos roofing sheets so that the project 'd be completed on time (WBI 15/11) Ah, good ole 3rd World, where asbestos still OK; presumably SW as no MW there (gh)

ISRAEL VOI AR svc for Israel & Arab World (Net D) now on 5915 //MW & FM; former fq 7465 now relays HB svc Net-B 0400-0615 & 1745-2315 (WBI 15/11)

JORDAN Per recent edn of Jord npxpaper The Jerusalem Post [sic], new radio stn to be built nr present one in Amman. HC's'd be in AR & EG and stn'd be rxd in all world-parts; no further details (WBI 15/11)

NETHERLANDS RN has published info on further Flevo aite tests, replacing Lopik as follows: 3-14 Dec, all bcs weekdays 1430/2125. 17-27 Dec, all bcs weekdays exc on 25/12 & 26/12 1430-0625. 2-11 Jan, all bcs on weekdays 0700/1425. Fqs used for RN EG during Flevo test'd be: 3-14 Dec: 1430 17605 SAs, 2030 11730 Waf. 17-27 Dec: 0230 9895 ENAm, 0530 9895 ENAm[sic], 1430 17605 SAs, 2030 11730 Waf. 2-11 Jan: 0700 on 11930 9895 9630 5955 W&NWaf/Eu. 0930 15560 11930 9895 5955 ME/UK/Eu. 1330 on 17605 11935 9895 5955 UK/Eu. Flevo xmtrs'd take over all xmsns from Lopik between 1125 & 0830 from 14/1 to 31/3/85, when a new xmsn sked'd be introed. Between 3 and 27 Dec (weekdays exc 25/12 & 26/12), 1830 EG on 6020 from Lopik as at present but probably w/100 kW stead of 10 kW. MN pgm 8/11 reported Flevo using Dynamic Amplitude Modulation--DAM-- in which carrier power reduces during brief intervals when modulation absent or low, thus saving energy costs. This plus other power-saving techniques meant that while Flevo would have five times the power out put of Lopik, the energy bill'd only rise by about 2½ times. RIAS surveys showed DAM decreased their energy costs by 25%. Telefunken established that max redunxion of about 65% of carrier power would not cause deterioration of audio quality. 13/11 obs of Flevo tests showed 13670 used from +1430-1655, //21570 11915; 13670 also 1730-1755 & 1800-1825 (WBI 15/11)

NEW ZEALAND [Cf main sexion; BBCMS reports about the same but adds:] However, 12/11 & 13/11 opening & closing anmts are still "SW svc of RNZ" rather than "RNZ International (WBI 15/11)

SUDAN [Cf main sexion] R Cairo reported 12/11 that Sudan & Japan'd signed agreement to improve Sudanese radio xmsns. Japanese firm'd be undertaking consultancy work. The first stage, which'd be financed by Japanese aid, 'd involve 5 xmtrs to be insta

lled in the areas of 'Atbarah, Kassala, Al-Ubayyid, Dunquiah and Wad Madani. This expected to begin after contract signed w/company winning tender, TBA next March. Also then, studios'd begin on 2nd stage for improving radio xmsns in Sudan, similarly involving five areas: Kaduqil, Port Sudan, Al-Damazin, Al-Fashir and Wadi Halfa. By means of xmtrs in various Sudanparts, bcs'd be clearly audible across Sudan during day and in nearby countries at night. This'd usher in 3rd stage - beaming of bcs a-broad on SW, using two 300 kW xmtrs (WBI 15/11)

U S A WRNO on 9852.5 still has Farsi cland pgm at 0000-0100\* GMT Mon; ID "R Seday-e Azadee" or "R Voice of Liberty", ancd New York address; first noted in July on 9705 at 2300 (Ernie Behr, Ont)

U S S R 7/11, RM coverage of parade in Red Square commemorating anniv of GOSR consisted of a live reportage in RS for listeners at home and abroad. Commentaries on the parade were also bc in FR & EG for ES audiences. Live RS, audible on some 50 SW channels betw 5900 & 21750, began at 0650 on all DS and 5th Pgm for seamen & compatriots abroad, which had all linked up at 0630; ended at 0900. RMWS EG commentary at 0650-0817 on 28 SW channels; FR R Moscow Int'l svc stayed on air beyond normal 0700\* to 0815 w/parade on some 14 SW fqs, and until 0900 w/wx (WBI 15/11) Next: May Day

VIETNAM VOV ES has replaced 15010 by 12020 from 1100 to 2300 (WBI 15/11) incl EGs

CLANDESTINE V of the Unity (Pashto: De Wahdat Ghazah; Dari: Sada-e Wahdat), hostile to govt of Afgh & Soviet involvement, at 0130-0230 on 11640 9680; 1530-1630 on 15050 11630. First hrd May/June 1980; addr for listeners letters given as P O Box 507, 1010 Vienna, Austria. Stn formerly known as V of the United Muslim Fighters (Mojahedin) of Afghanistan (WBI 15/11)

UNIDENTIFIED - 9510 [Further to the report 2 pages back] Strange activity on 9510 is getting even more confused: AR cland no longer opens at 1324; 12/11 hrd same stn on 9511, but in Farsi from \*1300 w/ID "Seday-e ..." 1327 sung anthem, 1329 AR pgm to 1400\* w/ID "Sawt ath-Thowrah al-Islamiyah...Iraq or Iran". The other stn was still on 9510, from 1300 in Farsi or similar to 1359\*, also w/ID "Seday-e ..." & mentions of Islam & Afgh. Both stns equally strong; weak QRMoscow in CH also on 9510 (Ernie Behr, Kenora Ont, 12/11)

THANK YOU, to those who have sent wishes for quick recovery from broken ankle. Cast is off, and it is well on the way to healing, tho still limping somewhat (gh)

ANYTHING below this line is not part of LN. Until the next, 73 de Glenn

-----

The offer below is good only until January 2, 1985...

SPECIAL PRE-PUBLICATION OFFER

Announced by

GILFER SHORTWAVE

52 Park Avenue, P. O. Box 239, Park Ridge, N. J. 07656 (Area Code 201 391-7887)

Park Ridge, NJ --GILFER SHORTWAVE is pleased to announce the availability of its annual special pre-publication price for the upcoming 39th Edition of the "World Radio TV Handbook", as follows:

World Radio TV Handbook - \$15.50 shipped bookmail  
\$17.00 shipped UPS

World Radio TV Handbook +  
Confidential Frequency List-6 - \$27.50 shipped bookmail  
(both shipped upon WRTVH release in January) \$29.00 shipped UPS

We accept Visa or Mastercard (Minimum order \$20.00)

...and please mention FRENDX. Thanks.

# QSL REPORTS

Sam Barto  
47 Prospect Place, Bristol, CT.

USA 06010



**ALASKA:** KNLS 11850 f/d ltr. in 17 ds. v/s Francis M. Perry. (Barrera-ARG).

**ALBANIA:** Radio Tirana 11985 f/d cd. w/ badge in 110 ds. Schedule rcvd. (Warner-AUST).

**ALGERIA:** RTVA 17745 f/d "Tapestry" cd. in 63 ds. for 2 IRCs. (Church-VT). same in 25 ds. for a FR rpt. (Levison-PA). in 26 ds. for 2 IRCs. (Hart-FL).

**ANGUILLA:** Caribbean Beacon 1610 f/d cd. in 84 ds. for 2 IRCs. v/s Gareth Hodge. (Paszkwicz-WI).

**ANTARCTICA:** LRA36 Radio Nacional 15474 f/d cd. in 84 ds. for 2 IRCs.

**ANTIGUA:** Deutsche Welle 9690 n/d "Logo" cd. in 3 mo. (Orcutt-NY). BBC 6175 n/d cd. in 20 ds. (Renfrew-NY).

**ARGENTINA:** RAE 15345 f/d ltr. w/ "Globe" cd. and pennant in 48 ds. for a SP rpt. and 2 IRCs. v/s Sonia Rojas. (Brouillette-IL). same w/ pennant in 44 ds. for a SP rpt. (Levison-PA).

**ASIATIC RUSSIA:** Radio Moscow 15150 via Chita f/d "Hotel Rossiya" cd. in 37 ds. (Streeter-NY).

**AUSTRALIA:** VNG 7500 n/d folder cd. in 56 ds. for 1 IRC. (Lawrence-CO). Radio Australia 9580 via Shepparton f/d "David Gulpilil" cd. in 25 ds. (Cones-VA). 15320 f/d "Koalas" cd. w/ poster in 32 ds. (Brouillette).

**AUSTRIA:** ORF 5945 f/d "Winepress" cd. in 60 ds. (Renfrew).

**BELGIUM:** BRT 5910 cd. in 24 ds. (Levison-PA). 21460 f/d "Harmonic Filter" cd. w/ pennant and sticker in 23 ds. (Cones-VA). 9925 cd. in 31 ds. (Levison). f/d "Bruges" cd. in 33 ds. (Dillon-DC). 17610 f/d "Hospice" cd. in 18 ds. w/ schedule. (Dillon-DC).

**BELIZE:** Radio Belize 3285 p/d "Map" cd. in 14 ds. for 2 IRCs. 1kw power. (Lawrence-CO).

**BOLIVIA:** CP222 Radio San Jose 5985 f/d cd. w/ 2 page ltr. in 44 ds. w/ pennant for a SP rpt. and ms. v/s Daniel Ordonez Plaza, Secretary General. (Reinstein-FL)....Steve, send me a photocopy of the pennant for the column...Sam.

**BRASIL:** Radio Nacional 15270 f/d cd. in 33 ds. (Levison-PA). Radio Cultura Araraquara 3365 cd. w/ sticker in 25 ds. for a PT rpt. and ms. (Foxy-VA). Radio Por um Mundo Melhor 4855 ltr. in 17 ds. for a PT rpt. and ms. v/s Marcia Regina. (Streeter-NY). Radio San Carlos 2420 p/d personal ltr. in 78 ds. for a PT rpt. and 2 IRCs. v/s Lillian M. Keppe Rossi. (Barrera-ARG).

**BULGARIA:** Radio Sofia 9700 f/d "Bachkovo Monestry" cd. in 37 ds. (Levison-PA). f/d "Nessebur" cd. in 100 ds. w/ sked. (Cones-VA).

**CAMEROON:** Radio Douala 4795 f/d "World Map" cd. in 13 mo. for an EG rpt. and 2 IRCs. v/s A. Nsima. (Lare-MI).

**CANADA:** RCI 15325 f/d "Jacques Cartier" cd. in 30 ds. (Renfrew-NY). BBC 9510 n/d cd. in 20 ds. (Renfrew). CHU 3330 n/d cd. in 33 ds. (Erwin-VA).

\* CRZU 6160 f/d cd. in 10 ds. for 1 IRC. (Lawrence-CO). CFPB 6065 via CBCNS n/d ltr. direct from CFPB in 1 mo. for ms. v/s David R. Crew. (Orcutt-NY). CFRX 6070 f/d cd. in 22 ds. for 1 IRC. (Richards-CT).

**CANARY ISLANDS:** REE 15365 f/d cd. w/ sked. in 57 ds. (Hart-FL).

**CAPE VERDE ISLANDS:** Radio Voz de Sao Vicente 3930 f/d cd. in 20 ds. for a PT rpt. and 3 IRCs. (Foxy-VA). same in 1 mo. v/s N. Fortes. (Berg-MA).

RADIO DEPORTIVA HANDICAP. C. POR A.

QSL COLUMN REPORT FORMS  
ARE AVAILABLE FROM  
YOUR EDITOR FOR AN SASE

VOUS AVEZ ENTENDU USTED ESCUCHO YOU LISTENED		T. I. L. X.
<b>CADENA de EMISORAS COLUMBIA</b>		
APARTADO 708 - SAN JOSE, COSTA RICA.		
TO S.W.L. - <u>4825</u> <u>3300</u>		WE ACKNOWLEDGE YOUR RECEPTION
OF RADIO COLUMBIA ON <u>4825</u>		KHz. At <u>4825</u> HRS-LOCAL, GMT
DATE <u>10/10/83</u>	IN <u>83</u>	THANKS FOR YOUR QSL CARD. 73
Technical Data: Xmit FWH <u>15</u>		KW Antenna <u>1000</u>
Other used frequencies:		Other stations:
760, 1080, 1140, 1240, 1320		1400 and 1520 KHz.
NEWS - SPORTS - RADIO THEATER - ENTERTAINMENT AND EDUCATIONAL PROGRAMS		



1111 R  
CALLE  
ONNA LARGA

Ciudad Trujillo  
REPUBLICA DOMINICANA  
Apertado 81 - Tel. 9 6291

11121 R  
CALLE  
BARRIO DE...



SOKOTO STATE BROADCASTING CORPORATION

Telegrams & Cables  
RIMACASTS, SOKOTO  
Phone: 232450, 232100  
Telex: 73116

RIMA RADIO,  
P.M.B 2156,  
SOKOTO,  
NIGERIA

23rd March, 1984.

SK/PRG/309/VOL.1/3

Mr. Christopher R. Lobbell,  
P. O. Box 146,  
Steneham,  
Massachusetts 02180,  
U. S. A.

RECEPTION REPORT

With reference to your letter dated 3rd February 1984,  
I wish to confirm that it was our station you received. We  
are indeed happy for the letter and the reception report  
attached to it.

It is unfortunate that your earlier letter was not  
received but your prepared Q.S.L. card that accompanied  
your latest one had been received and posted to you earlier.

I would like to thank you once more.

Yours faithfully,

(S. A. Akande)  
for: Controller of Programmes  
Rima Radio,  
Sokoto.

- \* ner-AUST). Radio Antorcha Martiano 7077 ltr. v/s Luis A. Crespo, Secretario General. Addr: P.O. Box 440491, Miami, FL. 33144. (Berg-MA). La Voz de Nicaragua Libre 5750 prepared cd. for 3 rpts. over 9 mo. Addr: ARDE, Apto. 348, Pavas, San Jose, C.R. (Berg-MA).
- COLOMBIA: Radio Macarena 5975 f/d cd. w/ sticker in 3 wks. for a SP rpt. and ms. (Yamron-PA). in 16 ds. w/ stickers for a SP rpt. and ms. v/s Enrique Zambrano Nieto, Gerente. (Forsgren-WI). La Voz del Centro 6095 3 page ltr. w/ prepared cd. after 1 yr. and 4 rpts. v/s Nestor Giraldo Aristizabal, Director. (Berg-MA). Radio Cinco 5040 prepared cd. in 2 yrs. for 6 rpts. in SP v/s Guillermo Morales M., Director. (Berg-MA).
- COSTA RICA: Radio Casino 5954 f/d cd. w/ pennant in 6 wks. for a SP rpt. and 2 IRCs. (Yamron-PA). same in 5 1/2 mo. for a SP rpt. and ms. (Niekamp-MN). TIFC 5055 f/d cd. in 30 ds. for 3 IRCs. v/s Juan Jacinto Ochoa F., Director. (Renfrew-NY). Emisoras Columbia 4825 p/d cd. in 24 ds. for a SP rpt. (Barrera-ARG).
- CYPRUS: CBC 6030 f/d cd. in 149 ds. for ms. (Foxx-VA). same in 225 ds. for 2 IRCs. (Cassidy-IN). f/d cd. in 259 ds. for 2 IRCs. (Cones-VA).
- CZECHOSLOVAKIA: Radio Prague 5930 f/d "Puskevny" cd. in 40 ds. (Renfrew-NY). cd. in 28 ds. w/ schedule. (Hart).
- DENMARK: Radio Denmark 15165 f/d "Painting" cd. in 15 ds. (Lawrence-CO).
- DJIBOUTI: RTV Djibouti 4780 p/d "Logo" cd. in 112 ds. for 3 IRCs. (Barrera) same in 27 ds. for a FR rpt. and 2 IRCs. (Streeter-NY). in 303 ds. for a FR rpt. and 2 IRCs. (Cones-VA).
- ECUADOR: HCJB 9745 f/d "Indigenous People of Ecuador" cd. in 1 mo. for ms. (Orcutt-NY). 15155 same cd. in 40 ds. for 1 IRC. (Renfrew-NY).
- \* Radio Panamerica 3295 no QSL after 8 rpts. over 29 mo. but a friend in a nearby MA. town who knew the owner was given a pennant to bring back to me from Ecuador. (Berg-MA). I guess they say nice but no cigar. It happens to all of us. Keep trying.

CAPE VERDE ISLANDS: Emissora

\* Oficial 7155 ltr. and postcard in 6 wks. v/s Antonio Pedro Rocha, Director de EORCV. (Berg-MA).

CHAD: RNT 4904 f/d ltr. in 45 ds. for a FR rpt. and 2 IRCs. v/s Danrhet Qualbadet. (Swaringen-NC) in 83 ds. for a FR rpt. and 3 IRCs. (Hart-FL).

CHINA, PEOPLES REP. OF: Radio

Beijing 15520 f/d "Great Wall" cd. w/ pennant in 42 ds. (Brouillette-IL). in 18 ds. (Levison-PA). 15520 and 11650 cds. in 22 ds. w/ pennant for a taped rpt (Richards-CT). Gansu PBS 4865 f/d cd. in 65 ds. for a CH rpt. (Barrera-ARG).

CLANDESTINE: Radio Camilo Cienfuegos

6320 f/d "CID" cd in 3 wks. for a SP rpt. & ms. (Orcutt-NY). 10040 same cd. in 22 ds. for a SP rpt and 2 IRCs. v/s Bernardo Morell. (Barrera-ARG). in 37 ds. for a SP rpt. (War-) in 22 mo. for a SP rpt.



Q.S.L.

Dear \_\_\_\_\_

Thank you for your Reception Report dated \_\_\_\_\_ for the broadcast on \_\_\_\_\_ at the frequency of \_\_\_\_\_ at the time of \_\_\_\_\_

We hope you will try again in the near future.

73's *J. J. Harley*

P.O. BOX 1637 - WASHINGTON, D.C.

TRIPLE - F - MUSIC

VOIX DE LA RÉVOLUTION  
RADIODIFFUSION NATIONALE  
B.P. 617 CONAKRY  
République de Guinée

Vérification du Rapport

d'écoute  
De General Juan Barros  
Carilla 2818 - CC -  
Lima, Buenos Aires  
Argentine

Cher auditeur

C'est avec plaisir que nous avons reçu votre rapport d'écoute de nos émissions du 24 Nov. 1958 entre 1900 et 2042 heures GMT, sur la fréquence de 4530 KHz soit 49 ...

Notre programme confirme l'exactitude de votre rapport d'écoute qui nous a par ailleurs beaucoup intéressé

*Non vos amuses très reconnaissable  
faut d'attention que vous faites à  
notre station*  
*Marc*

Nous vous donnons ci-dessous le programme actuel de nos émissions.

A.M. - m	GMT
1803-214	
1910-50	
2125-41	
0630-31	
15210-19	
2114 f-4 g	
114 f-2 j	

En espérant vous relire très bientôt, nous vous prions d'accepter nos vifs remerciements et nos salutations amicales.

La Direction du Bureau d'Etudes

*P. G. G. G.*

**ECUADOR:** La Voz del Upano 5040 ltr. w/ pennant in 6 wks. for a SP rpt. (Berg-MA). Radio Nacional del Ecuador 15115 via HCJB prepared cd. in a total of 14 mo. for 5 rpts. in SP (Berg-MA). Radio Jesus del Gran Poder 5050 n/d folder cd. in 3 1/2 mo. for a SP rpt. and ms. (Niekamp-MN). same w/ pennant in 134 ds. for a SP rpt. and ms. (Warner-AUST). cd. w/ pennant in 77 ds. for a SP rpt. (Barrera-ARG).

**ENGLAND:** BBC 5975 n/d cd. in 20 ds. (Renfrew-NY). Spectrum World Broadcasting 7710 cd. w/ ltr. stating that my rpt. was the only one rcvd. from the US; v/s G. Sinclair. (Berg) \* MSF 5000 f/d cd. in 10 ds. for 1 IRC. v/s B.R. Swabey. (Cones-VA).

**EQUATORIAL GUINEA:** Rdf. Television de Guinea Ecuatorial 6250 p/d personal ltr. in 180 ds. for a SP rpt. and \$1.00US. v/s Matias Ovono Engonga Nsanga. (Reinstein-FL). **FRENCH GUYANA:** RFO 5055 f/d "Logo" cd. in 38 ds. for a FR rpt. and 2 IRCs. (Barrera-ARG).

**GABON:** Africa No. 1 4811 p/d "Logo" cd in 8 mo. for a FR rpt. and 3 IRCs. (Niekamp-MN).

Radio Japan via



Africa No. 1 15405 cd. w/ sticker in 9 mo. after a f/up rpt. v/s M.A. Guy. (Berg-MA).

**GERMAN DEMOCRATIC REP:** Radio Berlin International 9620 f/d "Alfred-Brehm-Haus" cd. in 66 ds. (Dillon-DC).

**GUATEMALA:** La Voz de Nahuala 3360 f/d cd. w/ personal ltr. in 19 ds. for a SP rpt. and ms. v/s Juan Fidel Lepe Juarez. (Streeter-NY). same in 26 ds. for a SP rpt. and ms. (Foxy-VA). f/d cd. in 1 mo. for a SP rpt. and ms. (Forsgren-WI). Radio Cultural 3300 p/d "Quetzal Bird" cd. in 35 ds. for 2 IRCs. v/s Wayne Berger, Chief Engineer. (Hart-FL).

**GUYANA:** GBC 5950 f/d ltr. in 30 ds. for 1 IRC. v/s Miss Phyllis Hyles. (Renfrew-NY).

**HAITI:** Radio 4VEH 4930 f/d cd. in 7 mo. for 1 IRC. (Niekamp-MN). VA.

**HAWAII:** WWVH 10000 f/d "Outrigger" cd. in 12 ds. v/s C.L. Trembath (Erwin-CO). Radio Luz y Vida HRPC 3250 f/d ltr. w/ pennant in 67 ds. for a SP

\* rpt. and 1 IRC. v/s Donald R. Moore, Director. (Cones-VA). Radio Landia 4965 f/d postcard via our own Don Moore who visited the station. v/s Leonell Andino U. (Berg-MA).

**HUNGARY:** Radio Budapest 9835 f/d cd. in 69 ds. w/ postcards. (Levison-PA).

**INDIA:** AIR Hyderabad

4800 cd. w/ site in 14 wks. v/s H.O. Agarwal, Director of Frequency Assignments (Berg-MA).

**IRAQ:** Radio Baghdad 3368

via Salman Pak and 7180 via Abu Ghrar f/d cd. in 101 ds. (Warner-AUST).

**IRELAND:** Radio Dublin

International 6910 f/d cd. in 110 ds. v/s Anne Kelly. (Rigas-IL).

radio **DX PROGRAMME 25 Years**  
**Sweden international**

LA NORTH AMERICA  
LA SOUTH AMERICA  
LA ISRAEL AUSTRALIA

**RTK**

The Broadcasting Company of Northern Nigeria Limited  
 P. O. BOX 250, KADUNA,  
 NORTH CENTRAL STATE, NIGERIA.

Telegram: Radionorth Kaduna.  
 Telephone: Kaduna 2294.

GPI/JSE/R.1

27th October, 1969

C. Vernon Hyson,  
 10 Stanford Dr. A3  
 Somerville, N.J. 08876  
 United States of America

Dear Sirs,

With reference to your letter of  
 12th October, 1969 regarding a reception report  
 of our shortwave transmission on 6090 kHz between  
 0435 to 0503 hours GMT.

We confirm that this was our station.

We enclose some literature which may  
 interest you.

Thank you.

Yours faithfully,

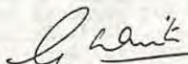
  
 G.P.J. WHITE  
 Chief Engineer

**IRELAND:** World Music Radio 6910 via REDI f/d cd. in 136 ds. v/s Lee Alvin. (Paszkiewicz-WI). f/d cd. in 142 ds. for 2 IRCs. (Warner-AUST)  
**ITALY:** RAI 9575 f/d cd. in 232 ds. (Forsgren-WI). Radio Manila 7215 f/d form ltr. w/ sticker in 60 ds. for a taped rpt. and 2 IRCs. 60 watts! (Warner-AUST).  
**JAPAN:** Radio Japan 15300 f/d cd. in 16 ds. (Levison-PA). 15300 & 17825 cds. in 15 ds. \* (Levison). RCI 6055 via NSB f/d cd. w/ RCI stamp, sticker & pennant in 65 ds. v/s S. Phillips and A. Sigematsu. (Warner). \* NHK 6130 via Kumamoto p/d personal ltr. in 17 ds. direct from station. Addr: 2-7 Chibajo-Machi, Kumamoto 860. (Warner).

**VERIFICATION SIGNERS:** Radio Anhanguera 4915 Maria Lucia de Brito. Radio TV Gaucha 11915 Flavio Fleck, Radio Technician. Radio Mondou 5288 Dorong Guera Ketchoua, Director. Radio Nacional 15474 Carlos Alberto Gherardo Morone, Jefe. Radio Atlantida 4790 Juanita Rojas M. Radio Amazonas 5060 Erwin Rengifo Rios, Gerente. Bavrak Radio 6149 Neshet Erkman. Radio Andahuaylas 4840 Daniel Andreu Casafranca, Director Gerente. A Voz de Oeste 4775 Celso Castilho. La Voz de la Selva 6170 Jairo Ernesto Paredes Guerrero, Gerente. La Voz del Llano 6117 Gloria Rodriguez. Radio Catolica Nacional del Ecuador 5055 Padre Cirillo Pescaroli, Director.

\* NHK 3259 via Sendai p/d cd. via Radio Japan in 23 ds. (Warner-AUST).  
FEN 11750 f/d "Logo" cd. in 30 ds. (Barrera-ARG).  
**KUWAIT:** Radio Kuwait 9840 f/d "Logo" cd. in 93 ds. for an AR rpt. (Barrera-ARG). same in 33 ds. w/ sticker for 3 IRCs. (Foxy-VA).  
**LEBANON:** King of Hope 6215 f/d cd. in 15 ds. for 2 IRCs. (Barrera-ARG).  
**LIBERIA:** LBS 6090 f/d cd. in 62 ds. for 2 IRCs. (Barrera-ARG).  
**LIBYA:** Radio Jamahiriva 15450 f/d "African Service" cd. via Malta in 6 wks for 2 IRCs. (Orcutt-NY).  
**LITHUANIA:** Radio Vilnius 15100 f/d cd. in 4 mo. for 1 IRC. (Niekamp-MN).  
**LUXEMBOURG:** Radio Luxembourg 6090 p/d cd. in 20 ds. (Renfrew-NY).  
**MALAGASY REP:** Radio Nederland 9715 f/d cd. in 46 ds. (Richards-CT).  
**MONACO:** Trans World Radio 6210 via Mt. Agel f/d cd. in 55 ds. for 1 IRC. (Cones-VA).  
**MOROCCO:** RTM 17595 f/d "Map" cd. in 81 ds. for \$1.00US v/s J. Tanase. (Jones-VA).  
**NAMIBIA:** Radio SWA 3295 f/d "Sossosvlei" cd. in 156 ds. for 1 IRC. (Dillon-DC). same in @ 1 mo. (Levison-PA). 3270 f/d "Nature Park at Namib" cd. in 5 mo. for 2 IRCs. (Lare). f/d cd. in 1 mo. for 3 IRCs. (Yamron-PA).  
**NEW CALEDONIA:** Radio Noumea 7170 p/d cd. in 4 mo. for a FR rpt. (Barrera-ARG).  
**NEWFOUNDLAND:** CKZN 6160 f/d cd. in 37 ds. v/s D. Uttaro. (Erwin-VA).  
**NICARAGUA:** Radio Sandino 6200 p/d form ltr. \* in 3 mo. for a taped rpt. v/s Maria Eugenia Urroz, Relaciones Internacionales. (Berg-MA).

**HRVC LA VOZ EVANGELICA**

1390 kHz 103.5 mHz  
 4820 kHz 5000 Watts

1100--0300 GMT Spanish  
 0300--0500 GMT English

Frequency 4520 KHz

Dear Friend, Joe Talbot

Thank you for your report of

June 26, 1963

0415 GMT to 0445 GMT

We gratefully acknowledge your reception of HRVC.

Signed Cindy's Maracay

**RADIO RSA**

Die Stem van Suid-Afrika



**NIGERIA:** Radio Plateau 5965 via Jos f/d ltr. in 7 mo. for 2 IRCs. v/s F.O.N. Dike.(Lare).  
 \* Voice of the Gospel 11815 via ANO ltr. from Mrs. E. Mbodwam, Aud-

ience Relations who does not encourage rpt. because of limited funding resources. ltr. in 2 mo. Addr: P.O. Box 287, Jos.(Berg-MA).

**NORWAY:** Radio Norway 9645 f/d cd. in 43 ds. w/ sticker.(Levison-PA).

**PAPUA NEW GUINEA:** Radio Enga 2410 p/d personal ltr. in 69 ds. v/s Lloyd Guvil, Station Technician.(Warner-AUST). Radio West New Britain 2340 ltr. in 37 mo. v/s A. L. Rumuhas.(Berg-MA).

**PARAGUAY:** Radio Nacional 9735 p/d form ltr. in 32 ds. for a SP rpt. and 2 IRCs. v/s Carlos Montaner, Jefe Tecnico.(Brouillette-IL). same in 1 mo. for a SP rpt.(Levison-PA). in 6 wks. for a SP rpt.(Yamron-PA).

**PERU:** Radio Los Andes 5030 f/d cd. w/ personal ltr. in 118 ds. for a SP rpt. and ms. v/s Pablo Jacob Cardenas Valverde, Gerente General.(Reinstein-FL). same in 4 mo. for a SP rpt. and ms.(Orcutt-NY). Radio Nor Peruana 9655 f/d form ltr. w/ prepared cd. in 2 mo. for a SP rpt. and ms. v/s Augusto Roca Garcia, Jefe.(Orcutt-NY). Radio del Pacifico 9675 f/d ltr. in 35 ds. for a SP rpt. and 2 IRCs. Sticker revd. v/s J. Petronio Allauca.(Hart-FL). Radio Quillabamba 5025 ltr. w/ prepared cd. and pennant in 31 mo. after 9 rpt. in SP. v/s Rufino Lobo Alonso O.P., Director.(Berg-MA). Radio Libertad de Trujillo 4911 ltr. w/ cd. in 3 wks. for a SP rpt. v/s Carlos Burmester B. Addr: Zepito No. 450, Casilla 712, Trujillo.(Berg-MA). Radio Chinchaycocha 4860 ltr. w/ postcard in 31 mo. for a SP rpt. v/s Julio O. Baldeon, Administrador.(Berg-MA)...Verie nice selection...Sam.

**PHILIPPINES:** VOA 6110 via Poro f/d cd. in 24 ds.(Lawrence-CO). Radio Veritas 11955 f/d cd. in 29 ds. for 2 IRCs.(Lawrence-CO).

**PORTUGAL:** Radio Portugal 6075 f/d "Triptico" cd. in 20 ds.(Renfrew-NY).

**QATAR:** QBS 9905 f/d "Logo" cd. in 6 wks. for 2 IRCs.(Orcutt-NY).

**RIO MUNI:** Radio Nacional Bata 4926 f/d cd. in 70 ds. for a SP rpt.(Barrera-ARG)

**ROMANIA:** Radio Bucharest 15335 f/d cd. w/ pennant in 64 ds (Warner-AUST).

**RWANDA:** Deutsche Welle 17800 n/d cd. in 41 ds.(Levison-PA).

**SABAH:** RTM 5980 via \* Kota Kinabalu f/d "Map" cd. in 110 ds for 1 IRC(Warner).

**SAIPAN:** KFBS 11775 f/d "Map" cd. for a RR rpt. and ms.(Barrera-ARG).



  
**CR6R**  
**RADIO-DIAMANG**  
**CR6R**  
**DUNDO ANGOLA**



WROCLAW The City Hall

RADIO POLONIA

**SAIPAN:** KFBS 15115 f/d cd. in 6 mo. (Warner).  
**SAUDI ARABIA:** BSKSA 15345 f/d "Logo" cd. for an AR rpt. (Barrera-ARG).  
**SEYCHELLES:** FEBA 15200 f/d "Map" cd. w/ sticker in 102 ds. for ms. v/s P. Elizabeth, QSL Secretary. (Foxx-VA). 15325 f/d cd. in 78 ds. for 3 IRCs. (Barrera-ARG).  
**SICILY:** RAI 7175 Caltanissetta f/d cd. in 250 ds. for 1 IRC. (Swaringen-NC).  
**SINGAPORE:** Radio Singapore 11940 f/d cd. in 29 ds. for 2 IRCs. (Lawrence-CO). 6155 f/d cd. in 1 mo. for 2 IRCs. (Yamron-PA).  
**SOUTH AFRICA:** Radio RSA 6010 f/d "Bloubergsstrand" cd. in 28 ds. v/s Collin Miller. (Paszkiwicz-WI). 9615 same cd. in 15 ds. w/ pennant for 1 IRC. (Jackson-IN).  
**SWAZILAND:** TWR 5055 f/d folder cd. in 6 wks. for 2 IRCs. (Yamron-PA).  
**SWITZERLAND:** Red Cross Broadcasting Service 11715 f/d "Globe" cd. in 8 wks. for 1 IRC (Swaringen-NC). SRI 6135 f/d cd. in 30 ds. (Renfrew-NY).  
**SYRIA:** Syrian Arab Republic Broadcasting Ser-

\* vice 12085 f/d "Logo" cd. in 110 ds. for 2 IRCs. v/s Mrs. Awatef Haffar. (Cones-VA). same in 105 ds. (Rigas-IL).

**NOTES:** Received a nice letter from Brian Lawrence. He is a new contributor to our Column. Rav Niekamp reports that the winter seasons is starting to arrive in Minneapolis. Time to tune the dials. Peter Dillon in D.C. says that his DXing has shrunk to a few hours on the weekend. Thanks for the wishes...Sam. Larry Yamron in Pittsburgh recently got back into the hobby after a 9 year absence! Great to have you back Larry. Brian Glasgow of Worcester, MA. is another new reporter to the Column. He works at the WPI bookstore in town. Ron Howard in Santa Barbara send his best to everyone. Robert Sobkoviak in Plainfield, IL. wishes

he could of attended ANARCON-84 in Toronto. You really missed a great time...Sam. Ted Habak is yet another new contributor. He says he will be reporting as often as he can. Bill Plum in

Irvington, NJ reports that the DXhas been sparse down his way. Keep trying! Dennis Richards sends his best to everyone as does Dave Valko. Bill Mayer recently visited the WDR studios in Cologne, FRG. Wish I was with you. Steve Reinstein says that his mailbox is beginning to light up with QSLs. You've got some good ones in this Column, Steve...Sam. Dick Cassidy wants his QSLs to start comming in a bit more often. Jean-Pierre Caravan spent this past September in Cherbourg, France. He took along his RF-2900 and logged several new stations.

**TAIWAN:** Voice of Asia 5980 f/d cd. in 75 ds. (Barrera-ARG).  
**TANGIER:** Radio Mediterranee Internationale 9575 form ltr. in 4 1/2 mo. v/s \* Pierre Casalta, (Berg-MA).

**THAILAND:** Radio Thailand 9655 f/d cd. in 102 ds. for 2 IRCs. (Barrera-ARG).  
**UKRAINIAN SSR:** Radio Moscow 7150 via Lvov f/d cd. in 50 ds. (Erwin-VA). 9765 f/d cd. in 30 ds. (Levison-PA).  
**UNITED ARAB EMIRATES:** UAE Radio Dubai 15300 f/d cd. w/ pennant in 30 ds. v/s K.F. Fennner. (Richards-CT).  
**USA:** WWV 10000 and 5000 f/d cd. in 2 wks. (Erwin-VA).

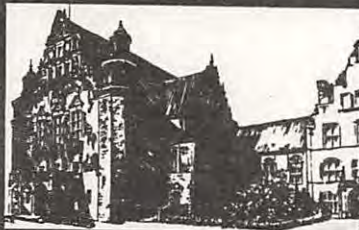

POZNAN The Adam Mickiewicz University

RADIO POLONIA



estoy en la ruta de los 30 años  
**ECOS DEL TORRES...**  
*la predilecta!*



CERTIFICADO CONFIRMANDO ESCUCHA

Sr.  
RICHARD A. D'ANGELO  
2216 Burkay Drive  
WYOMISSING, PA 19610  
USA.

De mi mayor consideración.

Tengo el agrado de dirigirme a Ud., haciendo referencia a su reporte de fecha 20 de septiembre de 1982, mediante el cual confirma los datos de recepción practicados sobre LRA 36 Radio Nacional ARCANGEL SAN GABRIEL.

Sobre el particular, llevo a su conocimiento que los datos aportados en su informe de recepción son correctos ya que concuerdan plenamente con los archivos de programación de esta radiceisora para esa fecha.

Para su información, LRA 36 emite sus programas diariamente entre las 2200 y 0030 horas del Meridiano de GREENWICH, en las frecuencias de 6.030; 11.955 y 15.476 KHz, bandas de 49; 25 y 19 metros respectivamente. En cuanto la potencia se refiere se de aproximadamente 2 KWS.

Agradeciendo su fina atención, hago propicia la oportunidad para reiterarle las expresiones de mi consideración más distinguida y le envío un fuerte apretón de manos desde este lejano Territorio Antártico Argentino.

Base Esperanza, 30 de Octubre 1982.

USA:Voice of Free China 5985  
via WYFR f/d cd. in 60 ds  
(Leivison-PA).

USA(Pirate): KQRP 4960 f/d  
\* cd. in 70 ds. for ms. 150  
watts. (Niekamp-MN). 7415  
f/d cd. in 80 ds. for ms.  
(Renfrew-NY). 15052 cd.  
\* in 3 wks. (Berg-MA). Radio  
VPR 7410 f/d cd. in 10  
\* wks. (Berg-MA). KPRC 6275  
f/d cd. in 80 ds. (Ren-  
\* frew-NY). WIMP 7435 f/d  
cd. in 25 ds. for ms.  
(Rigas-IL). 7430 f/d cd.  
in 1 mo. for SASE. 200  
\* watts. (Erwin-VA). Radio  
Heartland 7427 f/d cd. in  
17 ds. for ms. v/s Chris  
Allen. (Rigas-IL). same in  
12 ds. for ms. (Hart-FL).  
\* Radio Soundwave 7425 f/d  
cd. in 28 ds. for ms.  
(Streeter-NY).

URUGUAY: SODRE 9620 f/d cd.  
in 18 ds. for a SP rpt.  
and 2 IRCs. v/s Eduardo

Artigas, Sub - Directortecnico. (Cones-VA).

UZBEK SSR: Radio Moscow 15540 via Tashkent f/d "Lenin Library" cd. in  
72 ds. (Cones-VA).

VENEZUELA: Radio Mundial 5050 ltr. in 3 wks. for a SP rpt. v/s Domingo  
Javier Isturiz R., Director. (Berg-MA). Radio Nacional 9540 f/d folder  
cd. w/ pennant and sticker for a total of 5 SP rpts. over 16 mo. (Berg-  
MA). YVTO 6100 p/d cd. in 25 ds. for a SP rpt. and ms. v/s Simon Salas  
Salas. (Dillon-DC). Radio Barquisimeto 4990 f/d cd. in 5 wks. for a SP  
rpt. and 1 IRC. (Swaringen-NC).

VANUATU: Radio Vanuatu 7260 f/d "Tam-Tam" cd. in  
16 ds. for 3 IRCs. (Yamron-PA).

YEMEN: Radio Sanaa 9780 f/d ltr. in 123 ds. for  
3 IRCs. (Foxx-VA).

YUGOSLAVIA: Radio Yugoslavia 6100 f/d cd. w/ sti-  
ckers in 240 ds. (Cones-VA).

ZANZIBAR: Radio Tanzania Zanzibar 3339 f/d "Map"  
cd. in 34 ds. for an SASE. v/s T. Abdulla. 20  
kws. power. (Reinstein-FL).

NOTE: This time around we had about 92 countries  
reported to the Column. Some real good ones  
with Zanzibar, Rio Muni and Equatorial Guinea  
leading the way. We had our usual excellent  
selection of Latin stations from Peru, Bolivia  
and Ecuador. Also a few good clandestine and  
Asians thrown in.

Till next time have an excellent DX season  
and best wishes over the Holidays...Sam.

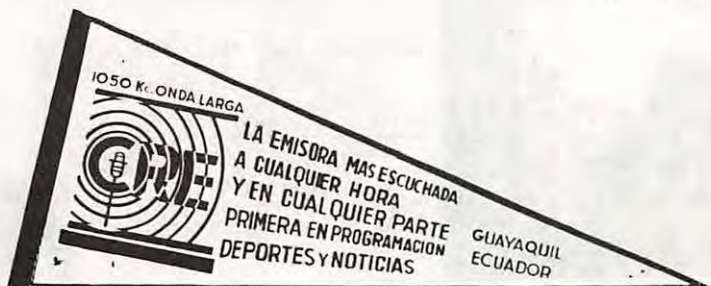



JERRY A. LINEBACK, Editor  
115 WROXTON  
CONROE, TX 77304

DECEMBER 1984

Season's Greetings to all our friends. Welcome to the last Scoreboard for 1984. This month the spotlight is on Europe. Remember that C/H = countries heard and C/V = countries verified. All counts are by the NASWA Radio Countries List and rules. Next deadline is 15 February for the March issue and the Spotlight will be on North America.

Name, state	Total	Europe	Best	Name, state	Total	Europe	Best
	C/H	C/V	C/H C/V QSL		C/H	C/V	C/H C/V QSL
John Tuchscherer, WI	229	41	R. Renascenca	C. Vernon Hyson, NC	187	170	35 35 Andorra
Irving Johnson, CA	226	62	41 8 Lithuania	J. A. Lineback, TX	186	107	35 28 Andorra
Bob Padula, Aust.	223	217	39 37 Andorra	Stephen Leite, MA	185	158	37 36 Minsk
Edward Kusalik, Alb.	220	206	38 38 EMR	John Huniwell, NJ	184	177	37 37 Dublin
Bryan Clark, N.Z.	219	203	39 38 Dublin	Robert Fleck, TX	184	155	36 36 Iceland
Al Sizer, CT	218	218	39 39 Petrozavodsk	John Bryant, OK	182	141	33 32 Iceland
Marlin Field, MI	218	217	39 39 EMR	Mike Hardester, NC	181	166	36 35 K-F SSR
Jerry Berg, MA	218	216	40 39 Tromso	Gordon Blom, NY	181	150	39 39 Andorra
Tom Williamson, Ont.	217	202	40 36 Trieste	Steven Lare, MI	180	133	37 34 RIAS
Bill Sparks, CA	215	211	37 36 Esti R.	Hadley Cress, VA	180	8	33 1 DW Malta
Nobuaki Takahashi, J.	214	179	37 32 Tallin	Del Fye, FL	179	146	37 34 R Esti
Tob Gavaras, MN	213	203	37 35 Dublin	Nelson George, NC	177	140	38 36 Tallinn
Al Miller, OH	211	203	37 37 Andorra	David Swaringen, NC	177	137	
Terry Krueger, FL	210	131	39 31 Condor Int.	Hans Johnson, TX	176	126	
Victor Jaar, Que.	209		39	Walter Kunz, PA	173	95	36 32
Gerald Bishop, PA	208	181	39 38 Dublin	Bob McCoy, VA	170	87	29 28 DW Malta
William Flynn, CA	207	196	38 37 Tallinn	Mark A Duba, VT	169	123	
Larry Abraham, MI	205	190	37 36 Andorra	Ken Cobb, ME	169	121	38 34 S Dublin
Robert Wilkner, FL	205	145	35 30 RFI Scotland	Don Hosmer, MI	167	125	33 31 Dublin
Shalom Gliksman, IL	203	173	39 38 Tallinn	Morley Kirkland, Ont.	165	151	37 34 Andorra
Chris Lobdell, MA	202	199	38 38 R Milano	John R. Tow, AL	165	118	33 32 Denmark
Paul Buer, FL	202	187	40 38 Dublin	Pasquale V. DiBiase, ME	165	111	37 34 R. Time
Dave Valko, PA	202	162	39 25 Condor Int.	Christos Rigas, IL	164	137	36 35 Iceland
Don Moore, PA/Hond.	202	149	39 37 R Nolan	Bob Streeter, NY	162	123	35 28 Westside R.
Brett Saylor, PA	202	119	39 34 Dublin	Michael Schmitz, FRG	161	123	37 33 Austrian Army
John Sgrulleta, NY	201	200	38 38 Andorra	Dan Miller, WI	160	23	32 8 Dublin
Vladimir Cucura, PA	200	107	39 32 EMR	Rick Krzemien, IL	159	121	35 34 Dublin
C. J. Orekar, CA	199	188	36 35 Luxembourg	Tom Laskowski, IN	159	119	33 30 R. Dublin
Mark Koukol, IL	199	174	34 34 S Dublin	Paul Choroszy, ME	158	121	36 35 Yugoslavia
Steve Reinstein, FL	199	154	40 34 RFI Scotland	Larry Cunningham, OH	158	56	33 25 Dublin
Jim Uerlings, OR	196	54	35 23	Norman Bobb, MN	158	1	31
Henry Lazarus, LA	195	192	37 37 Iceland	Dave Maxfield, MI	158		37
Ron Howard, CA	184		34 RIAS	Baxter Hensley, TX	156	141	30 30 Vilnius
Robert J. Vance, FRG	192	174	38 37 Dublin	Gale Van Horn, TX	154	116	
Troy Gower, IL	190	167	33 31 Iceland	Scott Warner, SC	153	120	38 34 Andorra
Henry Ward, Que.	190	166	40 39 Scotland	Jim Fortney, PA	151	88	36 27 S Dublin
Martin Foltz, MI	188	151	37 31 Dublin	David Jones, VA	150	131	
Richard Davis, CO	187	170	34 33 Iceland	Ken Loh, CA	147	109	31 29

Name, State	Total			Best QSL	Name, State	Total			Best QSL		
	C/H	C/V	C/V			C/H	C/V	C/V			
Nolan Stephany, NY	145	127	33	32	Spectrum	89	72	34	34	Dublin	
Austin Kelly, IL	145	118	35	34	Dublin	Ed Dye, AR	88	59			
George Link, CA	143	111			Harold Levison, PA	85	57	29	24		
Peter Tutak, NJ	140	100	32	31	Andorra	Joe Polchlopek, Jap.	85	56	21	16	Monaco
Sheryl Pasklewicz, WI	139	102	32	32	Yugoslavia	Ichiro Maruo, Japan	83	65			
William Plum, NJ	138	104	35	32	Dublin	Frank Wheeler, KS	80	65	25	25	
Robert L. Woods, VA	136	43	35	24	Finland	Rob Sobkoviak, IL	77	57			
John Mosman, IL	132	96	30	30	Iceland	Michael Monaco, NY	77	53	28	21	Vilnius
James Smallwood, FRG	131	106	31	30	Sender Freies	Ronald Purdue, MN	77	43	30	22	RAI Italy
Greg Hart, FL	128	71	33	29	Yugoslavia	Paul R. Coombs, Nfld.	76	47			
Arnold Lausevich, WI	126	93	32	29	Lithuanian	SSR Andrew Wertheimer, MN	76	41	27	23	R. Bremen
J. Gary Pate, MD	123	100	31	25		E. M. Church, VT	70	47	16	9	Greece
Gene Purdum, MI	123	84	32	29	Luxembourg	Tom Mazelrine, WA	66	55	25	23	Italy
Ray Forsgren, WI	116	66	29	22	Lithuania	Ted Gurley, TX	63	35			
Dale Park, HI	115	35	25	12	Sweden	David Fudge, IA	54	43			
John Dillaman, OH	114	90	33	29	Luxembourg	Joe Freeborn, ND	53	43			
Boris Benkovich, EC	114	73	32	24	Luxembourg	Norman Drew, BC	51	32			
Fr. John C. Eckert, PA	114	17	31			Robert Tomko, NJ	48	38	20	18	Netherlands
Bob Gunderson, MN	113	62	33	27	Ireland	Mike Magick, AZ	46	27			
Tom Daly, NY	112	30	32	15	Kiev						
Peter M. Dillon, DC	110	73	31	27	Rodina						
Louis Sica, Jr., NJ	104	35	28	8	Dublin						
Sam Sanchez, CA	104	1	27	1							
Joe Talbot, Alb.	102	82	31	29	Dublin						
Jerry L. Green, TN	102	71	29	29	R. Polonia						
Keiichi Kondo, Japan	100	70									
Joe Kremer, SC	99	48	30	22	Poland						
Peter Giacomelli, NY	96	81	33	31	Vilnius						
Jim Renfrew, NY	96	10	31	5	Luxembourg						
Jean-Pierre Caravan, PA	90	58	31	26	VoGreece						

Thanks to all our contributors. Have a happy holiday season and good DX. We will see you all in Scoreboard next year. Remember the next deadline is 15 February and the Spotlight will be on North America. You must update your totals at least once a year to remain on the NASWA Scoreboard.

73 Jerry *J.A.J.*

NO COLLECT CALLS ON THESE ADS, PLEASE

FOR SALE: ICOM R-70 in excellent condition with SSB filter for best ECSS work. FM module installed. Price of \$525.00 includes shipping. Scott Walker, 125 Conoy Street, Harrisburg, PA 17104. (717) 236-4607.

FOR SALE: Antenna wire, #12 AWG (19 strands of #26 wire). Fifty feet per pound, 1.6 ohms per 1000 feet, clear vinyl sheathed. Also #12 solid wire with PBC insulation. Price 15¢ per foot or \$12.00 per 100 feet. Bill Taylor, Box 132 Wawaset Road, Unionville, PA 19375. Phone (215) 347-2381.

WANTED: Drake R-7A receiver, preferably with Gilfer modifications. Ira Richolson, 1600 South Eads 1030W, Arlington, VA 22202.

FOR SALE: Yaesu FRG-7 in very good condition with manual. Price \$250 Canadian including shipping or best offer. Niel Wolfish, 3900 Yonge Street #706, Toronto, Ontario, Canada M4N 3N6. Phone (416) 489-7307 up to 0300 GMT.

SPECIAL OFFER: Tropical Band Guide 1984. Combines all 1980-1983 NA log reports from 2000-5900 kHz. Only list showing which stations have been heard in NA, at what times, and with a reception rarity rating for NA. Exact frequencies/schedules with variations, check boxes for heard/QSLed/taped, and more. December only - \$2.00 in NA, \$3.00 elsewhere by air mail. George Sherman, Box 2284, Minneapolis, MN 55402.

# update

December 1984\*\*\*Number 174

Tom Alleman  
636 E. 74th Terr.  
Kansas City, MO 64131 USA  
(816) 523-7292 7-10 pm Central

UPCOMING DEADLINES: 10 December (Mid-Dec) 20 December (Jan) 10 January (Mid-Jan)

Reproduction premitted provided credit is given original reporter and NASWA UPDATE. Dates, times and days GMT: freqs kHz.

\*\*\*\*\*

A NOTE TO ALL CONTRIBUTORS: mail service to UD is going through one of its periodic extra-slow spasms. Please allow two or three extra days (over the usual) for your material to reach me. Apologies to all who have tried to get material in just under the wire unsuccessfully. tha.

\*\*\*\*\*

ARGENTINA R. Rivadavia, 4588USB, in SP 2120-2236; fair w/ much QRN. "Deportivo el Mundo" prgm, which consisted of interviews and on-the-spot telephone reports, rather an SP version of "As It Happens." National and world nx by 2 M. IDs: "Transmite LS-5, Radio Rivadavia, desde Buenos Aires, capital de la Republica Argentina, en su frecuencia de 630 kHz...otra noti... tiempo Argentino..." (Frank Orcutt, NY 11-7)

BOLIVIA R. San Jose, 5984.9, in SP 0935-0951 w/ local mx, M anncr and ID 0946. Fairly surprising signal. (Sam Barto, CT 10-17)

CAPE VERDE IS. R. A Voz de Sao Vicente has been noted on 3930 sometimes very clearly, including ID, roughly 2130-2400\*. It is interesting to note that the anthem played at close down is different from the one that the Cape Verde stn on 3885 used to play several years ago. The anthem used by 3885 years ago was the same as that used by Guinea-Bissau...PT lang used throughout. (Victor Jaar, PQ)

CLANDESTINE LV del CID, 6300, with very strong signal and program of popular Cuban mx // 7400 which was jammed but readable using LSB. 0658-0730. (Orcutt, NY 11-11)

EL SALVADOR R. El Salvador (note name change) has been noted on new 9587a on 23 and 24 October between 0000 and 0200. Signal varies but most of the time is stable and strong enough. In SP. (Jaar, PQ)

PERU LV de la Selva; 4825, in SP 1010-1042. Poor w/ much QRN. "La Musica del Peru" prgm, IDs as: "Desde La Voz de la Selva...programas desde Iquitos..." (Orcutt, NY 10-12)+++ R. Vision, 5360, in SP 0325-0357\*, fair w/ some UTE QRN. "Musica Romantica" prgm, popular LAm love ballads, s/off anncmt by M w/ mx similar to El Condor Pasa played on piano. Have tried for s/on during 1000-1100 period but no luck. (Orcutt, NY 11-11)+++ R. El Sol, 5970, in SP 1030-1050 very nice level. Several vocals and IDs. (Barto, CT 10-15) +++ R. Municipal Calca, 6242.7, in SP 0250-0306 w/ vocal selections and an ID 0300. (Barto, CT 10-17)

SAUDI ARABIA (also Portugal and Hungary) First two in EG and Budapest in GM all at same time on 11910, 1705-35, and all quite readable. Portugal is listed for 11915 at this time but I could only find VOA EG to Europe there. (Orcutt, NY 11-4)

SEYCHELLES FEBA noted at 1810 on 9510 probably in listed Amharic. Fair to good signal, noted on 20 and 21 October. Prgm ends around 1832 w/ IS. (Jaar, PQ)

SYRIA After becoming missing on 7365, Damascus heard (again) on 12085 around 1410 on 23 October then on new 7425 after 2000. Usual Arabic prgms. Noted again on the latter frequency on 24 October also. (Jaar, PQ)

TUNISIA Tunis noted lately on new 11730 around 1730 and later, and sometimes as early as 1400. Arabic is used. (Jaar, PQ)

\*\*\*\*\*

An interesting letter from Prince Terry, operator of Westside Radio received here courtesy of friend John Campbell:

IRELAND Westside Radio will be testing on the air for the next few weeks on 11463 in the 25 mb at 1000 GMT Sundays with 40 watts of power. Stn has been on air since 1976 in one form or another, and has been raided at least once. In its present incarnation, it ordinarily operates on 6280 Sundays 1000-1300 GMT, usually with local prgms but occasionally relaying other stns. Correct reports will be QS'ed (a sample was included in the packet sent to me). Address is Westside Radio, c/o 310 Collins Avenue West, Whitehall, Dublin 9, Eire.

\*\*\*\*\*

And again this issue we have reports from friend Juan Carlos Codina in Lima, Peru. These generally cover the month of October 1984:

- 3460.8 PERU Radio La Voz de Oxapampa, Oxapampa, Pasco, first noted with amazing 20 db over 9 signal, though very low audio at 0150 10-21. Cumbias andinas mx when first heard which confirmed that it was indeed a Peruvian. "Saludos musicales" format. Heard several IDs as "Radio La Voz de Oxapampa" 0220 but still difficult to understand why it is using this frequency and why so many modulation problems. Normally on 3260 and since this was heard for several days it might well be their new SW freq. Shortly before closing annced that SW was back on the air after being inactive for some time due to technical problems, confirming both observations as to its absence and the new freq. Mentioned both MW and SW freqs at s/off and opened again the next day at 1108 though with carrier only. Carrier stayed on till 0330 during previous s/off. Hope the modulation improves.
- 3958 MALVINAS/FALKLANDS FIBS USB reduced carrier heard evenings beginning 10-9 w/ W anncr but language seemed to be Nepalese. Are Gurka troops still stationed there? 0130-35, into EG language dj so this seemingly is a British Forces stn with parts in Nepalese. Relatively good signal but QRM from jammers on 3960. Nothing heard on 2380, but perhaps only a propagation problem. On air till 0500 or 0530 and back 0900 but carrier remained on all night. First time heard on this freq during evenings in nearly two years.
- 4096.5 PERU Radio Gran Pajaten, Celendin, first heard as a het to the Brazilian wandering around in the 4094-4097 range. Clear modulation and reasonably good strength, but the Brazilian is dominant here with its Soviet-jammer style of distortion. Mx initially like that of North Peru or Ecuador. Noted 0030 10-13; commercials for Celendin stores, also one for a bus company which said that with that company you at least will arrive at your destination "sano y salvo" (this means plainly, alive)!!!! Program from 0000 to 0100 is entitled "Fiesta Andina". In between cuts, lots of comunicados. At 0050 heard mentioning the address and then the ID: "...en los estudios de Radio Gran Pajaten, Jiron Ayacucho 402..." When last heard, 18 months ago, they were stable on 4460 kHz but now are stable here. This seemed to be first day on the air for Gran Pajaten but had noted carrier previously, possibly testing Heard till 0434\*. By that time the distorted and wandering Brazilian was off the air leaving this space entirely open for this rare stn from Cajamarca. By end of xmsn, Gran Pajaten had slipped up to 4096.6 and sometimes IDed as "Erre Ge Pe" (RGP). Closed with national anthem. Next day heard about 0000 on 4097.8, anncing "los 4200 kilociclos" and "RGP, tu mejor compania." Other Celendin are Radio Moderna, 4300.1, Radio Celendin, 7052.9 and, Radio Nuevo Eden, 6814.6, not heard during the last months.
- 4096.8 UNIDENTIFIED Acre, Brazil??? First heard 10-5 distorting badly at 0018. Later moved to 4097.6. Following day heard on 4097.4 with Brazilian pops, though very distorted. Also noted Brazilian folk mx. Thought Jaen at first but monitoring confirmed as definitely Brazilian. Closed with national anthem but without ID. Other days heard on 4095.7 closing 0130\*a, though carrier remained on until 0200 or later. Opens 1030 but carrier on as early as 0825. Started at 4094.5 and moved up. Soap opera prgm weekdays 1200 (radioteatro) but might also be a children's prgm.
- 4920 PERU Radio Central, Bellavista, Huallaga, San Martin, now here with 25 db over s9 signal, though slightly distorted. Slight het from Radio Quito. The prgm from 2200-2300 is called "Constelacion Iberoamericana" (pops is SP). 10-16.
- 5190.7 PERU R. Nuevo Continente, Cajamarca, reactivated and first heard with 20 db over s9 signal on 10-10 at 0045. Announcing "en calidad de prueba." Pop mx and very good modulation. Lots of IDs. Some of them: "Peeeee-ru...en Cajamarca esta tu ...Nuevo Continente, tu onda corta distante." (This canned with some mx behind.) This was first day on the air after blowing up its tubes over a year ago. Nice to see them back!!! Also heard 10-11 early in the morning but not since then.

\*\*\*\*\*  
 More from Juan Carlos, Richard Wood and Hitoshi Miyashita next time. Until then,

Vy best 73, *MSA*



# LOG REPORT

## section A

2000 to 4899 kHz

Editor: Mike Nikolich, 2137 West Farwell Ave., Chicago, IL 60645

- 1660 BELIZE, R. Belize; 0500-0509\*, SP, this is my UNID station hrd in the Sept. Frendx. Thanks to harmonic Glenn Hauser for helping me ID it (Trotto, FL 10/14)
- 2390 GUATEMALA, LV de Atitlan; 0134, SP, lite classical mx, short OM tx, 0138\* (Trotto 10/30)
- 2490 UNID, 2345-0015, PT, OM and YI tx w/echo in background, sounded like relig. px (Trotto 10/30)
- 2520h VENEZUELA, YVRU/Caracas; US soft rock at 0345, pops, singing IDs as "RU", 0400\*, "RU, YVRU en la frecuencia de 1260 kHz termina sus labores del dia de hoy. En nombre de sus locutores...vos invitamos para las 6 de la manana a amanecer con RU," 2x1260 (Wood, Hawaii 10/10)
- 3200 LIBYA, SPLAJBC; 2211, AR OM w/usual discourse (Bolland, FL 11/3); 0200, AR, chants, little tx (Nikolich 11/21); 0210, drama px w/ID at 0217, "Swat ul-watan IL-Kebir; Sawt lth-Thawrat Ish-Sha'Abiyyah" (Dillon, DC 10/13)
- 3215 INDONESIA, RRI/Menado; 1118, singing until half hour then nx for 10 minutes (Bolland 10/28)
- 3215 VENEZUELA, Ondas Panamericanas; 1020, SAM mx, "...Ondas Panamericanas," TC, 11/7, also 2311 on 11/6 (Bolland)
- 3222 TOGO, R. Kara; \*0530, s/on w/NA, ID, FR tx by OM, some highlife mx, not //5047 (Nikolich, IL 10/26)
- 3230 PERU, R. El Sol de Los Andes; 0952, SP, presumed w/huaynos until KOed by s/on of YV on 3225 (Moore, Honduras 9/26)
- 3230 SOUTH AFRICA, R. RSA; 0300, s/on w/EG nx about S. Africa (Alcorn, NJ 10/14); 0135, western pop mx, "Good Morning Africa" px (Speed Gray, MI 10/15); 0340, feature on SAF aid to Ethiopia (Green 11/4); 0303, YL w/nx (Bobb, MN 10/24)
- 3235 INDIA, AIR/Gauhati; 1625, EG reminiscenes of Jawaharlal Nehru (Wood, Hawaii 10/21)
- 3250 HONDURAS, R. Luz y Vida; 0045, SP, mx, listener letters, really booming in tonite (Dickson 11/8); EG/SP px w/ID at 0410 (Swaringen 10/1)\*\*Both noted stn on 3254, too...mln.
- 3254.6 HONDURAS, R. Luz y Vida; 0235, SP, relig. mx, TC and ID at 0238, then more relig mx (Valko, PA 10/23)
- 3255 LIBERIA, ELBC; 2315, EG, EZL mx, OM ID w/s/off anmts and IDs as "Liberian B.S." 0002\* (D'Angelo, PA 10/5); 2245, US pop, EG host (Pate, MD 10/20); 2324, non-stop jazz, contest anmt "5 dollars per ticket" (Valko 10/7)
- 3260 ECUADOR, LV del Rio Carrizal; 0254, SP, non-stop lite LA mx, TCs and ID as "R. Carrizal" s/off 0330\* (Valko 10/24); 0237, mellow LAM pops, one ID at 0242 (Forsgren, WI 10/25)
- 3260 NIGER, ORTN; \*0530, FR, flute IS, OM w/chants and Afro vocals, no def. ID, so "tent" (Cobb, ME 10/6)
- 3285 BELIZE, RB; 0158, almost swamped by CW stn on 3287, IDs by OM w/accented EG, "This is RB, the Voice of the ... Central American Nation of Belize," some of the ID got lost in noise...I've been waiting years to hear Belize on SW! The CW stn is Canadian Navy/Vancouver. No matter how the band is, the CW stn is S-9+20 or better. The R71A is the first rx I've had that could separate 'em...Its ECSS capability is phenomenal! (Palmer, WA 11/6)\*\*Congrats! 0400, theme from "Chariots of Fire" (Swaringen 10/1); 0430, EG, C&W mx, decent signal (Joe Erwin, VA 10/19); 0059 (Enkenhus, MD 11/2)
- 3295 NAMIBIA, R. SWA; 0330, pop mx, OM w/long periods of mx (Gray 10/15); 1640, full ID w/lite jazz (Park, Hawaii 10/27); 0240, EG, mx px (Dickson 11/3); 0357, ID in EG, "You are listening to the all-night svc of Radio SW Africa"(D'Angelo)

- 3306 ZIMBABWE, ZBC; \*0325, percussion IS, OM in Vern., IDs and choral mx, sermon to 0348, tough under UTE (Atkins, AL 10/28) 0335, lively Afro vocal mx, tx by OM in Vern (Valko 10/12)+1
- 3310t CHINA, Jilin/Changchun; 0900, lite classical mx past 0906, no anmts, CW QRM, heavy QSB (Nikolich, Hawaii 11/15)
- 3310 PERU, R. Bagua; 0246, SP, flute mx and some pop mx, excited OM w/mentions of Peru, Huancabamba and Bagua (Valko 10/1); rough voiced OM w/tx, huaynos (Bolland 10/30)
- 3315 ECUADOR, R. Pastaza; 0246, SP, EZL LA mx, romantic vocals, ID w/freq and address at 0303 (Dickson 10/30)
- 3320 NORTH KOREA, Pyongyang Broadcasting-Stn.; 0910, almost RS-flavored classical mx (Nikolich, Hawaii 11/15)
- 3340 UNID, 1004, SP, non-stop inst. and Andean mx, OM anmts at 1026 (Moore, Honduras 9/26)
- 3355 NEW CALEDONIA, Noumea; 0830, poor lvl w/FR pxs, //11710 (343) and 7170 (454) (Nikolich, Hawaii 11/13)
- 3360 CHINA, Beijing; 1546, Amoy?? Traditional CH songs played by OM DJ (Park, Hawaii 10/27); 1605 (Nikolich, Hawaii 11/12)
- 3360 GUATEMALA, LV de Nahuala; ID at 0143, marimba mx and vocals, OM host (Dickson 10/24);
- 3380 GUATEMALA, R. Chortis; 0105, marimba mx, "Jocotan" mentioned frequently, IDs for "R. Chortis," (Palmer 11/6); 0230, IDs, local mx (Dickson 11/5); 0225, OM w/"Noticias Internacional" IDs (Prath, FL 11/3)
- 3380 MALAWI, MBC; 2155, pop mx, OM in Vern., organ theme to 2209 (Atkins, AL 10/27)
- 3395 ECUADOR, R. Zaracay; 0148, SP, many IDs, mention of freq. and Santo Domingo, TCs, nice HC mx px (Valko 10/1)
- 3396 ZIMBABWE, ZBC; 0435, EG C&W mx, ID (Wood, Hawaii 10/10)
- 3539 UNID CENTRAL AMERICAN; 1104, SP, EZL versions of pop hits, frequent TCs, often over mx, some commercial anmts, including one for India Airline flights to Dubai! YL w/"Esta es nuestro reloj...para todos Centramericanos"(Pappas 10/28)
- 3600 UNID; 0020, SP, US rock mx and SP pops, ID by OM, on "hot-line" since May (Trotto, FL 10/31); this one is driving me nuts! hrd 11/3 and 11/6 1000-1040 (McCurdy 11/6)
- 3900 CHINA, FFS-2; 1505, Amoy Chinese, poor signal, stn carries second px to Taiwan, based in Fujian, //4380 (Palmer 10/25); 1610, clear w/CH mx and OM in CH, //3400 (Nikolich HI 11/12)
- 3910 JAPAN, FEN/Tokyo; 1525, EG, YL w/rock mx, appeal for some sort of donations (Palmer 10/25); 1610, Peter Wolf's "I Need You Tonight," YL DJ, into sports report, //6155, strong (Nikolich, Hawaii 11/12)
- 3925 JAPAN, NSB/Tokyo; vy powerful signal here, //9595, 1530-1545, when can you hear Sapporo? (Palmer 10/25); 1615, very strong lvl //9595 (Nikolich, Hawaii 11/12)
- 3930 SOUTH KOREA, KBS/Seoul; 1600, nx, ID, 6135 was not //(Wood 10/20); 0925, interview px w/2 OMs, very casual atmosphere w/plenty of laughing (Nikolich, Hawaii 11/15)
- 3930 TRANSKEI, Capital Radio; 0359, ID, cigarette ad, nx, pop mx, fair w/ARO QRM (Forth, IL 10/3)
- 3931 CAPE VERDE, Voz de Sao Vicente; 2300-2402\*, fair lvl mixing w/AROs w/US pop mx, s/off w/clear ID, NA and 4 gongs at 2402, then a resumption of highlife mx! (someone left xmtr on...) switched off 15 seconds later (Nikolich, IL 10/24); 2330-2359\* PT tx by OM, ballads, NA and off, no chimes hrd today (Alexander, PA 10/20); 2305, ballads, pops, 4 chimes, ID, nx and guitar IS, 2402\* (Paszkiewicz, WI 10/6); 2315, Laura Branigan song (Pate MD 11/3) \*\*Also noted by Wood at 0750, Valko at 2225 and Bolland at 2311...
- 3945 JAPAN, NSB/Tokyo; 2nd program, lite piano mx, //6115, both in very well (Nikolich, Hawaii 11/15)
- 3957 SOUTH AFRICA, SABC; 0400, EG nx interview, //4835, still in at 0500 (Wood, Hawaii 10/9)
- 3956 PERU, R. Quiruvilla; 1113, SP, nice Peruvian flute mx, have 2 taped IDs, but they're difficult to decipher, noted JCC log in RIB (Sams, AR 9/27); Could not decipher stn name...
- 3958 FALKLAND ISLANDS, FIBS; \*0858, EG, s/on w/march mx, full ID by OM, BBC nx until 0907, into pop mx, TCs and several mentions of Stanley (Valko 10/11); \*0858, identical px to Valko's log (Nikolich, IL 11/10) +3

- 3958 PERU, R. Huamachuco; 1034, lots of Andean vocals, OM (Moore, Honduras 9/26)
- 3960 INDONESIA, RRI/Palu; 1346, Choral mx, IDs at 1347, regular most AMS (Wilkins, CO 10/28)
- 3965 AFGHANISTAN, RM Kabul Relay; 1610, YL tx in RS (Nikolich, Hawaii 11/12)
- 3970 JAPAN, NHK Home Svc; 0755, JP stock market talk (Wood, Hawaii 10/25)
- 3985 TIMOR, RRI/Dili; 0910, IN, Islamic mx, 0913, ID "Inilah RRI Dili. Sdra.-Sdra. penengar, dari RRI Dili..." IN vocals (Wood, Hawaii 10/16)
- 3995 USSR, Kyzyl; 1610, RS tx by OM (Nikolich, Hawaii 11/12)
- 4000 CAMEROON, R. Bafoussam; \*0430, NA, drums, FR ID, best on band (Wood, Hawaii 10/10); 2245, FR, lcl mx, OM w/ID, then IS to 2300 (Forsgren, WI 10/8); 0528, FR/EG, tx ID into EG relg. px (D'Angelo 10/7)
- 4000 INDONESIA, RRI/Kendari; 1510, IN, poor w/IN mx, s/off anmts, OM, "Love Ambon" at 1517 (Palmer 10/25)
- 4040 USSR, Vladivostok listed; 1444, RS, Mayak px, OM, RS pop mx, tango in GG, Moscow time and IS (Sharpe, CA 10/14)
- 4095 UNID, 1040, SP, definitely a Latin here w/bouncy flute mx, guitars, SP OM (Sams, AR 9/27)
- 4120 N. KOREA, V. of the Rev. Party for Reunification of Korea; 1400, EG, IS, NA, long diatribe by YL (Wilkins 10/25)\*\*This stn. was my #1 priority when I went to Hawaii. Didn't hear it so I guess I'll have to wait until mid-January...min.
- 4200 VENEZUELA, Ecos del Torbes; 1050, "Noti-Rumbos" and usual doorbells, 1/4980, so apparently a mixing product at the xmtr site, 4980 minus 780 = 4200 (Reinstein, FL 10/27)
- 4380 CHINA, PLA; 1038, CH, YL vocals (Bolland 11/7)
- 4485 USSR, Petropovlavsk; 0945, RS, musical px (Bolland 10/15)
- 4588 ARGENTINA, R. Rivadavia; 0042, noted in passing per tip from JCC, banco ads, jingles, USB feeder, ex-9115(Reinstein 10/15)
- 4656t ECUADOR, CRE; 0300, SP, LA mx and ballads (Dickson 11/4); 0902, non-stop mx until 0941 (Bobb 10/27); 0330, "...Universidad, Guayquil" (Forsgren 10/25)
- 4719 INDONESIA, RRI/Ujung Pandang; 1240, YL vocals, anmts by YL, strong under usual UTE (Lineback, TX 10/27)
- 4725 BURMA, BBS; 1110, YL tx and mx, very slight signal, better by 1123 (Bolland 10/13)
- 4740 USSR, R. Afghanistan; 0125, lang, flute IS, NA, ID, Koran (Hawk 10/14)
- 4752.9 INDONESIA, RRI/Ujung Pandang; 2150, doing well w/OM IN tx, 2159:30, into Rayuan Pulau Kelapa (Reinstein 11/2); 2200, OM nx, YL at 2208 (Bolland 11/3)
- 4755 BRAZIL, Rdif. Maranhao; 0625, PT, mellow ballads, IDs (Forsgren 10/13)
- 4755 PERU, R. Huanta 2000; 1013, SP, beautiful vocal mx, ID by YL, "5 de la manana con 21 minutos en la studios Radio Huanta 2000," best hrd in a while (Valco 10/8); \*1016, canned ID by YL (Bolland 11/5)
- 4760 LIBERIA, ELWA; \*0555, IS, ID at 0600, nx headlines, relg. mx (Alexander 10/13); 0658, BBCWS nx (O'Brien 10/23)
- 4760 PERU, R. Inca; 0950, hrd various mornings w/ID, call letters, much QRM de Cuba (Field, MI)
- 4765 BRAZIL, R. Rural; 0805, PT, Brazilian pop mx, ads, tx, IDs, this freq in clear due to Cuba dropping down to 4763.4 (Alexander 11/4)
- 4770 VENEZUELA, R. Mundial Bolivar; 03030, SP, contemp. mx, OM DJ w/clear ID (Dillon, DC 10/23); 0120, baseball (Forsgren 10/25); 0140, ads for Bank of Industry & Commerce (Dickson); 0951, rapid fire TCs, slogans (Niekamp 10/30)\*Enjoyed meeting you in Minneapolis, Ray! min.
- 4770 NIGERIA, FRCN/Kaduna; 0502, TC, U.S. mx, ID for "2nd Channel of R. Nigeria..." (McLemore, FL 11/3); 0437, relg. tx and prayer, TC (Daly, NY 10/21); 2040-2200 (Green and Alcorn)
- 4774.5 INDONESIA, RRI/Jakarta; 1052, YL, IN pop mx, ID on the hour (Bolland 11/1)
- 4777 GABON, RTVG/Libreville; 1625, FR tx on "la politique" (Wood 10/11)

- 4780 VENEZUELA, Voz de Carabobo; 0320, ID, lots of LA mx, nice  
lvl (Gray, MI 10/31); 0035, sx event (Daly 11/6)
- 4783 MALI, R. Mali; 0558, FR, cora IS, NA at 0559, ID and opening  
amnts, local Afro mx (Alexander 10/20); 0558 s/on (Forth  
10/27); 0603-0635 (Jordan, PA 11/3); \*0558 (Nikolich, 11/2)
- 4785 BRAZIL, R. Ribamar; 0320, PT, EZL Brazil mx, love songs,  
really strong signal (Dickson 11/5); 0145, EZL mx (Daly)
- 4789.3 INDONESIA, RRI/Fak-Fak; 1211, presumed w/ly weak signal, but  
T/4774.5/Jakarta (Reinstein 11/4); 1117 mx (Bolland 11/5)
- 4790 PAKISTAN, RP; 1630, UR discussin show on Jinnah's founding  
of Pakistan, not 1/5090 or other freqs (Wood, Hawaii 10/11)
- 4790 PERU, R. Atlantida; 0250, SP, ID, tx about economics,  
politics (Lineback 10/20); 1012, OM w/sfx (Cobb, ME 10/13);  
0420, EZL mx, 0458\*, strong (Niekamp, MN 10/18)
- 4795 CAMEROON, R. Douala; 0427, EG/FR IDs, 0431, NA, rooster  
crows, then lcl mx px (Johnson, TX 10/31); 2100 (Pate 11/3)
- 4795 ECUADOR, LV de los Caras; 0345, SP, ID at 0411 in partial EG  
as "HCAC4" (Pate, MD 10/21); 0145, ads, vocals (Dickson 10/23)
- 4815 PAKISTAN, RP; 1615, EG DJ show w/old US rock, "Hello  
Listeners, it's time to open the prgm," 1623, "Now, listen  
to the Eagles..." (Wood 10/23)
- 4815 BURKINA FASO, National Radio of Burkina; \*0530, FR, balafon  
IS, NA and ID, OM, Afro mx (Cobb, ME 10/8); 2317, tent w/tx  
by YL in FR, no ID hrd (Paszkiwicz, WI 10/21); 2308, nx and  
mx (Hawk 10/3); 2341, tx w/mix of Western rock mx and some EG  
lyrics (D'Angelo 10/21)
- 4820 HONDURAS, HRVC; 0415, EG, barely above noise level, even  
w/pre-amp on, SP to 0300, EG after (Palmer 11/5)+Hunt & Cobb
- 4825 GUATEMALA, R. Mam; 0003, just can get ID at s/off, "R. Mam,  
Guatemala" (Dickson 11/4); 2318, OM w/ID (Bobb 11/3)
- 4825 PERU, LV del Selva; 10009, SP, all flute and guitar OA mx,  
IDs and TCs, "Musica Popular" (Valko 10/4)
- 4830 VENEZUELA, R. Tachira; 1045, SP, LA mx, several IDs by OM,  
ads and amnts (Prath 10/20); 0200-0545 (Dickson, McKellar)\*3
- 4835 GUATEMALA, R. Tezultlan; 1124, SP, lively LA instrumentals,  
1130, ID and freqs (D'Angelo 10/27); 0100-0350 (Hunt,  
Niekamp, Palmer, Lineback and others...)
- 4835 SOUTH AFRICA, SABC; 0407, discussion px in EG, ads for  
tobacco products, wx, too (Palmer, Green, Alcorn)
- 4845 BOLIVIA, R. Fides; 0215, SP, EZL mx, 0228, chimes and full  
ID, slogan, "La Voz de Politico(?)" 0302\* (Howard, CA 10/14)
- 4845 BRAZIL, R. Nac./Manaus; 0042, PT, OM, "Boa noite Brasil, boa  
noite Amazonia..." (Palmer 11/6); canned ID by YL (Bolland)
- 4845 INDONESIA, RRI/Ambon; 0855, IN YL, "Dari Ambon," mention of  
Menado (Wood 10/12)
- 4848 BOTSWANA, RB; 0350, EG/Sets, my favorite IS to NA at 0359,  
ID and s/on (Forsgren 10/24)\*\*It really is a great IS...m/n.
- 4853 YEMEN, R. San'a; 2105, OM w/tx, some mx, f/out by 2112  
(Bolland 11/3)
- 4860 INDIA, AIR/Delhi; 1620, EG, 19th-Century story, 1625,  
classical symphony (Wood, Hawaii 10/23)
- 4870 ECUADOR, R. Rio Amazonas; 0235, world nx, accordian and  
flute mx (Dickson 10/27)
- 4875 BRAZIL, R. Nac. do Boa Vista; 0940, PT, pop mx, ID and freqs  
at 0946, R. Super still up on 4876.9 (Alexander 11/4); 0212,  
ZY pop mx, full ID at 0215 (Plum, NJ 10/4)
- 4876p BOLIVIA, La Cruz del Sur; 0959, presumed the one here  
sandwiched between R. Super and Boa Vista w/r/eg mx, 4  
chimes at 1000, no ID (Alexander 11/4); 0955, ID into  
religious tx, gave address (Moore, Honduras 9/21)
- 4885 ANGOLA, ER do Zaire; surprisingly good at 2154 w/tx, some  
mx, Angolan NA to 2200\* (Berg, MA 11/4)
- 4885 COLOMBIA, Ondas del Meta; 0103, ID into mx px, including  
polkas and waltzes (Dickson 10/30)
- 4890 ECUADOR, R. Centinela del Sur; 0135, SP pop ballads, MoR mx,  
spot IDs and amnts (Jordan, PA 10/26)
- 4895 PERU, R. Chanchamayo; \*0950, hrd most mornings opening w/NA,  
then mx and ID, into OA mx px, title of which (on 10/27) was  
"Melodias Andina" (Berg, MA)
- 4895 SARAWAK, RMS; 1432, Malay, YL w/mx px, including "Bungah  
Gelugur", NA and s/off (Sharpe 10/20); 1250 (Lineback 10/27)



# LOG REPORT

## section B

4900 to 6199 kHz

Editor: Jerry Berg, 38 Eastern Avenue, Lexington, MA 02173

- 4900 **VENEZUELA** R. Juventud, rock mx 2339 10-13 (Feeley); good, EZL 0250 10-27 (Hunt); fair 0320 11-5, jazz, temp.wiped out by RTTY 0337 (Palmer-WA); 0356\* 10-25(Swaringen-WC).
- 4904 **CHAD** N'djamena, fair, gal singing 2054 11-3 (Bolland-FL); local mx 2055 11-5(Plotnick); \*0455, balafon IS, NA, FR ID, Afr mx, booming 10-6 (Cobb-ME); Afr mx 0504 10-5, ID at 0515, mx, jammer on same freq, fair overall (Gray-MI); FR nx 0530, better in LSB(O'Brien); 0535 10-12, Afr mx, ID 0540, local vocals, odd instrumentation, more talk (Jordan); tent. them 2055 11-1, mx prgm, talk, NA to 2100\*, fair but noisy (Bobb-MN).
- 4905 **BRAZIL** R. Araguaia, 0243 on 11-1, fair with local mx, full ID 0245, ads (Rigas-IL); mx and talk 0917 10-14, ads, poor signal (Bolland-FL).
- 4905 **CHINA** Beijing, 2240, poor with CH talk, distinctive audio, 11-6 (Bolland-FL); 2240 on 10-30, CH talk; make it tent. cause I fell asleep before supposed 2300\* (Swaringen-WC).
- 4910 **GUINEA** Conakry, 2312-0000\* 10-15, ID 2322, 2358, NA to s/off (Reinstein-FL).
- 4911 **ECUADOR** Em. Gran Colombia, good at 0500 10-10, ID as "En Gran Colombia desde Quito, en la mitad del mundo"; tropical mx (Wood-HI).
- 4911 **PERU** R. Libertad de Trujillo, poor 10-10, folklorica mx 0958, barely above noise(Bolland-FL).
- 4911 **ZAMBIA** Lusaka, poor 0348 10-31, \*0400 with EG ID, mx, bad CW (Gray-MI).
- 4915 **COLOMBIA** Armonias del Caqueta, 1051 10-30, mx, short amts, full ID 1100, weak(Niekamp-FL).
- 4915 **GHANA** Accra, lang ID 2114 11-1, talk, P-F in noise (Bobb-MN); lang talk 2137, MN). two men, fair 11-3 (Bolland-FL); EG nx 2150 10-16, ID 2153 as GBC, into tribal mx, vernac amts 2200; fair (D'Angelo-PA); vernac to 2205\* 11-4 (Green).
- 4915 **KENYA** Nairobi, ID 0335 10-17, "Hii ni Idhaa ya Kiewahili ya Sauti ya Kenya" (Wood-HI).
- 4920 **AUSTRALIA** ABC-Erisbane, end of nx 0910 10-14, sports, ID, cmtry, poor (D'Angelo-PA); 30's mx 0922 10-13, ID 1000, TC, nx (Dillon-DC); mx, amts, 1210 10-27, fair signal (Lineback-TX); 1308 10-28, fair with swing mx, nx with "Wild Bill Davis" (Gray-MI).
- 4920 **ECUADOR** R. Quito, sports 0300 10-28, couple IDs in the hollering; also 11-4 0400 with big band LA mx (Dickson); 0343 10-20, mx, ads, slight het (Niekamp-MN); fair 0345 11-6, LA mx, ID for "la voz de la capital," promo for Banco Popular, cha-cha (Palmer-WA).
- 4926 **EQUATORIAL GUINEA** Bata, two men talking 2117 11-3, Afr hiife mx, fair (Bolland-FL); SP nx 2125 10-20, ID 2130 (Pate-MD); 2138 10-26, talk, lite mx, ID 2158, NA 2200, 2204\* (D'Angelo-PA); NA, s/off, 2200 11-4 (Green); Afr mx, talk, ID, long NA, to 2245\* 10-12 (Bobb-MN); 0510 10-9 SP evocation of "Todos los pueblos de Africa," Afr mx, now here daily (Wood-HI); local mx 0526 10-31, vernac ID 0530, more mx (Johnson-TX).
- 4930 **HAITI** 4VH, 0008 11-6, vy good lvl, clear, FR talk on college, some EG 0020, a little mx, FR ID 0030; pretty early (Palmer-WA); FR talk 0020 10-28, good (Lineback-TX); lite mx 0037 10-20, long pause, amnt, F-G (Niekamp-MN); FR native mx 0850 10-9, ID 0900, address, fair in noise (McKellar-CA); weak, talk, 1250 10-27, I think FR (Lineback-TX).
- 4935 **PERU** R. Tropical, 0953 10-26, mx, man with amts, ads, poor sig (Bolland-FL).
- 4940 **ANGOLA** Tent. ER de Malanje, 0430-0600 fade 11-3, clas.mx, maybe nx by man 0515, recurring mx theme almost identical to Bengula-5044 IS, sig similar; couldn't get ID (Atkins-AL).
- 4940 **USSR** Yakutsk listed, clas.mx 1455 11-3, tent.ID, pips 1500, nx, //4800,4920,5015(Park-HI).
- 4945 **COLOMBIA** Caracol Neiva, pop LA mx 0710 10-20, gangbusters signal (Erwin-VA).
- 4950 **PAKISTAN** Islamabad, Dari nx to afgh 1615 10-17, fair, jammed maybe by Mayak (Wood-HI).
- 4950 **PERU** R. Madre de Dios, weak to 0230\* 10-15, full ID 0225, then NA (Howard-CA).
- 4950 **SARAWAK** Kuching, EG 1134 11-5, //7160, poor; CH at 1200 (Bolland-FL); CH talk 1255 10-27, exc (Lineback-TX); EG nx 1415 10-23, pops (Sharpe-CA); EG 1550-1600\* 10-20, slow NA by military band, gave this freq, also 819 MW; good sig (Wood-HI).
- 4951 **SENEGAL** Dakar, fair at 2155 on 11-3, local mx, some talk (Daly-NY).
- 4958 **AZERBAIJAN SSR** Baku (seems correct propagationally), RS talk 0330 11-4, gud (Wood-HI).
- 4960 **ECUADOR** R. Federacion, ID 0001 10-15, poor (Bolland-FL); SP and Quechua mx 2345 10-1, religious prgm 0000-0045, then SP version of "House of the Rising Sun" (Plum-NJ).
- 4965 **BRAZIL** R. Poti, organ mx, canned s/off amnt, a little mx, 0256\* 10-3, fairly gud (Valko).
- 4970 **IRAN** Tehran, AR ID 1630 10-11, good but usually jammed, Koran recitation (Wood-HI).
- 4970 **SABAH** Kota Kinabalu, EG ID 1300 10-27, into Malay (Lineback-TX); poor 10-29, YL talk to 1430, 6 pips, ID as Kuala Lumpur so apparently a relay (Wilkins-CO).
- 4975 **COLOMBIA** Ondas del Ortegaza, "Amanecer Campesino" prgm 0955 10-3, ID 1030, ads(Plum-NJ).
- 4980 **VENEZUELA** Ecos del Torbes, ID, freq 0131 10-14, good sig (D'Angelo-PA); VOA nx 0158 10-12, full ID, mx romantica (Wilkins-CO); lively mx 0200 10-14, scores, VG (Dickson).
- 4985 **BRAZIL** R. Brasil Central, big production ID 0700 10-13, rooster crows, Braso-pops (Foregren-WI); 0720 10-20, pop mx, ads, ID 0800 (Erwin-VA).
- 4990 **ECUADOR** R. Baha'i, IS, test amnt, 0425 10-28 (Lineback-TX); test to 0500 10-1(Swaringen-NC).
- 4990 **NIGERIA** Lagos, Koran, prayer, ID, NA, 2307\* 10-12 (Bobb-MN).

- 4990 PERU R. Ancash, 0802\* 1-21, BG 1030 (Valko); ID 0941 10-21, YV blocked 0946(Johnson-  
 4990 S. AFRICA RSA, exc 0354 11-3, EG nx 0400, very strong (Palmer-WA). TX.)  
 4990 VENEZUELA R. Barquisimeto, LA mx, US tunes, echo-type ID, 0250 on 10-28 (Hunt).  
 4994 KONGOLIA Ulan Bator, talk 0855, good 10-12, time sig 090; //7259; nx (Wood-HI).  
 4996 PERU R. Andina, to 0503\* 10-19, anmts but no NA (Niekamp-MN); male anncr 0938 10-30,  
 fair in CW (O'Brien); anmts 0939 10-17, huayno 0945, more anmts; fair (Bolland-FL).  
 5005 BOLIVIA R. Cristal, clas.mx 0240-0300\* 10-26, YL at s/off, good sig (Atkins-AL); on  
 10-16, 0215-0300\*, clas.mx, tent. ID 0258 (Howard-CA).  
 5005 EQUATORIAL GUINEA Bata, mx 2310 10-15, ID 2330, sig got noisy, poor overall(Bolland-FL).  
 5005 SARAWAK Sibiu, talk by man in lang, 1305 on 10-27, fair sig (Lineback-TX).  
 5010 CAMEROUN Garoua, EG nx to 2115 11-5, into FR (Plotnick); tribal mx 2145 10-15, IS, nx  
 to 2205 (Forsgren-WI); NA to 2224\* 10-10 (Bolland-FL); \*0427 10-13 (D'Angelo-PA); relig.  
 mx, 0432 10-21, good (Daly-NY); tent. them, AR-type prgmng 0435 11-3 (Palmer-WA).  
 5015 CLAND R. Truth, cmtry on family authority 0404 10-27, mx 0410, two IDs, then some  
 Neil Diamond "They're Coming to America" (Johnson-TX).  
 5015 PERU R. Moyobamba, weak 0415 11-6, mx, Moyo mentions, ads, deteriorating (Palmer-WA).  
 5020 ALBANIA Gjirokastrer (anyone know for sure?), gypsy mx 0415 10-29 (Swaringen-NC);  
 Tirana ID 0430 10-10, Albanian mx, //5057, fair signal (Wood-HI).  
 5020 NIGER Niamey, gal with anmts in lang 2240 11-3, mx, poor signal (Bolland-FL).  
 5020 SOLOMON IS. Honiara, election nx 1057 10-27, pops, "R. Happy Isles" ID (Forsgren-WI);  
 pops 1118 10-27 (O'Brien); Top 40 1235 10-5, nx roundup 1300, then s/off (Gray-MI).  
 5025 BEININ Parakou, EG nx abt IRA bombing 2055 10-13, NA and s/off, fair signal; also at  
 0421 10-21, FR man with nx, poor signal (Daly-NY).  
 5025 PERU R. Quillabamba, M&W with nx 0135 10-27, ID 0156 (Field-MI); slow talking YL 0201  
 10-26, vocal, later TCs, ID (Johnson-TX); to 0259\* with "Tonight We Love"(Alexander-PA).  
 5026UGANDA Kampala, rock mx 0301 10-27, TC, some hilife, PSAs (D'Angelo-PA); Afr mx 0310  
 10-13, ID, EG nx 0400, fgy drifting downward (Alexander-PA); 5033, vocals, ID 0330  
 10-31, TC, nx (Forsgren-WI); 5029, vernac 0338 10-24, a play, EG nx 0400 (Valko);  
 EG nx 0408 10-7, ID, into vernac drama, EG talk, some hilife; fair (D'Angelo-PA).  
 5030 SARAWAK Kuching, talk by gal in lang, 1310 on 10-27, good signal (Lineback-TX).  
 5035 BRAZIL R. Aparecida, pops, reverb ID, I think 0300\* as gone at 0303 checkypoor(Valko).  
 5035 CENT. AFR. REP. Bangui, short NA 0429 10-21, s/on, full ID, nx, poor sig (Daly-NY).  
 5035 KAZAKH SSR Alma Ata, Kazakh ID 1558\* 10-24, prgm prvw, repub.NA; good (Wood-HI).  
 5039 SUDAN Tent. Omdurman, 0413-0445 fade 10-24, Koran to 0417, brief talk with possible ID  
 by man, AR mx, talk (possible nx) 0430; weak under big carrier (Atkins-AL).  
 5040 COLOMBIA R. Cincio, 1025 11-4 (Alexander-PA); 0140 10-27, mx, ads, vy weak (Niekamp-MN).  
 5040 ECUADOR LV del Upano, mx 2332 10-19, ID 2353, disco, ID 0030, NA, 0035\* (Daly-NY).  
 5042.5-5044 ANGOLA ER de Benguela hrd by several. \*0357 11-3, 8-note IS on elec.piano or  
 synthesizer, PT ID 0359, NA, orch.mx, nx 0410, local mx, PT ballads, VG lvl (Atkins-  
 AL); hilife, other mx, 0443 10-14, no ID, faded quickly (Valko); mostly mx, couple of  
 talk breaks, 0443, no ID, fading fast by 0515 (Johnson-TC, 10-31); hilife mx 0447-0459,  
 chimes, ID, nx, more mx 0504, fair 11-4 (Bolland-FL); opening 0515 10-11, "Este e o  
 emissor regional da RKA em Benguela, em onda curta, 4960 kHz (1), a trabalhar continua-  
 mente ate as 24 horas." US standards, soul and African vocals; good sig (Wood-HI).  
 5045 BRAZIL R. Cultura do Para, pops, IDs, 0725 10-13 (Forsgren-WI); 0735 10-20 (Irwin-VA);  
 full ID noted 0829 on 10-8, mx vocals, many mentions of Para; fair-good (Cassidy).  
 5046 INDONESIA RRI-Jogjakarta, 1238 11-5, just trace of sig but big carrier (Bolland-FL);  
 western-style pops 10-27 1648, tent. ID 1659, IS, pips, RRI nx (Park-HI).  
 5047 TOGO Lome, pops 2346 11-2, FR, EG songs, s/off anmts, NA, 0003\*; fair (D'Angelo-PA);  
 good 2349 11-5, het, guitar mx, weak modulation, no ID but surely then; 0004\*(Palmer-  
 WA); IS 0527 on 10-15, NA, choral voices, man anncr; seeded AR (O'Brien).  
 5055 COSTA RICA TIFC, EG relig.prgm 0300 10-31, feature on UK postal svc (Alcorn-NJ).  
 5050 COLOMBIA LV de Yopal, ID 1057 under Ecuador, 11-7, poor (Bolland-FL); fairly good  
 0006 10-15, ID, "desde Yopal . . . LV de Yopal, HJ02, 1350 kHz o.l., HJPV, 5050 kHz o.c.,  
 somos Yopal, somos TOBELAR"; into Bob Dylan (Reinstein-FL); ID, NA, 0101\* 10-26(Field-MI).  
 5050 ECUADOR R. Jesus del Gran Poder, 0949 10-16, IS, bells, ID, HC NA, fair (Bobb-MI);  
 relig.mx, sermon, 1023 10-13 (Feeley); relig. talk, mx, 2305 10-13, ID, fgy, TC 0000,  
 gone by 0105 (Daly-NY); ID 0044 10-14, mx, choir, organ, nice mx, good sig (Dickson).  
 5050 TANZANIA Dar es Salaam, Swahili talk 0303 10-30, hilife mx, ID, weak (Forsgren-WI).  
 5055 COSTA RICA TIFC, EG religious prgmng 0300-0400\* (Parks, D'Angelo-PA, Woods, Gray-MI,  
 5055 ECUADOR R. Catolica Nacional, polka mx 2255 10-13, ID 2302, fair sig but Cassidy).  
 covered by QRN at 2335 (Daly-NY); mx 0121 11-1, relig.svc 0140, ID 0205, haven't hrd in  
 yrs (Field-MI); ID 0139, grammar lesson, fair w/TIFC QRN 11-2 (Wilkins-CO); 0210-0224\*  
 10-14, rel.talk, ballads, ID, HC NA; also hrd s/off 0214, 0315 other days (Alexander-PA);  
 hrd 10-10 0224-0242\*, LA mx, IDs, TCs ment.880 MW, NA at s/off (Valko); M&W talking  
 0230 11-2, IDs, organ mx, NA to 0308\* (Jordan), 10 kw per veri (JB).  
 5055 FRENCH GUIANA Cayenne, \*0900 10-27, IS, LN, opening anmts, world nx briefly, into  
 mellow pops, FR and EG; P-F (Forsgren-WI); ID 0902 10-12, "Bonjour, ici la Rdif. . .  
 nous emettons en onde moyenne et onde courte. Nous vous rappelons notre numero de  
 telephone . . ." Good sig; not Guyana! (Wood-HI).  
 5055 SWAZILAND TWR, bell-chime IS 0356 11-3 after TIFC s/off, EG ID 0358, then s/on in  
 German to S.Africa and Namibia; poor signal (Daly-NY).

- 5066 ZAIHE R. Candip, 0350 10-28, hilife, FR ID 0354, startling scream 0405; fair w/RTTY (Atkins-AL); 0359 10-11, hilife, ID 0400, baby screaming till 0401, talk (Pappas-FL).
- 5094v FAYISTAN Islamabad, 1410 10-29; ID G103 10-30, P-F; 0142 11-3 //4879 (Howard-CA).
- 5095 COLOMBIA R. Sutatenza, nx, LA mx, 0000-0300 (Dickson, Forsgren-WI, Hunt).
- 5192 PERU R. Nuevo Continente, 1022 10-11, many IDs, TCs, F-G, CA mx; a surprise (Valko).
- 5199 CLAND VoNat'l Army Kampuchea? 1100-1115 10-11, Asian prgmg, SEA mx (Valko).
- 5274 PERU R. San Juan de Chota, mx, amnts, 0005-0016 11-4, poor, come CW QRM (Bolland-FL).
- 5289 CHAD R. Moundou presumed, tribal mx 0516, some FR amnts, fair sig 10-28 (Atkins-AL).
- 5333v ANGOLA R. Nacional, ID 2359 11-3, little nx, more mx; fair (Bolland-FL); mixed mx 0336 10-30 (Forsgren-WI); Afr mx 0530 10-11, ID as 2d prgm, muffled modul; good (Wood-HI).
- 5360 PERU R. Vision, mx 1104, nx 1113 10-31 (Bolland-FL); presumed, CA NA to 0358\* 10-13 (Alexander-IA).
- 5444 PERU R. Imagen, IDs 1027, TCs, campo mx; surprised here (Valko).
- 5451 INDONESIA RRI-Biak, 1243 11-5, mx, amnts by man, very poor signal (Bolland-FL).
- 5475 GUINEA BISSAU RN, \*0555 10-30, drum IS, ID, NA, into native singing (Valko).
- 5580 CLAND R. 15 de Septiembre, 1155 10-13, sirens, IDs, talk, //6215 (stronger) (Rigas-IL); sirens 0332 10-20, anti-Comm talk; poor, as were 5555, 6215; 7050 completely jammed (Daly-NY); 0333 10-14 in USE, machine guns, sound effects, //7050 (Jones).
- 5895 BELGIUM BRT, IDs in sev.langs 2135 10-28, Afr drums, into talk (Alcorn-NJ).
- 5900 CHINA PLA stn, local CH mx 1130 10-28, talk by gal, //5265 (Prath-FL).
- 5910 BELGIUM BRT, in EG arnd 0030, mx, ltrs (Levison-PA); "Tx Box" 0030 10-8, "R. World" (Dillon-DC); 0055 10-1 "DX Panorama" (Swaringen-NC); mx 0110 10-13, 0113\* (Daly-NY).
- 5930 CZECHOSLAVAKIA Prague, SP 0400 10-29, noticias, mx (Swaringen-NC).
- 5943 UNID. Asian 1055+ 10-6, 6 pips on the hour, then nx (Sams).
- 5945 AUSTRIA Vienna, mailbag 2145 11-4 (Green); in GM 0300 10-29, pops, GM talk, EG ID 0330 (Swaringen-NC); "Ltr frm Austr" 0430 10-1 (Swaringen); breadmaking 0445 10-24 (Wood-HI); in Esperanto 0553-0557\* 10-7, fair sig (Pappas-FL).
- 5945 UZBEK SSR R. Tashkent, F-G 1410-1500\* EG 10-24, Hindi 1430, //5985 (Palmer-WA).
- 5950 CHINA Harbin, CH clas.mx 1429 10-25, vocals, nice strings; to 1500 (Sharpe-CA).
- 5955 COLOMBIA LV de los Centauros, fair 0408-0500\* 10-24, LA pops, IDs, promos, NA at s/off (Palmer-WA); NA at 0910 10-13, s/on annt, ID 0913, Caracol mentions, HJ mx (Alexander-PA).
- 5955 SWAZILAND TWR, 0355 10-1, IS, ID, instr.mx, GM talk (McKellar-CA); \*0355 10-27, bells, EG IDs, GM ID 0400, into GM religious prgm, fair signal (D'Angelo-PA).
- 5960 CANADA RCI, 0100 ID, nx (Dillon-DC), 0210-0230 with "SWL Digest" (Parks, Swaringen-NC).
- 5965 BRAZIL R. Guaiba, 0320-0404\* 10-24, good to very good, can't r.c.l. ever hearing this one this well; Bras-pops, prgm "Musica Guaiba," pips every 15 mins (Palmer-WA).
- 5965 CANADA BBC via Sackville, pops 1240 10-13, sports, anniv congrats (Alcorn-NJ).
- 5970 PERU R. El Sol, M&W talking 1050 10-30, ID 1100, poor sig (Bolland-FL).
- 5970 S. YEMEN Aden, AR nx 0335 11-4, //6005; good, used only local mornings (Wood-HI).
- 5975 COLOMBIA R. Macarena, surprisingly good 0455 11-5, KGEI-5980 QRM; rhythms, IDs, promos (Palmer-WA); lively HJ vocals 1013 10-13, IDs, F-G (Forsgren-WI); 1041 10-13 (Feeley).
- 5975 ENGLAND BBC, Beatles at 0330 10-29, oldies (Swaringen-NC).
- 5975 S. KOREA Seoul, EG sports nx, 1635 10-15, good signal (Wood-HI).
- 5980 ECUADOR HCJE NF, EG 0747-0800 11-2, "Passport," ID, good signal (Trotto-FL).
- 5980 S. AFRICA RSA, Top 40 0435 10-1 (Swaringen-NC); in Lozi 1534, pops (Park-HI).
- 5982 MEXICO XEUJ, jingles, ID by child 2203 1105 (Bolland-FL); finally made it to Mans. on 11-13, hrd 1102 in progress, many IDs, address ancd, Mex mx; also 11-14 \*1100 (JB).
- 5985 BOLIVIA R. San Jose, F-G 0921 non-stop local mx, ID 0945, more mx; started slipping 1010, but still seems like 5 kw (Valko); 2.5 kw, per veri (JB); 10-13, Andean mx, ID at 0946, Nos. stn QRM 1000 (Alexander-PA); flutes, yelling 0940 10-23, ID 0955 (Field-MI); good with variety of mx 0949 10-23, ID 0958; per QSL, began SW bcstng 8-17 (Reinstatein-FL).
- 5985 USA VoFC over WYFR, seeking taped rpts 0155 10-11, EG (Hunt); 0241 10-29 (Levison-PA).
- 5990 ETHIOPIA Voice of Revol Ethiopia, 0330 11-4 with Amharic nx, good signal (Wood-HI).
- 5990 ITALY RAI, EG intended for Japan, 2200-2230, but good (Bolland-FL, Trotto-FL, Prath-FL).
- 5992 EL SALVADOR R. El Salvador, SP pops 1103 10-27, man DJ, good with het (Pappas-FL); mx 1107 10-30, TCs, urging unity; strong (Niekamp-MX); now pretty regular (JB).
- 5995 AUSTRALIA RA, EG talk on circuses 1137 10-29, AUSIFEX contest results (Park-HI).
- 5995 MALI Bamako, local Afr mx 2150 11-3, nx 2230, pops to 2305, ID, local mx till NA and 0000\*; fair sig with occasional woodpecker; also good //7285, some ARO QRM there (Daly-NY).
- 6000 BRAZIL R. Inconfidencia, PT pop mx 0742 10-27, ID 0745, amnts (Alexander-PA).
- 6005 ASCENSION IS. BBC WS, "Newsdesk" 0420 11-2, UX nx (Park-HI).
- 6006 OSTA RICA R. Relej, SF TCs 0610 10-10, ad for "su casa en San Jose," good sig (Wood-HI); ID 0847 10-8, mx, "melodias inmortales," TCs, ID 0501, nx, good signal (Cassidy).
- 6010 ENGLAND BBC WS, "Jazz for the Asking" at 0650 11-4 (Park-HI).
- 6010 SINGAPORE BBC relay, EG lesson 1645-1700\* 10-11, ex-6165; good sig (Wood-HI).
- 6010 S. AFRICA RSA, IS 0157 10-17, "Afr Today," //5960, 9615 (Gray-MI); world nx 0200 10-11 (Hunt); "Touring RSA" 0230 11-4, "DX Corner" (Park-HI).
- 6015 NICARAGUA LV de Nicaragua, EG 0110 ("nx exactly as it happened") 11-6 (Dickson); revol. EG nx 0148 10-11, nx abt US plans against Nic (Purdue); strong, clear 0151 10-20, into SP 0200, VOA QRM then (Niekamp-MX); many SP IDs, IS 0300 10-25, VG sig (Swaringen-NC); SP election returns 0345 11-4 (Green); very strong 0406 10-13, EG nx (Feeley).
- 6015 VATICAN VR, 0050-0110 10-1 in EG, "Sunday Edition," "Praying With the Pope" (Parks).
- 6020 BRAZIL R. Universo, good with PT ID at 0710 on 10-11 (Wood-HI).

- 6025 BOLIVIA R. Illimani, talk, flute mx, 0925 10-13 (Forsgren-WI); 1000 10-23 (Bobb-MN).
- 6025 HUNGARY Budapest, EG cmtry 2000 11-4 (Green), 0200 (junt, 11-3, Levison-PA, 10-13).
- 6025 MALAYSIA KL in CH 1407 10-24, CH pops, nx 1415, ID 1430 (Sharpe-CA).
- 6030 PHILIPPINES VOA, correspondents rpts in Korean 1340 10-21, //9725, 11945 (Park-HI).
- 6035 AUSTRALIA RA, sports 2142, mx, fair to 2153\* 10-14 (Trotto-FL); 2034 10-12 (Pappas-FL).
- 6035 BRAZIL R. Globo, PT talks 0905, ads, jingles, ID 0908, jingle ID, 10-20 (Alexander-PA).
- 6035 COLOMBIA LV del Guaviare, NA 0938 10-13, ID, HJ mx (Alexander-PA); HJ pops at 1049 10-27, ads (incl. motorcycle repair shop), ID, TC, male DJ; good sig (Pappas-FL).
- 6035 USSR Mayak 2 prgm 1520 10-25, RM IS, TC 1600, nx, pop mx, RS mx (Sharpe-CA).
- 6040 ANTIGUA Dw relay, EG 0100-0150, good sigs (Dillon-DC, Niekamp-MN).
- 6045 INDONESIA RRI-Jakarta, IN vocals 1427 10-30, SCI 1459, 6 pips, I think nx (Wilkins-CO).
- 6050 ECUADOR HCJB, HC flute mx 0929 10-8, ID, relig. mx, in Quechua, FRC Q (Bobb-MN).
- 6050 NIGERIA Ibadan, EG 0556 11-4, Afr mx, ID, nx 0600, vy weak, BBC GM (Alexander-PA).
- 6055 PERU R. Continental here some AMs after 1000, few IDs, non-CA sounding (JE).
- 6060 PORTUGAL Lisbon, \*0300 11-1 in EG, into nx (Green).
- 6065 CANADA CBC Northern Svc, EG 1110 10-17, world nx, into local language; good (Trotto-FL).
- 6065 SPAIN REE, \*2300 10-14, gud in SP (Trotto-FL); 0525 11-3 in EG, mx, talk (Jordan).
- 6070 BRAZIL Maybe R. Itatiaia, mx 0834 10-20 but blocked by HCJB s/on at 0840 (Field-MI).
- 6070 LIBERIA ELWA, EG BEC WS relay of nx 1700 10-10, local nx 1709, relig. prgm (Wood-HI).
- 6070 PORTUGAL Lisbon, PT futebol at 0220 on 10-24, good signal (Wood-HI).
- 6075 HONDURAS LV del Junco, ads 0052 11-1, soon unreadable (Wilkins-CO); clear ID 0129, ads, promos, mx (Niekamp-MN); drama 0147 10-20, ads, IDs (Forsgren-WI); vy strong 0206 10-20, drama to 0315, ads, ID, EZL mx (Howard-CA); good 0305, talk, mx 10-21 (Fate-PORTUGAL Lisbon, mx and many IDs, good signal at 0400-0415 on 10-25 (Swaringen-ND).
- 6080 CANADA CFXP-Vancouver, 0804 after VOA s/off, C&W, wx, sports, long fades (Atkins-AL).
- 6085 FRG Bayerischer Rundfunk, pops to 0630 10-14, gospel mx, poor and QRM'd (Pappas-FL).
- 6089 NIGERIA Kaduna, native mx 2241 10-22, talk, NA to 2300\*; het from 6090 (Valko).
- 6090 CUBA Havana hrd here in EG 0200-0300 (Dickson, Jordan, Swaringen-NC).
- 6090 GUATEMALA TGMU, rel. mx 1057, 1100 s/on 11-4 (Alexander-PA); EG armts arnd 1130 (JB).
- 6090 LUXEMBOURG R. Luxembourg, GM ID 0700 11-6 (Wood-HI); GM ID 0811, pops (Trotto-FL).
- 6095 POLAND Warsaw, 0415 with Polish talk on military, good sig 10-10, //9525 (Wood-HI).
- 6105 MEXICO Su Pantera, 0510\* 10-13, "Star Wars" theme, off with NA; fair (Pappas-FL).
- 6106 BOLIVIA R. Panamericana, 1029 (Bobb-MN), 0210 (Johnson-TX), 0330 (Forsgren-WI).
- 6110 MALTA R. Mediterran, EG nx and mx, good signal 2232 on 10-13 (Paskiewicz).
- 6110 PHILIPPINES VOA, 1750 11-4 "Talk to America" w/Larry King, to 1800\* (Park-HI).
- 6115 GDR RBI, IS at \*1615, into FG for Europe, fair signal (Wood-HI).
- 6115 MEXICO XEUDS, instr. mx 1620 10-24, many IDs; hrd past 1900 (Wilkins-CO).
- 6115 PERU R. Union, ads for "Viebles Herrera en La Victoria" 0210 10-24 (Wood-HI); CA mx 0521 10-18, ads, TCs, promos (Niekamp-MN); IDs, TCs, like Llano, 0835 10-13 (Forsgren-WI); exc 0949 10-24 (Reinstein-FL); vocals 1118 10-26, TCs, IDs (Johnson-TX).
- 6117 COLOMBIA LV del Llano, LA mx, man with ID 0420 10-28 (Hunt); ID 0524 10-21 (Sharpe-CA); LA mx 0615 10-27, fair in GRM (McKellar-CA).
- 6120 MICARAGUA R. Zinica, NA 0506, ID, fgy amnt, 0508\*, 10-23 (Niekamp-MN).
- 6120 PHILIPPINES FEBC, 1401 10-22, IS, ID 1405, CH nx; listed as 10 kw (Park-HI).
- 6125 GDR RBI, \*0000 with IS, SP ID by man anncr, then talk by gal; good signal 11-5 (Trotto-FL).
- 6135 BRAZIL Tent. R. Gaucha, M&W talking 0907 11-3, mx, maybe ID, fair in QRM (Bobb-MN).
- 6135 POLAND Warsaw, classical mx 2145 10-28, ID, talk by M&W, //7270 (Prath-FL).
- 6135 TAHITI Papeete, FR pop mx 0655, talk by M&W, island mx, 0730\*, //9749, 11826 (Alexander-PA).
- 6139 BOLIVIA R. Santa Cruz, 0920-1000 10-26, nice CP mx, clear IDs (Reinstein-FL).
- 6140 ECUADOR HCJB, NF in EG 0230-0300 (Trotto-FL, McLemore-FL).
- 6140 NIGERIA Seems a Nigerian here 0555-0610 10-21, Afr mx, TC, ID, nx; who? (Valko).
- 6140 PERU R. Huayllay, 0925-0943, local mx, s/on armts 0930, ID 0940; just slightly lower than Australia-6140 which makes a tough het; wiped out 0943 by someone's carrier (Valko).
- 6140 USA AFRTS, nx 1120 10-17, talk with author, TC, wx, fair sig (Trotto-FL).
- 6145 INDIA AIR, carrier 1421 11-1, IS 1428, pips 1430, ID, local nx, mx (Howard-CA).
- 6150 COSTA RICA R. Impacto, election nx 0045, "Banco Central" ad, nx, booming signal 10-20 (Niekamp-MN); romantic songs 0210 10-19, ID 0212, ad, good sig (Daly-NY); SF mx 0230 on 10-29, "Musica Impacto" mentioned 0239 (Swaringen).
- 6155 AUSTRIA Vienna in GM at 0510 10-28, industrial nx, good sig, //9545 (Wood-HI).
- 6155 JAPAN FEI-Tokyo, 0835-0900 10-21, gal, pops, full ID 0900, into nx (Sharpe-CA).
- 6155 SINGAPORE Singapore, lang 1103 11-1, gal talking between pops; poor signal (Bolland-FL).
- 6160 NEWFOUNDLAND CKZN-St. Johns, interview abt museum funds, 1054 10-13 (Paskiewicz).
- 6165 ITALY RAI, IS 0350 11-4, Italian ID, Italian nx; fair, RM GRM (Trotto-FL).
- 6170 FRENCH GUIANA Cayenne, FR 0957 10-27, ID 1000, nx; better than //5055 (Pappas-FL).
- 6170 CUBA R. Moscow relay, EG hrd 0145-0215 10-17 (Dickinson), 0415-0430 10-25 (Swaringen-NC).
- 6175 PERU R. Tawantinsuyu, 0935 10-24, huaynos, many TCs, IDs (Reinstein-FL); 0944 10-27, hardcore OA stuff, ID, "Arriba Peru" shouts, good prgmng at fair lvl (Pappas-FL).
- 6179 ARGENTINA R. Nacl Mendoza, LA mx 0815 10-21, full ID 0830, Abba (Sharpe-CA).
- 6180 VENEZUELA R. Turismo, 0930 10-27, ads, etc (Pappas-FL); pops, ID, 1150 10-20 (Prath-FL).
- 6188 PERU R. Oriente, 1041 on 10-24, near local lvl, "Peru Amanecer," nice mx (Reinstein-FL).
- 6190 UN UN Radio, \*0230 in Swahili; site? (Green, 11-1).
- 6195 SINGAPORE BBC PLS, poor 1711 11-1, BEC WS prgmng, //9740 (Palmer-WA). ++ 73, and Happy Holidays!



# LOG REPORT

## section C

6200 to 11699 kHz

Editor: David L. Walcutt, 211 West 56th, Apt. 36-F, New York, NY 10019

Last month's column was done by Peter Drizhal of Wheaton, MD. Many thanks for a job well done!

Special acknowledgments to the following contributors, whose loggings got delayed in the shuffle last month: David Alpert, Jerry Berg, Arthur Bonnet, Derek Lynoh from IRELAND, Richard Dickson, John Moritz, Richard Wood, & Don Vest. Though it is not possible to backtrack, they are appreciated.

- 6200 NICARAGUA R. Sandino; 0020-0815 SP, LA mx, ID's, political talk;g (Dickson 11/4, Erwin 10/8, Sharpe-CA 10/21).
- 6205NF GREECE VOG; 0145-0221 GK, mx, ID; //9420 (Alexander 11/4, Rigas 11/4)
- 6225NF GREECE VOG; \*0400 GK, IS, NA, ID, nx; //7370, 9420 (Rigas 11/4); 0420 GK, mx, tlk (Alexander 11/4); also at 2130 (Berg 11/4).
- 6229.8 CLAND R. Monimbo; 0005+ SP, pop & romantic ballads, political sp speeches (Jordan 10/11); 0038 SP, good w/ID & anti-Sandinista talk (Rigas-IL 10/8); 0220-0300\* SP pop mx, talk by W (Alexander 10/29). 0205-0255 SP, variety of mx, ID's by W as "Radio Monimbo, La Voz de la Democracia Libertad" (Valko 10/15); talk with references to Nicaragua, ID at 0319 and sign/off (Field-MI 10/25).
- 6250 EQ. GUINEA 2033 SP, Malabo pretty good, African & soul mx, into int'l & local nx 2100-2116 (// to Bata-4925 during that period), back to local mx 2116, NA 2200, 2203\* (Berg-MA 10/14); \*0507-0521 SP NA followed by s/on ID as "Radio Nacional", into lively SP vocals, another ID 0514 by same M & more vocals (D'Angelo-PA 10/7).
- 6272.0 PERU R. Guayabamba; 0315-0325 SP, tentatively w/bits of OA vocals w/M DJ (Forsgren 10/24); (no time -ed.) musical pgm, ID as "Radio Huayabamba" heard twice; not heard since (Field 10/19).
- 6299.5 CLAND LV del CID; 0001-0530 SP, R. Camilo Cienfuegos (7 reporters).
- 6323a PERU Estacion "C"; 0300 mx, ID at 0329 & s/off (Field 10/18, 10/19)
- 6364v UNID Peruvian; 3 conflicting reports, two from Sept.; Moderna? @1100 IN RIB Codina says this is Est. "C" with former Moderna xmr -ed.
- 6556 CLAND R.F. Marti/R. Venc.; 0010-0055 SP, political & rev. talk, vocals & revolutionary mx; El Salvador? (Dickson 10/17, 10/19).
- 6600h GUATEMALA TGNA, 2 x 3300, which was very strong (Sams 9/27).
- 6724.3 PERU R. Satellite; 0232 SP, lots of reference to Santa Cruz, W with OA vocals, quick ID at 0252 (Forsgren-WI 10/5). Fay:dlw.
- 7025 CHINA PLA 2; 1059 CH, marching type CH mx, time pips on the hour, ID by M, M&W nx, talks (Prath 10/27).
- 7050 CHINA PPBS Minority Lang.; 1648 Uighur?, S.Asian-like mx by M w/ stringed instrument; //4735 (Park-HI 10/19).
- 7065 ALBANIA R. Tirana; 0022 EG, cmntry on US sabotage (Feeley 10/12).
- 7080 CHINA RB; 1640-1656 Hindi; W w/classical mx by Russian composers, IS by W and off 1656 (Sharpe-CA 11/4).
- 7090 ALBANIA RT; \*0430-0455\* Greek ID, nx, cmnt, Alb. folk mx (Wood).
- 7090 PAKISTAN RP; 1555 UR economic talk; used EG words like "Quality control", "performance", "Million"; //5095 (Wood-HI 10/20).
- 7100 IRAN VOIRI; 0300 Parsi ID, items by M&W; 0325 IS (Wood 11/4).
- \*7110 INDIA AIR Delhi; 1118-1140\* lang; per tip from Jerry Berg; somber Indian vocal mx to 1130, "5-1" time pips w/last pip higher pitched; nx in lang to 1135 followed by EG ID & into EG nx to 1140\*; very good signal! Sked seems to vary widely as heard \*1122 sometimes and 1200\* sometimes (Reinstein 11/3); 1123 IS, tone 1126, IS again 1128, 6 pips 1130, ID & nx in (I think) Tamil to 1135 the EG development nx, followed by special wx for Everest expeditions; best singal ever from AIR below 31 mb; most AM's (Berg 10/14+).
- 7115 USSR RM N.Am. Sce; 0100 EG, world nx on Mrs. Ghandi (Dickson 11/2).
- 7115 BULGARIA R. Sofia; \*2130 EG, IS, ID, nx (Trotto 10/12); 0415 EG, propaganda items about USA (Hunt 10/14); \*0530 Turkish ID (Wood 10/20)
- 7120 ALBANIA RT; 0230-0235 EG to N.Am. (Hunt 11/3, Dickson 11/8).

- 7130 GERMANY FR DW; 1628 Parsi; ID, IS, nx (Park-HI 10/25).
- 7130 SEYCHELLES FEBA R.; 1724-1731\* Malagasy?, rel pgm w/Western-style & Polynesian singing, Indonesian-like talk; ID "R. Feba" (Park 10/26).
- \*7140 UZBEK SSR; Vatandosh Radiostantsiya (Compatriot R.), Tashkent; \*1700 IS, into "khabarlar" (nx); for Uzbeks abroad; is Tashkent's equivalent of all-Soviet R. Rodina; g (Wood-HI 10/20).
- 7145 POLAND RP; 0420 PL, interview on Warszawa; reception of RP in HI seems better than in parts of mainland U.S.; //9525 (Wood-HI 10/8).
- 7150 UKRAINIAN SSR; RM via Simferopol; 0130-0200 EG, N.Am. Sve.; abt the "Intercosmos" space pgm; site is per UHN (Dillon-DC 10/13).
- 7160 MONACO TWR; 0622 EG, tune-in to music box IS, ID at 0625 & "Thought for the day"; "The Sacred Page" at 0630 (Alexander-PA 10/20).
- \*7165 NEPAL R. Nepal; 1440 Nepali/EG, lcl folk mx w/chatter & laughter between songs; W w/ID & nx in EG at 1450; //5005 (Park-HI 11/3).
- 7165 SEYCHELLES FEBA R.; \*1827 PT, IS, ID's; full ID "Escuela R. Feba"; religious program; QRM BCC 7160, unID 1770 (Park-HI 10/26).
- 7170 NEW CALEDONIA R. Noumea; 0815-1245 f/o FR, pop mx, TC's, good (Forsgren-WI 10/27, Dillon-DC 10/13, Trotto-FL 10/13).
- 7172v, T ANGOLA ER do Lobito; 0504-0525 presumed PT, M w/tlk, chimed signature notes 0505 then report-type talks by M, possible ment. of Angola besides ID's; very poor and tentative (Jordan 11/3).
- 7175 SICILY RAI Radiodue, Catanissetta; 0514-546 IT, vocals & soft instrumentals w/occasional tlk by M; at 0530 5 pips then pause and sixth pip; nx until 0536; ID by W as "Radiodue" (D'Angelo 10/6, 10/7).
- 7180 SINGAPORE BEC W.S.; 1105 world nx, "New Ideas" (Park-HI 10/28).
- 7195 SAUDI ARABIA BSKSA; 0315 end call to prayer, into FA nx (Wood 10/28)
- 7195 USSR; RM; \*0300 "Radio Kiev" in EG to N.Am. following RM N.Am. Sec.; g (Alpert 10/1); 1158 "R.S. Peace & Progress" in CH; IS, W with ID, USSR Far East site presumed (Park-HI 10/26).
- 7200 SOMALIA Radio Mogadishu; 0255 test tones; 0300 NA, ID, Qur'an then local mx (Johnson-TX 10/23); \*0300 NA, Somali ID, into adhan (call to prayer); g (Wood-HI 11/4).
- 7200 USSR RM Mayak; 1430-1500 RS, Republic nx, mx, Moscow time and IS; site is Yakutsk per UHN Legge (Sharpe-CA 10/12).
- 7204.8 ZAIRE R. Lubumbashi; \*0357-0430 FR, heard several nites s/on but ham QRM prevents ID; rptd on this exact fqy some time ago; unID (Wilkins-CO 10/12); 0400-0429 FR, M, hilife mx; 0405 bells followed by a religious program; fair (Bolland-FL 11/4).
- 7210 NORWAY NRK; \*0555 IS, NW/EG ID, 0600+ NW nx; //9590 (Wood 10/24).
- 7215 IVORY COAST RTI; 0605-0650 FR, lcl mx, tlk (O'Brien 10/15, Wood).
- 7215 USSR RM; 2335 W.S.; mx, ID (Trotto 11/4); 0245 N.Am. Sve. (Dickson)
- 7225 TUNISIA RTV2; 0430 AR, MA, s/on, Qur'an; VOG QRM (Swaringen 10/29).
- 7235 TURKEY VOT; 0300 IS, s/on, unid lang.; strong (Alpert 10/1).
- 7245 ANGOLA RNA; 1625 PT, futebol match; //9535, both g (Wood 10/28).
- 7245 LIBYA SPLAJBC; 0235-0305 AR, tlk by M abt foreign affairs, ID 0258: "Sawt ul-watan il-kebir"; //3200 (Dillon 10/13); 0140 cmntry by M with mx interludes, referrals to "el Arabjyah" (Gray 11/2).
- 7250 CHINA CPBS; 0750 CH report on parade, 0800 time sig., nx (Wood 10/11)
- 7255 BOTSWANA RB; \*0347 barnyard IS, NA 0358 & s/on anmts, hymn & religious pgm; //4848 (Daly 10/20, Gray 11/2, Wilkins 10/27, Bobb 11/1).
- 7255 NIGERIA VON; \*0455 drum IS, s/on w/African Sve, pop mx (Daly 11/2); 0533 EG, nx, political cmntry: "This cmntry coming to you from the World Service of Radio Nigeria" (D'Angelo 10/6); 1950 EG, news about Nigeria, commentary at 1955; good signal but QRM (Alcorn-NJ 10/20).
- 7259 MONGOLIA RUB; 0750 AR (!), mx, 0800 Mongolian anmt, six equal short time pips, M ID "Ulean Baatras yarsh", pgm sked, into "khabar" (nx; good (Wood-HI 10/11). Good luck with the solar project! -ed.
- 7259 VANUATU R. Vila; 0715 Bislama (Pidgin) nx by man, drift from 7260; //3945; good (Wood-HI 11/1) 0730-0830+, EG nx 0800 (Field 10/15).
- 7265 GERMANY FR Sudwestfunk; 0734 GM, U.S. lite rock & MOR tunes w/M DJ (Peppas-FL 10/12); 0445-0501 GM, pop mx, time pips, ID (Swaringen).
- 7275 KOREA REP RK; \*0615 EG, US ancr, list freq's including 15575 (Wood 10/24); 1134 EG, Susan Hall & Han Hee Chu w/"Shortwave Feedback" (Park 11/4).
- 7335 USSR RM; 2352, awesome signal for N.Am. Sve. & right atop CHU! Noted //7320, 7215, 7195, 7165, 7150, 7115, 7100, so why QRM a time stn??? (Reinstein 11/3); 2335 EG, US/Soviet cmnt; good QRMing CHU (Trotto 11/3); UZBEK SSR Vatandosh R. (Compatriot R.), Tashkent, 0255 khabarlar (nx) in Uzbek, 0258 request rpts to Vat. Rat., Tashkent; 0300 into Parsi pgm; g, over CHU (Wood-HI 11/4).
- 7345 CZECHOSLOVAKIA RP; 0310 EG, mx for taping; g (Dickson 10/28).

- 7365 SYRIA 2240-2330\* AR, AR instrumental mx, s/off anmt & anthem following call to prayer at 2318 (Forth 10/8, Jordan 10/15).
- 7370 GREECE VOG; 1615 Serbo-Croatian nx, 1630 into Bulgarian; Balkan sve.; beautiful audio; //9420, 11645 (Wood 10/28).
- 7384 USSR RM feeder to Bulgaria (per UHN 55); 0250 SP, newlike talks, ment. Moscow, close-out anmts (Jordan 10/11). Also is ISB (Jordan).
- 7390 PIR. Zeppelin R. Worldwide/74-WKUE; 0019-0203\* (McLemore 10/13).
- 7400 CLAND CID: R. Camillo Cienfuegos; 0400-0500\* popular LA mx, ID's at 0432, political talks & poetry; powerhouse (Erwin-VA 10/20).
- 7412 ISRAEL KI; 0200 EG, nx, tlk of rising inflation (Hunt 10/14).
- 7412 PIR. "KRUD"; 0135 acid rock, overmodulating (Gray 10/29).
- 7420 PIR. V. of Laryngitis; 0005-0035 polka version of "Do-Re-Me", Genghis Huxley & Cowboy Stan w/election returns, seal s/o (McLemore 11/7)
- 7425 PIR. R. North Coast Int'l; 0025 rock mx, reverb ID, final ID 0033 anno. POB 245, Moorhead, MN 56560; Sunday local time (Berg 10/8).
- 7425NF SYRIA SARBS; 2038-2104+ w/strong signal; many ID's, Arabic mx, headlines etc.; ex-7365; tnx Daid Potter (Reinstein 10/24); 2214 AR, fair w/mixed bag of mx & AR tlk; in the middle of the pirate meter band (Rigas-IL 10/28). Maybe this is one... -ed.
- 7430 PIR. Secret Mountain Laboratory; 0020-0103 jazz, folk (McLemore 10/28)
- 7430 PIR. No ID heard; 0050-0100\* bagpipe mx w/flutes; "This about wraps up this text xmsn. Be back on the air with a new pirate station in December"; good signal (Woods 10/30).
- 7435 PIR. "WMTV"; 0334-0418 rock mx, several xmsn breaks, ID & address: c/o John, POB 1945, Del Ray Beach, FL 33444 (Plum 11/1); 0500 good w/rock mx, ID's; heard frequently lately (Rigas-IL 11/4). 0522 EG, rock mx, ID, Florida address for reports (Alexander 11/4). 0605 "south Florida's alternative on SW" (305)-936-1812 (Berg 11/4).
- 7450 SPAIN SFR/REB; 2335 EG, abt Spanish classical mx (Alcorn 10/21); 2253 FR into EG 2300 (Rigas); 2303 EG, music (Levison-PA 10/21).
- 9009 ISRAEL KI; \*0300 unid lang., news program (Jones 10/15).
- 9375 USSR RM; 0050 "Radio Kiev" in EG, mx, ID, sked; 0100\* (Alcorn 10/28)
- 9385 ISRAEL KI; 0605 HB nx, ment Likud Party; g (Wood-HI 11/5).
- 9390 CHINA RB; 1645 Hindi talk on Tienanmen Square; g (Wood 10/20).
- 9420 GREECE VOG; 1925 EG/GK, int'l nx by M, ID "to listeners in Europe" (Alcorn 10/13); 2330 GK/SP, ballads, ID at 2340 into GK (Dillon 10/28); 0130 EG, nx, GK/US relations (Dickson 10/10); 0415 GK sports mention Olympics; //9855; good (Wood-HI 10/24).
- 9430 ALBANIA RT; 1930 PT, sign on anmts in PT (Green 11/3).
- 9440 ISRAEL KI; 0105 EG, nx focusing on rocket attack on Arab bus (Alcorn 10/29); 0200 EG, life of Jews in Russia (Hunt 10/10).
- 9460 GREECE R. Stn. Macedonia; 2145-2212\* GK, poor with relay of Greece's domestic national program; 2200 nx (Rigas-IL 10/28).
- 9475 EGYPT R. Cairo; 0145-0245 SP/EG to Americas (5 reporters).
- 9480 ALBANIA RT; 2215 EG, long-winded cmtry by W (Alcorn-NJ 10/28).
- 9481 ALBANIA RT; \*0430-0455\* EG nx, tnx to those greeting Enver Hoxha on his 76th birthday; //7300 (Wood 10/20). Jeese I forgot again! -ed.
- 9485 PAKISTAN RP; \*1645 EG, ID as "Western Sve. of RP greeting listeners in the UK, W. Eur., Turkey & N.Afr.;" //9485, 12015 (Wood-HI 10/16).
- 9490 USSR RM; 0145 SP, ID 0200 then nx; //9470 (Daly 10/16); 1205 Mayak pgm, nx & tlkx by M&W; //4765 until 1215 (Prath-FL 10/20).
- 9495 MONACO TWR; 0828 EG, rel pgm, ID by M (Trotto 10/18).
- 9499.6 ALBANIA RT; 2158-2213 SP for Iberia, W ancor, nx for & abt Spain; 2204 "Aqui Tirana"; I was most surprised to find them audible here this time of day (2 pm local); maybe dx season here! (Palmer 10/30).
- \*9505 PERU R. Tacna; 0930 with "Melodias del Peru", fast-moving OA mx pgm, ads, TC's, promo as "R. Tacna, primera en sintonia" etc.; not heard every day; strong (Berg-MA 10/12).
- 9505t ZAMBIA ZBS; 2048-2101\* EG/Vern, pop & reggae tunes hosted by M DJ, brief closing anmts: "... Broadcasting Services", MA (Pappas 10/24).
- 9510 PHILIPPINES FEBC; 2202-2224 IN, slow 3/4 waltz time vocals with what I assume were gospel words in IN; I can see why FEBC is so popular in Asia - they are not hard sell like WYFR (Palmer 11/2).
- 9515 MALAYSIA RM; 0845 ML interview w/Filipini (Wood-HI 10/12). 1208 EM radio drama w/western mx during breaks; //9665 (Park-HI 10/20); 1517 Malay pop vocals, ID by W, nx by M (Sharpe-CA 10/23).
- 9535 NETH. ANTILLES TWR; \*0500 IS, ID; //800, 11895; all g (Wood 10/12).
- 9545 BRAZIL R. Univerao, Curitiba; \*0700 PT ID, into evangelical sermon; no sign of SIBS (Wood-HI 11/8).
- 9545 SOLOMON IS. SIBC; 0700 EG, ad for Kelvinators at appliance store; national wx; big band instrumentals (Park-HI 11/5).

- 9550 CHILE RN; 0250 SP, "Nacional de Chile informa la Temperatura en Santiago"; romantic mx, chimes IS 0301; over Havana (Wood-HI 10/10).
- 9560 ETHIOPIA VORE; 1640 AR nx w/strange Ethiopian accent; list loggers usually misID this stn as long-inactive Amman, Jordan (Wood 10/16).
- 9570 KOREA REP RK; 0848-0850 EG/PT, nx (Park-HI 11/5, Wood-HI 10/12).
- 9570 ROMANIA RB; 0228 EG, piano mx (Levison-PA 11/1).
- 9580 AUSTRALIA RA; 1215-1510 EG, "Shortwave Feedback", mx pgm etc. (Pate 10/21, Parks 11/3, Dillon 10/28); 2118 EG, ARDXC dx tips (D'Angelo).
- \*9587.3v EL SALVADOR R. E.S.; 2344-0315+ SP (an incredible 15 reporters!); (Dickson 10/9); regular here in PM's (Forsgren-WI 10/19); TC's generally 2 minutes slow (Berg 10/6); (Jordan 10/10); ID after every song (Cobb 10/23); (Wood 10/11, Paszkiewicz 10/21, Prath 10/23); first noticed weakly around 0600 but too weak to ID, excellent to-night (Palmer 10/22); (Emkenhus 11/1, Alexander 10/27); //655 MW (Wilkins-CO 10/30); strange SP PSA's between songs such as "Rejuvenating the economy benefits all"; also noted other times on 5991.9 (Reinstein 11/4); (Rigas 10/21, Teasley 10/20). Gone 0225 11/21!:-ed.
- 9611 INDONESIA RRI Jayapura, Irian Jaya; 0600 IN, ID, nx (Wod 11/5).
- 9618 MOZAMBIQUE RM; 1751 PT/EG, xylo IS & quadrilingual ID's, theme, sked, nx (Park-HI 10/8); 1840 EG interview ANC official (Wood 11/9)
- 9620 NEW ZEALAND RNZ; \*0930 EG, IS of bird, ID, Nat. Sve. (Trotto 11/2).
- 9629.6 CHILE R. Agricultura; 2319-2332\* booming in nightly now; SP M anc reading "cartillas" from Santiago listeners; several ments of R. Agricultura de Los Angeles" & TC "en Agricultura" (Reinstein 10/26).
- 9630 SPAIN REE; \*2355-0215 EG/SP to N.Am. (6 reporters).
- 9640 SWAZILAND TWR; 0330 SW into Somali (Wood-HI 11/5).
- 9654 PERU R. Nor Peruana; \*1056 w/either very long version of IA NA, or NA rpt'd twice; a patriotic-type vocal at 1100 with talkover by gal then ID & freqs by M in low-audio amnt; OA mx (Berg 10/29).
- 9660 TURKEY TRT; 2200-2230 EG, nx, lbr, QRM Rumbos (Hunt 10/31, Trotto); 2220-2235 EG, ID 2228, at 2229 the W said "Good-bye" in Turkish as she has at the end of every VOT pgm I've ever heard in EG; however special amnt at 2232 re; rescheduling of EG xmsms to one hour later as of 1 November, so this would be at 2300 now (Palmer 10/30); 2237-2245 EG, "DX Corner", music (Parks 10/13, Levison 10/13).
- 9660 VENEZUELA R. Rumbos; 1310-0304 SP, pop mx, ade (7 reporters).
- 9665 SAIPAN KYOI; 1615-1633 JP/EG, the ID's, quite often heard, are pronounced "Choi" if done by the W in JP, or "Kyoj" by the M in EG; strange layout; (Palmer 10/26); 1624 rock (Gray 10/10). 9670, 2200+ QATAR RQ; \*0245 AR, anthem, ID "Idhast ul Qatat min al Dawha tohayekum", list day's pgms; good (Wood 10/11).
- 9675 EGYPT RC; 0120-0135 EG, AR by radio lesson #64; exo (Hunt 10/11).
- 9675 PERU R. del Pacifico; 1145 SP, very nice sig w/ID (Berg 10/28).
- 9683.5 TANZANIA RT; 1900 EG, ID, drums (Wood 10/22); 1601 EG (Park 10/8).
- 9690 ARGENTINA RNA; 0700 SP, ID for home sve. ment MW 870 (Wood 11/8).
- 9705 MEXICO RM; 0122-0250 SP, features (Dickson, Forsgren, Niekamp 10/25)
- 9715 PHILIPPINES FEBC; 1350-1410 Mandarin, W w/rel message, gospel mx in CH, IS 1259 & opened again in CH (Palmer-WA 11/1). Welcome to FRENDX
- 9735 PARAGUAY R. Nacional; 2325-0100 SP (Levison, Wood, Feeley, Jordan).
- 9745 BULGARIA R. Sofia; 2135-2200 EG, topics (Dillon 10/28, Prath 10/28)
- 9745 CAMEROON RC, Yaounde; 2110-2120 EG/FR, M with ME & African nx, ID by W, nx in French by M; f (Bobb-MN 10/29).
- 9745 ECUADOR HCJB; 0230 EG, "DX Party Line" (Parks 10/7).
- 9745 KOREA PDR R. Pyongyang; 1012-1243 KR/EG (Park 10/30, Gray 10/30).
- 9750 KOREA REP RK; 1400-1435 EG, mx, M&W? "Bridge of Friendship" pgm Hunt 10/13, Parks 11/3).
- 9775 MONACO TWR; \*1300 EG/SP, ID IN EG into SP pgm (Alcorn-NJ 10/13).
- 9780 YEMEN ARAB REP R. San'a; 2015-2032 AR, M w/world & local nx, ID 2026 by W: "Itha'at ul-Jumhuriyyat il-Arabiyyat il-Yamaniyy" (Dillon)
- 9790 FR. GUIANA RFI relay; 0315-0330 EG/FR to Americas (4 reporters).
- 9815 ISRAEL KI; 0000-0515 EG etc., nx (6 reporters).
- 9820 CHINA RB; \*1200-1255\* EG, nx, mx from China (Jordan 10/13, Alcorn).
- 9855NF BANGLADESH RB; 1700 time pips, Bengali ID, nx (Wood-HI 10/22).
- 9885 SAUDI ARABIA BSKSA; 2127-2230 AR, ID etc. (Dillon 11/4, Green 11/4)
- 9890 LIBYA SPLAJBC; 2326-0220 AR, martial mx (Dillon 10/14, Purdue 10/7)
- 9905 USSR R. Tikhij Okean; USB, 1937-1955 RS magazine show (Park 11/3)
- 10040 VIETNAM Vokh; \*1800-1820 EG, ID, nx, cuntry, mx (McKellar-CA 10/13).
- \*11640 CLAND V. Libyan People; 1825-1848 AR mx, political talks, "Huna sawt ash-sha'abi al-Libi"; 15040 not heard today; strange noises (probably jamming) began 1840 (Palmer-WA 11/6).
- 11675NF USA VOA; 0000-0010 EG, ID, world nx, election report (Trotto 11/4).

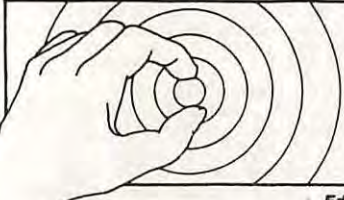

# LOG REPORT

## section D

### 1700 and above

Editor: Wallace C. Treibel, 357 N.E. 149 St., Seattle, WA 98155

- 11705 AUSTRALIA RA at 0946 in IN, rock mx, QRM Moscow 11715 (Park 10 13)
- 11710 ARGENTINA RAE in EG at 0200, nx about Argentina (Hunt 10/13)
- 11710 JAPAN R. Japan in EG 0000-0005, nx, current affairs (Zilmer 11/8, Alcorn 11/5)
- 11720 USA VOA in EG at 0157, Bush-Ferraro debate, QRM jammer 11720 (Park 10/12)
- 11725 CUBA RHC in EG at 0230, local & intl mx, not as strong as 11760 (Dickson 11/6)
- 11740 USA WQFC via WYFR in EG 0218-0221, nx, ID, mx, //5985 (Trotto 11/2), also hrd at \*0300 w/CH anthem, ID, nx, f, QRM: BBC relay Oman (Wood 11/4)
- 11740 PHILIPPINES VOA relay in Somali? 1855-1900\*, YL said "Somali" during s/off but Somali xmsn not listed in WRTH at this time block (Palmer 11/6) ED: Xmtr site presumed according to VOA time sked exp 9/24/84 listing Ea Afr xmsn this hr.
- 11740 OMAN BBC relay \*0300 local ID, into world sce EG nx, 0315 into FS nx, this freq only carries EG for this quarter-hour per day, g (Wood 10/28)
- 11743 PAKISTAN RP in Urdu at 0315, tlk on Pak/Ind/Bangla relations, 0325 IS back on, 0330 call to prayer, g (Wood 10/10)
- 11790 USA AFRITS Bethany in EG, Reagan-Mondale debate, QRM Brazil 11780 (Park 10/8)
- 11750 JAPAN AFRITS via FEN in EG 0430, NFL football (Park 10/22), 0330 w/DJ show, clear when BBC Ascension s/off at 0330, g (Wood 10/20)
- 11750 SEYCHELLES FEBA in Oromo? at 1730, IS & off, back on w/IS & ID's "Yeh FEBA Radyo" & relig pgm w/vern mx, QRM (Park 10/19)
- 11750 IRAQ R. Baghdad in AR 1900, cmty about Iran, ID 1907, desert mx (Gray 10/5)
- 11750 ASCENSION ISLAND BBC relay in EG 0200-0211, nx, ID, press rw (Dillon 10/31)
- 11755 USSR FE relay RM in EG 2030, mx, tlk by Soviet philosopher (Park 10/13)
- 11759 COOK ISLANDS RCI in Maori 0643-0800, island mx, phone-in request pgm, US pops, TC, no nx at 0700, same annrcs as hrd over 3 yrs ago, into nx in EG at 0800, (Valko 10/30, Atkins 11/3)
- 11770 INDONESIA RRI Jakarta in IN 0730, nx at dictation speed, g (Wood 10/25)
- 11775 CANADA BBC relay in EG 1645, tlk on oil prices, N Am xmsn, g (Wood 10/19)
- 11780 NORTH KOREA R. Pyongyang in JP 0400-0550\*, IS, ID, sked, anthem, preview, nx (Wood 11/9, Park 10/25)
- 11790 SEYCHELLES FEBA in Pushtu 1625, TC in Afghan & Pakistan time, IS (Wood 10/20)
- 11790 USA KGEI San Francisco in RS 1528-1540, ID in RS 3 times, relig messages, played rock "oldie" at 1537, beamed to Siberia (Palmer 11/1, Bobb 11/3)
- 11790 SOUTH AFRICA SABC in EG 0600, nx, short story 0700, QRM: AFRITS (Wood 10/24)
- 11790 GUM KTIWR in EG 0043-0057, DX Listener's Log & closing armt (Takeda 11/3)
- 11801 SRI LANKA SIBC in lang 1613, sub cont mx, ID, het RA 11800 (Sams 9/29)
- 11805 BRAZIL R. Globo in PT 0020-0051 in PT, excited tlk, ID, commercials, sports tlk (Feeley 10/12, Dillon 10/25)
- 11810 SEYCHELLES FEBA in SH 0311\*, IS 0312 & ID's, relig pgm, QRM 11815 (Park 10/22) also in EG 0405, cmtry about farming (Parks 10/7)
- 11815 LIBYA R. Jamahiriya in EG 2230-2325, ID, feature on foreign investment in Libya, weekly pgm "Probe", nx 2315, feature "Africa for the Africans" (Parks 11/4, Trotto 11/4, Green 11/4, Alcorn 11/4, Dillon 11/4)
- 11820 SOUTH KOREA RK ending pgm in GM at 0600, g (Wood 10/24)
- 11825 TAIWAN WQFC in EG 2150, Asian nx, cmtry on new Hong Kong treaty (Park 11/3)
- 11830 NORTH KOREA R. Pyongyang in CH \*0600, ID, nx, g (Wood 10/24)
- 11835 URUGUAY R. El Espectador in SP 0135, ads for "Relojes", g (Wood 11/9)
- 11850 WEST GERMANY DW in JP 1218-1229, mailbag and closing armt (Takeda 11/4)
- 11860 CHINA R. Beijing in EG \*0300, IS, ID, nx, xmsn to N Am, g (Wood 11/4)
- 11860 BULGARIA R. Sofia w/Bulgarian mx at 1032 (Levison 10/1) Lang?
- 11875 USA WYFR in EG 1306, hymn, "Open Forum", //11830 (Park 10/22)
- 11880 NORTH KOREA R. Pyongyang in FR \*0600, ID, nx, //9560, g (Wood 10/24)
- 11890 PHILIPPINES FEBC in EG 0830, Asian & world nx, "Shortwave Mailbag" (Park 11/2) "Back to God Hour" transcription, //21473, nx w/Filipino accent (Wood 10/28)
- 11900 USSR R. Magallanes in SP 0158, ID, vibraphone IS, ID, Andean mx, nx (Park 10/15) in EG 1400-1410, IS, ID, nx, p (Trotto 11/6)
- 11900 ECUADOR HCJB in Quecha 2230, ID, flute mx (Green 11/4)
- 11900 SAIPAN KYOI in EG/JP 1220-1515, rock mx, ID (Trotto 11/6, Green 11/4, Parks 10/13)

- 11905 BRAZIL R. Universo in PT 0105-0130, relig sce & mx, ID 0120 (Plum 10/28) also in PT 0400-0530+, impassioned speech w/roaring crowd, guitar mx (Jordan 10/11)
- 11910 AUSTRALIA RA in EG 0605-0610, world nx, ID, f (Trotto 11/6)
- 11910 USSR RM in EG 1915-1930, newsreel, g (McKellar 10/31)
- 11915 TAIWAN VOFC \*0600, anthm, nx in IN, //15125, both g (Wood 10/24)
- 11925 BRAZIL R. Bandeirantes w/US election coverage 0045-0120, VOA matl (Plum 11/7)
- 11930 NETHERLANDS RW Lopek IS at \*0725, 0730 DT to Europe, nx, g (Wood 11/4)
- 11940 ROMANIA R. Bucharest in EG \*1300, Eur sce, vg (Alcorn 11/3)
- 11945 CHINA R. Beijing in RS \*1900, ID, nx, jammed very quickly (Wood 10/22)
- 11945 UNITED KINGDOM BBC Eur sce in BG/SC 1704-1721, ID, nx, sig f/out (Palmer 10/24)
- 11955 UNITED KINGDOM BBCWS in EG 0843-0910, "John Peel Show", nx, g (Trotto 10/18)
- 11960 ALBANIA R. Tirana in EG \*1230, nx, political tlk (Prath 10/21)
- 11983 ALBANIA R. Tirana in FS at 2059 s/off (Sams 10/7)
- 11984 EL SALVADOR R. El Salvador in SP 1920-2220, SP ballad, ID, abrupt s/off in mid-sentence at 2222 (Trotto 10/14, Wilkins 11/1)
- 11991 NORTH KOREA R. Pyongyang in EG \*0600, ID, pgm sked, nx, //11660, f (Wood 10/24)
- 12000 USSR R. Peace & Progress in EG \*1630-1650, g, //11950, f, IS on clarinets, ID spoken very slowly, live interview of WW II vet, mx, beamed to Afr (Palmer 10/30)
- 12015 PAKISTAN RP in EG 1845, film mx, to UK, Eur, N Af, ME, g (Wood 11/9)
- 12015 AUSTRIA ORF in GM 1430, folk mx, ID, tlk (Prath 10/27)
- 12030 USSR RM Far East in EG 0542-0600, "Listener's History Club", mx (Sharpe 10/13)
- 12030 SWITZERLAND SRI in EG 1330, Grapevine pgm, Swiss mx (Alcorn 11/3)
- 13635 USSR R. Moscow 1530-1600+ in RS, Soviet home sce w/IS at half hour, IS 1600, nondescript mx, tlks, p (Sams 10/7, Jordan 10/14)
- 13645 USSR R. Moscow 1225-1305 in lang, IN (FRENCH 11/84) gives more details on languages xmtd to Afgh & S As, pop mx, ponderous orch mx, tlks, IS, nx (Rigas 10/21, Jordan 11/5) also in Dari? 1520-1630, IS (Sams 10/7)
- 13650 USSR R. Moscow in EG 1545-1607, //13680, 11840, Kremlin bells, ID, sked, nx, "Lots of Soviet activity on this band at this hr" (Jordan 10/14, Sams 10/7)
- 13660 USSR R. Moscow Intle in FR 1722, mx, ID, cmtry on US (Park 10/8)
- 13680 USSR R. Moscow in EG 1530-1545+, xmn to SE As, sked, tlk, mx, f-p, (Jordan 10/14)
- 13685 FRANCE French Telecommunications Network in EG/FR 1750, test xmsn for circuit adjustment (SSB) (Alcorn 11/6)
- 13745 CLANDESTINE R. Iran in FS 1220-1315, tlks, many ments of "Radio Iran", brief AR mx, EZ mx, ID 1230, nx, speech 1240, march mx 1250 (Jordan 10/16)
- 13797 ICELAND ISBS Reykjavik in Icelandic 1818-1950, tlks, poss nx rpts, EZ mx filler, speech, choral mx, sudden s/off 1950 (Jordan 11/4)
- 15049 CLANDESTINE V. of the Mujahed of Iran, 1625\* abruptly after FS ID "Inja Seda ye Mujahed e Iran ast", patriotic chorus, g (Wood 10/30)
- 15055 UNIDENTIFIED This one has been reported variously as HCJB, WYFR, and R. Milano International in Italy. Rptd from 2245-2300\* in EG w/deep trans-Pacific fade and WYFR theme song "To God Be the Glory" (Palmer WA 10-22) ID as WYFR at 2200 with bible study pgm in EG (Palmer 10/24) 1950-2010 in SP, ID as HCJB, //15160; 2240-2300\* in EG but WYFR theme song again (Palmer 10/30) 2215-2300\* in EG with relig pgm, no ID but presumed to be "R. Milano International" (Erwin VA 10/20) ED: Palmer notes this one as a spur on 11/2 but as a fundamental on others?? Is it possible that one of the religious stations is playing tapes from the other, or are they sharing this frequency??
- 15073 USA Pirate "Secret Mountain Laboratory" in EG 2011-2032, nuclear war parody, Irish folk tunes, ID, g (Forsgren 11/3)
- 15090 ECUADOR HCJB in SP 1956-2003, children singing, ID, //15055, 15125 (Valko 10/24)
- 15106 EQUATORIAL GUINEA R. Nacional de Guinea Ecuatorial-Bata \*1656-2200\* in EG/SP, US & Can relig pgms, Abba mx, ID, vg (McLemore 10/8) relig tlks, hymns (Jordan 10/15) ID as "L Voz de Bata", anmnts in EG 1730, g sig but not heard every day (Valko 10/22) pop mx, ID's, gave addr as Box 441, Bata, NA 2157 (Wilkins 10/26)
- 15115 ECUADOR HCJB in EG 1432-1500, "Through the Bible", ID, g (Bobb 10/25)
- 15119 NIGERIA VON in EG 2140-2205, nx, cmtry on government's helpful policies, mx at 2200, g (Teasley 10/21)
- 15135 PHILIPPINES R. Veritas Asia in JP 0014-0027, mailbox pgm & s/off (Takeda 10/27)
- 15140 INDIA AIR in FS 0358, IS, ID "Inia (pause) Delhi", Qu'ran (Park 11/4)
- 15140 CHILE R. Nacional in SP 1645, nx of Augusto Pinochet's visit to Banco Central (Wood 10/22) 2355-0135 in SP, EZ mx, ads, rock, nx (Feeley 10/12, Cobb 10/14, McKellar 10/22, Palmer 10/20)
- 15140 USSR R. Moscow Far East in EG 2205, nx, feature, QRM Chile (Park 11/3)
- 15145 EAST GERMANY RBI in AR/SH 1652-1733, rock & upbeat mx, ID "Huna Berlin", nx, cmtry (Palmer 10/26) 1815 in EG, nx, press comment, DX Corner (Zilmer 10/28)
- 15150 CHILE R. Nacional in SP 1427-1432, mx, nx, p (Niekamp 10/24)
- 15155 ECUADOR HCJB in EG 0230, DX pgm, feature on BBC, NRC rpt (Park 10/21)
- 15155 EGYPT R. Cairo in Somali 1645, ID, AR mx, g (Wood 10/31)
- 15160 AUSTRALIA RA in EG 0330-0400, wx, discussions, g (Dickson 10/28)

- 15160 MEXICO XEWV 1715 SP rancheros, back from 15177v. g (Wood 11/8)
- 15165 INDIA AIR Bombay in Gujarati 0340, mourning mx for Indira Gandhi, //17805, g (Wood 11/4) in Hindi \*0310, IS, ID, scmbcr mx, EG nx 0345, chanting (Park 11/1)
- 15170 TAHITI Papeete in FR 0300, South seas mx, YL anncr (Hunt 10/5)
- 15175 MEXICO L V de la Amer Latina in SP 2245, bullfight coverage, ads (Prath 10/28)
- 15185 USA WINB in EG 2100, EZ mx (Feeley 10/8)
- 15190 SAIPAN KYOI IN EG/JP \*0300, ID, anncd this freq after change from 15405, rock mx, g, but QRM R. Japan 15195 (Wood 11/5)
- 15200 SEYCHELLES FEBA in SH after \*0500 IS, ID, sermon, g (Wood 11/8)
- 15215 USA WYFR in EG 2002, chitchat, acapella spiritual, Bible pgm, g (Park 11/4)
- 15220 NORWAY RNI in NO 1645\*, ID in EG, g (Wood 10/30)
- 15220 FRANCE RFI in FR 2330-2400, Journal Intl et Revue, Carrefour, g (McKellar 10/15)
- 15220 TURKEY VOT in TK 1515-1555, nx, TK mx w/YL DJ, piano IS 1554, f (Dillon 10/27)
- 15225 TUNISIA RTT in AR 1943-2030, AR vocals, ID 2027, g, //7225, p (Cobb 10/28)
- 15240 AUSTRALIA RA in EG 2330, nx, mx, //15395, 15320, 15115 (Zilmer 11/3)
- 15255 EAST GERMANY RRI in FR 1714, IS, ID, sked, nx, QRM BBC 15260 (Park 10/29)
- 15260 JAPAN PEN AFRTS in EG 0311, delayed bcst of World Series, p (Park 10/15)
- 15265 FINLAND RF in FN 1645, lite mx, f (Wood 10/30)
- 15280 SINGAPORE BBC relay in EG 0914, pgm preview, "Waveguide", p (Park 11/5)
- 15280 USA KGEI in SP 2203, nx, full ID, Latin mx, magazine show, f (Park 10/13)
- 15285 BRAZIL R. Nac de Amazonas in PT 1615-1655, sporting event, ID, f (Bobb 11/3)
- 15300 CUBA RHC in EG 0240+, tlk about Chilean struggle, "Spotlight on LA", LA nx, "Information Package" (Dickson 10/21)
- 15300 FRANCE RFI in FR 1856, DJ airing Wang Chung mx, folk mx, jazz mx, ID and freq anmnt, //15435, p (Park 10/28)
- 15300 UNITED ARAB EMIRATES R. Dubai in EG 1610, reception rpts, tlk on how different freqs are hrd around the world, //15320 & 21605 (Alcorn 10/14)
- 15305 MONGOLIA R. Ulan Bator in EG 1300, into mx at 1310, weak sig (Alpert 9/9)
- 15310 GUINEA La Voix de la Revolution in EG 1826-1855, nx, rock mx, QRM from RFI at 1530, in the clear before that (D'Angelo 10/14)
- 15315 FRANCE RFI in EG 1625-1655\*, "Paris calling Africa", mailbag, ID, mx, tlk, (Trotto 11/4, Alcorn 11/4)
- 15320 AUSTRIA ORF in EG 1210-1230, nx, mx, tlk about Austria's relationships with Poland (Lineback 10/20, Hunt 10/27)
- 15325 CANADA RCI in EG 2230, "As It Happens", QRM R. Japan 15320, p (Park 10/8)
- 15333 COLOMBIA R. Nacional in SP 2310-0100, EZ mx, //9635, ID in SP, classical mx, (Prath 10/24, Wood 10/12)
- 15340 NORTH KOREA R. Pyongyang in AR \*0400, ID, sked, nx, g (Wood 11/9)
- 15350 LUXEMBOURG RTL in FR 1735-1804, DJ w/FR & EG pop vocals, ads, nx (Enkenhus 11/3)
- 15355 WEST GERMANY DW in GM 2034, IS, ID, sports rpt, QRM both sides (Park 11/4)
- 15355 USA KGEI San Francisco in EG 0100, nx, f-p (Daly 10/17)
- 15355 NETHERLANDS ANTILLES TWR in SP 2254, IS, ID, relig pgm, p (Park 10/18)
- 15355 USA AFRTS Delano in EG 0202, Mondale-Reagan debate, "Meet the Press" (Park 10/8)
- 15380 SINGAPORE BBC relay in HD/EG 0256, ID, nx (Park 10/17) 0145 in EG, "The World Today", feature on Chile, g (Wood 11/9)
- 15390 ASCENSION ISLAND BBC relay in EG \*2130-2205, spec pgm to the Falkland Is, into PT to Brazil at 2200, f, //11820 (Palmer 10/30)
- 15395 AUSTRALIA RA in EG 0330-0400, Melbourne Cup horse race, also relay by RNZ, vg //15320, 15240, 15160 (McLemore 11/6)
- 15395 SPAIN RNE in SP 2000, noticias internacionales (Green 11/4)
- 15400 ASCENSION ISLAND BBC relay in EG 2000, nx (Green 11/4)
- 15405 SAIPAN KYOI IN EG/JP 0300, anncd this freq closing, switch to 15190 (Wood 11/5)
- 15405 USSR R. Rodina in RS 2345-0030, choral mx, tlk, classicals, RS mx (Jordan 10/25) also in RS \*2330, IS, ID "Govorit Radiostanzia Rodina", nx, tlks (Prath 10/23)
- 15415 NORTH KOREA R. Pyongyang in CH 0601, NA, ID, nx, co-channel QRM, p (Park 10/7)
- 15420 USA WRNO in EG 1940, ad for "National Business Employment Weekly", g (Wood 10/11) also in EG 1730-1735, ID, Saints-Rams football game, f (Trotto 10/14)
- 15425 SRI LANKA SLBC in EG 1530-1600\*, relig pgm "Back to God Hour", ID (Woods 11/2) also in EG 1505-1603\* w/Asian nx, ID 1510, pop mx, NA at s/off (Enkenhus 10/28)
- 15425 USSR R. Moscow in EG 0000, tlk, sports, nx, Moscow Mailbag (Dickson 10/22)
- 15435 UNITED ARAB EMIRATES R. Dubai in AR 0515, fanfare, nx, lite mx, g (Wood 10/20)
- 15445 LIBERIA VOA relay in EG 2240-2250, Jazz hour, exc (McKellar 10/4)
- 15450 LIBYA R. Jamahiriya in EG 2300-2347\*, tlks abt solidarity & political policies of the Arab nations (Hunt 10/10) off abruptly after ID at 2347 (Trotto 10/12), also in AR 2155-2231, world nx, ID, AR mx, f (Dillon 10/21)
- 15495 KUWAIT RK in AR 0400, ID, Qur'an recitation, g (Wood 11/9)
- 15520 CHINA R. Beijing in EG 0006, world nx, exc (Feeley 10/13)
- 15525 SPAIN REE in SP 1640, rpt on Iberia airline, g (Wood 10/15)

- 15560 NETHERLANDS RN via Flevo 1632-1732 EG/SP/DT/FR/PT/AR/IN test pgm, ID's in eight languages, Golden Earring mx, req rpts, exc (McLemore 10/26)
- 15566 USA WYFR in EG 2007, relig pgm, heavy QRM, p (Park 10/14)
- 15570 NETHERLANDS RN in DT 1750-1800, ID, classical mx, f (Trotto 10/14)
- 15600 LIBERIA VOA relay in EG 1600, world & US mx (Feeley 10/8) "Music Time in Africa" 1730 (Gray 10/28) "African Directions" in EG at 2220 (Parks 10/14) 0812 in Hausa/EG/FR, IS, ID, sked, pgm previews & trilingual nx rpts, f (Park)
- 17595 MOROCCO RIM in AR 1506, nx w/mention of Washington (O'Brien 11/2)
- 17620 FRANCE RFI in EG 1610-1630, Afr nx & Spotlight on Afr (Feeley 10/8, Parks 11/3)
- 17670 EGYPT R. Cairo in AR 1230\* w/nx (Green 11/5)
- 17700 EAST GERMANY RBI in EG 1345, "Give Peace a Chance", tks abt NATO (Prath 10/27)
- 17700 USSR R. Moscow NAS in EG 0000, IS, mil band mx, nx, political tlk (Park 11/6)
- 17705 NEW ZEALAND 2112 in EG, mx by Dan Fogelberg & Herb Alpert, tlks on today's holidays, p (Park 10/7) 0025-0040 in EG, nx & actualities, ID, TC (Jordan 10/12)
- 17710 ISRAEL Kol Israel in RS 1400, nx, light jamming, f (Zilmer 11/8)
- 17730 USA WINB Red Lion, Pa. in EG \*1600-1645, IS (elec piano or celeste), ID, "Rock of Ages" by choral group, sermon, more hymns, p (Jordan 10/20)
- 17740 USA VOA Greenville in AR to N Afr 2031-2135, jazz, EG lessons, nx (Dillon 10/28)
- 17752 PAKISTAN RP in Gujrati 0440, nx, ID, QRM R. Australia 17750, f (Wood 11/5)
- 17755 JAPAN R. Japan in JP \*0000-0015, IS, ID in EG, TC, nx, cmntry, f (Trotto 10/13)
- 17765 SWITZERLAND SRI in EG 1330, interview abt mental illness (Parks 10/21)
- 17765 WEST GERMANY DW in PL 1314\*, ID in PL & EG, s/off in PL, f (Trotto 11/4)
- 17765 USA AFRITS Delano to FE in EG 0032, Reagan-Mondale debate (Park 10/22)
- 17790 ECUADOR HCJB in EG 1945, "World of Science" (Green 11/4) in FR 2030, Andean mx, bad QRM (McKellar 10/14) 2130 in EG, DX pgm, into SP at 2200 (Park 10/20)
- 17790 GUM KITWR in EG 0001-0011, relig mx, letters from listeners (Takeda 11/1)
- 17790 UNITED KINGDOM BBCWS in EG 1455-1500, "Play of the Week", ID, nx (Trotto 11/4)
- 17800 ECUADOR HCJB in EG 2140, DX pgm, ex 17795, p (Park 10/8)
- 17805 USA WYFR in SP 0030-0055, inspirational mx, organ mx, ID, g (Dillon 10/23)
- 17810 ANTIGUA DW relay in GM 1959, ID in EG, into GM at 2000 (Green 11/4) also in GM 2100, classical mx (Erwin 10/20)
- 17825 JAPAN RJ in EG 0020, cultural pgm, ID (Jones 10/8) also in EG 0034 w/comments on health (Levison 10/16) in JP 0114-0120, IS, ID, f-p (Bobb 10/16) again in EG at 0215 w/"Spotlight", g (McKellar 10/17)
- 17830 UNITED ARAB EMIRATES R. Dubai in AR 0445, interview, ID, //21700 (Wood 10/24)
- 17845 VATICAN CITY VR in EG \*1430, freq & time sked, relig nx, f (Zilmer 11/9)
- 17855 ASCENSION ISLAND BBC relay in EG 1400, "Outlook to Africa", g (Zilmer 11/8)
- 17860 USSR R. Yerevan in AM 0105-0135, harp mx between segments, seemed to be all actualities abt Soviet Armenia, ID "Govorit Moskva" but not usual RM IS, //15405 and 15180, all good sigs presumably fr Petropavlovsk (Palmer 10/31)
- 17860 ANTIGUA DW in GM \*1800-1805, IS, ID incl relay location, nx, exc (Trotto 10/14)
- 17870 JAPAN RJ in SW 0440, tlk abt telescope in Hawaii, into IT 0445, nx, //15235, g (Wood 10/24)
- 17870 LIBERIA VOA relay in EG 2232-2300, Afr sce, ID, "Music Time Africa", nx, OPEC conference details (Gray 10/28, Dillon 10/21)
- 17875 CANADA RCI in FR 1935-1945, nx, wx, ID, feature on space shuttle (McKellar 10/5)
- 17884 CUBA RHC in EG 2021, discussion abt Reagan and human rights (Feeley 10/12)
- 17910 QATAR QBC in AR 1525-1550, AR mx, world nx, male vocals & drums (Dillon 10/13)
- 21473 PHILIPPINES FEBC in EG 0215, "Good morning India", DX tips in India-accented EG, religious poem, g (Wood 10/24)
- 21480 MADAGASCAR R. Netherlands relay in EG \*1427-1500, IS, ID 1430, Tom Meyer's Happy Station pgm, mx incl duelling banjos across by a flute (Enkenhus 11/4)
- 21640 BANGLADESH RB in Bengali 0915, ID, lite mx, 0928\* abruptly, g (Wood 10/16)
- 21660 ASCENSION ISLAND BBC relay in EG 0620, Radio Newsreel, //17885, g (Wood 11/5)
- 21685 FRANCE RFI in EG 1649-1653\*, Paris calling Africa, ID, g (Trotto 10/13)
- 21685 NETHERLANDS ANTILLES RN relay in AR 1802, DX pgm, //17605 (Park 10/24)
- 21695 GABON R. Japan relay in JP 1630, soccer cmntry, f, QRM: R. Canada (Wood 10/20)
- 21695 CANADA RCI in EG 1655-1700\*, nx, ID, s/off anmnts, g (Trotto 10/13)
- 21720 AUSTRALIA RA in EG 0510, Sammy Davis mx, tlk abt Asian candidate for Intl Court of Justice (Park 11/6)
- 21735 WEST GERMANY R. Liberty in RS 1310, political tlk, ID "R. Svoboda", //21745 (Prath 10/27)

\*\*\*\*\*  
 314 loggings this month for Log D section. 229 have been listed here and the rest were reported in November FRENEX. Please see last month's issue for current update. Sorry that I haven't had time to check out the unidentified listing at 15055. Maybe another member will be able to clear this one up for us next month.  
 \*\*\*\*\*

# LOG FRENDX REPORTERS

John M. Kapinos, 86 S. Quinsigamond Ave., Shrewsbury, MA 01545

Sam ALCORN, Maplewood, NJ (DX200); Brian ALEXANDER, Mechanicsburg, PA; David ALPERT, New York, NY (R71A); Kevin ATKINS, Pinson, AL (R390A); Jerry BERG, Lexington, MA; Norman BOBB, Minneapolis, MN (R600, CR2021); Charles BOLLAND, Lake Worth, FL (R70, FRG-7000); Richard CASSIDY, Logansport, IN (R1000, CR2021); Ken COBB, Portland, ME (RF4900 CR2021); Thomas DALY, Pomona, NY (FRG7700 CR2021); Richard D'ANGELO, Wyomissing, PA (R70); Richard DICKSON, Goshen, OH (DX302); Peter DILLON, Washington, DC (Zenith 300, DX400); Kurt ENKENHAUS, Silver Spring, MD (NRD515); Joe ERWIN, Arlington, VA (SPR4, ICF6800W); Jim FEELEY, Norcross, GA; Marlin FIELD, Hillsdale, MI (SX100, SPR4); Ray FORSGREN, Chippewa Falls, WI (FRG7000); Karl FORTH, Chicago, IL (HQ160, ICR70); J. Speed GRAY, Grand Rapids, MI (NRD515, R71A); Jerry GREEN, Maryville, TN (FRG 7700); Michael HAWK, Hampton, VA (ICF6800W); Ron HOWARD, Santa Barbara, CA (R71A); Billy HUNT, Durham, NC (NRD515, ICR70); Hans JOHNSON, Austin, TX (R71A); Brian JONES, Houston, TX (R70); Rufus JORDAN, Pittsburgh, PA (DX302); Harold LEVINSON, Philadelphia, PA (R70); Jerry LINEBACK, Conroe, TX (R7); Bob MCCURDY, Camp Hill, PA (RF2900); Travis MCLEMORE, Clearwater, FL; John MCKELLAR, Chico, CA (DX160); Don MOORE, Comayagua, Honduras (FRG7); Ray NIEKAMP, Minneapolis, MN (DX200); Andy O'BRIEN, Chantilly, PA (R2000); Robert PALMER, Spokane, WA (R71A); Nick PAPPAS, Orlando, FL (SPR4); Dale PARK, Honolulu, HI (ICF6700W); Charles PARKS, Houston, TX (RF3100); Sheryl PASZKIEWICZ, Manitowoc, WI (DX400, DX302); J. Gary PATE, Baltimore, MD (R70); Alan PLOTNICK, Hamden, CT (R71A); Bill PLUM, Flemington, NJ; John PRATH, Ft. Lauderdale, FL (ICR71A); Ron PURDUE, Byron, MN; Steve REINSTEIN, Mirimar, FL (R70); Christos RIGAS, Chicago, IL (R2000); Mitch SAMS, Wichita, KS (FRG7); Bryan SHARPE, Castro Valley, CA (DX302); David SWARINGEN, Huntersville, NC (R70); Ron TROTTO, St. Cloud, FL (CR2021); George VADINO, Bellevue, WA (RF4800); Dave VALKO, Dunlo, PA (R388, FRG7); John WILKINS, Wheat Ridge, CO (R1000, CR2021); Dr. Richard WOOD, Hilo, HI (R1000); Robert WOODS, Front Royal, VA (RF4900);

Well, if the Credits Page does indeed appear, give all of the credit to the USPS Express Mail, certainly none to yours truly, who managed to foul up the deadline. Again a nice turnout as the DX season is in full swing. All contributions are most welcome, whether it's 1 or 100 logs. A favor, please, kindly mark envelopes "Log Reports", as it makes my job a bit easier.

\*\*\*\*\*  
\*AWARDS NEWS\*  
\*\*\*\*\*

Not much news this month. As of right now, all applications received have been process and the certificates sent out. To anyone who has sent in an application in the past year and has not received their Award, please let me know right away and we'll clear the matter up. In answer to a couple of questions: The "Date" should indicated the date the station was received, NOT the date the QSL arrived. Also, the verification signer is no longer required, as most are illegible in the first place. And, in closing, a Merry Christmas and Happy Chanukah to all.

*Best,  
Log*

-DX SPECIAL-

ABC TALKRADIO/RAY BRIEM SHOW

SATURDAY, DECEMBER 15, 1984--0806 utc

DXING GOES NATIONWIDE! JOIN RAY AND HIS IN-STUDIO GUESTS, DR. RICHARD WOOD AND STEWART MACKENZIE AS WE DIVULGE THE VARIOUS WORKINGS OF OUR STRANGE AND WONDROUS HOBBY! WE WANT YOU TO CALL IN AND PARTICIPATE--DIAL (800)423-8255 TO SPEAK TO DR. WOOD AND MR. MACKENZIE (IN CALIFORNIA CALL 800-262-8255). WE ALSO WILL FEATURE LIVE "PHONERS" WITH ARTHUR CUSHEN IN INVERCARGILL, NEW ZEALAND; AND WITH GLENN HAUSER (OF WRNO) FROM FORT LAUDERDALE!

-AS THE SHOW'S PRODUCER, I WELCOME ANY LITERATURE OR SUGGESTIONS, ETC. , WHICH MAY MAKE POSITIVE CONTRIBUTIONS TO THE PROGRAM. PLZ SEND TO: GREG HARDISON

C/O KABC  
3321 S. LACIENEGA BLVD.  
LOS ANGELES, CA 90016

WHERE TO TUNE IN YOUR (OR ANY) AREA: (SHOW STARTS AT 0806 UTC//0306 EST)	(#=TAPE DELAY-CHECK FOR TIMES) (*=BROADCAST TILL 0500 EST)
KABC LOS ANGELES, CA 790kHz	WQBK ALBANY, NY 1300kHz
KGNR SACRAMENTO, CA 1320kHz	WSLI JACKSON, MISS. 930kHz
KLCL LAKE CHARLES, LA 1470kHz	WTKN PITTSBURGH, PA 970kHz
KLIQ PORTLAND, OR 1290kHz	WTTP NATICK, MA 1060kHz
KMUS MUSKOGEE, OK 1380kHz	WVNF ALPHARETTA, GA 1400kHz
KOH RENO, NV 630kHz	#KGU HONOLULU, HI 760kHz
*KPRC HOUSTON, TX 950kHz	#KRIG ODESSA, TX 950kHz
KPSI PALM SPRINGS, CA 1450kHz	#KURV EDINBURG, TX 710kHz
KTMS SANTA BARBARA, CA 1250kHz	
KUHL SANTA MARIA, CA 1440kHz	
KXOK ST. LOUIS, MO 630kHz	
*KZIA-FM ALBUQUERQUE, NM 101.7MHZ	
KZJO SALT LAKE CITY, UT 630kHz	
WABC NEW YORK, NY 770kHz	
WBBF ROCHESTER, NY 950kHz	
*WBBW YOUNGSTOWN, OH 1240kHz	
WCBM BALTIMORE, MD 680kHz	
WCVL CRAWFORDSVILLE, IN 1550kHz	
WEAN PROVIDENCE, RI 790kHz	
WERC BIRMINGHAM, AL 960kHz	
WGL FT. WAYNE, IN 1250kHz	
WHBQ MEMPHIS, TN 560kHz	
WIIN ATLANTIC CITY, NJ 1450kHz	
WKHM JACKSON, MICHIGAN 970kHz	
WMER PORTLAND, ME 1440kHz	
WNIS NORFOLK-PORTSMOUTH, VA 1350kHz	
WOKV JACKSONVILLE, FL 600kHz	
WPQZ CLARKSBURG, WV 1400kHz	

-THIS SEGMENT OF THE SHOW SHOULD LAST AT LEAST TWO HOURS; THE MORE CALLS WE RECEIVE, THE LONGER THE SEGMENT WILL CONTINUE--SO DUST OFF YOUR TELEPHONES, AND LET US HEAR FROM YOU DXERS!!!!

**HAP BID ITEMS:** ITEM #160: RTE Radio 2 (Ireland) sticker (3.5x6") m/c. #161: RTE Radio 2 T-Shirt (M) m/c-nice. #162: RTE Radio 2 T-Shirt (L) m/c. #163: RTE Radio 2 decal (over 5" long!!!) white, red, orange. #164: RTE Radio 2 paper folder (8.5x13") m/c-nice. #165: RTE Radio 2 large plastic litter bag, m/c. #166: KEYH sticker in Spanish (3x13") m/c. #167: KLAT sticker in Spanish (3x12") m/c. #168: KLOL "Rock" sticker (3.5x12") m/c. #169: KFRD sticker (4x7.5") m/c-nice. #170: Radio Panda Milano (Italy) sticker (1.5x9") m/c. #171: RTE Radio 2 sticker (3x7") m/c. #172: WOTOS plastic ID card (2x3.5") m/c. #173: QOSB (Pirate) QSL card and letter QSL, m/c. #174: KBPS 5 different studio photos-oldest. #175: Caribbean Beacon (Antigua) sticker (3x11") m/c-beautiful. #176: Radio Vigo (Spain) sticker (2x8") m/c. #177: Radio Vigo match book, m/c. #178: Radio Vigo cloth pennant 1959 era, m/c-very nice. #179: CPSL/CJSL sticker (4x13.5") red, blue. #180: CJWW sticker (3x8") blue, white. #181: CBC-Halifax QSL card (3.5x5.5") blue, B&W. #182: CBC sticker (3"cir) m/c-nice. #183: CKBS-TV sticker (2x6") m/c. #184: KIKR sticker (3x12") orange, green. #185: WTAW sticker (3x11.5") m/c. #186: KIOX sticker (3x11.5") blue, white. #187: KVLL reflective "Dallas Cowboys" sticker (3.5x4.5") m/c. #188: KPXE reflective "Dallas Cowboys" sticker (3.5x4.5") m/c. #189: KZEU sticker (4x8") m/c-beautiful. #190: KWDX/KKAS sticker (3x12") black, red, gold. #191: KORA sticker (4x7") blue, B&W. #192: KSAM sticker (6"cir) m/c-georgous. #193: KNAL sticker (3x11.5") m/c. #194: CKSW pen, blue, white. #195: CKSW paper folder (9x12") m/c. #196: RNE Radio 4 (Spain) sticker (2.5x4.5") black, red, yellow. #197: Catalunya TV-3 (Spain) sticker m/c-very nice. #198: Deutsche Welle cloth pennant with address (6x13.5") blue, white. #199: Radio Veritas (Philippines) paper pennant (3x5.5") black, red, blue. #200: KLVL pencil, B&W. #201: CKRD pen, black, blue, yellow-nice. #202: Radio Sweden cloth pennant (4x9") blue, yellow. #203: WQBS (Puerto Rico) decal (2x7") red, white. #204: Signal Radio (UK) decal (2.5x9") m/c. #205: CJBK sticker (4x6") m/c. #206: Radio Nacional de Venezuela decal (3"cir) red, white, blue-nice. #207: Radio Popolare (Italy) reflective sticker (3.5"cir) m/c. #208: DLF (FRG) sticker (6"cir) m/c-beautiful. #209: Radio Earth QSL card (3x5") B&W. #210: WBSB T-Shirt (XL) yellow, blue. #211: WKQQ hat, B&W-nice. #212: KLOS "Rock" T-Shirt (S) m/c. #213: Telecom France cloth bag, red, white, blue-useful. #214: Radio Genova (Italy) sticker (2x5") yellow, B&W. #215: Radio Italia sticker (4"cir) green, red, white. #216: Club DX Quebecois sticker (3"cir) blue, white. #217: KTAC "Seattle Sounders" poster, m/c-large. #218: WRIF T-Shirt (M) with black sleeves. #219: RFI (France) hat, red, white, blue. #220: KIFM T-Shirt (S) blue, black. #221: WRCK T-Shirt (M) blue, white, yellow. #222: DC-101 T-Shirt (M) m/c-nice. #223: Radio Sweden poster (12x17") m/c. #224: CJSW poster (17x20") red, B&W. #225: KMET large wall poster, m/c-beautiful. #226: WLMU sticker (4x14") red, orange, white. #227: Viking Radio (UK) decal (3x20") m/c. #228: CPTP sticker (3x9") m/c. #229: RFI plastic carrying bag (15x17") red, white, blue. #230: Radio Norway sticker (3x5") m/c. #231: RCT/CBC 11 different QSL cards. #232: KQUA "Choice" metal badge (2"cir) m/c. #233: CKUA "Access" metal badge (1.5"cir) orange, B&W. #234: WJGS plastic key chain, blue, white. #235: Radio Hallam (UK) metal badge (2"cir) m/c. #236: KLOK station balloon, m/c. #237: Radio Nacional de Venezuela cloth pennant (6x11") m/c-beautiful. #238: Voice of Turkey cloth pennant (4.5x8") m/c. #239: Radio Bucharest cloth pennant (4.5x7") white, orange. #240: Radio Italia sticker (3x4") m/c. #241: Radio Polonia pin, m/c. #242: Radio Northland (NZ) sticker (3x6") m/c. #243: Radio Earth sticker (3x12") B&W. #244: ADDX (FRG) sticker (4"cir) blue, gold. #245: Radio Forth (Scotland) coaster (4x4") orange, B&W. #246: Radio Peking "Mountain Village" paper pennant (5.5x10.5") m/c. #247: WHGR metal badge (1"cir) green, white. #248: WLLZ metal badge (1"cir) B&W. #249: WLLZ metal badge (1"cir) blue, white. #250: MTV sticker (4x4") m/c. #251: ORF sticker in French (5"cir) red, B&W. #252: KUHF sticker (3x7") red, white. #253: CFCR sticker (4x5") m/c. #254: Radio Bristol (UK) sticker (5"cir) red, white. #255: KPDX sticker (3x9") m/c. #256: WUVA sticker (3x11.5") red, B&W. #257: Radio Hallam sticker (1x12") orange, B&W. #258: WCAD (Puerto Rico) sticker (3x6") m/c. #259: KXYZ sticker in Spanish (3.5x11") m/c-nice. #260: Radio Nacional do Brasil sticker (3.5"cir) m/c. #261: Radio Moray Firth (Scotland) decal (over 4" long!) green, white. #262: Radio Clwyd (Wales) decal (5"cir) m/c. #263: Northsound Radio (UK) decal (3x13") m/c. #264: Radio Devon decal (3x9") m/c. #265: HCJR sticker (3x8") B&W-nice. #266: Radio RSA sticker (3.5x5.5") yellow, black. #267: GFCN metal badge (1.5x3") red, B&W. #268: Radio Manchester (UK) cloth covered book, calendar (3x6") m/c. #269: Radio Faxe (Italy) reflective sticker (2x8") orange, gold. #270: BBC Radio One (UK) match book, m/c. #271: Mercia Sound (UK) key chain, red, white. #272: KRYT metal badge (1.5"cir) red, white, blue. #273: Viking Radio newspaper, very nice. #274: RNE (Spain) soccer poster-large, m/c. #275: Viking Radio paper hat, m/c-sharp looking. #276: Mercia Sound decal (3x15") m/c. #277: Radio Earth pen, red, gold. #278: WWHI (Virgin Islands) sticker (3.5x5") blue, white. #279: Radio Evangile (Monaco) decal (2.5x3") red, white... Hope there is something for you in this selection... Sam. ADDRESS: Please send your bids and orders for direct sale items to: Sam Barto, 47 Prospect Place, Bristol, CT. 06010 USA... Minimum order \$3.00 from overseas... please!

**HAP DIRECT SALE ITEMS:** The following stickers/decals are \$.25 each or any 5 for \$1.00. If your order exceeds \$5.00 you may select 7 for each \$1.00! New since last issue: BBC-WS, Radio Budapest (red) (blue) (small), KVLU, WBEH, LZB, Radio Break, CJOB (large) (small), KTAM, Radio Kuwait, CHNC, WCAU (large) (small), KKNX, WWSW, Capital Milano, KETX, KTXN, RTE Radio 2, CHAB, CJWW, KHUN (large) (small), KJCH, KTFX, KDVE, KOGT, WGY, KOTI, CJME, CKND, CKOM (large) (small), RMI-FM, ARD-ZDF, Berlin Radio, Canale 5, Telecom-83, KGB, Sea Gull Radio, CFUN, RNE, Polskie Radio, Radio Highlands, Radio London, City-TV, RMI, RBI-DX Club, 4XD, Radio Caroline (black) (white), ZCH, Radio El Mundo, KAIM, Radio West, RFI (large) (blue) (red) (cir), Radio 270, WQFM, KDKD, WNVN, WINS, Signal Radio, Radio Bucharest, Radio Superstar, RTE 2, RBI (large) (gold) (silver), Telecom-Genève, DC-101, 101, Radio Newcastle, Radio Nottingham, BBC Radio 1, Radio Polonia, KBOI (large) (small), KWK, KBBX, CFMO, WMR, WDAE, Radio Bristol, Radio Rhema, KOMA, KPNW, Radio Forth, Radio Victory, CFRA (red) (orange), KPLU, WPLJ, K-94, WRIF, WDR (rock), Radio Orkney, KRQR, Radio Maddalena, GDXC, Radio Freedom, Amica Radio, VOFC (square) (pennant), Radio Kelly, Radio Musichallicity, WJBV, BBC Radio One, Radio 210 (large) (small) KROY (large) (small), WMMS, KQWR, WEMP, Disco-99, MTV, KZZB, 97-Rock,

# NORTH AMERICAN SHORTWAVE ASSOCIATION

45 Wildflower Road  
Levittown, Pennsylvania 19057

FIRST-CLASS MAIL  
U.S. POSTAGE  
PAID  
Levittown, Pa.  
Permit No. 319

## FIRST CLASS MAIL

# NASWA "UNITY AND FRIENDSHIP"

### PUBLISHES FRENDEX MONTHLY

#### NASWA MEMBERSHIP FEES:

First Class North America.....	\$16
Overseas, Surface Mail.....	\$16
Airmail to Central America, Caribbean, South America, Europe.....	\$25
Airmail to Asia, Africa, Pacific.....	\$28

All remittances must be in U.S. funds and mailed to NASWA,

45 Wildflower Road, Levittown, PA 19057

Update: Besides FRENDEX, NASWA also publishes UPDATE...a mid month newsletter with the very latest DX news while it's still news. (UPDATE also appears in each issue of FRENDEX). It is only available to NASWA members.

"UPDATE" SUBSCRIPTION RATES PER YEAR:

North America (First Class).....	\$4.00
Overseas (Airmail).....	\$6.00
Sample copies of FRENDEX and UPDATE are available for \$1.00 in N.A.	
Overseas.....	\$2.00

EXECUTIVE DIRECTOR & PUBLISHER - Bill Oliver, 45 Wildflower Road,  
Levittown, PA 19057

SHORTWAVE CENTER - John C. Herkimer, 3233 East Ave., Caledonia, NY 14423

LISTENERS' NOTEBOOK - Glenn Hauser, Box 490756, Ft. Lauderdale, FL 33349

OSL REPORT - Sam Barto, 47 Prospect Place, Bristol, CT. 06010

UPDATE EDITOR - Tom Alleman 636 E. 74th Terrace, Kansas City, MO. 64131

DISTRIBUTING EDITOR - John M. Kapinos, 86 South Quinsigamond Avenue, Shrewsbury, MA 01545

LOG REPORT (A) - Mike Nikolic, 2137 W. Farwell Ave., Chicago, IL. 60645

LOG REPORT (B) - Jerry Berg, 38 Eastern Avenue, Lexington, MA 02173

LOG REPORT (C) - David L. Walcutt, 211 West 56th, Apt. 36 F, New York, NY 10019

LOG REPORT (D) - Wallace C. Treibel, 357 N.E. 149 St., Seattle, WA 98155

SCOREBOARD - Jerry Lineback, 115 Wroxtton, Conroe, TX 77304

AWARDS CHAIRMAN - John M. Kapinos, 86 S. Quinsigamond Ave. Shrewsbury, MA 01545.

COUNTRY LIST CHAIRMAN - Don Jensen, 5204 70th St., Kenosha, WI 53140

U.K. REPRESENTATIVE - Alan Thompson, 15 Ens Ave., Neath, W. Glamorgan,

Great Britain, SA 113AD

