

FRENDX



H
A
P
P
Y



H
O
L
I
D
A
Y
S



NASWA
FRENDX



NASWA

HEADQUARTERS REPORT

NORTH AMERICAN SHORT WAVE ASSOCIATION

46 WILDFLOWER ROAD, LEVITTOWN, PA. 19067

SPECIAL ATTENTION NASWA MEMBERS

NASWA owns two Pitney Bowes Model 5830 Postage Machines. One machine is at club HQ in Levittown, PA and the other has been used in the Business Office in Liberty, IN. Because of the transfer of most of the mail activity to Levittown, we find we no longer need the second machine.

The machine in Liberty was purchased new from Pitney Bowes in April, 1979 for \$567.00. This does not include the Postage Meter which is also needed to form the complete unit. The meter unit has to be leased on a quarterly basis since they are never sold outright. The lease rate is determined by the users mail volume. Meters are available for lease through any of the Pitney Bowes Sales Offices located in principal cities throughout the country.

We are offering the machine unit to NASWA's membership first at a cash price of \$250.00 including shipping. We can guarantee the machine to be in first class condition since it has been covered by service and maintenance agreements from date of purchase. For any small business owner who would like the convenience and advantages of using metered mail, this is an excellent opportunity to go in that direction at a modest price. Any NASWA member who might be interested in knowing more about the machine or what other costs might be involved can drop a note to M.R. Leonhardt, NASWA's Business Manager, at P.O. Box 13, Liberty, IN 47353 giving your phone number and a convenient time to call and he will contact you to discuss the matter further and answer any questions about the machine.

SHORTWAVE NETWORKS BULLETIN BOARD

The new Shortwave Networks Bulletin Board will be on the air by Nov. 1, 1983. Membership will be open to all, but the board will give preference to messages of interest to SWL's and hams. Topics will include everything from 10 kHz to 10 GHz. At the present time the board will be considered on an experimental basis and there will be no membership fees. The operators wish to evaluate the demand for such a board, and the mix between local calls of general interest and calls from anywhere that deal with the general topic of radio. They welcome your participation and suggestions. Temporary hours will be from 11:00 P.M. Central Time until about 9:00 A.M. the following morning. All that is necessary is a 300 Baud Modem capable of operating in Full Duplex. If there is no answer during these hours, please be patient and try again. The number is (701) 746-4814. For further information, please contact Ken Reiss, 2605 South 17th Street, Grand Forks, ND 58201 or call the number given.

ASIAN AREA TAPES AVAILABLE

A letter from the Japanese Association of DXers states that Toshiyuki Watanabe, a JADX member, has compiled two tapes (one 90 minute and one 60 minute cassette) of Asian area stations including Burma, Kampuchea, Laos, Thai, Vietnam, and some clandestine stations. The tapes also include many local stations and languages like Meo, Lao Soung, etc. The price for both cassettes is 2400 Yen Airmail and 2000 Yen Surface Mail. Payment should be by International Money Order (available at most Post Offices) and the address is Mr. Toshiyuke Watanabe, 24-26 3-chome Hiyoshidai, Yahatanishi-ku, Kitakyushu, 807 Japan. Payment may be made in US\$'s, but the price of \$13.00 Airmail and \$11.00 Surface Mail does not take into consideration the floating exchange rate or exchange charges.



Shortwave Center

Editor: John C. Herkimer, 3233 East Avenue, Caledonia, NY 14423

Verifying Chinese Regional Stations



新疆人民广播电台
XINJIANG HOKL RADIYO ISTANSISI

by Jerry Berg, 38 Eastern Avenue, Lexington, Massachusetts 02173

To the dismay of many DXers, it was virtually impossible for many years to verify stations other than Radio Peking on the Chinese mainland. This situation has changed, however, thanks to the work of Gerry L. Dexter and others, and it is now possible to verify transmissions from the Chinese regional "People's Broadcasting Stations". The simplest avenue to this objective is to send reports on these stations to Radio Peking, which has been willing to respond with full-data, English-language QSL-cards bearing the "signature" of the regional station itself, e.g. "Nei Menggu People's Broadcasting Station" (though not the actual city where the station is located). Most DXers would probably agree, however, that Radio Peking is not able to actually check the correctness of such reports, but issues the verifications as a courtesy to DXers.

A more satisfying method of verifying the regional stations is by way of reporting direct to those stations. The experience of the last four years indicates that many of the regionals will now verify direct. To examine this development more closely, in 1981 I distributed a questionnaire to a small number of DXers who were known or thought to have received direct verifications from Chinese stations. A total of eleven DXers participated in the survey, of whom six had received a total of 26 such direct verifications. The survey was intended to be exploratory, not comprehensive. Certainly these are not the only DXers who have verified Chinese stations directly. On the other hand, the data supplied by the survey participants was sufficiently consistent to suggest the general applicability of the findings offered below. This article contains the results of the 1981 survey, updated based on results since then. (Little appears to have changed since 1981.)

Which stations will verify direct?

The following People's Broadcasting Stations (PBS) have verified direct to one or more of the DXers surveyed:

Hunan PBS, Changsha
Nei Menggu PBS, Hohhot
Qinghai PBS, Xining
Yunnan PBS, Kunming
Xinjiang PBS, Urumqi
Gansu PBS, Langzhou
Fujian PBS, Fuzhou
Xizang PBS, Lhasa
Guangxi PBS, Nanning
Hubei PBS, Wuhan
Shaanxi PBS, Xian

广播收听证

亲爱的朋友:

兹证明您十二月廿一日的收听报告, 频率
6260 千周, 符合本台节目。欢迎继续告诉
我们收听情况。



QINGHAI PBS

It has also been reported in club bulletins that Liaoning PBS, Shenyang; Zhejiang PBS, Hangzhou; and Shandong PBS, Jinan (MW) have verified direct to other DXers. Given this rather large number of stations that have verified direct, it is clear that the policy to verify direct is one that has been made by Chinese broadcasting authorities on a countrywide basis and is not simply idiosyncratic with a few stations.

The following stations have not yet responded to reports sent by the DXers surveyed nor have I seen reports of direct QSLs from these stations (or others) in the hobby press:

- Heilongjiang PBS, Haerbin and Hailaer
- People's Liberation Army Radio Station
- Sichuan PBS, Chengdu
- Jiangxi PBS, Nanchang

Heilongjiang PBS and the PLA Radio Station (Fujian Front Station) in particular have been the QSL targets of several of the survey participants, but without results (although I have seen one report of a PLA QSL received by way of Fujian PBS). Heilongjiang PBS is of special significance because it, along with Xizang PBS, represent stations in locations (Manchuria and Tibet respectively) that are considered separate radio "countries" in some lists, such as the NASWA country list. My guess is that the above listed four stations, with the possible exception of the PLA station to which special military considerations may apply, will join the ranks of the verifiers eventually. Indeed, a few isolated verifications were received from the PLA station a number of years ago, long before the PBS stations began verifying.

Time signal station BPM has also responded to many reports with its own full-data QSL card.

Types of QSLs: The PBS QSL is often in the form of a printed white card, 4" by 6", containing a Chinese verification statement, roughly translated as follows: "Verification of Reception. Dear friend: This is to prove that the station you received on _____ (date) on _____ kHz is our station. We welcome your further comments on your reception of our station." The date and frequency are filled in by hand. At the bottom of the card the station name is either pre-printed, or the "PBS" is pre-printed and the station identifier is added by hand. Some of the cards have black and white pictures on the reverse side, and some do not.

There is some further variation in the style of the verifications, however. Some stations send typed or handwritten personal letters along with or in place of the card. Sometimes the letters are in English, and sometimes in Chinese. One station typed the verification statement contained above on a small square of paper. Another translated the verification statement into English and wrote it on the back of a color postcard. Sometimes the letters and cards bear a red station handstamp consisting of a circle with a star in the center and the station name around the perimeter. One station sent a folding card.

The stations often enclose small souvenirs with the verifications such as picture postcards, Chinese program schedules, cancelled stamps and small Chinese pocket calendars.

Method of reporting: Most of the DXers surveyed followed the more or less traditional method for reporting to the stations. Reports were in English and usually contained no return postage. One DXer who has had good luck in obtaining direct Chinese verifications followed the practice of sending taped reports, by registered airmail, and including an IRC with each. Whether his success is related to this reporting technique or plain old perseverance is unknown.

明信片 POST CARD 广播收听证 RUC 100001	日期 DATE 8-10
亲爱的朋友 茲証明您于 月 日的 收听报告, 频率 千周, 符合本台节目, 未经过播音价 我们收打情况。 云南人民广播电台 年 月 日	Dear Friends It is to certify that your recep- tion report on the _____ (Date) _____ (Month), _____ KHz, and the reception report corresponds With Our station log Welcome your report the con- dition of the reception to us above. Yunnan People's Broadcasting Station

YUNNAN PBS

Often enclosed with reports were postcards, cancelled stamps, rig photos, etc. - the usual things one sends with reports. I like to send newspaper articles about China (as long as they are non-political) and constructive in nature). I have also sent advertising brochures from a department store that was featuring a special fair of goods from China. Another successful DXer cautioned against sending too many souvenirs, however, as he felt that this created some risk that the report and its main purpose - obtaining a QSL - might get overlooked at the station and that the QSL itself might be forgotten in the stations's reply.

Reports were addressed to the station using just the city and province, e.g. "Qinghai People's Broadcasting Station, Xining, Qinghai Province, People's Republic of China". This is apparently enough to get the report to its destination. Some of the replies contain return addresses that are themselves no more detailed than that. Others, however, bear what appear to be return addresses containing both Chinese characters and Arabic numerals. As far as I know, however, these addresses have not been translated into the Chinese Phonetic Alphabet, as they would have to be in order to be useable.

One of the most troublesome aspects of reporting to Chinese stations is providing good program details. Unfortunately, unless he is schooled in Chinese, the DXer who wants to provide verifiable details is reduced to counting time pips or hoping to catch a western song that he might know or a Chinese drama (which is generally identifiable as such even if one knows no Chinese). It would seem to be a big help to report one of the English language lessons that are broadcast over some of the Chinese regional stations (though at my location, where reception of Chinese regionals is only fair at best, this is not possible at the times the lessons are broadcast). The difficulty in providing solid program details and the inevitable boredom that accompanies listening to programming about which you have not a clue has probably worked to limit the number of reports sent direct to Chinese regional stations by DXers.

Response time: It is difficult to generalize as to response times.

Some of the first direct QSLs were received one or two years after the reports were sent. More recently, however, it appears that when responses are forthcoming without the need for a follow-up, they are received within two to four months of the report. There are exceptions, however, and it seems not unusual for a report, not followed-up, to take more than four months for a reply. My advice is to wait three months and then send a follow-up. As with stations reporting generally, follow-ups do make a difference. With some Chinese stations a follow-up will yield two separate verifications, one for the original report and one for the follow-up, even if the second report is just a copy of the former.

POST CARD	
<p>Your first reception report is correct, and we have sent you a verification before. And we send you an address for the second letter. Thank you for your reports, and hope you send us more.</p> <p>Sincerely, Radio Fujian</p> <p>1982 China Post</p>	<p>Mr. Jerry Wong</p> <p>_____</p> <p>_____</p> <p style="text-align: right;">FUJIAN PBS</p>

The wait is worth it, however. To those of us who know a little about China, these handwritten replies in brownish envelopes bearing exotic looking Chinese characters and attractive Chinese stamps are among the most unique that a DXer will receive. Hopefully, the stations will continue to respond. My guess is that that will depend more on international political developments than on factors over which shortwave hobbyists have any control, however.

A recent letter from Andy Robins explains in part the mysterious disappearance of "Contact". As is so often the case these days, support was down--only two submissions, in fact. So, Andy offers an alternative: Andy will suggest a topic for comment each month and the response, if any, will appear in the following issue. Fair enough? Here goes: "The U.S.-led invasion of Grenada provided a golden opportunity for shortwave listeners to follow events as they happened. What did you hear, and what did you think about it? Emphasis here is on SWBC, but monitoring of ARO and military HF traffic will be considered if compelling and relevant."



LET'S SHOW ANDY SOME SUPPORT!! Your comments to 2850 Cleveland, Apt. 318, St. Joseph, MI 49085



Editor: James G. Herkimer, 3255 South Drive, Caledonia, NY 14423

More On Loop Antennas

At the conclusion of last month's column, an alternative method of coupling the loop to the receiver (link coupling) was described. There will be somewhat less gain using this method than by using a preamp and direct-coupling, but generally most receivers have more than enough gain at tropical band frequencies to compensate for this loss. Some have found reduced tank loading and therefore increased signal transfer on a spiral loop by placing the coupling link on the inside of the tank winding. Gain may be further increased by using several turns at this point as opposed to a single winding, so some experimenting is in order. Additionally, the spiral loop has a lower distributed capacitance and therefore will provide greater frequency coverage with a single section 365 pF variable capacitor. With the addition of a few extra turns on the tank winding it should be relatively easy to provide 120 meter coverage as well as 90 and 60 meters with a spiral loop.

To clear up any confusion on the two types of loops, the spiral loop has its windings in the same plane as the frame, with each consecutive turn becoming smaller as you wind towards the center. This allows a spiral loop to be mounted flat on a wall, but this will limit the loop to a fixed direction. A box loop has its windings around the outside of the loop frame, with each turn exactly the same in length. Frequency coverage for both loops is determined by the diameter of the windings (size of the frame), the number of turns, and spacing between turns. The larger the loop's diameter, the fewer the number of turns required, and the greater the spacing between turns. As the diameter becomes smaller, more turns are needed, with less spacing between turns.

There is some controversy in regards to nulling effectiveness and accurate direct finding when using loops at shortwave frequencies. It is possible to obtain satisfactory nulls on the tropical bands on some stations, however, depending upon the path of the station to be nulled in relation to the desired station, and their arrival angles. One method to increase nulling effectiveness is to make the loop tiltable. This is accomplished by modification of the loop's supporting structure to provide a fork in which the coil frame rests, and tension is made on the fork via a wing nut once the desired pitch is reached. Slight movement of the loop (left and right) while tilting should reveal a position where nulling is dramatically increased. This position is very touchy and any slight movement out of this position will lose the null. The position on the loop's supporting structure where the coil frame rests will have a center of gravity several inches below the center of the windings. This point is somewhat critical, as we do not want the tilting function to be awkward.

A second method to increase nulling capability is to use another antenna to deliberately alter the response pattern of the loop. A loop normally has a figure-8 pattern, which can become one-sided through the addition of a second current into the system. The second antenna used to provide the necessary phase shift can be just about any type at the DXer's disposal, however most people have some kind of a random wire. A variable wave-trap is used, consisting of a coil covering the desired frequency range (90 and 60 meters) and a variable capacitor. The slug on the coil is adjusted to provide a "dip" at any point of the desired frequency range with the variable capacitor. A toggle switch is needed to disable the random wire and wave trap when adjusting the loop.

The random wire may produce a greater current than the link-coupled box loop even after a "dip" is achieved, and it may be advantageous to include a small pot (5 K) to reduce the level further. This pot should be located between the random wire input and the variable wave-trap.

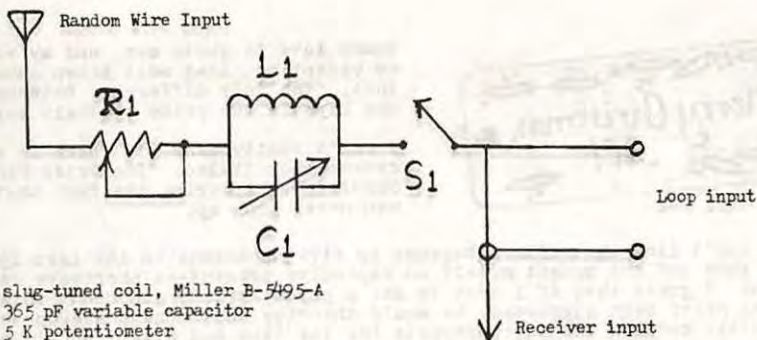

The slug-tuned coil is available from Circuit Specialists, Inc., P.O. Box 3047, Scottsdale, AZ 85257.

Random wires used by members will probably vary widely, from a length of wire hastily tossed on the floor to more elaborate outdoor installations. If satisfactory nulls do not occur with this circuit, you might try placing the coil and variable capacitor in series:

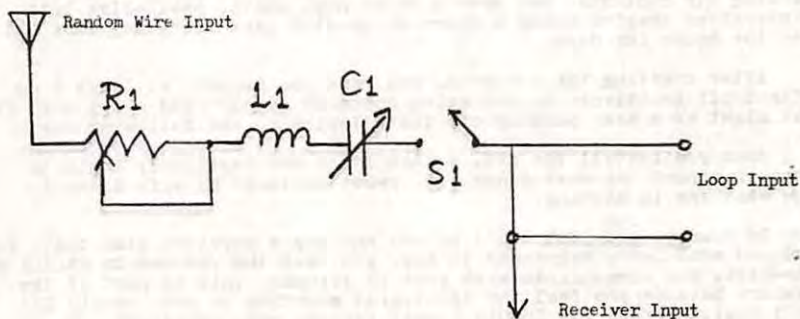

There are a few shortcomings to this relatively simple circuit. First, with S1 open (Off) C1 will still affect the loop tuning. Second, use of a single inductor will limit nulling ability with some random wires. An alternative provided by Mark Connelly of Billerica, MA is to use a switchable inductance scheme, similar to that used by Ed Shaw in his "Indoors Whipperoo" (described in [DXing According to NASWA](#)). Mark, who is a member of the National Radio Club, and International Radio Club of America, has probably written more on the subject of phasing systems than anyone, and recommends that one side of each inductor (in the switchable inductance scheme) and the rotor side of the variable capacitor be grounded. (More on this next time.)

A couple of interesting items in the mail: The R-390 Newsletter has provided considerable information on restoration, modification, and parts sources for the R-390 and R-398 series of receivers. This newsletter is being expanded to cover all tube receivers, called the "Hollow-State Newsletter". All inquiries, subscriptions, and back issue requests should be sent to Chris Hansen, P.O. Box 1226 Madison Square Station, New York, NY 10159. All editorial material should be sent to: Skip Arey, P.O. Box 421, Mount Holly, NJ 08060.

Galaxy Electronics, Box 1202, 67 Eber Ave., Akron, Ohio 44309 sends a comprehensive catalog of shortwave and scanner equipment, including Sony, Panasonic, Kenwood, and Yaesu receivers.

Once again I would like to say thanks for the fine letters received here, and I wish everyone a pleasant holiday season and a Happy New Year. 73-*Jim*

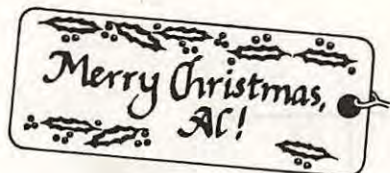

Women love to quote men, and my wife is no exception, that well known observation that, "The only difference between men and boys is the price of their toys".

I can't really deny it. There is also a recent book titled, "The Peter Pan Syndrome", exploring the fact that some men never grow up.

I can't deny that either because on five occasions in the last 15 years I have gone out and bought myself an expensive present--a shortwave radio receiver. I guess that if I went to see a psychiatrist, and don't think that has never been suggested, he would theorize that I have a deep-seated inferiority complex and to compensate for the love and attention I'm not getting, I shower love upon myself with expensive gifts.

To hell with the psychiatrist. I just know that one of the big thrills in my life is bringing home, or receiving from UPS, a receiver and opening it up. And yes, I know I wrote a column in FRENEX awhile back taking to task these hobbyists who are always buying new equipment. You didn't really think I meant it, did you?

I love opening the box, removing the synthetic insulation and checking the contents. But aren't those new, small, shell-like bits of styrofoam they're using a chore to handle? Last time they were all over the house for days.

After checking the contents, you read the manual. At least I do. I fight off impatience to get going and make myself read every word first. That might even mean putting off installation to the following day.

Then you install the set, switch it on and cautiously begin to maneuver around the wave bands. Oh, sweet ecstasy! My wife doesn't know what she is missing.

Of course, you just don't go out and buy a receiver like that. You find out what Larry Magne has to say, you read the reviews in FRENEX and elsewhere, you communicate with your DX friends. This is part of the pleasure because you feel the excitement mounting in you. Should I? Can I really afford it? Should I wait for the next receiver?

No, by gum, I'm going to do it now!

The first irresistible impulse to buy a receiver came over me in 1968. I had been teaching a journalism course at a nearby college and I had some spending money. I wouldn't ordinarily have had. I saw a Radio Shack ad for a DX-150. I believe it was \$119.95 then.

Visions of my long ago teenage era came into my mind. I had been a MW DXer of sorts. That might be fun again but the main appeal was that I could listen to news broadcasts from around the world.

Suddenly, there I was at Radio Shack buying the set and bringing home my first carton to unpack. I went ga-ga when I saw all the dials and the shiny chrome. I was hooked and soon I was becoming a member of NASWA, corresponding with DXers and really getting into the hobby.

The DX-150 served me well, bringing me in over 100 countries and Kenya, on 4915 kHz, the last night I had the set, but I began to realize there were better receivers.

In January 1970 I was in Hartford and on the way back stopped in at Hatry's, a big amateur radio store. Did they have a second hand Hammarlund HQ-180-A? They did; it was being overhauled at a repair shop two miles away where I could see it if desired. I did and bought it for \$200 with a \$25 trade-in on the DX-150.

There was no box to open this time but a manual that required close reading. Soon I was in business. A great receiver!



But I got itchy again. In November, 1971, I stopped in at Hatry's, saw a barely used SPR-4 on the counter for \$400 and before I knew it I had gotten out my Master Charge card and was the owner of a new receiver. I sold the HQ to another DXer eventually.

No box again to open but loads of excitement learning how to operate the new marvel.

I fought off buying impulses for three years but was seduced in 1974 by the Barlow-Wadley which I convinced myself I needed as a second, portable receiver. Another great carton to open!

A year later I tired of the Barlow-Wadley and sold it off. I kept out of the buying market until July 1976 when I had a couple of breakdowns with the SPR-4. While it was at the factory I plunged for the new Yaesu FRG-7 at Gilfer's. Again, I was ecstatically delving into a new carton.

The SPR-4 was sold in 1979 and for four years I beat down the buying impulses that sporadically surfaced.

But in September of this year I could no longer resist the deep primal urge. I ordered an ICOM IC-R70 modified from Electronic Equipment Bank, Vienna, Virginia.

Oh, the joy of receiving that big box from UPS! The rhapsody of unwrapping, checking and putting it into operation! What a present I had given myself! There should have been a holly-decorated card inside reading:

"Merry Christmas, Al! You deserve it."

"From your best friend."

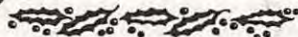

Christian Radio Voices

by Marlin Field, 128 Oak, Hillsdale, MI 49242

Back in 1967 I was sitting in the house when the telephone rang. I answered and the person on the other end said, "Hello, this is Doug Peters from HCJB." I didn't know what to say. I wondered why he was calling me from Ecuador. He was as loud as if he were in Benton Harbor, Michigan, where we lived at the time. As it turned out, he was in Benton Harbor, Michigan. He was in the states for a few weeks; he was speaking at a church in Bridgman, about twenty miles away, and he wanted to come by and get personally acquainted. At the time he was in charge of Radio Circle, a project of HCJB to place pretuned radios into the hands of as many Ecuadorians as possible. Doug knew of me through my reception reports to HCJB and my financial contributions to Radio Circle.

If I'd heard those same words of Peters before 1960--the year I began DXing--I really would have been dumbfounded, because before I started this hobby, I'd never heard of HCJB, or TGNA, or FEBC, or any of the other Christian shortwave radio stations functioning at the time.

This aspect of shortwave broadcasting all started close to thirty years before that, on December 25, 1931, to be specific, when a 250 watt station started broadcasting religious messages in Spanish from high in the Andes Mountains. That station--the first station I heard when I started DXing--was one familiar to all of us today, La Voz de los Andes, HCJB.

HCJB



The number of Christian stations has increased considerably in these fifty years, as can be seen by the list accompanying this article. One of the newest is Emisora Armonias del Caqueta in Florencia, Colombia, a Catholic station which started broadcasting on November 23, 1982. The Far East Broadcasting Co. will soon have a station broadcasting from Saipan. With the lifting by the Federal Communications Commission, the U.S. regulatory agency, of its ban on licenses for private shortwave stations, we may expect to see the number of such stations on American soil to increase. KNLS is now broadcasting from Alaska.

Broadcasting from American soil is more feasible today than it has been in the past, because with the powerful transmitters which are now available, stations can now reach audiences which formerly could be reached only by a nearby broadcasting station.

There's still another reason for broadcasting from within the territorial jurisdiction of the United States. In some countries, the government has interfered with the operations of stations. In June, 1977, after a coup in Seychelles, FEBA announced, "For a temporary period this station will not be broadcasting at the request of the provincial government, for security reasons." The interruption lasted for about two weeks; Radio Pio XII in Bolivia was off for a longer period of time.

Radio Cordac was not so fortunate. Like FEBA, Cordac had been off the air once before because of political problems in Burundi, but on February 21, 1977, the station was informed that only government stations would be allowed to broadcast in the country. CORDAC had been operating in Burundi since 1963, a joint project of the Kansas Yearly Meeting of Friends, the Free Methodist Church, and the World Gospel Mission. ETLF, the station of the Lutheran World Federation Broadcasting Service, suffered a similar fate; it was nationalized by the Ethiopian Revolutionary Government at about the same time. ETLF is now broadcasting from Africa No. 1 in Gabon. A few years ago 4VEH, to avoid entanglement in local politics, refused to meet the broadcast demands of rebels who landed on the Haitian coast near Cape Haitien.

The stations not nationalized by the government have been affected by the nationalistic feeling prevalent now in countries at one time dominated by outsiders. They are hiring nationals for positions once held primarily by Americans. FEBC in Manila and 4VEH, to mention just two, now have nationals as managers. One, TIPC in San Jose, Costa Rica, has been turned over completely to the local inhabitants, and the Latin American Mission, which once held local responsibility for the operation of the station, no longer has an office in Central America.

Like other stations, more so government than commercial ones, a number of the Christian broadcasters now use more than one frequency. This is especially true of the more powerful ones, such as TWR, FEBC and HCJB. The 1962 World Radio-Television Handbook, the oldest I have, lists HCJB on three frequencies; today, the total is ten times that. In 1962 KGEI was operating on the single frequency of 15225 kHz; the most recent WRTH gives seven frequencies. TGNA in Guatemala, a not-so-powerful station, uses frequencies in the 31, 49 and 90 meter bands. A station with even less power, TIPC, also operates in three bands.

The Christian voices have also increased in power. HCJB no longer operates at 250 watts. In fact, most of them don't. The FEBC has a number of 50,000 watt transmitters in Philippines as well as a 250,000 watt one for its Latin American voice, KGEI. The most powerful is HCJB with a 500,000 watt transmitter, which was built in Elkhart, Indiana, USA.

The Christian broadcasters today do not limit themselves to one language as HCJB did during its first six years of existence. HCJB became a bilingual station in 1937 with the addition of English language programming. Around fifteen other languages may also be heard on that station today. Some international broadcasters use close to twice as many languages and dialects as HCJB, such as FEBC. A number of Latin American stations transmit not only in the Spanish language but in the languages of the Indians in their broadcast area, as Radio Maya in Guatemala and Radio Rio Amazonas in Ecuador.

The programs on the Christian radio voices are not, as one might think, all of a religious nature. In addition, to the religious programs, some of which are entirely music, stations broadcast news, classical music and DX information. More and more the stations are diversifying their programming in an effort to increase the size of their audiences. Now one can hear about the culture of Ecuador along with some beautiful flute music from the Andes on HCJB, or marimba music on TGNA. I think one of my biggest surprises was to hear a commercial in English over Radio del Pacifico in Lima, Peru. It caused me to question at the time whether the station was operated by TEAM. I think I've heard one other Protestant station, WINB, with commercials. I don't know why it is that the Catholic stations are more likely to have commercial announcements.

DXers are constantly reminded to send return postage when requesting a verification from a station, for courtesy if for no other reason. For the religious oriented station there is a far more important reason--and that's all tied up in the financial support of the station. With the exception of one, Vatican Radio, none receives monetary support from a government, and as has just been pointed out, very very few receive revenue from commercials.

Most of their income is in the form of individual contributions that reach the station through various channels. It may be that individuals contribute to their church and the money is then forwarded to the station. Or individuals may make their contributions directly to the station or to the headquarters of the missionary group operating the station. Most of these, for the more powerful and best known broadcasters, are located in the United States. WYFR, TWR, FEBC, HCJB, 4VEH, HRVC, TGNA and ELWA all fall into this category. HCJB holds "radiothons" on Christian stations on the broadcast band in the United States as one means of raising money for its missionary work. The addresses of the headquarters may be found in the World Radio-Television Handbook.

The individual in contributing to a missionary organization should specify if he wants his money used for radio work; otherwise, it may be used as the organization sees the need. This means, for example, that if one contributes to the Sudan Interior Mission, the money may be used for its station in Africa, ELWA, for the mission hospital in Liberia, for its African periodicals, or for some of its other projects. One may even specify that he wants to sponsor a certain program in a certain language on the station. Two well known sponsors on ELWA were Mr. and Mrs. W.R. Tobert, the late President and First Lady of Liberia. Some years ago I heard of a DXer who was a sponsor of a program on a FEBC station in the Philippines; the cost now is \$2 per minute.

• TO MAKE CHRIST KNOWN TO AFRICA •



Occasionally the stations spell out their needs in the literature they send to DXers and others on their mailing list. It may be that the station needs money to repair a transmitter, or money to buy a new one, or money to pay for the increased cost of station operation brought on by inflation. On one occasion, two DXers responded to the need of ELWA by buying a reel-to-reel tape recorder and sending it to Monrovia.

Another source of income for the religious oriented station is the religious organizations that sponsor programs on that station, such as the Pacific Garden Mission, the Billy Graham Evangelistic Association, and the Good News Broadcasting Association to mention a few.

Something else that I've learned in my years of DXing the Christian stations is that they are concerned with both the spiritual and nonspiritual lives of their listeners. Most of us remember the earthquake in Guatemala a few years ago. TGNA turned over its facilities to the Guatemalan government when the government station was knocked off the air. Some of us heard messages about survivors being broadcast by not only TGNA but also by KGEI as well. After that, TGNA and the Central American Mission (now called CAM International), which operates TGNA, were deeply involved in rebuilding what the earthquake had torn down.

Some of the stations, such as Radio Chortis in Guatemala and Escuelas Radiofonicas Populares in Ecuador, operate radio schools through pretuned receivers located in their listening area. The purpose of the schools is to reduce the illiteracy rate of their adult listeners. Another Guatemalan station, La Voz de Nahuala, has had what it called the "Seed Project". Through its classes over its pretuned radios, adults received instruction in how and when to plant certain garden seeds, which they obtained from the station. After the harvest, the women were taught different ways of preparing the vegetables they had grown. Probably the most well known station, and also one of the oldest with radio schools, is Radio Sutatenza in Bogota, Colombia. It has been estimated that its broadcasts reach 12 million in that country and its neighbors.

For me, DXing the Christian radio voices has been one of the most rewarding aspects of the hobby. It has been in part because it has brought into my home visits from station personnel (HCJB and ELWA) as well as telephone calls (TGNA); it has brought me into contact with them through my church (TWR, HCJB and ELWA); and it has brought me into contact with them at my work. One hot, muggy day in late August a few years ago, I was pleased to have a visit from the program director of HRVC. On furlough from his position in Tegucigalpa, Honduras, he, his wife, and children were on their way with a U-Haul trailer behind their car to Iowa, where they would live for one year before returning to Central America. Reminders of that visit are on the walls of my radio room--a large pennant and two pieces of Mayan art work.

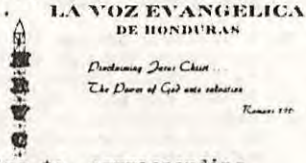

A summary statement might be that by listening to, corresponding with, and reading about the missionary stations, one can increase his knowledge of what Christians are doing around the world through radio. It seems to me that the words of Christ are truly being fulfilled, "Go ye into all the world and preach the Gospel."

A List Of Christian Stations on Shortwave

- KNLS, Anchor Point, Alaska
- Caribbean Beacon, Anguilla
- Radio Cruz del Sur, La Paz, Bolivia
- Radioemisoras Bolivia, Oruro, Bolivia
- Radio Santa Ana, Santa Ana de Yacuma, Bolivia
- Radio Pio XII, Oruro, Bolivia
- Radio Marumby, Florianopolis, Brazil
- Radio Aparecida, Aparecida, Brazil
- Radio Sociedad de Feira de Santana, Feira de Santana, Brazil
- Radio Educadora de Braganca, Braganca, Brazil
- Radio Educacao Rural de Coari LTDA, Coari, Brazil
- Emisora Armonias del Caqueta, Florencia, Colombia
- Emisora Kennedy (La Voz de Maria), Bogota, Colombia
- Radio Sutatenza, Bogota, Colombia
- TIFC, San Jose, Costa Rica
- La voz del Napo, Tena, Ecuador
- HCJB, Quito, Ecuador
- Radio Paz y Bien, Ambato, Ecuador
- Radio Luz y Vida, Loja, Ecuador
- Radio Rio Amazonas, Macuma, Ecuador
- Radio Federacion Sucua, Sucua, Ecuador
- Radio Jesus del Gran Poder, Quito, Ecuador
- La Voz del Santuario, Banos, Ecuador
- Escuelas Radiofonicas Populares, Riobamba, Ecuador
- Radio Catolica, Quito, Ecuador (in WRTH but not reported in years)
- La Voz de Galapagos, Puerto Baquerizo Moreno, Galapagos
- TWR, Agana, Guam
- Radio Tezulutlan, Coban, Guatemala
- Radio Chortis, Jocatan, Guatemala

ICR International Christian Radio

Emisora Armonias del Caqueta



RADIOFONIA JESUS DEL GRAN PODER

EMISORA CATOLICA CULTURAL "LUZ Y VIDA"

CHRISTIAN STATION LIST (cont'd)

Union Radio, Guatemala, Guatemala
La Voz de Nahuala, Nahuala, Guatemala
TGNA, Guatemala, Guatemala
TGBA, Radio Maya, Huehuetenango, Guatemala
Radio Mam, Cabrican Huitan, Guatemala
4VEH, Cape Haitien, Haiti
Radio Luz y Vida, San Pedro Sula, Honduras
HRVC, Tegucigalpa, Honduras
Radio Progreso, El Progreso, Honduras
Radio San Isidro, La Ceiba, Honduras
La Voz de la Mosquitia, Puerto Lempira, Honduras
Radiolandia, Comayagua, Honduras (listed in WRTH as only on medium wave)
Voice of Hope, Lebanon (address in Israel)
ELWA, Monrovia, Liberia
Radio Huayacocotla, Mexico
TWR, Monte Carlo, Monaco
TWR, Bonaire, Netherlands Antilles
Radio Charitas, Asuncion, Paraguay
Radio del Pacifico, Lima, Peru
La Voz de la Selva, Iquitos, Peru
Radio Cultural Amauta, Huanta, Peru
Radio Santa Rosa, Lima, Peru
Radio Veritas, Manila, Philippines
SEARV, Manila, Philippines
FEBC, Manila, Philippines
Radio Renascentia, Lisbon, Portugal
FEBC, Saipan
FEBA, Mahe, Seychelles
TWR, Manzini, Swaziland
WINB, Red Lion, PA, USA
KGEI, Redwood City, CA, USA
WYFR, Oakland, CA, USA (transmitters at Okeechobee, Florida)
Vatican Radio, Vatican City, Vatican



FEBA - Seychelles



World Inter-National Broadcasters

Transmitter Power: 50,000 Watts - ERP in Target Area 10 Watts CH 1,000,000 Watts
Transmitter Site: 800 W. 12th St., U. S. A.

HIGH ADVENTURE BROADCASTING NETWORK
814 7th St. San Mateo, California 94404



Stations No Longer Broadcasting

Radio Ecclesia, Luanda, Angola
Radio Cordac, Burundi
ETLF, Addis Ababa, Ethiopia (now uses Africa No. 1 facilities)
Radio Pax, Mozambique

(Editor's note...Marlin's article first appeared in the December 1974 Shortwave Center and quite a bit has happened since then. That article listed roughly 49 "active" SWBC religious-oriented stations. The head count now is 62, though some are presumed inactive, such as LV del Santuario, Emisora Kennedy, R. Catolica, etc. If you are into awards, NASWA offers two in this area: the Ecclesiastic DXer award is available for verification of 15 religious-oriented stations, and the Senior Ecclesiastic DXer award for verification of 25.-JH)

RF INTERFERENCE AND THE HOME COMPUTER

by Bill Krause, 6700 153rd Lane NW, Anoka, MN 55303

The home computer is one of the best friends the radio hobbyist has. But like a lot of our best friends, it has one very annoying bad habit: the home computer's a source of RF interference. All home computers, from the most expensive to the least expensive, are guilty to some extent. How much interference the computer generates, generally speaking, is not so much a reflection of cost as it is date of purchase. While, for reasons to be explained shortly, the more expensive units do have some tendency to be less of a problem, the tightening of regulations governing RF emissions of newer computers is a more significant factor. Let's have a look at what in a computer causes the interference, and some possible ways of managing the problem.

The most significant source of RF interference related to the use of home computers comes from the TV set that they are usually hooked up to and the RF modulator which transmits the computer's video and audio signals to the TV. Monitors, commonly used with more expensive setups and sometimes with less expensive ones, do not generate as much RF interference because they don't make use of the RF modulator, which is a miniature TV transmitter, and because they do not have a tuner stage. However, while monitors create significantly less interference than do conventional TVs, they still must be considered a serious cause of RF interference. A second very significant source of RF is the electrical line noise generated by the power supply of the computer and any peripherals such as printers that must also be hooked up. Finally, there is the computer itself. There are usually crystal oscillating circuits and their electronic components within the computer itself that generates considerable RF interference.

So how do we minimize the impact of all this RF on our ability to enjoy the radio hobby? Well, let's briefly look at each source of RF and deal with them in turn. First let's look at the TV and RF modulator associated with it. The cost of black and white monitors now begins at \$50 and color monitors begin at \$200. If the computer is viewed more as a serious tool rather than primarily as a game machine with only minor side benefits, then even the user of less expensive computers such as the VIC-20 or Timex-Sinclair would be well advised to seriously consider a monitor. Besides making less trouble for your radio, the monitor will provide considerably better readability for the computer. Another thing that can be done in this area is to use the best possible connecting cables, using the most shielding. Also keep the length of the cables as short as is practical for your particular setup. These suggestions will help you deal with the most significant source of RF from the home computers.

Another big source of RF interference is the power supply of the computer itself and some of its associated peripherals such as a printer. There really is only one thing you can do about this and that is to keep your computer and its attachments as far away as possible from your radio. But, of course, if you are going to use the two together in any sort of meaningful way, there will be real limitations as to just how far you can go. However, it should be possible to plug the radio and computer in on different outlets, at opposite ends of the room if possible. I have found that this can make an appreciable difference.

Finally, there is the computer itself and its own electronic circuitry. This is a tougher problem, but a problem you can deal with to some extent. First, as I mentioned earlier, newer editions of computers, even of the same make and model, have been forced by FCC regulation to reduce their RF emissions. Generally speaking, they have accomplished this by adding more internal shielding, but sometimes simply by using newer and higher grade electronic components. One manufacturer was able to reduce the number of components by 2/3rds while producing a machine that worked just as the original did. This undoubtedly reduced RF emissions in their computer. But how can you approach the problem? Again, keeping the radio and computer as far apart as possible will help. Another approach is to provide your own additional shielding. Wrapping as much of your computer as possible in a couple layers of aluminum foil will make quite a difference. It won't do anything for the aesthetics, but it will make your radio a lot happier.

It's an unavoidable fact that your home computer is going to cause RF interference that will affect your radio, and probably the family TV too. It is, though, a problem which can be managed in a manner so as to reduce the impact of the RF interference to a minimum. A home computer and a radio can co-exist in the same home, indeed even in the same room, and they can even work together for the enjoyment of their user.

My thanks to everyone for a fine month! A special welcome to Nick Pappas who will be editing his own column directed to SWBC program enthusiasts.

Here's wishing you all a very happy Christmas and loads of good DX in '84. Be good and 73,

HUKERIN



"Herky"

Compiled by Roger Legge, Box 232, McLean, VA 22101

TO EASTERN & CENTRAL NORTH AMERICA

MORNING

<u>EST</u>	<u>GMT</u>		
6:00-7:00am	1100-1200	Jerusalem, Israel	11610, 13745, 15585, 17630
		Peking, China	9820
6:00-7:50am	1100-1250	Pyongyang, No. Korea	9745, 9977
6:00-8:00am	1100-1300	Moscow, USSR	6115h, 15135, 15455, 17810 (from 1200)
6:00-8:30am	1100-1330	London, England	5965c, 11775w, 15070
6:15-7:35am	1115-1235	TWR, Bonaire, NWI	15255
7:00-7:30am	1200-1230	Helsinki, Finland	15275, 15400
7:00-7:30am Su	1200-1230 Su	Oslo, Norway	21730
7:00-8:00am	1200-1300	Peking, China	9820, 11650
7:00-10:00am	1200-1500	Melbourne, Australia	9580
7:15-10:30am	1215-1530	HCJB, Quito, Ecuador	15115, 17890, 11740 (to 1430)
7:30-7:45am	1230-1245	Athens, Greece	11645, 15630
7:30-8:00am	1230-1300	Vienna, Austria	17770
8:00-8:25am M-F	1300-1325 M-F	Montreal, Canada	9575, 11955
8:00-8:30am	1300-1330	Helsinki, Finland	15400, 17800
8:00-10:00am	1300-1500	Moscow, USSR	11840h, 15135, 15150, 17810
8:15-8:45am	1315-1345	Berne, Switzerland	21570
9:00-9:30am	1400-1430	Helsinki, Finland	15400
		Stockholm, Sweden	17860
9:00-9:45am M-F	1400-1445 M-F	Brussels, Belgium	17610
9:00am-12n Su	1400-1700 Su	Montreal, Canada	11955, 17820
10:00-10:30am	1500-1530	Helsinki, Finland	15400, 17800
10:00-10:30am Su	1500-1530 Su	Oslo, Norway	17840
10:00am- 12n	1500-1700	Moscow, USSR	11840h, 15455
11:00am-12:45pm	1600-1745	London, England	9515c, 15070, 15260c
	(Sa/Su from 1500)		
<u>AFTERNOON</u>			
12n - 5:00pm	1700-2200	Moscow, USSR	7440, 9710, 11840h, 11860 (to 21), 12010 (to 20)
3:00-3:30pm	2000-2030	Jerusalem, Israel	9440, 9815, 11655
4:30-5:00pm	2130-2200	Sofia, Bulgaria	7115, 9665
<u>EVENING</u>			
5:00-6:00pm	2200-2300	Ankara, Turkey	9560
		London, England	5975, 6175w, 7325, 15260a
		Moscow, USSR	7115, 7165, 7185, 7440
5:30-6:30pm	2230-2330	Sofia, Bulgaria	9700, 11720
5:30-6:50pm	2230-2350	Tripoli, Libya	11815
6:00-6:30pm	2300-2330	Stockholm, Sweden	9695, 11710
		Vilnius, Lith.SSR	9685, 9750
6:00-6:30pm Su	2300-2330 Su	Oslo, Norway	9590
6:00-7:30pm	2300-0030	London, England	5975, 6120c, 6175w, 7325, 9590c, 11750a
6:00-8:30pm	2300-0130	Moscow, USSR	7100, 7150, 7165, 7185, 7215, 7440, 9765, 6115 (from 00)
6:45-7:45pm	2345-0045	Tokyo, Japan	15300, 17825
7:00-7:30pm	0000-0030	Jerusalem, Israel	7410, 9815, 11655
		Montreal, Canada	5960, 11850
		Tirana, Albania	7065, 9750
7:00-8:00pm	0000-0100	Peking, China	9860, 11650, 11945
		Sofia, Bulgaria	9700, 11720
7:00-9:00pm	0000-0200	Madrid, Spain	9630, 11880
7:15-8:00pm	0015-0100	Berlin, DDR	9730, 11975

<u>EST</u>	<u>GMT</u>		
7:30-8:00pm	0030-0100	Kiev, Ukr.SSR	7205, 9685, 9750
7:30-8:15pm	0030-0115	Brussels, Belgium	5910
7:30-9:30pm	0030-0230	HCJB, Quito, Ecuador	9745, 15155
7:30-10:30pm	0030-0330	London, England	5975, 6120c, 6175w, 7325
7:50-8:05pm	0050-0105	Vatican City	6015, 9605, 11845
8:00-8:20pm	0100-0120	Rome, Italy	5970, 9575
8:00-8:30pm	0100-0130	Jerusalem, Israel	7410, 9815, 11655
		Montreal, Canada	5960, 11850
8:00-8:30pm Su	0100-0130 Mo	Oslo, Norway	6020, 11860
8:00-8:45pm	0100-0145	Berlin, DDR	9730, 11975
8:00-8:50pm	0100-0150	Cologne, W.Germany	6040w, 6085, 6145, 9545w, 9565, 11785m
8:00-9:00pm	0100-0200	Prague, Czechoslovakia	5930, 7345, 9540, 9740, 11990
8:00-10:00pm	0100-0300	Peking, China	9860, 11650, 11945 (01-02)
8:00-11:50pm	0100-0450	Havana, Cuba	11930, 15300
8:30-8:45pm	0130-0145	Athens, Greece	9420, 9865, 12085
8:30-9:00pm	0130-0200	Tirana, Albania	7120, 9750
		Vienna, Austria	5945, 9770
8:30-11:00pm	0130-0400	Moscow, USSR	6115h, 7100, 7115, 7150, 7165, 7185 (to 83), 7215 (to 03), 7440, 9700, 9765
8:45-9:15pm	0145-0215	Berne, Switzerland	6135, 9635, 9725, 11715
9:00-9:30pm	0200-0230	Budapest, Hungary (not Su)	9585, 9835, 11910
		Jerusalem, Israel	7410, 9815, 11655
9:00-9:50pm	0200-0250	Johannesburg, So.Africa	5980, 9615, 11730
9:00-10:00pm	0200-0300	Brasilia, Brazil	15290
		Bucharest, Romania	5990, 6155, 9510, 9570, 11810, 11940
		Montreal, Canada (M-F)	5960, 11845
		Taipei, Taiwan (via WYFR)	5985
		Warsaw, Poland	6095, 7145, 7270, 9525, 11815
9:00-10:00pm	0200-0330	Cairo, Egypt	9475, 12000
9:30-10:15pm	0230-0315	Berlin, DDR	9730, 11975
9:30-10:25pm	0230-0325	Hilversum, Holland	6165b, 9590b
9:30pm-12Midt	0230-0500	HCJB, Quito, Ecuador	9745, 15155
10:00-10:30pm	0300-0330	Budapest, Hungary	9585, 9835, 11910
		Kiev, Ukr.SSR	7185, 7205, 9750
		Lisbon, Portugal	6060, 11925
		Montreal, Canada	5960, 9755
10:00-10:30pm Su	03-0330 Mo	Oslo, Norway	6015
10:00-10:50pm	0300-0350	Ankara, Turkey	9560
10:00-11:00pm	0300-0400	Prague, Czechoslovakia	5930, 7345, 9540, 9740, 11990
		Warsaw, Poland	6095, 7145, 7270, 9525, 11815
10:30-10:45pm	0330-0345	Athens, Greece	9420, 9865, 12085
10:30-11:00pm	0330-0400	Dubai, UAE	11755, 15435
		Tirana, Albania	6200, 7300
		Vienna, Austria	5945, 9770
10:30-11:30pm	0330-0430	London, England	5975, 6120c, 6175w
10:30pm-1:00am	0330-0600	Havana, Cuba	11760
11:00-11:00pm	0400-0430	Bucharest, Romania	5990, 6155, 9510, 9570, 11810, 11940
		Montreal, Canada	5960, 9755
11:00pm-12Midt	0400-0500	Sofia, Bulgaria	7115
11:00pm-1:00am	0400-0600	Moscow, USSR	7100, 7150, 7165, 6115h (to 05)
12:00-12:15am	0500-0515	Jerusalem, Israel	9009, 9420, 9815

Morning

	<u>PST</u>	<u>GMT</u>		
6:00-8:00am		1400-1600	Melbourne, Australia	9580
6:00-10:00am		1400-1800	Moscow, USSR (via Khab.)	5900, 7175, 7290, 9795
7:00-7:30am		1500-1530	Helsinki, Finland	15400, 17800
7:00-7:45am		1500-1545	Tokyo, Japan	9505
7:30-7:45am		1530-1545	Athens, Greece	11645, 15630, 17565
8:00-9:45am		1600-1745	London, England	9515c, 9740e, 15070, 15260c
9:00-9:30am		1700-1730	Tokyo, Japan	9505
10:00am-12N		1800-2000	Moscow, USSR (via Khab.)	7290, 9580 (to 19), 11860, 12050
11:00-11:45am		1900-1945	Tokyo, Japan	15300

Afternoon

12n-2:00pm	2000-2200	Moscow, USSR (via Khab.)	9580 (to 21), 11860, 12050, 15455
1:00-1:30pm	2100-2130	Tokyo, Japan	15300
1:40-2:40pm	2140-2240	Taipei, Taiwan	11825, 15270, 15345
2:00-5:00pm	2200-0100	Moscow, USSR (via Khab.)	12050, 15140, 15455, 17720, 21565
3:00-3:30pm	2300-2330	Vilnius, Lith. SSR (via Khab.)	15100, 15240, 17870
3:00-3:45pm	2300-2345	Tokyo, Japan	17755
3:00-4:45pm	2300-0050	Pyongyang, No. Korea	15230
4:00-6:00pm	0000-0200	Madrid, Spain	9630, 11880
4:30-5:00pm	0030-0100	Kiev, Ukr. SSR (via Khab.)	15100, 15240, 17870

Evening

4:00-7:30pm	0000-0330	London, England	6120c, 6175w, 11750a
4:30-6:30pm	0030-0230	HCJB, Quito, Ecuador	9745, 15155
4:50-5:05pm	0050-0105	Vatican City	6015, 9605, 11845
5:00-5:20pm	0100-0120	Rome, Italy	5970, 9575
5:00-5:30pm	0100-0130	Jerusalem, Israel	7410, 9815, 11655
		Montreal, Canada	5960, 11845
		Tokyo, Japan	17755
5:00-5:30pm Su	0100-0130 Mo	Oslo, Norway	9610
5:00-6:00pm	0100-0200	Taipei, Taiwan	11825, 15345
5:00-7:00pm	0100-0300	Peking, China	9860, 11650, 11945 (to 02)
5:00-8:00pm	0100-0400	Moscow, USSR (via Khab.)	12050, 15140, 15455, 17720, 21565 (to 02)
5:30-5:45pm	0130-0145	Athens, Greece	9420, 9865, 12085
5:30-6:30pm	0130-0230	Tokyo, Japan	15195, 17825, 21610, 21640
6:00-6:30pm	0200-0230	Budapest, Hungary (not Su)	9585, 9835, 11910, 12000
		Jerusalem, Israel	7410, 9815, 11655
6:00-6:30pm Su	0200-0230 Mo	Oslo, Norway	11860
6:00-6:50pm	0200-0250	Johannesburg, So. Africa	5980, 9615, 11730
6:00-7:00pm	0200-0300	Brasilia, Brazil	15290
		Montreal, Canada (M-F)	5960, 11850
		Seoul, So. Korea	11810, 15575
6:00-7:30pm	0200-0330	Cairo, Egypt	9475, 12000
6:00-8:00pm	0200-0400	Melbourne, Australia	15320, 17795
6:30-7:00pm	0230-0300	Stockholm, Sweden	9695, 11705
6:30-9:00pm	0230-0500	HCJB, Quito, Ecuador	9745, 15155
7:00-7:30pm	0300-0330	Budapest, Hungary	9585, 9835, 11910, 12000
		Kiev, Ukr. SSR (via Khab.)	15100, 15240, 17870
		Lisbon, Portugal	6060, 11925
		Montreal, Canada	5960, 9755
		Tokyo, Japan	17755
7:00-7:30pm Su	0300-0330 Mo	Oslo, Norway	9670
7:00-7:50pm	0300-0350	Taipei, Taiwan	11745, 11825, 15345
7:00-8:00pm	0300-0400	Ankara, Turkey	9560
		Prague, Czechoslovakia	5930, 7345, 9540, 9740, 11990
7:00-9:00pm	0300-0500	Peking, China	11650, 11945 (to 04), 15120

ENGLISH LANGUAGE BROADCASTS TO WESTERN NORTH AMERICA (2)

FST	GMT		
7:30-7:45pm	0330-0345	Athens, Greece	9420, 9865, 12085
7:30-8:00pm	0330-0400	Dubai, UAE	11755, 15435
		Tirana, Albania	6200, 7300
7:30-8:15pm	0330-0415	Berlin, DDR	9560, 11840, 11890
7:30-8:30pm	0330-0430	London, England	5975, 6120c, 6175w
7:30-10:00pm	0330-0600	Havana, Cuba	11760
7:55-8:00pm	0355-0800	Yerevan, Arm.SSR (via Khab.)	15100, 15240, 17870
8:00-8:30pm	0400-0430	Bucharest, Romania	5990, 6155, 9510, 9570, 11810, 11940
		Montreal, Canada	5960, 9755
8:00-9:00pm	0400-0500	Moscow, USSR (via Khab.)	7260, 9580, 12050, 15140, 15455
		Sofia, Bulgaria	7115
8:00-10:00pm	0400-0600	TWR, Bonaire, NWI	9535
8:30-9:00pm	0430-0500	Berne, Switzerland	9725, 11715
		Vienna, Austria	5945, 9770
8:30-11:30pm	0430-0730	London, England	6175w, 9510w
9:00-9:15pm	0500-0515	Jerusalem, Israel	9009, 9420, 9815
9:00-9:30pm	0500-0530	Tokyo, Japan	15300
9:00-9:50pm	0500-0550	Cologne, W.Germany	5960, 6120, 9690
9:00-10:00pm	0500-0600	Seoul, So.Korea	11810
9:00-11:30pm	0500-0730	Melbourne, Australia	15320, 17795
9:00pm-12mdt	0500-0800	Moscow, USSR (via Khab.)	7175, 7260, 7300, 9505, 9665 (to 07), 9795
9:30-10:00pm	0530-0600	Lisbon, Portugal	6075, 9575
9:30-10:30pm	0530-0630	Hilversum, Holland	6165b, 9715b
		Madrid, Spain	9630, 11880
10:30-11:15pm	0630-0715	Berlin, DDR	6080, 11840, 11890
10:30pm-12mdt	0630-0800	Havana, Cuba	9525
11:00-11:15pm	0700-0715	Tokyo, Japan	15300

Relay stations: a - Ascension, b - Bonaire, NWI, c - Canada (Sackville), h - Havana, m - Malta, s - Singapore, w - West Indies (Antigua)

Changes of interest: 1000-1300 Moscow via Havana 11840 to 6115, 1000-2000 Moscow 15100 to 15455, 10-15 Moscow 15485 to 17810, 1100-12 Peking new program 9820, 1115 Bonaire 12815 to 15255, 1200 Helsinki 17800 to 15275, 1230 Vienna 17860 to 17770, 1300 & 1500 Helsinki 21475 to 17800, 1400 Stockholm 21615 to 17860, 2200 & 0300 Ankara 11755 to 9560, 0000-0300 Peking 15385/15520 to 9860/11650/11945, 0030 Brussels 9880 to 5910, 0100 Rome 11800 to 5910, 0145 Berne 15305 to 9635.

1984 World Radio TV Handbook The 1984 WRTTB will be published in Jan. or Feb. 1984 and retail at \$17.50 in the US; orders are being taken at \$15 USPS Book Rate, worldwide, or United Parcel Service, US only, (please specify) or \$16 First Class Mail, US only. Calif. residents must add 6% sales tax. Orders, with an SASE for confirmation of shipment, and a check or money order in \$US on a US bank, payable to CENTURY PRINT SHOP, should be mailed as soon as possible (no deadline) to: Century Print Shop, Don Erickson, 6059 Essex St., Riverside, CA 92504-1599. Inquiries welcome, (714) 687-5910. In Canada, please include \$21 fourth class or \$23.50 special delivery and mail orders for receipt no later than Jan. 7, to: Canadian International DX Club, Don Moman, 6815 12th Avenue, Edmonton, Alberta, Canada T6K 3J6.

NASWA TROPICAL BANDS GUIDE 1983

Lists 2000-5900 kHz Log Reports from 2/76 to 1/83. Exact frequency schedules with variations or fade in/fade out times, NA Rarity Guide, Country/City/Station name check boxes for heard/QLS'ed/taped, miscellaneous notes, intro with abbreviations, etc. Price is \$3.00 in North America, \$4.00 elsewhere by air from George Sherman, Box 2284, Minneapolis, MN 55402.



DECEMBER 1983

Listeners Notebook

GLENN HAUSER, Box 6287, Knoxville, TN 37914

PROPER CREDIT

Other publications and broadcasters may use material from LN provided due credit is rendered to the original reporter and the NASWA Listeners Notebook. This courtesy does not extend to closed organizations which do not allow reciprocal access to their publication. BBC Monitoring Service items (Designated WBI for World Broadcasting Information) are copyright and may not be reproduced without BBCMS permission. The most important items have been broadcast immediately on WRNO WORLD OF RADIO or RCI SWL DIGEST, not otherwise mentioned herein. All contributions to LN are gratefully received, but your editor cannot promise a personal reply because of severe time constraints. Material for LN should be marked as such each time (not just on the envelope), as input for other outlets also comes to Box 6287. Reports to gh should not be cut into little strips. It also helps if you use one side of paper only, and do not mix LN items with other correspondence. All times, dates and days are day/month GMT, u.o.s. Please do not ask me for advice on receivers or other equipment. Thanks (gh)

AFGHANISTAN 24/10 R Afgh appeared to have difficulties in feeding DS to xmters. Pgm feed became more & more intermittent from 1536 apx and was lost completely around 1555. Xmters remained on open carrier. 1601, two RA channels, 4740 & 4450 came back w/pgms not of R Afgh, but of the DS of the V of the Islamic Rep of Iran in Tehran; other audible xmters remained unmod. This lasted til apx 1615 when 4740 & 4450 xmters returned to OC. Normal RA pgming restored just before 1620. After some mx, a RA ancr apologised to listeners, saying pgms'd been lost for a few moments due to a power cut (WBI 27/10) So how did Iran pgms get into this? Off-air relays? (gh) Since 1/11, RA ES in AR 1700-1725 hrd on 9705 & 7295 (WBI 10/11)

ALGERIA Since 17/10, Alg R's AR svc hrd on 981 instead of 891 kHz, //other MW & 6160 (WBI 27/10) Alg R AR svc obs returned to 981, //6160 & MW 5/11; second high power xmt on 891 hrd 7/11 w/FR svc // 17745 15215 9685 9640 9510 254 (WBI 10/11)

ARGENTINA Since beginning of Nov, RAE in EG on 15345 2200-2230 ex-2230-2300 (WBI 10/11) R Nacional Mendoza, 6180 audible Sundays, t/in 0925-0950, best ever; because Turismo, Venezuela signs on around 1010 or 1015 instead of 0905 weekdays (Maxfield Greenwood, Sedgwick ME)

BELGIUM LMI
/more, LMI

BANGLADESH RB ancd that w/intro of winter sked 1/11, stn'd s/on daily 0030 ex-0000 (WBI 3/11)

BOTSWANA R Botswana, 4848 *0340 w/18 mins of animal farm (Dario Monferini, Milano, Italy, Play-DX) R Botswana quoted Bots President on 3/11 at commissioning ceremony of the first of four 50 kW SW xmters, that the SW expansion pgm'd be complete by mid-1984, when remaining three xmters installed. This'd represent a big step forward in Bots rbc development. All radio listeners'd be able to pick up sigs clearly allwhen. Now, outside Gabarone, there were new SW aeriels, which'd carry sig further than it had reached before. R RSA reported that the four xmters were being installed at a cost of just over three megadollars. One xmt, donated by a W German company, just commissioned. Remaining three, still being installed, 'd been bought by Bots (WBI)

BRAZIL R Nacional Boa Vista, testing new 4875 31/10 0310, ex-4835; only date noted (Dario Monferini, Italy, Play-DX) R Bras on 17755 at 1920 9/11 native mx, 1930-1954* GM. 9/11 2100 on 15270 (Chuck Oliver, Spring TX) R Dragão do Mar, 4925, 0730-0500. R MEC on 5990 1900-0300, 9770 & 17875 0900-0300; 11950 inactive temporarily. R Tamó-rio, 9610 relays R Tupi at 1800-0300; also 15370 is active but times unk. 3375 now R Dourados, ex-R Clube 0800-0400. R Globo, São Paulo, 6100 0900-0300. Stn 388) on 9585 shall be 178) R Excelsior, São Paulo 0900-0300. R Congonhas, 3385, 0900-2100. Xapuri on 3406 operates 2 KW 1000-0200 (Antônio Ribeiro da Motta, Brasil, WRTH Newsletter) R Mundial (Globo) is inactive on 4825. R Soc Feira de Santana active again

on 4865. RBras Amazon svc replaced 6120 w/9680, // 11780 15445; Mon-Fri 0800-1600 & 1800-0200; Sat & Sun 0900-1600 & 1800-0100 (ibid.) more, LMI = Last Minute Info

CANADA CKZN, St John's, interesting log 20/10 1002, CBC net nx, poor but clear on 6160 (Richard Stoller, Bogotá DE, Colombia)

CHAD [Cf Nov LN] Upon closer inspection of the SR/SS maps in DXing According to NASWA, 1979 ed., pp. 115-118, gh and I conclude we must not consider them too accurate. They are hand-drawn and lines are not precisely spaced. Moundou SR appears to be Aug 0515, Sept 0505, Oct 0520, Nov 0510, instead of later & later (M Greenwood ME)

CHINA Xinjiang PBS has reactivated 7385 for CH svc ex-3960, //6100 4500 while 7050 has been reactivated ex-3990 to carry Uighur svc, //4735 5800. It is believed they prefer to use higher fqs during summer; may soon go down to 3960 & 3990 for winter. Xinjiang's Mongolian svc on 5060 4220 and Kazakh 5440 4970 remain same (Sarah Weerakoon, Sri Lanka, Nov DSWCI SW News) Both 7385 & 7050 remain active and hrd at time of typing [when?] w/7385 quite strong 1500+ (Noel Green, UKOGBANI, DSWCI Ed.)

Skeds effective 1/11, compiled from pgm pws & monitoring obs: Guizhou PBS, Guiyang in Std CH on 7275 3260 2130-0030, 0150-0600, 0850-1605; mx 2300-2320, 0200-0205, 0400-0430, 1430-1440. Sichuan PBS, Chengdu, First Pgm in Std CH on 7225, 2120-0030, 0030-0200 Tue & Sun, 0320-0600, 0600-0910 not Tue, 0910-1505. Prov/local nx 2300-2320, 0400-0410 not Sun, 1020-1030 not Sun. Second Pgm in Std CH, Tibetan, Yi on 5900 2150-0530, 0950-1320; prov/lcl nx 0030-0050, 1000-1010, 1200-1210 not Sun (WBI 3/11) Gansu PBS, Lanzhou in Std CH on 6155 6005 4865: 2130-0130, 0330-0620, 0900-1600. Nx 2200-2205, 2300-2315, 0430-0445, 1100-1115. Guangxi PBS, Nanning in Std CH, Cantonese, Liuzhou dialect on 4915 2110-0500 & 0850-1605. Nx 2200-2215, 0300-0305 0430-0445, 1025-1030, 1330-1335. Hubei PBS, Wuhan in Std CH on 3940 2100-0605 & 0850-1535; nx 2300-2315, 0230-0235, 0400-0415, 0900-0915, 1000-1005, 1525-1530. Hunan PBS, Changsha in Std CH on 4990 2100-0100, 0320-0515, 0920-1440; nx 2310-2325, 0030-0045, 0400-0410, 1000-1015, 1030-1035, 1150-1155, 1430-1435. Qinghai PBS, Xining in Std CH on 9780 0340-0630; 6260 4940 3950 at 2225-0115, 0340-0630, 0955-1530. Nx 2330-2345, 0400-0405, 1100-1115, 1445-1500. Shaanxi PBS, Xian in Std CH 6176 2120-0625, 0930-1520; nx 2300-2320, 0500-0510, 0940-0945, 1400-1405. Tibetan (Xizang) PBS, Lhasa in Std CH on 9490 7170 5935 4750 2300-0205, 0350-0650, 1000-1455; nx 0000-0015, 0500-0515, 1130-1145, 1430-1445 (WBI 10/11)

COLOMBIA El Tiempo newspaper reported 8/10 that the govt'd ancd that from 9/10, all new radio stns to be established 'd be subjected to a bidding process. Also ancd that 100 radio stns, which'd failed to keep licences up to date, 'd be closed. In addn, R Nacional and offl or private institutions offering strictly cultural pgming 'd be given precedence in allocation of available AM & FM fqs. Per Comms Ministry, decision to close 100 radio stns was made cause they'd not bothered to renew permits in past pentayear. Tho there were cases when Ministry'd unjustly delayed processing of documents, 'absolute negligence' on part of radio stns was common and Comms Ministry was determined to establish order. Per "Nat'l RBCing Plan" decree signed by Pres & Comm Minister 30/9, new radio stns could only be established in the following areas: a) border areas, b) natl terrs & islands, c) municipalities having no radio stns, d) municipalities w/no more than three AM and two FM stns, providing they comply w/strict rules regarding population size. Decree also says at opening of each bidding process, a list of regs'd determine fq, power, other tech & ec requirements, plus pgm nature. El Tiempo added that govt was seeking to end serious irregularities which'd existed for many years. These included: lack of order and favouritism in issuing of permits; proliferation of radio stns to such an extent that to keep going they had systematically violated their programming commitments by giving airtime to people "who swindle the public, such as sorcerers and quacks", and irregularities such as individuals who apply for a licence to run a radio stn of a certain power but who immediately purchase equipment for a much more powerful stn. Therefore, this problem'd be subjected to a more strict system of controls (WBI 20/10)

[Cf Nov LN, LMI] LV de Samaniego, 6350, still active erratically, eg 24/10 0125, weak mixing utes. New on 6534v is LV Cultural de Guamalito, in Norte de Santander, erratic sked *2000-2230v*, loud in Bogotá, rel talk, HJ ppps. Hrd for a month but only Ided 20/10 2050-2200*. Rel stn, talk on local religious events, sermon on evang elization, HJ pop chosen for non-sexual nature. Asks listeners to "informenos de su sintonfa". Not hrd every day, lousy signal. Another new one: LV del Cauca, Puerto Leguizamo, Putumayo, 5225v, in the jungle on the HC border. Hrd for 3 weeks but only Ided 25/10 due to laziness & vicious QRM. f/in 2200, lost after 0200; 2230-2330 mx

pgm sponsored by "best almacén in Pto Leguízamo". Yet another unofficial Colombian. On. 3780, another mixing product, R Cinco 5040-1260, vy loud 24/10 2335. Also an un-ID perhaps Colombian on 5740. Reactivated R Nacional de Colombia 49m xmtr is on 5979.8v, ex-5932, 6260 etc. Not very loud even in Bogotá, e.g. 9 /11 2330; ID is for HJND-570. Zipping around the hot, flat and dull countryside west of Espinal (Tolima) I passed LV del Centro, and a 49m dipole about 3m off the ground. I almost wanted to get off the bus, but it did not seem like a good place to be left without making arrangements in advance, hi. Maybe next week, hi (Richard Stoller, Bogotá DE)

COSTA RICA TIRI, R Impacto, 6150 now has a newblock from 1100, lasting apx 50-80 mins, consisting mostly of interviews and commentaries attacking Nic govt, Fidel Castro, Communism, etc. Per anmts, similar xmsn at 0300 (C M Stanbury, Ont, Nov SWNS) This is neutrality? (gh) Anmts on R Colombia [sic] indicate it carries a svc called 'Free Nicaragua' 0100-0130 every Monday. Produced by Nic Info Centre of the Communication Dept of ANUDE--the Nic Assembly of Democratic Unity. Since 31/10, R Colombia [sic] hrd on 4825 in addn to 1320 (WBI 10/11) Not only BBCMS, but numerous other DX bulletins insist on running this as R Colombia, in some cases assuming it is in the country of the same name, instead of the proper R Columbia, a long-established CR stn on Mf. "Oh" and "oo" sound rather different to me--why do so many have such a problem keeping this straight? (gh)

CUBA RHC in SP on 15525 0200-0600*, VG, maybe USSR xmtr (Bob Padula, RA JP DX 12/11) Doubt it; other times of day obviously from Cuba on this fq, and no USSR relays previously during this time period (gh) RHC on 7385, 0415 22/10, usual stuff, talk on Socialism (Chuck Oliver, Spring TX) Language?

CHILE R Patagonia Chilena, *0930 w/different s/ons different days; & love-song-like anthem "O Patagonia"; but window is narrowing; f/out by 0950 (Maxfield Greenwood, ME) Presumably 6080

ECUADOR Rdif Casa de la Cultura, reactivated on new 3205 after eons. First hrd 22/10 & IDed 25/10 at 2235, phone interviews w/lcl bigwigs praising reactivation of RCC-- Dir. of Caja Agraria, Dir of Casa de la Cultura, etc. All HC mx later on, tho sig getting progressively worse. Also on 3134v, an unID religious stn 2200-0000+ 24/10+ samepgm every day, no IDs or recorded mx, Ecuador? (Richard Stoller, Bogotá C_olombia)

EL SALVADOR R El Salvador, I guess on 9553 at 0032 9/11, class mx, finished number & pulld switch 0034 w/out a word (Chuck Oliver, Spring TX)

FRANCE RFI now testing to SEAs, daily 2230-2400 on 9715 7205, in FR relaying F-Int er. Requested reports to Box 9516 (WBI 27/10) See GULIANA FRENCH

GABON AFP reported 25/10 that Gab authorities'd banned local media from reporting any mx from or about France in protest at the publicity given in F to a critical book about Gabon. First effect of the ban was that the natl radio & TV nets, as well as Africa Number One--the most powerful intl radio stn on the continent--made absolutely no mention on 24/10 of the attack on French troops in Lebanon, while giving extensive coverage to the one against American marines (WBI 3/11) Hmmm, did this apply too to ANO relays of RFI?? This now jeopardized? 'D love to see that book (gh)

GERMANY WEST Sked from DW shows tests in SSB & DSB 'd be conducted on a number of fqs 6/11-12/11. Further long-term xmsns in SSB'd be bc from 13/11 as follows: 0415-0550 6045 150° AR, 0600-1000 9700 255 GM, 1130-1230 11820 045 JP, 1245-1350 15400 75 IN, 1400-1555 11855 090 GM, 1600-1755 11765 090 GM, 1800-2155 7225 150 GM, 2200-0400 9700 255 GM. The xmsns from Wertachtal 'd've SSB PEP of 300 kW, -6dB carrier suppression (WBI 10/11)

GREENLAND After checking for many months, 3999 finally hrd again since 1/11, t/in 1017, probably *1015; rapid f/out 1027-1029, becoming one minute later per day w/LSR at both places. Woman in GL, ments of Godthab, ham QRM; 1045 ID, single pip, ham QRM worsening, but cl mx audible to 1105 (Maxfield Greenwood, Sedgwick ME, 8/11) Later had a remarkable opening, heard every note of music and every syllable of speech (Maxfield Greenwood, 19/11) The SW xmtr of Grønlands Radio at Nuuk on 3999 is at present inactive due to erection of the new omnidirectional antenna. When operating again it should be easier for SWLs in NAM to hear GR (Erik Kåie, p.t. Greenland, WRTH NL) Passing thru? Hardly a std abbr (gh)

GRENADA On 5/11, CANA mx agcy referred to a bc from 'Spice Isle Radio', which'd been monitored in St Vincent. Stn had replaced R Free Grenada, destroyed during last month's invasion (WBI 10/11) Hmm, so Grenadians no longer consider selves free?

GUIANA FRENCH Fq sked published by TDF, French controlling authority for bc xmtrs, for period starting 4th March 1984 shows this sked for new SW relay stn in Montsinery: 0900-1000 11880 9575, 1000-1100 17860 11880 9575, 1100-1200 17860 15435, 1200-1800 21580 17860 15435, 1800-2200 17860 15435, 2200-0200 15300 11790 9605. A fq sked for D83 has not been rxd and use of relay stn during this time cannot be established(WBI)

GUINEA unID on 15313 at 2015 9/11, guess Af; native mx till 2016 man speaking unk lang, covered by Paris 15315; 2038* (Chuck Oliver, Spring TX)

HONDURAS stn on 4965 around 1140, first thought Asian; not Colombian; but TC for GMT-6 at 5:45, "Esta es Comayagua Ranchera.."; ID starting with "Radio --" also hrd; Radio Landia formerly listed but "Landia" not hrd and not sure if this stn; but definitely in Comayagua. Nothing but ranchera format; in Spanish only, no Indian (Maxfield Greenwood, Sedgwick ME, 19/11)

IRAN VOIRI DS quoted Managing Dir of V & Vision of the Islamic Rep of Iran (VVIRI) as saying 23/10 that there was already a SW net, which became operational in Feb/Mar 1982, comprising six 500 kW xmtrs, 16 aerials, covering 2/3 of world. A powerful SW xmtr, purchased from Switzerland recently, 'd become opl soon. VIRI EG ES added 24/10 that 'world svc' pgms of the VVIRI 'd be increased to '25 pgms'. VVIRI was also endeavouring to increase output of AR to 24h (presumably per day). Duration of EG, GM, FR pgms 'd also be increased (WBI 27/10) VIRI anmt 25/10 said 0330-2030 AR ES now sked: 15315 0330-1300, 15084 1730-2030, 7230 1530-2030, 7215 0330-1500 + MW & FM. Monitoring reveals the ancd SW fq usage is accurate unlike MW & FM (WBI 3/11) AR svc is hrd on 11745 instead of 15315 despite anmts (WBI 10/11)

IRAQ R Baghdad Persian svc obs: 0600-1300 11775 or 11765, 9595 or 9585, 7180 or 7170, 3367. 1600-2300 9595 or 9585, 7180 or 7170, 3367(not 1900-2000). 11, 9 and 7 MHz outlets subject to constant variation (WBI 20/12) R Baghdad 9745 xmtr monitored: 1100-1425 Turkmen svc ancd, but appears to be in Turkish; 1430-1525 Turkish to Turkey; 1600-2100 V of the Masses in AR to Eu. After 2100 carries the domestic WOM svc (WBI 3/11)

ITALY Between 0700 & 0930 apx on 18/10 & 19/10, a stn mainly in IT called "R Time" hrd on 7104.7. EG anmt 0703 19/10 gave sked for Eu: 0600-1500 7105, 1500-0600 7110, 0000-2400 6145. Also said Sat & Sun on 7145. Addr: R Time, P O Box 79, 50018 Scandicci, Florence, Italy (WBI 20/10) R Europa Intl, 9420, hrd 27/9 // 97.25 MHz, so there is no doubt it comes from Italy, near the French border. Exact addr not known yet; the P O Box 1, Perinaldo is no longer valid (G Mennella, Italy, Play-DX)

JAPAN Audible here most nights I stay up late enough is AIA stn JJD, Tokyo on 10415.15950, sending "solar & Geomagnetic reports" per CFL#5, and that's what the few-making-sense alphabetics therein reflect, but the main is alphanumeric cipher. Anyone with more details on this stn and its xmsns? *0700-0750v* (David Newkirk, Seattle WA)

LEBANON V of Lebanon, pro-Phalangist; AR ID: Huna Sawt Lebnan, Sawt al-Hurriyah wa al-Karamah; English: This is the V of Lebanon, the V of Freedom & Dignity; on 6550 0415-2125, all pgms in AR except 1315-1320 FR nx, 1400-1405 EG nx, 1800-1810 FR nx, 1815-1825 EG nx. Believed to bc from Al-Ashrafiyah, first hrd 24/9-29/9/75. Xmsns resumed 22/1/76 but may've been suspended some time later. VOL hrd w/regular pgms in AR, FR, EG, and at one time Armenian & Italian since 1/77. Stn ancs this addr: P O Box 165271, Al-Ashrafiyah, Beirut, Lebanon (WBI 27/10)

Newspaper 'As-Safir' reported 26/10 that the Islamic Unification Movement in Tripoli, 45 mi NNE Béirut, 'd started expl bcs (WBI 3/11) Recent monitoring of V of Truth, supporting Progressive Socialist Party of Leb, show it's on 1080 0700-1130 & 1415+ apx (WBI 3/11) 2/11, V of Arab Lebanon, supporting al-Murabitun Independent Nasirite Movement, quoted 'security reports' that Israeli experts were strengthening radio and TV xmsn masts on the high hills of Jabal Safi--E of Jba', Jazzin hills-- and on the eastern hills overlooking Sidon and its coastal area. Techs'd installed eqp for a spl bcng stn for the local Israeli admn in S Lebanon in case the 17/5 accord was annulled. BC stn named "R 17th May" (AR: Idha'at as-Sabi' 'ashar min Ayyar') (WBI 10/11)

LIBERIA ELWA, Monrovia ES for Sudan Interior Mission stn: 0630-0700 AR Naf 11940, 0630-0845 Sat EG/Waf langs WCAf 11830, 0630-0900 Sun EG/Waf langs WCAf 11830, 1215-1315 FR/Waf langs Waf 9550, 1300-1630 Sun EG/FR/Waf langs WCAf 11830. 1630(Sat 1700)-2120 EG/FR/Waf langs WCAf 11830. 1815-1945 FR/Waf langs Fri/Sun Waf 6070; 1815-2000 FR/Waf langs Waf not Fri/Sun 6070. 2015-2115 AR Naf 11850 (WBI 3/11) DS in EG: 0600(Sun 0700)-(0802 Mon-Thu, 0817 Fri) 4765, Sun 0830-1530 6070, Sat on 4765 to 2302. Mon-Fri 1530-1757 6070, daily 1730-2302(Sun 2247) 4765 (WBI 3/11) Or something like that; as usual, BBCMS' method of presenting the info is different and rather confusing (gh)

MALI Rdif Nationale du Mali, Bamako DS sked is also very confusing; instead of showing Mon-Fri sked in one sequence, Sat in another and Sun in another, times thruout day are given w/different s/on times mixed in, some fqs used certain days only, etc. However, I have rearranged it into this: Mon-Sat 0600-1000 5995 4838 4783, 1200-1800 11960 9635 7110, 1800-2400 5995 4838 4783. Sun 0700-1800 11960 9635 7110, 1800-2400 5995 4838 4783 (WBI 3/11 & gh)

MEXICO XEUJ, Linares, on 5979 at 2120 25/10, typical Mex mx, vy good sig. XEQM, Mérida, 6105, same as above--rather hear this than R&R stuff many stns put out (Chuck Oliver, Spring TX)

MOROCCO RIM DS, Rabat, Net A in AR: 0600 11805 9865, 0700 15335 9865, 0800 17815 15335, 1100 17815 15595 15335, 1400 17595 15595 15335, 1700 17595 15335 15330, 1800 15335 15330 9865, 2000 15335 15105 9865, 2100 15105 11960 9865 (WBI 27/10) Given this way as BBCMS appears to check fqs on the hour for nx w/out necessarily specifying exact times of fq changes (gh)

NEPAL 5005 strong 14/11 thru 18/11, *1147 mx, ID, IS, ID again, charming man w/little children talking/teaching/singing in NP, recitations, giggles to 1205 nx, mx, 1220 IS & f/out. Berg thinks I shouldn't be able to hear it that late, but there it is. Different format from 9589 a couple years ago which had EG IDs; this is entirely DS; not Sibiu, Sarawak; checked 9590 but nothing besides KTWK; no carrier on 3425; on 19/11 had carrier only on 5005 which could've been Sibiu (Maxfield Greenwood, Sedgwick ME)

NIGERIA Monitoring since 13/10 shows R Nigeria testing new xmtr & fq for its proposed Educational Svc. Tests hrd on 4932 w/local timespan of 0500-2400 ancd. At times 4932 // R Nigeria Lagos on 4990 for news; Requested reports to G.M., Educational Svc, R Nigeria, Ikoyi, Lagos (WBI 20/10)

OMAN R Oman audible again on 11890, in AR to 2125*. Jamming from 11895 spread a problem but Oman came thru it. 2050 AR mx, 2100 ID, AR nx mentioning "U.S.A.". 2117 Qur'an, 2123 s/off when no ID noted. M vocal chorus, presumably NA, and quick c/off; listed 2130* (Maxfield Greenwood, Sedgwick ME, 19/11)

PERU R Nor Peruana, 9655 usually *1106, one day *1111, YL ID, Andean mx, clear chan nel w/Thai on 9650 (Maxfield Greenwood, ME, 8/11) New addr for R Imagen, per verie, is Jr, Ramón Castilla 255, Tarapoto. Verie rxd in just 641 days. Calls are OAX9M on 5035 (John Wilkins, CO) On 3704v is R Lux, not Luz as I had erroneously thot. G sig 26/10 0030, Peruvian mx, Andean & some Criollo, slogan "tu emisora preferida, tu emisora querida". Fair sig on 3910a from R Nuevo Cajamarca, 26/10 0040, Peruvian mx. M ancr w/indifferent mic mod tho mx sounds OK. Apocalyptic static crashes & bad ham QRM. Also unID Peruvian on 3934v; and on 5811v--R Altiplano? R Tingo María, 4760, 4/11 0920 odd Andean pop mx w/electronic backings; several IDs & bad TCs, same level as R Inca 4762. unID on 6965 9/11 0032-0140*, vy long ballads, mddy sig, also as of 14/11, maybe Altiplano 5812-5815v, 3943 & 3142 still unID, both seem hopeless (Richard Stoller, Bogotá DE, Colombia) R Los Andes, 5030, finally QSLed 2nd report after 85 days or more. Personal letter in which they propose to start a DX pgm for foreign listeners; write soon supporting the idea. Had sent a C-10 cassette and a US greenback plus several Italian stamps. V/s Pablo Jacob Cárdenas Valverde, Dir. Gen. QTH: Jirón Bolívar 529, Oficio 201, Huamachuco (Monferini, Italy, Play-DX)

PHILIPPINES A test in JP from FEBC hrd 25/10 1031 on 9715 (FEBC is thot to've discontinued JP svc in Oct 79) (WBI 3/11)

QATAR QBS, Doha, DS in AR 0245-2130: 0245 11885 9570, 0700 21525 9570, 1300 17910

9570, 1730-2130 11740 9570 (WBI 20/10)

SIERRA LEONE SLBCorp, Freetown, DS 0558-1030, 1155-2405 (no break on Sunday), on 5980, in EG and local langs Krio, Limba, Mende, Temne (WBI 10/11)

SPAIN Since beginning of Oct, changes obs in RNE SP ES which appears to've dropped the name "Servicio Mundial" (World Service) and introed several changes to pgm times (WBI 20/10)

SURINAM AFP reported 27/10 that Surinamese mily govt'd stated that xmtrs of Surinam natl radio svc (SRS) 'd been destroyed in an attack on 26/10. Responsibility for the attack was claimed in an anon phonecall to Neth nx agcy ANP in The Hague 27/10 by a previously unk org calling itself "Down with the military dictatorship". 4850 & 725 SRS channels not monitored since 26/10 (WBI 3/11)

SWEDEN SSB relays of Swedish HS pgms P1 on 100 kW Varberg: 0630-0800 21550 0800, 0800-0930 Sat/Sun only 21550 110, 0930-1200 21555 110, 1200-1600 21555 170, 1600-1800 15435 170, 1800-2130 15420 250. Also SSB for ES on 11785 0000 2330-2400 & 0200-0230 SD, 0230-0300 EG (RS1 D83 sked) BECMS typoed 2330 to 17785 (gh)

SWITZERLAND Red Cross BCing Svc on 22/11 & 24/1: 0945 9650 15305 21695 EG; 0945 215-20 FR, 0955 21520 PT, 1005 21520 EG. 24/11 & 26/1 0945 15430 17830 21520 FR/PT/EG, 0945 21630 AR (Red Cross R, via Play-DX) I begin to wonder if these 'beamed' xmsns and the non-direxional ones on 7210 Mon & Wed of same weeks e.g. 0600-0700 incl EG Mon 0600-0630 are under same admn, as so often one set of .xmsns is listed without even mentioning the other... (gh)

TAJIKISTAN Dushanbé o/China on 4975 at 1215 w/full ID, IS; 4635 peaks eves around 0200; I misspoke on phone to gh giving 4970 which was mentd on RCI 12/11 (Maxfield Greenwood, Sedgwick ME)

THAILAND Once a DKer's dream, R Thailand is now hrd regularly, daily on 9650 tho ancd 9655; must actually be beamed toward ENAm as reported; // 11905 useless w/Taiwan et al. 9650 totally clear; audible & readable on decent days when EG starts at 1130, becomes VG after 1215, but that's tail-ending. Grows stronger in other langs, but listen for EG IDs between them, such as 1310 after Burmese (Maxfield Greenwood, Sedgwick ME, 19/11) R Thailand hrd here in EG 2330-0030; interesting pgm daily 2330-2400 "Travel Thailand" then nx, G sigs some eves on new 9650 ex-still ancd 9655. Also hrd w/G strength on 9650 in Malaysian 1300-1359 when DW takes over fq (Finn Krone, Denmark, DSWCI DX pgm on AWR Portugal 24/10 via DSWCI SW News)

V of Free Asia (VOFA), Bangkok, ES on 1575 kHz controlled by Thai Foreign Ministry: 1000-1030 Mon-Fri VOFA Domestic nx, features, commentaries in Thai. 1030-1040 Sat Laotian, 1030-1100 Mon-Fri Thai VOFA World nx, feats, comment; Sat 1040-1050 Cambodian, 1050-1100 Sat Viet. 1100-1230(Sun 1300) relay VOA: 1100-1200 EG, 1200-1230 Laotian, 1230-1300 Sun EG. 1230-1300 Mon-Sat EG VOFA Domestic & world nx, features & commentaries. 1300-1330 Thai, relay R Thailand DS nx. 1330-1700 relay VOA: 1330 Cambodian, 1400 Burmese, 1500 Laotian, 1530 EG, 1600 Bengali. 2200-2230 relay VOA Cambodian (WBI 27/10) Megawatt can make it to WNA

UKOGBANI Weekend Music Radio, test xmsns to the world for the winter: 27/11 0200-0800 on 6260 & 6235 (or 6280), two in //. Other dates will be 11/12/83, 8/1/84, 24/1, 12/2, 26/2. Xmtr is about 40 w and 30 w but possibly 6260 will use 100 W one time. Hope you all log the 0200 xmsn (Jack Russel, WMR, 42 Arran Close, Cambridge, England) Too late here for first one, but publicized on RCI a week before (gh) R East Coast Commercial hopes to be on 26m again soon, operating Saturdays: first & third of month on 7317, 2nd & 4th on 11586, 5th a well deserved rest. DX pgm on 1st & 2nd. Two mailing drops: P O Box 319, Edenbridge, Kent; but 32 Victoria Rd, Salisbury, Wiltshire SP1 3NG, works better (Neal West, DSWCI SW News Nov)

U S A After trying it two weeks, WRNO decided against keeping pgms at same CT instead of GMT, and resumed GMT scheduling, so World of Radio is now: GMT Sat 0530 on 6185, GMT Sun 0230 6045, Sun 1400 on 9715. A new stn carrying World of Radio is WQFS 90.9 FM, Greensboro NC, Fridays at 3 and 9 pm ET; others are WPKN 89.5 Bridgeport CT Sats 4:30 pm ET, WPTF 680 AM Raleigh NC Mon 3:09 am ET; and KUWR 91.9 FM Laramie WY Sats 7 pm MT (gh)

RGEI D83 Asian svc on 6100 0930-1230 250 kW, first two hrs in RS, rest JP (RA DX)

U S S R On Sats, RS-lang xmsn 0815-0900 from Pac Ocean R Stn (Radiostantsiya Tikhly Okean) in Vladivostok contains mx in EG 0847-0852; hrd recently on 21530 17870 17860 11750 9620 9600 7320 (WBI 27/10) Special Nx bulletins for PolAr Regions: Mon 1030-1100 on MIA fqs to Eastern Sector of Arctic; Mon & Wed 1500-1530 on 9590 & 9490 to W Sector of Arctic and Antarctica. TASS Dictation Speed BCs for domestic local nxpapers: 0700-0900 Mon-Fri 9850 9730 7420 7340 6770 5780 (WBI 3/11)

7/11, R Moscow coverage of Red Square parade commemorating 66th anniv of Great Oct Socialist Rev consisted of live reportage in RS for listeners at home & abroad. Commentaries on the parade were also bc in Std Chinese, FR, EG for ES audiences. First time since 1978 that bc in FR. Russian audible on total of some 78 SW channels between 5900 and 21750, began at 0650, ended 0900. RMWS carried parade in EG 0650-0813 on 37 SW channels; FR lang R Moscow Intl 0650-0815 on 16 fqs to 0900 w/mx. Std Chinese hrd in UK & ME 0650-0900 apx on 6 SW fqs (WBI 10/11)

Monitoring shows Soviet radio introed winter SW fq sked 1/11; two EG xmsns 1630-1700 from R Stn Peace & Progress--one to Af on 11715 11690 9745; other As/ME 7305 6170 1314. RSP&P to As 1530-1600 not hrd since end of Sept, but continues to As 1300-1330 on 15330 11845 11710 (WBI 10/11) Since 1/10, RSP&P monitored in EG: 1300-1330 11845 11925 12065 15515 17740 17765 21585 21725; 1630-1700 As 1071 6120 7165 9730 9750 11755 15175; 1630-1700 Af 9530 11715 11690 12000 15490 15520 (NDX, Japan via WRTH NL)

VENEZUELA R Mundial, Caracas, 5050, reactivated 29/10 & 30/10 0330-0430, terrific sig, local level (V de Tomasi, Claudio Dondi, P Cotroneo, Italy, Play-DX) R Mundial, 5050, Caracas is back! First noted 30/10 0353-0500+, pgming mostly folk mx, US pops, slogans of "YVKE Mundial!"; RTTY knocked it out at 0430 but still readable on LSB; following nites Lam sig u/RTTY considerably weaker (Nolan Stephany, Williamson NY) R Mundial, Caracas, reactivated 5050, hrd nitely since 4/11 w/YV vocals arnd 0700-0830, TCs after each sel & fqt IDs for "YVKE Mundial!"; full ID 0800 "Desde Caracas, capital de Venezuela, YVKE Mundial con mil vatios de potencia musical!"; lottery results from Zulia and Táchira, list of all-night pharmacies, otherwise very few ads. G signal here (John Wilkins, CO, 8/11) R Mundial, 5050, 9/11 0135 w/YV fútbol, M reading winning lotería numbers, etc. F/G sig in absence of distorted glob Yopal. I didn't know this was still arund! (Richard Stoller, Bogotá DE, Colombia)

CLANDESTINE CRANNY R Liberté, a new cland, appears every Sun & Wed on 9610 to Haiti, in Creole w/ID in FR, 2100-2200 & repeated at 2300-2400 (Frantz Volton, Martinique, Nov DSWCI SW News) I wonder if that's actually a Moscow pgm; latest BBCMS survey of RM not in yet (gh)

Liberty The Nov Popular Communications (via Jack Widner, IN) contains an article on Liberty by Don Jensen. Among other things, it states "One Canadian, with a straight face, interpreted an ambiguous remark by Liberty to mean she was broadcasting from Ottawa. A critic later observed that the improbable interpretation did result in the Canadian monitor being interviewed by a couple of his local TV stations". Aside from this obviously dishonest attack on CMS, and not explaining why Liberty made her bizarre Canadian claim in the first place, Jensen writes that Liberty was a television newscaster named Silvia Fernández Barito and that "Argentine broadcasting insiders confirmed that the stn indeed broadcast from a secret xmtr at a military base in the northern part of the country". All of which might be absolutely true, but one would be inclined to take Jensen's claim of reliable inside sources much more seriously had he explained and identified the crossmodulation -both with another Argentine bc stn and a jammer - so often hrd on Liberty's xmtr. On the other hand, one must take this article in the overall context of contemporary cland bing, what is being written about it, and who is publishing these articles (C M Stanbury II, SWNS)

R Free Surinam, hostile to govt of Surinam, hrd 0106-0135 16/10 on fq varying arnd 6905; not traced agn til 20/10, when found back on 6850 (WBI 27/10)

R Mambi, 7076, sent QSL via prepared stamped card from Junta Patriótica Cubana, Box 350-492, Riverside Stn, Miami FL 33135. Hrd 2358-0011 (Ralphus W Perry, USA, Play-DX, Italy, 31/10)

LV del CID pgm hrd on R Táchira, San Cristóbal, 4830, 22/10 0105 ('RPA', Play-DX, Italy) Interesting; same time previously--still?--on Ecos del Torbes 4980 (gh)

R Venceremos from 11/10 resumed 1-hr bcs 0000; repeated 0230 1215 1830 Mon-Sat; 1400 & 2000 Sun. Currently hrd on 6800 & 6725 (WBI 27/10)

October Storm Radio /China. In a nx report 1/11, V of Vietnam quoted info which it said came from clandestine station of this name which'd recently started in China. VOV said a bc from the stn 20/10 'd been hostile to Deng Xiaoping (WBI 10/11)

Kawthulay Radio As reported last month, stn tested 22/10 & 23/10 0030-0150 on 9775. In Sgaw and Pwo Karen 0030-0130, in Burmese 0130-0140, EG 0140-0150. EG segment, addressed 'to all Karen natls and the entire people of the country' and that the test'd be made twice a week, Sats & Suns, 0030-0200 (WBI 27/10)

V of the Tamil State In a report from New Delhi 6/11, AFP reported that xmsns from this new stn, possibly from somewhere in Sri Lanka, 'd been picked up in Madras. AFP quoted the United News of India (UNI) that an inaugural bc 4/11 'd opened with the song "Love Live Tamil State" (Tamil: Vazhgha Tamil Eelam). UNI said SL Tamils in Madras'd indicated stn'd been set up by a militant youth organization calling itself "People's Liberation Organization of the Tamil State", using equipment bought from W Germany. Exact location of stn, on 4lmb, unk, but Tamils in Madras said it was not on Indian terr. Report in Dubai-based newspaper Khaleej Times, 8/11 said SL Govt'd ordered navy & air force to scan the Indian Ocean to track down a mystery ship which has been being illegal radio pgms. First pgms'd been upicked in SL & S India on 4lm 6/11, began w/EG & Tamil songs supporting separate Tamil state in SL. Per Khaleej Times, SL gov't believed eqp used to xmit pgms was of W German manufacture and was extremely powerful. Had IDed as v of a separate Tamil State in SL. Said pgms'd be bc weekends for two hours and promised being hours'd be extended (WBI 10/11)

Free Voice of Iran (Persian: Seday-e Azad-e Iran), hostile to Khomeyni and his followers, on constantly varying fqs 0300-0400 Persian; 1500-1550 Persian and irregularly in Azeri, on 11765 9585 7180 3367. First hrd 29/5/80; thru facilities of R Baghdad, Iraq (WBI 20/10)

V of Iraqi Revolution, 7006 kHz, hostile to Iraqi govt, favouring Kurdish autonomy, and that from 30/10, AR at 0400 will be retimed to 1230 (WBI 3/11)

V of Palestine, 3925, in EG w/a somewhat yankee accent, hrd 31/10 1645-1740*, P-G. No idea from where--Lebanon? (V De Tomasi, Italy, Play-DX) Euro pirate shenanigan?

V of Palestine / Lebanon / V of the Palestine Revolution. VOPVOPR, 1412 kHz, supporting Yasir Arafat, abruptly went off the air w/out explanation 0617 3/11; but 0848 5/11, unID stn on 1412 hrd playing recordings of pop AR mx; operated intermittently til 1115; hrd same day 1730-1930. The unID returned 6/11, 7/11, 0500-0700 apx; again 7/11 *0750, ID as "V of the Palestine Revolution, V of the Palestine Liberation Organization" (Arabic: Huna Sawt ath-Thawrah al-Filistiniyah, Sawt Munazzamat at-Tahrir al-Filistiniyah). Brief talks bc by stn at 0850, 0900, 0912 indicated it was now carrying material hostile to Yasir Arafat. 0908 also IDed as "VOP, VOPLD, V of the Palestinian Natl Unity". Continued most of the rest of the day. 8/11, VOPR hrd 0505-0535, 0700+; 0752, told listeners it was the voice representing Pal natl unity. Xmt from Turbul from the radio the "Arafat mercenaries" left behind, from same place, same means, same eqp. R Lebanon reported 3/11 that residents of Tripoli and vicinity had woken up that day at 0300 to sound of artillery shelling and explosives. Violent battle'd begun between the Abu Musa Pal forces and the pro-Arafat forces. Initial reports stated that Abu Musa forces were able to take control of several positions in the area, incl VOPR, which stopped xmiting at 0620 (WBI 10/11)

Our Radio / V of the Communist Party of Turkey 3/11 until 1400, these stns which share a xmt'r believed to be in the GDR, operated jointly to carry a spl pgm on the 5th Congress of the Communist Party of Turkey. After 1400, OR & VOCPOT carried their own separate pgms (WBI 10/11)

V of Sudanese Popular Revolution, 17940, 9/11 1705, native mx, on and on; good S5 sig (Chuck Oliver, Spring TX) ID? Presumably from Libya

NORTH AMERICAN PIRATES V of Democracy hrd 1/11 on 7415 w/ SINPO 23222 but good audio. 0353 anc'r ment'd phone 212 283 9977, and "the greatest country in the world", then "live xmsn from the USSR" but nothing happened. Played IS (last 2 bars of NA on organ) w/ID repeated several times. Then tried again for 'live xmsn' but anc'r ment'd "technical difficulties" until 0400 when the 'xmsn' came thru, a commentary on the Beirut bomb-

ing (RM spoof), t/out 0402 (Travid D McLemore Jr, Clearwater FL)

Jolly Roger Radio noted w/good sigs on 12040 1/11--Halloween night NAM time--in Indianapolis until abruptly leaving the air at 0233 due to tech problems (Jack Widner, SWNS)

R Clandestine, 4889.5a, 4/11 0435-0506*: usual pgm of raucous rock tunes, R. F. Bumms w/canned slogans, and a test of the Universal Spaceship and Flying Machine Imperative Locator; G sig, but lots of QRN, no QRM; s/off w/out fanfare 0506 (John Wilkins, CO)

KPRC, 6280, 10/10 on at 0501 past 0545 taking phone calls from WDX who said they'd be back around Thanksgiving on 1620, NYC, Ohio, and Jackson Heights NY. Sig sounded like trans [? -gh] because of QRN. KPRC on 1616, 24/10--the evening of the bombing in Beirut--44444, *0230 w/"Who's afraid of the Big Bad Wolf" followed by a statement by host Pirate Joe that Ronnie Reagan was the b.b.w. Several IDs hrd, along with well-done jingles. Many war protest songs played and he said millions of people should demonstrate so the US will pull out of Lebanon. At 0332 phone calls taken to 212-352-9906 w/calls from Jackson Hts NY, Williamson NY--guess who, Ohio, Colombia [sic] Crossroads PA; Pirate Mike of WDX; Wilmington DE, Montreal PQ, Burlington VT, Ottawa & Toronto Ont. At 0530 he played the famous parody of "electric Avenue" called "Stupid Avenue" which I had requested. Also claimed to be on 6280 SW (not hrd) and 91.5 FM stereo. Gave Exeter.NH addr (Nolan Stephany, Williamson NY)

Free Radio Directory, Third Edition, Dec 1983, (C) 1983 John T. Arthur. These are known mailing addrs of recently active NAM Free Radio Stns, accurate to 15/11/83. In an attempt at completeness, this list includes some inactive stns, but those inactive for more than one year have been purged here. Entire list published in December ACE.

Box 144, Riverside NJ 08075: KHO

*=known to be inactive or busted...

Box 245, Moorhead MN 56560: WDX-1620, KMJC, New Wave Radio Intl, The Crystal Ship

Box 302, Levittown PA 19057: WRAM*

Box 747, Exeter NH 03433: KPRC-1616

Box 982, Battle Creek MI 49016: WOIS, WOOF*, WPOT-1610*, KTGR, Radio Alpha Corona*, Radio Amity*, Radio Clandestine, Radio Confusion, Radio Free Wombat, Radio Flying Dutchman, Radio Indiana, Radio Laryngitis, Radio Northstar International*, Radio Paradise International, Radio Toronto*, Radio Xenon*, Voice of the Pyramids, Voice of Sincow.

Box 5074, Hilo HI 96720 (formerly Box 4948, Arcata CA 95521): KCFR*, KFAT-1560, KMTL-750, KQSB, Radio Free San Francisco*, Radio USA.

Box 40554, Washington DC 20016: Pirate Radio New England.

When contacting a Free Radio station: (1) Use the addr announced on the air; if none is ancd, try the one listed above. If all else fails, send a report to one of the main maildrops and hope for the best; allow longer for additional forwarding, of course. (Note: Many stns can be reached thru other addrs than these; some stns that no longer operate can be reached thru Battle Creek, e.g. KVHF. Some older boxes may be closed, w/no forwarding addr on file at the PO).

(2) Enclose adequate postage for forwarding and reply; three 20c stamps will cover everything. Do not expect a maildrop to pay for your QSL! Remember that announcing a maildrop is NOT guaranteeing anything; there are other reasons to want audience contact. And don't blame the maildrop if you never get a QSL. We are not QSL managers; we simply forward mail; the Operators are supposed to live up to the '100% QSL' promises they make.

Stns are requested to confirm addr info and active status prior to 1 May 84 for inclusion in the Fourth Edition, to be published in June 1984. Reader additions and corrections are also solicited; send all input to Box 5074, Hilo HI 96720. This list may not be reproduced for commercial use w/out written permission from the author. Non-profit use unrestricted (John T Arthur, HI)

UNIDENTIFIED

15008 Timesig stn hrd at 1300 18/10, lang in Chinese or Japanese by woman,

time pips similar to YVTO (David Swaringen, NC)

11395 Arab stn at 1910 1/11, M speaking until 1915, then flute notes followed by a shout about America, mention of Khadafy; AR mx, 1928 mil mx, short slogans(?) My guess is Libya (Chuck Oliver, Spring TX) Or cland V of Libyan People

7430, 1/11, SINPO 34323, t/in 0250 w/"Devil Woman" by Cliff Richard, "Rhiannon" by

Fleetwood Mac and "Swamp Queen of New Orleans". At 0257, what sounded like an anti-rock preacher came on and mentd "and around and around..." but w/poor audio. 0300, hrd part of a movie soundtrack ("...aliens have reached Chicago south side and suburbs..") and a mortar's[?] version of nursery rhymes set to 50's mx. Supposed ID at 0303 "...WCFE, Pelham, Mass." (checked the Broadcasting Annual Directory, but it didn't exist in the 1982 edition, so must be new stn). Peter Gunn theme followed, accompanied by screams, dogs barking and dogs howling. Another ID at 0309, then "Riders of the Storm" by the Doors w/same sound effects. F/out 0313. Probably R Clandestine, or R USA? (Travis D McLemore Jr, Clearwater FL)

7415_0, The Laugher; Pirate? 29/10 & 3/10 0413-0430* & 0325-0331* respectively. SINPO 55555 & 45433 resp. Was a continuous tape loop of a man laughing/haunting, much similar to those mechanical clowns in fun houses at amusement parks, for an IS, followed by a chant (kind of weird) on the Funny Farm, which was quite pro. Note the s/off times change with the local time so came undoubtedly from USA/Canada. On 31/10 GMT, southern condx enhanced so sigs weaker. My guess is this came from Willard Psychiatric Center, Willard NY (hi). Like a tape? (Nolan Stephany, Williamson NY)

6800, 22/10 0325. Strong carrier but vy weak mod. Spanish, couldn't make out anything; 0335, excerpts from "Ave Maria", then F anc (Chuck Oliver, Spring TX)

4901, tremendous het w/Juventud noted already at 1045, 1050. Juv generally holds strong to 1140--past their sunrise; now done in by 1110; unthink it's Indo; CAM likely; seems to be M & W in EG and SP (Maxfield Greenwood, Sedgwick ME, 19/11) Lang mix reminds me of Mosquitia--move from 4910? (gh)

3000 & 2850. From 2205 tune in past 2215 9/11, two clear oriental sigs--2850 probably Pyongyang tho lang sounded more like Chinese than Korean, but we're no expert on orlangs. 3000 had what we thought was Chinese mx until 2210, then M & W w/commentary. Conceivably Pyongyang's foreign svc ex-3015. No trace of either sig the following nite (C M Stanbury, II, Ridgeway Ont, SWNS)

PUBLICATIONS Broadcasts in English Audible in North America, based on Oct RIB listing by time, but updated as recorded by David Newkirk, is now available on tape for the blind, in standard Library of Congress 4-track cassette format, both with tone and voice indexing. Is recorded on 3 sides of two C-60s; cost is \$5 from Northwest Foundation for the Blind, 5250 Rainier Ave. S., Seattle WA 98118 (Stewart Russell, WA)

Review of International Broadcasting, the magazine for shortwave listeners, includes in the November issue--cover photo of KFBS Saipan; Report from Paraguay by Tony Jones, a Brazilian survey by frequency, plus Bolivian and other observations; Radio Equipment Forum, edited by David Newkirk, on the RV75 VFO to relieve Drake R7 drift; notes on the ICF-2001; comparison of the Uniden CR-2021 and the Realistic DX-400. They Said it About Lech Wałęsa's Nobel Peace Prize, by Mark Schlesinger. Listener Insights on Programming--reviews and program schedules on Australia, Austria, Brazil, Canada, China (including Beijing feature topics for December), Czechoslovakia, Ecuador, West Germany, Hungary, Ireland, Italy, Japan, Malaysia, Nepal, Norway, Paraguay, Peru, Spain, USA. Complete BBC programming for December including Christmas specials. 5-page DX-Listening Digest similar to LN main section w/largely unduplicated info. 1-page Report from Peru by Juan Carlos Codina; and more. Samples are offered only for the purpose of introducing potential subscribers to the magazine; repeated orders for individual copies are not desired! Samples are \$1.25 in North America; \$2 or 7 IRCs elsewhere. Subscriptions are \$15 in North America (i.e., USA, Canada, Mexico, US overseas possessions, APO & FPO) by first class; \$20 to Caribbean, Central America, Venezuela & Colombia; \$22 to rest of South America, Western Europe, North Africa; \$24 to rest of Africa, Europe, USSR, Asia, Pacific, by airmail. Remittances must be in US\$ and on a US bank w/standard US magnetic banking code imprints; or by international postal money order. Prices valid through 1983. Order from R.I.B., Box 6287, Knoxville, TN 37914, USA (gh)

Directory of World Band Radio, gh's introductory book on shortwave listening, has just been published in its revised 2nd edition, by Sony Corporation of America. Check with your Sony SW dealer for a copy, list \$7.95. It should also soon be available through Sony's Kansas City address previously publicized, tho the part number, which must be specified when ordering, will probably be different from the 1st edition. We hope to have details on how to mailorder it next month. In the meantime, info from Chris Davis, Sony Corporation of America, Sony Drive, Park Ridge NJ 07656. The 128-page softbound book emphasizes programming, with schedules by country, time and frequency; intro to propagation; glossary of abbrs. and SW/DX terms, and much more (gh)

1984 World Radio TV Handbook The 1984 WRTVH will be published in Jan. or Feb. 1984 and retail at \$17.50 in the US; orders are being taken at \$15 USPS book rate, worldwide, or United Parcel Service, US only (please specify) or \$16 first class mail, US only. Calif. residents must add 6% sales tax. Orders, with an SASE for confirmation of shipment, and a check or money order in \$US on a US bank, payable to CENTURY PRINT SHOP, should be mailed as soon as possible (no deadline) to: Century Print Shop, Don Erickson, 6059 Essex St., Riverside, CA 92504-1599. Inquiries welcome, (714) 687-5910. In Canada, please include \$21 fourth class or \$23.50 special delivery and mail orders for receipt no later than Jan. 7 to: Canadian International DX Club, Don Moman, 6815 12th Avenue, Edmonton, Alberta, Canada T6K 3J6 (Don Erickson)

LAST-MINUTE INFO BANGLADESH R. Bang, heard at *1355 w/IS, some days much better than others depending on Peking(?) QRM, varying 11946-11945, usually closer to 11946. Usually stronger than China, and ECSS/USB gets it. Very good 19/11, no ECSS needed; YL ID believed to be in Urdu (Maxfield Greenwood, Sedgwick ME)

BELGIUM I arranged with pirate KBC to test for North America on 27/11 at 0500-0600 on 6262; they tested last year on this fq, and were logged with fair signals by me and several others. KBC's xmtr operates from a location in Belgium; however, reception reports can be sent to KBC, Box 725, Arnhem, Netherlands. This station is an excellent verifier and also produces an informative newsletter, "Goed Nieuws", every month detailing listeners' reports and other pirate broadcasting activity (William J Martin, Wilmington DE) RCI listeners were tipped off about this in time (gh)

BRAZIL At first seemed to be a new stn on 4750, strong, frequently mentioning Amapá; Christian fundamentalist pgms, as early as 2105--remember how far east I am--17/11--not Bertoua or Luanda wandering. Strong at 2110 and Cuiabá was very strong by 2210; but this one gone by 2200 when nat'l pgm'd've //ed as Brazil. Checked 0910 18/11, & also in w/religious mx in PT, EG, PT preaching, refs to Amapá; sunset is currently at the same time in Amapá and Sedgwick, so there's a gray-line path. However, stn on 4750 at 0215 20/11 seemed to São Luiz, Maranhão, down from 4755 (Maxfield Greenwood ME)

NEW SHORTWAVE SCHEDULE PUBLICATION

A new softbound 200-page computer printout of shortwave broadcasting schedules will be published in December and made available to individuals, international broadcasters and research organizations in January 1984.

Titled RADIO DATABASE INTERNATIONAL, the printout is designed to provide a convenient reference source to frequencies in use, target areas, and schedules of all shortwave broadcasters between 2.3 and 30 MHz.

The presentation will be in the form of visually-appealing computer generated bar charts that completely eliminate the need to search text material for schedules and frequencies. Key-language programs are identified by easily recognizable symbols.

RADIO DATABASE INTERNATIONAL is being developed by International Broadcasting Services, Ltd. and compiled/edited by Larry Magne. The editorial staff of RDI includes world-reknown SWL's such as: Sarath L. Amukotwa (Chief African Monitor), Victor T. Goontilleke (Chief Asian Monitor), Noel R. Green (Chief European Monitor), Don Jensen (Tropical Bands Editor), Tony Jones (Chief Latin American Monitor) and Professor David D. Meisel (Propagation Editor).

Sales and distribution of RDI will be through GILFER SHORTWAVE (a subsidiary of GILFER Associates, Inc.) A Special pre-publication price of \$9.95 will be available until 31 December 1983. The 1984 cover price will be \$11.95. A Summer Edition will be published in June. Further details on RDI available from GILFER SHORTWAVE.

52 Park Avenue, P. O. Box 239, Park Ridge, N.J. 07656 (Area Code 201 391-7887)

#

QSL REPORTS



Sam Barto
47 Prospect Place
Bristol, CT. 06010
USA



- AFGHANISTAN:** Radio Afghanistan 11960 f/d cd. in 79 ds. for 2 IRCs (required by station) xmtr-probably in Soviet Union. (Barto-CT).
- ALASKA:** KNLS 11820 f/d ltr. in 3 wks. v/s Francis M. Perry. (Barto-CT). same in 14 ds. for ms. (Orekar-CA). 6170 f/d ltr. in 37 ds. w/ various brochures and schedule. (Konen-WI).
- ALBANIA:** Radio Tirana 7120 f/d "Spirit of the Revolution" cd. in 107 ds.
- ANTIGUA:** Deutsche Welle 6040 f/d "30th Anniversary" cd. w/ site (Kapinos-MA). in 2 mo. (Lobdell-MA). same in 36 ds. (Falkenhan-MD). 9545 same in 25 ds. (Fortney-PA).
- ARGENTINA:** RAE 11710 f/d "Logo" cd. in 33 ds. (Kapinos-MA). same in 22 ds. w/ pennant and stamps. v/s Roxana Larghi. (McLemore-FL). same in 37 ds. w/ pennant. (Bruckner-NJ).
- ARMENIAN SSR:** Radio Yerevan 17900 plain white cd. in 1 mo. (Johnson-TX).
- ASIATIC RUSSIA:** Radio Moscow 12050 via Khabarovsk f/d cd. in 6 wks. (Palmerheim-MN). 17850 f/d cd. in 1 mo. (Plum-NJ). 17760 f/d cd. in 56 ds. (Fortney-PA). 11710 via Petropavlovsk-Kamchatsky f/d cd. in 71 ds. v/s Mrs. Clara Slavina. (Sharpe-CA). 12060 via Kenga f/d cd. in 56 ds. (Fortney-PA). 9580 via Blagoveshchensk w/ f/d cd. in 56 ds. (Fortney-PA). 9795 via Komsomolsk-on-Amur f/d cd. in 62 ds. (Choroszy-ME).
- AUSTRALIA:** Radio Australia 17795 f/d "Kookaburras" cd. in 43 ds. (Dillon-PA). 9580 via Shepparton f/d "Regent Bower Bird" cd. w/ sked in 23 ds. v/s Peter Barnett, Director of Overseas Services. (Blanchette-FL). f/d "Koala Bear" cd. in 38 ds. (Moore-HOND). 15160 via Lyndhurst f/d cd. in 21 ds. for 1 IRC. (Scharer-MI). VLM4 4920 f/d "Map" cd. in 3 wks. (Hazelton-WA).
- AUSTRIA:** ORF 5945 f/d "Sunrise at Moosbrunn" cd. in 74 ds. (Moore-HOND).
- BELGIUM:** BRT 9880 beautiful f/d cds. in 38 ds. (Moore-HOND). f/d "St. Michielskerk" cd. in 35 ds. for 1 IRC. (Bruckner-NJ). f/d cd. w/ sticker in 37 ds. (Bruckner-NJ). 11620 and 9880 f/d ltr. in 52 ds. (Barto-CT). 17550 and 9880 f/d ltr. in 39 ds. w/ sked. (Dillon-PA). 9880, 11620 and 17610 f/d cds in 5 wks. (Palmerheim-MN). 17610 f/d cd. in 24 ds. (Bruckner-NJ).
- BENIN:** ORTB 4870 via Cotonou p/d cd. in 6 mo. (Konen-WI). 5025 via Parakou n/d "Bariba Story tellers" cd. in 50 ds. for a FR rpt. and 2 IRCs. (Palmerheim-MN).
- BOLIVIA:** Radio Nacional 5975 f/d "La Cordillera Real" cd. in 49 ds. after a f/up rpt. in * SP in 263 ds. v/s Rogildo Fontenelle Aragao. (Streeter-NY).
- BONAIRE:** Radio Nederland 9590 f/d "Drawbridge" cd. in 13 ds. (Forman-NY).
- BRASIL:** Radio Nacional do Brasil 15290 f/d cd. in 20 ds. w/ sticker and personal ltr. for 1 IRC. (Gaffin-NY). Radio Nacional de Tabatinga 4815 f/d prepared cd. w/ personal ltr. in 10 mo. for a PT rpt. and ms. v/s Jorge Alberto Scanduzzi, Chefe do Departamento de Eng. da RADIOBRAS. (Report was sent to Tabatinga but reply came from Brasilia) (Lazarus-LA). Radio Brasil Central 4985 n/d ltr. in 22 ds. for a PT rpt. and 2 IRCs. v/s Jose Pedro * Rego, Director. (Niekamp-MN). Radio Rural 4765 p/d ltr. in 167 ds. for a PT rpt. and ms. revd. personal ltr. in EG. (Streeter-NY). Radio Aparecida 11853 f/d "Studio" cd. in 46 ds. for a PT rpr. (Barto-CT). Radio Anhanguera (ZYH691) 4915 f/d ltr. in 43 ds. for a PT rpt. v/s Maria Lucia de Brito (Barto-CT).



LA VOZ DEL CID
Cuba Independiente y Democrática

certificado de sintonia

A TERRY J. PALMERHEIM

QUIEN NOS SINTONIZO EL DIA 20 de junio de 1983

DE LAS 21.14 GMT, A LAS 21.28 EMISORA: Máximo Gómez

EN LAS BANDAS DE 25 MTS. FRECUENCIA 11,700 KHz

SUPPORT FRENCH - ITS YOUR BULLETIN...Sam



EMISORAS
GRAN
COLOMBIA

NEWS MUSIC

via Bryant and Davis & others!

YOUR QSL CARD FROM

RADIO JAMAHIRIYA

VOICE OF THE SOCIALIST PEOPLE'S LIBYAN ARAB JAMAHIRIYA

REGISTRATION DATE: 11 FEBRUARY 1976 BY: 1128 SA. 70-
 SHORT NAME: RAB 22.30 - 24.30 AND 3.1.1

ADDRESS: 400 WASHINGTON ST. BOX 19, ANNAPOLIS, MD.
 ANNAPOLIS, MD. 21403

HEAD OFFICE: RADIO JAMAHIRIYA, P.O. BOX 233, BANGOR, N.Y. 14622

OPERATIONAL HOURS: RADIO JAMAHIRIYA, P.O. BOX 233, BANGOR, N.Y. 14622

BRASIL: Radio Gaucha 11915 and 6135 f/d ltr. in 44 ds. for a PT rpt. v/s Flavio Fleck, Tecnico de Radio. (Barto-CT).

BULGARIA: Radio Sofia 9700 f/d "Mausoleum" cd. in 40 ds. w/ sked. (Dillon-PA). same in 66 ds. w/ sked. (Kapinos-MA). f/d "Kukery" cd. in 7 wks. (Plum-NJ). 11750 cd. in 55 ds. (Choroszy)

BURMA: Burma Broadcasting Service 4725 large f/d cd. in 8½ mo. for 2 IRCs. (Lazarus-LA). * same in 10 mo. (Huniwell-NJ). same in 262 ds. for 2 IRCs. (Konen-WI). What happened? Someone must of stumbled over the reports...Sam.

BYELORUSSIAN SSR: Radio Minsk 11735 f/d folder

* cd. in 69 ds. for 1 IRC. (Palmerheim-MN)...Not reported too often...Sam.

CAMEROON: Radio Douala 4795 "Map" cd. in 80 ds. for a FR rpt. and 2 IRCs. Site on reverse. (Sizer-CT). Radio Bertoua 4750 EG form ltr. in 50 ds. for a FR rpt. and 2 IRCs. v/s James Achony-Fontem. (v/s wants cash or cheques!) (Sizer-CT). same in 81 ds. for an EG rpt. and \$1.00. (Reinstein-FL). **CANADA:** CFCX 6005 p/d "Montreal" cd. in 27 ds. for 1 IRC. (Forsgren-WI). CFCX 6070 f/d "Twin Comanche Traffic Planes" cds. in 28 ds. for 1 IRC. v/s Clive Eastwood. (McLemore-FL). CHNX 6130 f/d cd. in 25 ds. w/ stickers. (Dillon-PA). same in 12 ds. v/s Kurt Arsenault. (Reinstein-FL). CFVP 6030 f/d "Calgary" cd. in 2 wks. for ms. (Florian-IL). Radio Canada International 5960 f/d cd. in 15 wks. (Mayer-PA).

CANADA: As you no doubt have noticed the Canadian QSLs are under Cameroon. It was just too much to write-off. This is the first time in many, many years that this has happened. Please bear with me. I'll get the hang of this column sooner or later...Sam.

CANARY ISLANDS: REE 15365 via Tenerife f/d "Sorra" painting cd. in 30 ds. (Cones-VA). 15345 f/d w/ site "Los Marineros" cd. in 51 ds. for an EG rpt. (Stephany-NY).

CHAD: Radio Moundou 5288 long FR ltr. in 50 ds. for a FR rpt. and 2 IRCs. v/s Dorong Guela * Ketchoua, Director. 2.5kws! Addr: B.P. 122. (Sizer-CT). 5286 ltr. in FR in 59 ds. for a FR rpt. and 2 IRCs. (George-NC).

CHINA, PEOPLES REP: Radio Beijing 17855 f/d cd. in 35 ds. w/ pennant. (Dillon-PA). 15520 f/d "Girl w/ Horse" cd. in 63 ds. w/ pennant and stickers (Stephany-NY). f/d cd. in 32 ds.

(Choroszy-ME). f/d cd. in 21 ds. for ms. (Kapinos-MA). 11505 f/d cd. in 73 ds. (Barto-CT) 4760 f/d "Great Wall" cd. w/ stickers and bookmarks in 3 wks. (Florian-IL). CPBS 7504 f/d cd. in 21 ds. (Kapinos-MA). 6790 f/d cd. in 21 ds. (Kapinos-MA). Hunan PBS 4990 f/d cd. in 28 ds. w/ pin and stickers. (Palmerheim-MN). Xinjiang PBS 4735 Urumqi f/d cd. via Beijing in 3 wks. for 2 IRCs. (Lazarus-LA).

COLOMBIA: La Voz de Los Centauros 5955 n/d cd. in 37 ds. for a SP rpt. and ms. (Niekamp-MN). Radio Macarena 5975 f/d cd. w/ personal ltr. and stickers in 58 ds. for a SP rpt. and ms. v/s Enrique Zambrano Nieto, Gerente. (Niekamp-MN).

* Armonias del Caqueta 4915 n/d cd. in 50 ds. for a SP rpt. (Moore-HOND). f/d cd. w/ ltr. in 28 ds. for a SP rpt. and 1 IRC. v/s P. Alvaro Serna Alzate. (Konen-WI)

* Radio Bucaramanga 4845 n/d personal ltr. in 60 ds. for a SP rpt. and ms. Poster rcvd. v/s Javier Giraldo Marulanda, Director and Jorge Serrano Rueba, Gerente.

COSTA RICA: Radio Reloj 4832 f/d "Logo" cd. in 16 ds. for a SP rpt. (Plum-NJ). and 1 IRC. v/s Francisco Barabona G. (Cones-VA). p/d cd. in 13 ds. for a SP rpt. and 1 IRC. (Forsgren-WI).

* Radio Impacto 6150 n/d ltr. in 4 mo. for a SP rpt. and 2 IRCs. Sticker rcvd. v/s Herberth Vasquez V., Announcer. (Plum-NJ). same in 110 ds. for an EG rpt. and 1 IRC. Sticker rcvd. (Swaringen).

CUBA: Radio Habana Cuba 11760 f/d "La Fuerza Fortress" cd. w/ personal ltr. in 4 mo. for 1 IRC. (Niekamp).



AN EXTENSIVE NEARLY TWO-THIRDS OF THE INHABITED GLOBE

WEST

-WORLD-WIDE-BROADCASTING

HATHERLY BEACH SCITUATE MASS U.S.A.

W R U L

YOUR REPORT

Feb 22 1957 15230 Kc

RECEIVED. THANK YOU.

ISSUED TO: Ronald Luyster

Radio Colosal

VERIFICATION SIGNERS: Radio Tingo Maria 4760 Leonidas Infantas Guerra. Radio Chota 6296 Mauro Vasquez Gonzales or Jose Guzman Perez Cabrera, Administrador. Radio Victoria 6025 Juan Ramirez Lazo. Radio San Martin 4810 Juan Miguel Chong Torres. Radio Pampas 4854 Luis F. D. Mestre R., Administrador. Radio Avaviri 5035 Benjamin Infantas Aragon. Radio Comercial Esmeraldas 3284 Mario Aurelio Liberatto Alfonso. Ondas del Titicaca 4922 Jose Luis Lescano Palomino, Gerente. Ondas del Huallaga 3330 Flaviano Llanos Malpartida. Radio Cobriza 2000 4926 Humberto Saipaco Salazar. Radio Cultura Amauta 4955 Vicente Saico Tingo. Radio America 3240 Hugo Salas Vera. Radio Phnom Penh 11937 Som Kim Suor, Head of Foreign Service. Radio Delmare 6205 Del Mare Johan. Radiodifusora Acreana 4885 Eduardo Jorge George Barbosa, Director. Radio Federacion 4960 Luis Mario Katan, Locutor. Radio El Espectador 11835 Jorge Cubilo, Director. Radio Itatiaia 4805 Juanuario Carneiro, Director. Radio Douala 4800 Nsima A. Radio Cinco 5040 Stella Cifuentes Riano, Secretaria. Radio Cuarto Centenario 5030 Carlos Eduardo Aparicio Hinojosa. Radio Ichilo 5076 Marcelo Huanca Dorado, Artístico Director. Emisora Rural Santarem 4765 Dom Tiago Ryan Vescovo de Santarem. Radio Lux 4890 Jaime Reinel Espinoza, Director. Radio Valles del Tuy 6129 Francisco Juari Pedro, Gerente. Radio Sur Colombiana 5010 Maria Christina Andrade de Pena, Gerente. Radio Andina 4996 Fernando Cruz M., Director-Gerente. Swazi Music Radio 4980 Bill Cookson, Chief Engineer. DYBS 6005 M.S. Moosa. KNLS 9690 Francis M. Perry, Director of Engineering. Radio Educacao Rural 4755 Bel. Ailton Guerra, Gerente. Radio Moundou 5286 Dorong Guela Retcheua. Radio Andina 4996 Fernando Cruz m., Director-Gerente. Radio Truro 6155 Mrs. Zena Watkins, General Manager. Radio Tachira 4830 Desiree Gonzales, Jefe de Relaciones Publicas.

CZECHOSLOVAKIA: Radio Prague 5930 f/d "Costume" cd. in 37 ds. (Dillon-PA). 7345 f/d "Wallachian Open Air Museum" cd. w/ slides in 35 ds. (Scharer-MI).

DJIBOUTI: Radio Djibouti 4780 B&W "Logo" cd. in 2 wks. for 1 IRC. (Johnson-TX). same in 21 ds. for a FR rpt. and 2 IRCs. (Krueger-FL). same in 19 ds. for a FR rpt.

* (Reinstein-FL). p/d cd. in 3 wks. for a FR rpt, tape and 4 IRCs. Power 20 kws. (Matthews-OH).

DOMINICAN REPUBLIC: Radio Earth 11700 via Radio Clarin f/d

* "Curacao" first day broadcast cd. in 5 mo. for 2 IRCs. (Hosmer-MI). same in 151 ds. w/ sticker for 2 IRCs. (Streeter-NY). same in 4 mo. for 1 IRC. (Konen-WI). Radio Maximo Gomez 11700 via Radio Clarin

f/d prepared cds. in 28 ds. v/s Pablo Pena, Secretary of Information. (Krueger-FL). Radio Frank Pais 7400 / Radio Antonio Gutierrez 7351 and Radio Ignacio Agramonte 5105 f/d prepared cds. in 28 ds. via the Chicago CID address. (Krueger-FL). Does anyone have any ideas of where these transmitters are located?...Sam.

ECUADOR: HCJE 9745, 11740, 15155 and 21477.5 f/d cds.

in 31 ds. for ms. (Stephany-NY). 11740 and 15115 f/d "Communications in Ecuador" cd. in 39 ds. (Barto-CT). 6130 and 9745 f/d cd. in 30 ds. (Link-CA). HD21QA 7600 p/d cd. in 120 ds. Pennant and stick er rcvd. (Kapinos-MA). f/d "Sundial" cd. in 78 ds. w/ pennant and sticker for an EG rpt. and IRC. (Mayer-PA). same w/ pennant in 76 ds. for a SP rpt. and 2 IRCs. (Konen-WI). Radio Paz y Bien 4820 f/d cd. w/ personal ltr. and pennant in 53 ds. for a SP rpt. v/s Enrique Pesuntez G., Gerente. (Moore-HOND).

EL SALVADOR: Radio Venceremos n/d ltr. in 202 ds. for a SP rpt. and ms. (not used) (Fortney-PA).

ENGLAND: BBC 9590 n/d "Bridge" cd. in 84 ds. (Forsgren-WI).

EQUATORIAL GUINEA: Radio Malabo 6250 personal ltr. in 1½ yrs. for 3

IRCs. v/s Matias Ovono Engongs Nsang. (Orekar-

EUROPEAN RUSSIA: Radio Moscow 12060

CA) via Kenga f/d cd. in 6 wks. (Palmerheim-MN).

5905 via Ryazan f/d cd. in 1 mo. (Plum-NJ).

11965 via Kazan f/d cd. in 1 mo. (Plum-NJ).

15260 f/d "National Economic Exhibition" cd.

in 57 ds. (Purdum-MI). f/d cd. in 27 ds. (Choroszy-ME). 17700 via Serpukhov f/d cd. in 52 ds. (Choroszy-ME). same in 56 ds. (Fortney-PA).

FAKLAND ISLANDS: FIBS 2370 f/d cd. in 6 wks. v/s A.K.

* Davies. (Lobdell-MA). 3958 f/d cd. in 29 ds. for 3

IRCs after 1 f/up rpt. (Orekar-CA).

FEDERAL REP. OF GERMANY: Deutsche Welle 9690 via Wertachtal

f/d cd. in 25 ds. (Fortney-PA).





via Wilkins

Radio Peru

Cusco

3-8-9361

ORU

RADIO VANUATU

NATIONAL SERVICE



elit Gong (Tam Tam)

via Joe Talbot

via Tbilisi f/d "Misha Bear" cd. in 45 ds. for a SP rpt. (Choroszy-ME).

GREECE: Voice of Greece 9420 f/d "Rhodos Beach" cd. in 25 ds. (Caravan-PA). 11645 f/d "Samos" cd. in 51 ds. (Dillon-PA). same in 105 ds. (Moore-HOND).

GREENLAND: Gronlands Radio 3999 f/d "Winter" cd. in * 2 mo. for 3 IRCs. (Orekar-CA).

GUAM: KIWR 11840 f/d "Studio" cd. in 42 ds. w/ paper pennant for ms. v/s Beth Chich. (Stephany-NY).

HAWAII: WVVH 15000 p/d "Outrigger" cd. in 17 ds. for an EG rpt. (Caravan-PA).

HOLLAND: Radio Prie Sranan 6850 f/d prepared cd. w/ * stickers, posters on DT cover letterhead from M. Nasrullah in 26 ds. via the Holland address. (Krueger-FL)...I presume this is the Suriname station being reported recently. Is the transmitter in Holland?...Sam.

HONDURAS: Radio Luz y Vida 3250 f/d ltr. in 9 mo. for ms. v/s Don Moore. (Moore-HOND). same in 376 ds. for a SP rpt. and ms. 250 watts! (George-NC).

HUNGARY: Radio Budapest 12000 f/d "Earth" cd. in 30 ds. (Dillon-PA).

ICELAND: ISBS 13797 f/d cd. in 9 mo. for 2 IRCs. (Orekar-CA). f/d cd. in 250 ds. for 2 IRCs. (Tutak-NJ).

INTERNATIONAL WATERS: Voice of Peace 6240 f/d form ltr. in 50 ds. for ms. v/s Stuart Vint, * Engineer. 400 watts! (Plum-NJ). same in 56 ds. for 2 IRCs. (Krueger-FL). (off Israel)

IRAN: VOIRI 15084 f/d "War is Ugly" cd. in 14 wks. for 3 IRCs. (Davis-CO). 9022 same cd. in 109 ds. (Kapinos-MA). same in 62 ds. (Barto-CT).

IRELAND: Radio Dublin International 6910 f/d "Map" cd. in 68 ds. for 2 IRCs. v/s Marian Knowles. (Cassidy-IN). same cd. w/ sticker in 71 ds. v/s Gerry Jones. (Tutak-NJ).

ISRAEL: IBA 11655 f/d cd. in 81 ds. (Moore-HOND). same in 9 wks. (Wilkins-CO).

ITALY: RAI 9575 f/d cd. in 104 ds. (Kapinos-MA). same in 5 mo. for 1 IRC. (Niekamp-MN). f/d "Carlo Carra" cd. in 139 ds. (Cones-VA).

IVORY COAST: Radio Abidjan 4940 f/d "Logo/Map" cd. in 51 ds. for an EG rpt. and 1 IRC.

(Forsgren-WI). in 71 ds. for a FR rpt. (Stephany-NY). in 25 ds. for 2 IRCs. (Streeter).

JAPAN: Radio Japan 17825 f/d "Kokeshi Dolls" cd. in 26 ds. (Dillon-PA). same in 29 ds. (Blanchette-FL). 17755 n/d "Buddhist Image" cd. in 41 ds. (name?) 21640 "Danzan" cd. in 1 mo. (Palmerheim-MN).

via John Bruckner

ISRAEL RADIO LA VOIX D'ISRAEL LA BOZ DE ISRAEL ГОЛОС ИЗРАИЛЯ



KOL ISRAEL QSL

LA VOS DE ISRAEL IZRAEL HANGJA A VOZ DE ISRAEL VOCEA ISRAELULUI



via John Wilkins

KAMPUCHEA: Voice of the People
 * of Kampuchea 11938 f/d "Galerie d'Angkor" cd. in 16 mo. for an EG rpt. and 3 IRCs. v/s Som Kim Suor. (Davis-CO). f/d ltr. in 10 mo. w/ XMAS cd. (Leite-MA). in 30 ds. for 1 IRC. (Swaringen-NC). 9695 f/d ltr. in 27 mo. (Kapinos-MA).

KAZAKH SSR: Radio Moscow 11770 via Alma Ata f/d cd. in 55 ds. (Purdum-MI).

KOREA, REPUBLIC OF: Radio Korea 9750 f/d "Family Reunion" cd. in 55 ds. (Barto-CT). 9570 n/d "Store Pagodas" cd. w/ sticker and sked in 111 ds. (Cones-VA). (Palmerheim-MN).

KUWAIT: Radio Kuwait 11675 f/d folder cd. in 46 ds. w/ sticker. (Dillon-PA). same in 1 mo.

LIBYA: Radio Jamahiriya 11816 f/d "Logo" cd. via Malta in 46 ds. for 2 IRCs. (Streeter-NY). same in 33 ds. for 2 IRCs. (Purdum-MI). 11815 same cd. in 19 ds. for 2 IRCs. (Link-GA). f/d "Rainbow" cd. in 33 ds. for 1 IRC. (Wilkins-CO).

LUXEMBOURG: Radio Luxembourg 6090 f/d "Antenna" cd. in 17 mo. for 2 IRCs. (Purdum-MI).

MALAGASY REP: Radio Nederlands 11740 f/d "Flevo" cd. in 18 ds. (Muzyka-NY).

MALTA: Deutsche Welle 15105 f/d cd. in 46 ds. (Forsgren-WI). same in 36 ds. (Falkenhan-MD).

MEXICO: Radio Mexico 15430 f/d cd. in 56 ds. for a SP rpt. (Fortney-PA).

MONGOLIA: Radio Ulan Bator 12070 f/d "Logo" cd. w/ pennant in 118 ds. (Fortney-PA). cd. w/ pennant and stamps in 1 mo. (Johnson-TX).

MONTSERRAT: Deutsche Welle 9545 f/d "Map" cd. in 58 ds. (Stephany-NY). same in 36 ds. (Falkenhan-MD). in 30 ds. w/ sked. (Cones-VA). 11705 f/d cd. in 25 ds. (Fortney-PA).

NAMIBIA: Radio SWA 3295 f/d "Usakus" cd. w/ sticker in 114 ds. for 2 IRCs. (Cones-VA).

NEW CALEDONIA: Radio Noumes 7170 n/d ltr. in 220 ds. for a FR rpt. and 2 IRCs. v/s J. Blasco. (Swaringen-NC).

NEWFOUNDLAND: CKZN 6160 "Map" cd. in 22 ds. w/ sticker for 1 IRC. v/s D. Uttaro. (Cassidy-IN). same in 17 ds. (Falkenhan-MD). in 15 ds. w/ sticker. (Reinstein-FL). (Orekar-CA).

NEW IRELAND: Radio New Ireland 3905 form ltr. in 14 ds. for 2 IRCs.

NICARAGUA: La Voz de Sandino 6220 n/d ltr. in 143 ds. for a SP rpt. * and 1 IRC. v/s Sonia Gongora S. (Konen-WI). La Voz de Nicaragua 5950 p/d ltr. w/ pennant in 111 ds. for an EG rpt. and 2 IRCs. v/s Rodolfo Garcia Gutierrez, Director. (Niekamp-MN). same in 75 ds. for a SP rpt. and 1 IRC. (Scharrer-MI).

NIGERIA: FRCN 4990 Lagos f/d cd. in 9 mo. (Johnson-TX). Radio Jos 5965 f/d form ltr. in 45 ds. for 2 IRCs. v/s F.O.N. Dike, Chief Engineer. (Sizer-CT).

NORWAY: Radio Norway 11870 and 15175 p/d cd. in 18 ds. (Gliksmann-IL).

PAPUA: NBC 4890 f/d "Map" cd. in 64 mo. for 3 IRCs. v/s S.S. Aiau. (Davis-CO).

PARAGUAY: Radio Nacional 11730 ltr. in 1 mo. v/s Carlos Montaner. (Johnson-TX).

PERU: Radio Imagen 5035 f/d prepared cd. w/ personal ltr. in 641 ds. for a SP rpt. and ms. * v/s V. Daniel Coral Perez, Gerente. (Wilkins-CO). Radio Huanta 2000 4755 f/d prepared cd. w/ personal ltr. in 9 mo. for a SP rpt. and ms. (Lazarus-LA). Radio Los Andes 5030 f/d cd. w/ personal ltr. in 2 mo. for a SP rpt. and ms. v/s Pablo Cardenas Valverde, Director Gerente. (Niekamp-MN). same in 125 ds. for a SP rpt. and 1 IRC. v/s Pablo Jacob Cardenas. (Swaringen-NC). Radio Tacna 9485 f/d ltr. in 59 wks. for a SP rpt. and ms. v/s Ing. Alfonso Caceres C., Sub-Gerente. (Lobdell-MA).

PHILIPPINES: VOA Tinang 6110 f/d cd. in 7 ds. (Cones-VA). 15290 f/d cd. in 25 ds. (Plum-NJ).

POLAND: Polskie Radio 11815 f/d cd. in 3 1/2 mo. (Hazeltine-WA).



RADIO NACIONAL DE CHILE
 SANTIAGO DE CHILE - MORANDE 25 - CASILLA 244 - V

FERNANDO CUEVAS MARDONES, Jefe del Area Comercial de RADIO NACIONAL DE CHILE, Certifica que el Señor Gabriel Ivan Barrera, ha recepcionado nuestras Emisoras Radio Nacional de Chile, en la Frecuencia: DE 9550 KiloHertz, el día 19 de Junio de 1983 (entre el horario de las 15.22 a 16.04 Horas G.M.T.)

Todos sus datos son correctos y esta es nuestra Tarjeta QSL.



HCJB WORLD RADIO COMMUNICATION YEAR

HC1JB

HCJB Ham-group, Box 691, Quito, Ecuador, S.A.

RADIO	SWL	DATE	UTC	ORG	2x	RST	24.4 Quad parabolic reflector 1/4λ vertical
T J PALMER		June 83 (1) 12	2300	3, 5, 7 14, 21	SSB CW		

RCN

LA RADIO DE COLOMBIA

POLAND: Polskie Radio 15120 f/d "Lazienki Park" cd. in 55 ds. (Choroszy-ME). same in 105 ds. (Muzyka-NY). 7145 f/d cd. in 110 ds. (Kapinos-MA). 15120, 11815, 6135, 6095, 9525, 7270 and 7145 f/d "Logo" cd. in 35 ds. (Barto-CT). 15120, 9525 and 6095 f/d "Royal Castle" cd. in 127 ds. (Fortney).

PORTUGAL: Radio Japan 11740 via Sines f/d cd. in 48 ds. (Krueger-FL). 11755 "Persimmons" cd. in 27 ds. (Barto-CT). Radio Portugal 9575 f/d "Carpet" cd. in 24 ds. (Dillon-PA).

ROMANIA: Radio Bucharest 9690 f/d cd. in 100 ds. (Muzyka-NY).

RWANDA: Deutsche Welle 17800 f/d cd. in 59 ds. (Stephany-NY). same in 46 ds. (Purdum-MI). 9565 cd. in 1 mo. (Gliksman-IL). 7225 same cd. in 50 ds. (Cones-VA).

SAIPAN: KYOI f/d "Logo" cd. in 43 ds. for ms. (Orekar-CA).

SENEGAL: ORTS 4890 f/d "Logo" cd. in 96 ds. for an EG rpt. and 3 IRCs. (Kapinos-MA).

SINGAPORE: Singapore Broadcasting Corp. 11940 f/d "Skyline" cd. in 127 ds. for 1 IRC. (Cones-VA). BBC 17715 n/d cd. in 19 ds. (Paszkiwicz-WI).

SOUTH AFRICA: Radio RSA 9615 f/d "Ebenezer Dam" cd. in 16 ds. (Forman-NY). 3230 f/d "Johannesburg" cd. w/ sticker in 18 ds. (Forsgren-WI). 9615 and 5980 f/d cd. in 21 ds. (Link-CA). Capital Radio 3930 p/d "Presenters" cd. in 92 ds. for 2 IRCs. (Kapinos-MA). same in 5 wks. for 2 IRCs. (Plum-NJ).

SPAIN: Radio Exterior de Espana 9630 f/d "Marineros" cd. in 35 ds. (Dillon-PA). same w/ pennant in 23 ds. (Gaffin-NY). f/d cd. in 28 ds. (Forman-NY). 11880 cd. in 5 wks. (Hazel-tine-WA). f/d "Art" cd. in 40 ds. (Bruckner-NJ).

SUMATRA: RRI Pekanbaru 5886 p/d ltr. in 11 wks. for an IN rpt. and ms. v/s Zainal Abbas.

SWEDEN: Radio Sweden International 11705 f/d "35 Years of SCDX" cd. in 22 ds. v/s Karin Brindt. (McLemore-FL).

SWITZERLAND: Swiss Radio International 9725 f/d "SRI Logo" cd. in 19 ds. (Fortney-PA). same * in 26 ds. (Dillon-PA). 4UZ United Nations Radio 14500 f/d paper cd. in 13 ds. (Krueger).

TAHITI: Radio Tahiti 15170 f/d "Conch Blower" cd. in 30 ds. for 3 IRCs. (Forsgren-WI). same in 97 ds. (Blanchette-FL). 11825 same in 29 ds. for a FR rpt. and 1 IRC. (Niekamp-MN). in 61 ds. for a FR rpt. and 2 IRCs. (Garavan-PA). 11825 and 15170 f/d cd. in 56 ds. for a FR rpt. and 2 IRCs. (Cones-VA).

TAIWAN: Voice of Free China 11825 f/d "Four Gentlemen" cd. w/ sked. in 52 ds. (Forsgren-WI). WYFR via VOFC 15525 f/d cd. in 40 ds. for ms. v/s Karen Johnson. (Palmerheim-MN).

TANGIER(?): Radio Mediterranee 15250 n/d ltr. in 6 mo. for a FR rpt. v/s * Pierre Casalta, Director General. Sticker rcvd. Ltr. was mailed from 3 Rue Emsallah, Tangier. (name?)

TANZANIA: Radio Tanzania 5050 blue "Africa" cd. in 6 mo. for 1 IRC. (Johnson-TX). same f/d cd. in 342 ds. for 2 IRCs. (Florian-IL). same in 161 ds. for 2 IRCs. (Streeter-NY). in 41 wks. for 3 IRCs. (Howard-CA). cd. in 268 ds. for 2 IRCs. v/s E.A.H. Mkwongwe. (Reinstein-FL). same in 261 ds. for ms. (Buer-FL).

TURKEY: Voice of Turkey 11755 f/d "Kekoua-Antalya" cd. in 20 ds. w/ sticker and pennant. (Link-CA). 11740 f/d "Spoonbill" cd. in 22 ds. w/ sked. (Purdum-MI).

UKRAINIAN SSR: Radio Moscow 15100 via Lvov f/d cd. in 6 wks. (Palmerheim-MN). f/d "Kremlin at Night" cd. in 56 ds. (Fortney-PA). 9760 f/d "Economic Exhibition" cd. in 32 ds. (Cones-VA). 21530 f/d cd. in 56 ds. (Fortney-PA). 9720 via Vinnitsa f/d cd. in 56 ds. (Fortney-PA). f/d "Rowing Canal" cd. in 57 ds. (Purdum-MI). Radio Kiev 17870 f/d "State Museum" cd. in 45 ds. (Dillon-PA). in 43 ds. (Forman-NY). 17900 f/d cd. in 46 ds. (Palmerheim-MN).



Radio Free Grenada
P.O. Box 34, Morne Rouge
St. George's GRENADA



Morne Rouge

Freq. 15105 KHZ

Dear Keith J. Thibodeaux

Your Reception Report of the 9.1.83

has been checked and found correct.

Remarks: Continue to listen. No
Calendar vet. Thanks for writing

Signed: Una Dulica
PROGRAMME DIRECTOR



Grenada

Power

5KW



SÜDWESTFUNK



UNITED ARAB EMIRATES: Dubai Radio and Colour TV 15320 f/d "Map/Logo" cd. w/ pennant in 28 ds. for 1 IRC. v/s Mrs. Kay F. Fenner. (Caravan-PA) 21655 same cd. in 26 ds. w/ pennant for 1 IRC. (McLemore-FL). 15300 f/d cd. in 27 ds. for 1 IRC. Sticker and pennant rcvd. v/s H.F. Fenner. (Bruckner-NJ).

USA: United Nations Radio 15120 via Greenville f/d "Logo" cd. in 10 ds. (Forsgren-WI). 10869 via Bethany f/d "Logo" cd. in 10 ds. for ms. (Purdum-MI). 15105 f/d cd. in 8 ds. (Scharrer-MI). Radio Antonio Guiteras via LVDC f/d prepared cd. in 11 ds. via Chicago addr. (Rigas-IL). KPRC 1616 and 6210 n/d paper cd. in 7 wks. for ms. (Palmerheim-MN). Crystal Ship 7425 f/d cd. in 84 ds. for ms. (Paszkiwicz-WI). Voice of Free China via WYFR 11740 f/d cd. in 33

* ds. w/ sticker, pennant and coral necklace (!) (Palmerheim-MN) La Voz de la Junta Patriótica Cubana/Radio Mambi 7036 f/d prepared cd. in 9 ds. for SASE. v/s Andres S. Alvarez, Director. (Krueger-FL). Voice of Free China via WYFR 5985 f/d cds. in 158 ds. (Forman-NY). Radio Jose A. Echeverria via CID 7465 f/d cd. in 2 wks. for 1 IRC. (Palmerheim-MN).

* Radio Antorcha Martiana 7088 f/d cd. w/ ltr. in 32 ds. for an EG rpt. and SASE. v/s L. Crespo, Secretary General. (Reinstein-FL). Addr: Movimiento Insurreccional Martiano, P.O. Box 440491, Miami, FL. 33144.

VANUATU: Radio Vanuatu 7260 f/d "Tam-Tam" cd. in 67 ds. after a f/up rpt w/ tape and 2 IRCS. v/s Peter Salemallo. (Pate-MD).

VATICAN: Radio Vatican 6185 f/d "50th Anniversary" cd. w/ sked and sticker in 17 ds. for 1 IRC. (Bruckner-NJ).

VENEZUELA: Radio Lara 4800 f/d "Studio" cd. in 36 ds. for a SP rpt. and 1 IRC. (Forsgren-WI). Radio Barquisimeto 4990 f/d cd. in 27 ds. for a SP rpt. and 1 IRC. (Forsgren-WI). YVTO 6100 "Logo" cd. in 110 ds. for an EG rpt. (Kapinos-MA). same in 154 ds. for a SP rpt. and ms. v/s Cn. German Romero Ocampo. (Streeter-NY). Radio Rumbos 4970 f/d "Isla Margarita" cd. in 62 ds. for a SP rpt. and ms. v/s Andres Serrano-Yv5AUU (Streeter-NY). f/d "Caracas Municipal Theatre" cd. in 48 ds. for a SP rpt. (Moore-HOND). Radio Juventud 4900 f/d "Studio" cd. in 35 ds. for a SP rpt. and ms. (Plum-NJ). Ecos del Torbes 4980 n/d "Map" cd. in 1 mo. for a SP rpt. and 1 IRC. (Moore-HOND). same in 26 ds. for a SP

* rpt. and 1 IRC. v/s Desiree Gonzalez. (Forsgren-WI). Radio Nacional/La Voz de Venezuela 9640 f/d "Bullfighter" cd. w/ pennant in 587 ds. for a SP rpt. and ms. v/s Luis Fernandez and Fabricio Ojeda Diaz. (Reinstein-FL). 9529 f/d "Lake Maracaibo" cd. w/ pennant and stickers in 16 mo. for a SP rpt. and ms. (Howard-CA).

WEST IRIAN: RRI Manokwari 6188 f/d ltr. in 7 wks. for an IN rpt. and 1 IRC. v/s Abdul Rachim. Pennant rcvd! (Gliksman-IL). f/d personal ltr. via registered mail in 27 ds. for an IN rpt. and ms. (Palmerheim-MN).

NOTE: That's it for another month. This time we had @ 99 countries reported. A little bit below our average but with quite a few good QSLs...

I sincerely hope that everyone has a verie good holiday season. Best of DX, best wishes for the coming year and may Bhutan and Tristan be heard by everyone... Sam. John Sgrulletta of RR #1, Box 128, Mahopac, NY 10541 needs addresses for hams WR6KY and KV4CD. Any help? Jay Florian advises us that he has just reorganized his shack after getting married. He hope to be very active in DXing this winter season. Don't spend all your time at the dials. Hi! Steve Leite informs us that he is now using the ICOM IC-R70 receiver. Santa Claus came early! A big welcome to C.J. Orekar a new reporter to the QSL Column. Also to Al Sizer who is back after an illness. Peter Dillon is busying studying for mid-term exams in Philadelphia, PA. Hope you pass all of them. Ray Niekamp says that he is starting to enjoy the benefits of QSLing the Latin stations. He is especially pleased with the QSL from Pablo Cardenas Valverde of Radio Los Andes in Peru.

Bill Mayer says that he is presently employed as a DJ at campus radio station WKSC. Its not RSA or SRI but its something.

As I said above the best of this season to everyone.

Sam

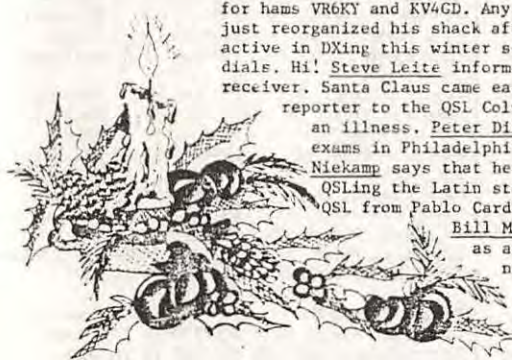

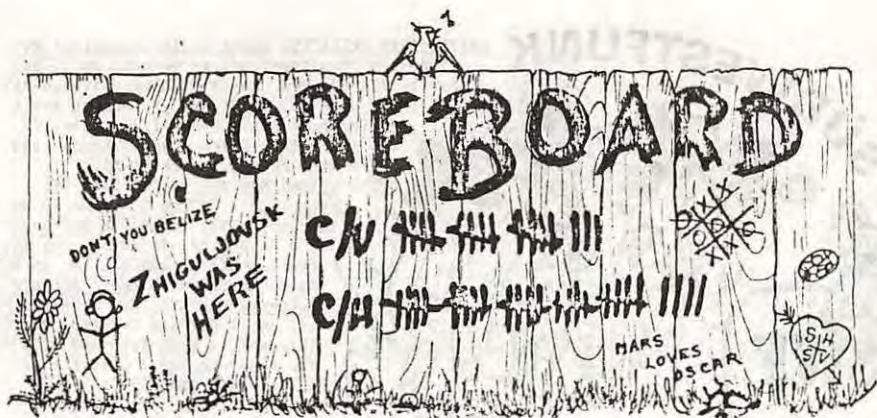

JERRY A. LINEBACK, Editor
115 Wroxton
Conroe, TX 77304

DECEMBER 1983

Greetings to all. We welcome several new contributors this month. This issue of Scoreboard spotlights Oceania and Antarctica. C/H = countries heard and C/V = countries verified. Country counts are by the rules established in the NASWA Radio Countries List and Awards Program booklet. An * after the total C/H = Antarctica heard and an * after the total C/V = Antarctica verified.

The deadline for the next Scoreboard will be 15 February, 1984, for the March issue of FRENEX. NOTE: Publisher Bill Oliver may have to delay the appearance of Scoreboard until the following month due to space limitations in FRENEX. If Scoreboard is delayed, the deadlines do not change. Deadlines are always the 15th of February, May, August, and November, regardless of when Scoreboard appears in FRENEX. This way we can keep everyone's updates on schedule. The next Scoreboard will Spotlight South America.

Thanks to all our contributors. Remember that you must update your totals at least once a year to remain in Scoreboard. If your name has recently disappeared from Scoreboard, it is probably due to your failure to send an update in the past year. Please share your totals with us in the next Scoreboard.

NAME, STATE	C/H	C/V	OCEANIA	BEST	NAME, STATE	C/H	C/V	OCEANIA	BEST
	C/H	C/V	C/H	QSL		C/H	C/V	C/H	QSL
James Young, CA	229*	217*	18	Nabire	John Fisher, Alberta	203*	167*	18	16 Cook Is
John Tuchscherer, WI	227*	19		Fiji	Don Moore, PA/Hond	202*	149	18	14 Wamena
Irving Johnson, CA	225*	62	17	2 Noumea	Larry Abraham, MI	201*	181*	17	17 Cook Is
Gordon Darling, UK	224	215	18	17 Cook Is	Brett Saylor, PA	201*	120	18	10 Manus
Bob Padula, Aust.	223*	217*	19	19 New Hebrides	William Krause, MN	200	153	15	14 Cook Is
Sam Barto, CT	220	211			Al Niblack, IN	200	130		
Al Sizer, CT	218	217	17	17 Cook Is	Paul Buer, FL	199*	183*	17	16 Cook Is
Jerry Berg, MA	218*	216*	17	17 Fiji	W. Max Greenwood, ME	199*	35	17	7 Kiribati
Bryan Clark, NZ	218*	200*	19	18 VQ07	C. J. Orekar, CA	197*	182	18	18 Tarawa
Marlin Field, MI	217*	213*	18	17 Kerema	Mike Ryan, CA	197	164		UNTEA Wirian
Tom Williamson, Ont	216*	199*	15	15 Fiji	Robert Wilkmer, FL	197	126		Kiribati
Bill Sparks, CA	214*	208*	18	18 Tarawa	John Sgrulletta, NY	196*	195	11	11 Cook Is
Tom Gavaras, MN	212*	193*	15	11	Jim Uerlings, OR	196*	54	18	2 RNZ
Nobuaki Takahashi, Japan	212	175	17	16 Fiji	Henry Lazarus, LA	195*	192*	18	18 RRI Serui
Al Miller, OH	211	201	15	14 Fiji	Ron Howard, CA	182*			17 Fiji
Serge P. Neumann, AZ	211*	197*	18	18 Tarawa	Mark Koukol, IL	193*	170*	18	15 Vanuatu
William Flynn, CA	208*	186*	17	17 New Ireland	Steve Reinstein, FL	191*	131*	18	7 New Ireland
Gerald Bishop, PA	208*	181*	18	17 Cook Is	Vladimir Cucura, PA	191*	105		
Victor Jaar, Quebec	208	4	12		Robert J. Vance, FRG	189*	164	15	14 New Ireland
Neal Perdue, AL	207*	55*	15	5 Tahiti	Henry Ward, Quebec	187	163	12	10 Fiji
Terry Krueger, FL	205	123	12	8 SIBC	Martin Foltz, MI	187*	142*	17	14 Cook Is
Sholom Glikzman, IL	203*	173*	18	18 Merauke	C. Vernon Hyson, NC	186*	170*	11	10 Noumea
					Terry Palmersheim, MN	186	149	12	10 Cook Is

NAME, STATE	C/H C/V OCEANIA BEST C/H C/V QSL	NAME, STATE	C/H C/V OCEANIA BEST C/H C/V QSL
Jerry Lineback, TX	186*107*14 8 SIBC	Frank Povsic, FL	128 74
Richard Davis, CO	183*164*16 15 Cook Is	William Plum, NJ	127 86 6 4 SIBC
John Bryant, OK	181 133 18 18 Manus	Arnold Lausevich, WI	126* 93*10 9 IRA36
John Huniwell, NJ	180*177*16 14 IRA36	Robert L. Woods, VA	126 43 5 2 Guam
Jerry Johnston, KY	180* 99*15 8 N Hebrides	Sheryl Paszkiewicz, WI	122*90* 9 7 KTRW
Brian Alexander, PA	179* 76 16 5 VNG	Gene Purdum, MI	122* 76*10 5 RNZ
Hadley Cress, VA	179 8 9	Leon Kanopka, NY	120 99
Stephen Leite, MA	178*150*11 10 Cook Is	Peter Tutak, NJ	120* 88* 6 4 Noumea
Del Fye, FL	178*136*13 10 Cook Is	David Benner, IN	117 83 8 5 SIBC
Andy Leskowitz, MA	177*101 12 6 Cook Is	John Dillaman, OH	114 90 10 8 Cook Is
Mike Hardester, CA	176*161 16 16 Fiji	Boris Benkovich, BC	114* 73*11 8 Vanuatu
Robert Fleck, TX	176*144*15 11 Cook Is	Bill Taylor, PA	113* 91* 8 7 Cook Is
Mark Konen, WI	175 137	Dale Park, HI	111 29 14 3 RNZ
Nelson George, NC	172*137*13 12 Kiribati	Greg Hart, FL	110 60 7 5 SIBC
Hans Johnson, TX	171 123 13 12 Cook Is	Daniel Sampson, WI	106* 65 7 4 N Britain
John Meyer, WI	170 125 16 12 Sorong	J. Gary Pate, MD	105* 71 9 6
Walter Kunz, PA	169 89 12 10	Tom Mooningham, NC	97 84
Morley Kirkland, Ont	165 149 11 10 Cook Is	Louis Sica, Jr., NJ	96 35 5 3 WVVH
Ewald Bartunek, Austria	162 135 5 4	Robert Fraser, MA	91 65 5 4 Tahiti
		Peter Giacomelli, NY	89 72 5 4 Tahiti
Shawn McDaniel, IN	162 56 4	Bob Gunderson, MN	89 57
Paul Choroszy, ME	158*121*11 11 IRA36	Homer Ingler, FL	87 63
David Maxfield, MI	158* 16	Ron Tekulve, Jr. OH	82 67 3 3 Guam
Tim Hall, CA	157*115 16 10 Kiribati	Frank Wheeler, KS	80 65 5 5 P/NG
Bob Streeter, NY	157 115 12 11 Cook Is	George Tokarchick, NY	80 60 3 1 RNZ
Dan Miller, WI	157* 23 15 4 RNZ	Mike Martin, IN	79 56
Baxter Hensley, TX	156 140 14 13 Cook Is	Gerald Clark, IN	78 62 4 4 Guam
Mark A. Duba, VT	155 117	Robert Luke, OH	78 48 4 4 RNZ
Larry Cunningham, OH	155* 55 13 6 Vanuatu	Michael Monaco, NY	77 53 4 2 Brisbane
Steven Lare, MI	154*111*12 11	Jean-Pierre Caravan, PA	76 50 4 4 Tahiti
Daniel Viens, NH	153 7 10 2 RNZ	Ray Forsgren, WI	74 40 5 4 Tahiti
Norman Bobb, MN	153* 1 13	Joe Talbot, Alberta	73 48 10 8 Cook Is
Jim Green, AL	152 112	Richard Cassidy, IN	72 57 8 7 Noumea
Ken Cobb, ME	152*104*12 8 Cook Is	Edward Overstreet, GA	71 62
Don Hosmer, MI	148*116*14 11 Vanuatu	Todd Smith, CT	71 52
David Swaringen, NC	147*109 12 11 Kiribati	Rob Sobkoviak, IL	70 50
Fred Kohlbrenner, PA	146 113	Ronald Purdue, MN	70 42 10 2 Australia
Pasquale DiBiase, ME	146* 95*11 6 SIBC	Eric Mayer, OH	70 41
Brian Sarkisian, MI	144 92	Joe Polchlopek, Japan	69 40 11 7 SIBC
Ken Loh, AZ	14 *103*11 8	Tom Mazelrine, WA	66 55 9 7 Cook Is
Scott Warner, SC	141*104*12 6 SIBC	Jack Kibecker, Mexico	64 39 3
Austin Kelly, IL	138*112*13 10 Cook Is	Brett Whysler, CT	61 32 2 1
James Clifford, FRG	138 110 10 10 N Britain	Glen Piper, MI	50 25
Christos Rigas, IL	136 107 6 6 Tahiti	Norman Drew, BC	41 31 5 2
George Link, CA	135 106	Josh Gaffin, NY	36 24 2 2 Australia
Gayle Van Horn, TX	135 95 13 8 Cook Is		
Nolan Stephany, NY	133*113*11 10 Cook Is		
Gene Eastman, TX	132 80 7 6 SIBC		
Gilles Michaud, Que	131* 58 6 3 RNZ		
Timothy Noonan, WI	129 99 6 4 Pt Moresby		

Thanks again to all our contributors. We look forward to hearing from you again. We invite those who have not previously contributed to send their totals for the next Scoreboard. Remember: Deadline will be 15 February 1984. The Spotlight will be on South America.

73 Jaf

update

December 1983***Number152

Tom Allaman
636 E. 74th Terr.
Kansas City, MO 64131 USA
(816) 523-7292 7-10 pm Central only

UPCOMING DEADLINES: 10 December (Mid-Dec) 20 December (January) 10 January (Mid-Jan)

Reproduction permitted. Credit original reporter and NASWA UPDATE. Dates, times and days GMT: freqs kHz.

- ALASKA** KNLS, 6170, in after 1200; fater many tries, finally noted w/ prgm of classical mx. Freq clear before 1200. (Field, MI 11-16)
- CHILE** No local ID on this which did ID as part of R. Nacional net, 9550, in SP 0040-0300; this is R. Portales old freq. "Futbol in Chile" prgm. (Field, MI 11-13)
- CHINA** CPBS-1, 5915, at 2143 w/ W in CH. Dual 5860 and was inferior and had echo. Undoubtedly two different and widely separated xmtr sites. (11-3) CPBS-1 also noted on 4460 at 2127 w/ wake-up exercises; much weaker than // 4905. (11-9) Heilongjiang PBS fair around 2145 w/ modern-style Chinese songs, brief anncmts in Korean by W; this on 4925 during an extraordinary low band opening to the Far East on 11-9. FFBS-1, 3000, weak at 2157 w/ CH mx and talk past 2200; pips on hour, if any, were inaudible. (11-9) Also could hear faint audio from the PRC stns on 2310, 2340 and 2490 around this time. Amazing! (An understatement that. tba) On 6015, an unlisted BBS stn was observed w/ usual pips (5+1) at 1200, then CPBS ID in CH. Not dual 6075. At first I thought this was the Korean that operates here and is very strong in WCNA. (All from Bob Hill, MA)
- CLANDESTINE** V. of Free Nicaragua (tent on ID), 6210, in EG 1200-09; fair poor. M talking about crimes and exterminations committed by the Managua government, martial mx and then off. (Hewitt, MI 11-12)++R. Free Surinam, 6851, in lang 0056-0128:55*. Technician corrected freq to 6850 at 0119. Fascinating prgm but it's all Greek (Sranantongo?) to me, hi! I particularly enjoy their theme song, sort of a disco-military-Hindu sort of ditty. (Ralphus, TX 10-22)++R. Nejat Iran (Liberation Radio/Radio Salvation of Iran), 11659.2, in lang 1902-25*; heard well 11-6. A variety of exotic Persian mx selections, M&W anncrs, a number of IDs with "Nejat" clearly heard in Farsi talks. At one point gave address letter by letter, but tough in reception and couldn't copy. (Ralphus, TX)
- COSTA RICA** R. Rumbo, 6075, in SP 1150; poor. latin mx and ID at 1150 by M anncr. (Hewitt, MI 11-12)
- ECUADOR** R. Panamericana de Quero, 3289.7, in SP 1028-1042; poor and rough tuning 10-18. Sig a bit too unstable for ECSS. Bad QRM from ever-present OC on channel. M gabbling in SP at t/in, clear mentions of Quero and TC as "las 5 de la manana y 29 minutos en R. Panamericana." Into HC folklore show w/ organ mx. Was hoping for the Peruvian actually but nice to hear this one again after a couple of years. (Ralphus, TX)++R. Zaracuy, 3395, in SP 0235+ 11-17; mx prgm w/ ID 0242 and 0250 as "R. Zaracuy, la voz de Santo Domingo de los Colorado en Republica de Ecuador." (Field, MI)++Presumed Em. Gran Colombia, 4910, in SP *1145 10-30 weak but unmistakable HC anthem noted, in big het. Couldn't pull ID but fairly sure this is it. (Ralphus, TX)
- GRENADE** Nx report in USA Today stated stn R. Free Grenada now renamed Spice Island Radio and b¹ asking request to remaining Cubans to turn selves in and for island commerce to get back to "business as usual." (Ralphus, TX)
- GUATEMALA** R. Tesulutlan, 3370.5, in SP 1015-25; very deceptive since rather weak and not // 4835. Guitar selections and clear ID as Emisoras Tesulutlan at 1025, whence I promptly tuned out. Hankering for R. Florida, actually. (Ralphus, TX)
- INDIA** AIR Hyderabad, 4800, in lang 1158-1215; buried in QRN. OC 1158, *1200, anncmts, station ID, Indian instr mx. (Barto, CT 10-22)
- INDONESIA** Bulungan, 2977, in IN 1245 11-6 1245, but none of the Indo cohorts noted this date. Followed to SCI 1300 when long dead air as they waited for Jakarta. (Ralphus, TX) ++RKFDTI Jawa Timur, 3000, noted w/ nice sig 10-20 1227; the Indo season is at hand! Also noted an Indo unID on 2987 1225-51; hoping it's Ngawi. Went there once, and now hope to add it to the "visited and QSLed" category. (Ralphus, TX)++RRI Ambon, 4845, in IN 1130-45; station ID and talks, instr mx, vocals and mention of Ambon. (Barto, CT)++RRI Palembang, 4856, tentative 1130-42 10-22; seeming short nx prgm followed by pause, station ID and vocal tune by M. RRI ID heard but not site. (Barto, CT)++RRI Surakarta, 4899, in IN 1120-33 w/ anncmts by W, station ID and instr mx. Weak to fair. (Barto, CT)
- JAPAN** R. Tanpa/NSB showed well two consecutive afternoons on 3925; first noted from 2104 on 11-8 w/ JP dialogue between M and W; peaked at fair level around 2120 and faded out completely by 2130 or so. Next day hrd same time w/ even better signal. (Hill, MA)
- KOREA (DPR)** Pyongyang, 2850, sometimes at strong level around 2150 on both 11-8 and 9 w/ usual Korean exhortations and revolutionary mx. On latter date also fair were 3032 dual 2850, 3015 in JP and 4557 (VoRev. Party for Reunification) all around 2130 to 2200. No trace of any of them since 11-9 however. (Hill, MA)
- MEXICO** XEWX, 6165, in SP 1130 various mornings w/ local ads. (Field, MI)++R. Universidad Nacional de Mexico, 9600.7-9601.2 reactivated (finally!!!). After several years of checking only to find RMWS, EUNM popped up 10-30 1303-21* on local Sunday. Gone abruptly in mid-

stream due to technical problem. Retuned 1731 and noted them again through 1825 t/out, sometimes w/ good power. Bad het at times but RM not noted until check at 0200 when RMWS blotting out channel. During 1731+ period, medieval flavor Latin choir selections, fabulous and moving mx. Several times, sequence of 4 chimes, ID and 4 more chimes. At 1804, choral prgm ended w/ W back-ID of prgm, then M mentioning: "Senoras y Senores, la programacion correspondiente al dia de hoy de Radio Universidad Nacional de Mexico... orgullosamente ahora presentamos a las doce con 4 minutos La Orquesta Filarmonica de la Universidad Nacional--muy buenos tardes." Then live anncr from concert haal did play-by play of maestro's arrival. Gave ID at same time as "transmisor de onda corta...R. Universidad Nacional de Mexico en 9600 kHz banda internacional de 31 metros de onda corta...y...de frecuencia modulada estereofonica." Then into symphony w/ fine sigs to 1825 t/out. At 1851 recheck M interviewing W about unique instrumental variations of University symphony. (Ralphus, TX)

NIGERIA VoN, 7225, in EG 11-12 0500-0600; included nx and into FR at 0600. ID as West African Service of VoN. (Field, MI)

PERU R. El Sol en Los Andes, 3230s, marvelously strong 10-30 at 1005+. Cumbias (yes!) and 2 anncmts mentioning LV de Qollosuyo. Thought I had something dandy cooking but then at 1008 came mellow queenas tema and then OM anncmts in eco, followed by different anncr saying, "A traves de R. El Sol en los Andes, muy buenos dias." Into huaynos. Always happy to hear this one. (Ralphus, TX)+++R. Bagua as follows: 3309.9 hrd *0957 w/ NA, then fast s/on by M: La hora en Bagua, 5 de la manana." Then jazzy mx, M&W canned s/on anncmts. Vy strong now that s/on is an hour earlier. Also noted 10-30 on 3310.4 rather early at 1013 w/ best signal yet. Many IDs by W&M, she w/ theme), 1014 full ID w/ MW, SW freqs and calls, 5:15 t/c. Obviously former *1045 s/on no longer applies w/ expansion of b'cast day. (Ralphus, TX)+++R. Concordia, 9580.3, in SP 1005 10-22; located in Arequipa. Folklore prgm w/ W anncr, and reasonably good at 1030 recheck. Have only hrd this on weekends so far. No QRM this time. unlike prior log. (Ralphus, TX)+++R. Norperuana, Chachapoyas, 9655, in SP *1055 10-22; anthen then W w/ quick ad libbed opening anncmt, not canned version. Into queenas and drums tune. Good sig. (Ralphus, TX)+++Estacion 2000-Radio, Rioja, 9988: lowdown per lengthy QSL from v/s Sr. Pedro Rojas Melendez, gerente. QTH as reported by Codina, Jiron Faustino Maldonado #731, Rioja. Slogan is "La Radio con Personalidad," and is small enterprise w/ 7 employees. Stn uses Royce brand xmtr of 12 (yes, 12) watts output, "with a view to raise this to 50 watts in the future." Antenna is "coaxial w/ two towers 17 meters high." Transmissions thus far in test mode. Station has recently added a Royce brand mobile unit to its growing equipment base w/ a range of 15 km. Sr. Rojas is intrigued about the possibility of importing a 500 or 1kw commercial grade xmtr. Current Mon-Sat sked projection for local audienees is: 1130-1200 APERTURA DE PROGRAMACION, con musica del Folklore Internacional; 1200-1300 PANORAMA ESTUDIANTIL, temas de cultura general y mxs OA folklorico; 1300-1700 LA MANNA ESPECIAL, programa cultural, consejos familiares, horoscopos del dia, musica varida; 1700-1800; PERU CRIOLLO, valse peruana; 1800-1900, LOS INSTRUMENTALES DE LA HORA, musica clasica; 1900-2200, LOS CONSA GRADOS DE LA TARDE, musica variada; 2200-2300 LA JUVENTUD Y SU DISCOS, musica pop; 2300-2400, RECUERDOS JUVENILES, musica del recuerdos; 2400-0100; MUNDO DEPORTIVO, noticias deportivo nacional y internacional; 0100-0200, LOS SUPER EXCITOS, las ultimas en baladas; 0200-0300, TU YO Y EL AMOR, baladas y poemas romanticas. 0330-0400, DESPIDDIDA DE PROGRAMACION, musica peruana. Sunday prgms are completely different and prgm days is 1100-0200. (Ralphus, TX)

SCOTLAND (I hope) R. Freedom Int., 15040, caught on 11-6 at 1148 w/ several IDs. Also gave mailing address and freq. Also gave mailing address and freq then apparently went off air 1152, although a BFO note could still be heard. Tnx to the ever-vigilant Jerry Berg for calling me w/ this one. (Hill, MA)

SOUTH AFRICA R. South Africa, 3995, in EG 2255; 11-6. Lots of ARO QRM; talks. (Field, MI)

SUDAN On 5039, Omdurman found at very weak volume from 2104 w/ AR nx. good quality audio. Into slow-tempo Somali-type mx at 2111. So Sudan lives, but is in intensive care unit. (Hill, MA 11-9)

TURKEY Turkish State Meteorological Service, 6900, fair but with unusually bad band noise *0359 w/ NA (which I remember well from the year I spent there); 0400 anncmts by W whose voice was so high-pitched as to be beyond understanding; 0404 into Turkish vocal w/ instrumental back-up. Gone 0440 recheck. (Hill, MA 11-7)

USA VOA Dixon, 6040, strong as would be expected 1255-1325 t/out in SP. (Ralphus, TX)

USSR Vladivostok, 4040, in at 2127, easy listening mx, Mayak IS 2129 then W in RS 2130. Fair then, strong by 2150 on 11-8. Tbilisi, 5040, in weakly 2100 w/ Kremlin bells, clock striking 12 and USSR anthem to 2102*. het QRM from Sudan (!) on low side. TBS shows Tbilisi to 2400*. (Hill, MA 11-8)

About out of room for this edition. My very best to you and yours for a joyful and prosperous holiday season and new year. Hope Santa brings you that QSL or receiver you've been wanting.

Hope everybody had a wonderful Thanksgiving. Hey, is anyone out there looking for a Hammarlund HQ-180? Mine is on the block. I'm selling it with a KRS Digital Frequency Display for the bargain price of \$450 or best offer. If you're interested, call me at (312) 761-0470. It makes the perfect stocking stuffer...and I want an NRD-515! Just to be different, we begin this month with a (gasp!) mediumwave log.

- *****
1555 CAYMAN ISLANDS, R. Cayman; 2324-0015, EG, road closings, wx, ads for Rumpoint Club, Marlboro, Toyota (Alcorn, 10/20)**Not shortwave, but interesting nonetheless. Let's see if the purists crucify me.
- 1610 ANGUILLA, Caribbean Beacon; 2300, EG religious px (Alcorn 10/24)
- 1616 USA/Pirate, KPRC; 0557, EG, Pirate Joe and Pirate Ed, oldies, taking phone calls at 212/352-9906, better than //6280 (Fields 10/10)
- 2390 MEXICO, R. Huayacocolta; news from 0045, complete ID, "2390, R. Huayacocolta...potencia," NA, 0109* (Field, 11/2); 0047, SP, nx w/Star Wars interlude, 0107* (McDaniel 11/5)
- 2410 BRAZIL, R. Tranzamazonica; 2335-0020, Brazilian and US pops w/IDs by OM every other song and canned IDs, even a song by the Police! (McDaniel)
- 2800H HONDURAS, El Eco de Honduras/San Pedro Sula; 0104, 2x1400, great sig w/relay of sister station R. Variedades (Krueger 10/19)
- 2850 NORTH KOREA, R. Pyongyang; 2200, nx, tx over Taiwan (Schulze 10/13)
- 2977P INDONESIA, PRDT2/Bulungan; 1345, pop mx, YL singer, listed in TBS (Moman 9/23)
- 3205 BRAZIL, R. Riberao Preto; 0035, PT very weak (Weinbold 10/25)
- 3205 PAPUA NEW GUINEA, R. West Sepik; 1134, PD w/sining mx and comments (Bolland 10/9)
- 3215 INDONESIA, RRI/Manado; 1122, IN, comments along w/mx (Bolland 10/1); 1358, ID by YL into pop (Moman 9/23)
- 3220 UNID, SP, YL tx, TC in EG, "The time is now...", strange but I had to clear "R. Nacional de Espana IDs after 0400, first by YL w/fanfare, second by OM in tx. I'm confused! (Moman 9/26)
- 3230 PERU, R. El Sol de Los Andes; 1002, SP, OM/YL w/comments which sound like ADS w/many mentions of Iquitos (Bolland 10/7)
- 3230 SOUTH AFRICA, RSA; 0300, mocking bird IS just prior to s/on, EG serv. of RSA, //9585, 7270, 5980 and 4990 (Desrosiers 10/29)
- 3250 SOUTH AFRICA, R. Five; 0053, rock mx (Rigas 10/30); U.S. pop and adult contemp. mx 0320-0350 (Jordan, Dillman)
- 3255 LIBERIA, ELWA; EG, lite classical mx, s/off anmts at 2358 w/ID (Moman 10/11)
- 3255 VENEZUELA, LV de El Tigre/R. 980; SP, lots of fun trying to catch ID on this even tho they ID's after every song, trouble was every one sounded different! Some like "R. Melodia..." blanks sometimes like Sutatenza, some mentions of "El Tigre", 0157 (Moman 9/25); 0348-0424* (Burke 10/19, Jordan 10/30); *0957, SP, caught NA, s/on into morning report (Gliksman 10/29)
- 3265 RRI/Gorontalo; 1359, another ID, possible nx (Moman 9/23); UNID, 1114, IN w/tx by OM, pop mx, ballads, a few vocals in IN (Barto 10/9)
- 3275 VENEZUELA, R. Mara; 0315, SP, LA mx, vocals, ID at 0320 (Stanley 10/1); 0315, LA pops, OM (Plotnick 10/30); AA px previously reported by Krueger to 0012, then SP (Gliksman 10/3); positive ID by OM 0219 (Desrosiers 10/8)
- 3285 BELIZE, RB; 0300, EG, ID among het from ute, poss. BBC nx, TC-2 hrs EDT (Burke 10/26); 0311, EG/SP (McLemore 10/18); 1220-1230, EG, OM w/greetings, TC, Neil Diamond mx (Trotto 10/21); 0015, SP, nice inst mx (Prath 10/24); EG "Caribbean Mag" (Alcorn 10/26)
- 3295 NAMIBIA, SWABC; 0435-0452*, AK, EZL mx, into '40s style mx

- (Jordan 10/30); 0230, mx px (Field 10/26); tent. 0248(Plotnick)
- 3310 PERU, R. Bagua; 1013, SP, mx, TC and cmty, ID by YL during mx, OM ID after, this format has been noted on other Peruvian stations such as R. Los Andes on 5030 and R. Imagen on 5035 kHz (Bolland 10/15); *0958, finally got a couple of IDs, pretty good sig, but big OC on top means you have to tune the low side (Berg 11/1+); 1030, s/on w/ID and Peruvian mx, faded by 1050, anyone have an address? (Field 10/18)
- 3315 ECUADOR, R. Pastaza; 0230, mx w/ID 0235 (Field 10/29)
- 3325 GUATEMALA, R. Maya; 1132, ID by OM followed by "Church Chimes" played by a chorus (Jones 10/18)
- 3339.7 ZANZIBAR, RTZ; 0314-0326, believed the one here w/OM chanting til 0316, then tx by OM, some afro mx at 0321, faded badly by then, wish I could have been on freq 0300 (Valko 10/4); 0304, tuned in to hear continuous Koran chants, f/out 0319 (McDaniel 11/8)**Thanks for the call, Shawn. Appreciated the tip. mln.
- 3366 GHANA, R. Ghana; exc. signal 0540 w/male DJ, Afro mx, interview w/EG record producer (DiBiase 11/2)
- 3370 GUATEMALA, R. Tezulutlan; 0212, SP, nice marimbas, tx by OM w/ID at 0212 and 0225 (Valko 10/27)
- 3381 ECUADOR, R. Iris; 0023, nx and cmty w/IDs to 0035, Latin ballads at 0340 to s/off (Gliksman 10/2)**Glad to hear you're back in commission, Sholom. Hope you're feeling better. 0235, LA mx w/YL vocals (Plotnick 10/30); 0230, OM w/what sounded like nx, ID several times, into mx (Desrosiers 10/8)
- 3385 INDONESIA, RRI/Kupang; 0932, IN, YL w/nx, after nx at 0940, mx, by 0948, signal lost its strength (Bolland 10/15)
- 3385 PAPUA NEW GUINEA, R.E.N.B.; 0932, OM, PD mx and comments, XMAS songs played, faded by 0951 (Bolland 10/15)**Interesting. Here in Chicago, PNGs are in well past 1230. They don't fade in until approximately 1130, although that changes with the darkness pattern. Surprised there is this much of a difference between the Midwest and Florida, mln.
- 3394 ECUADOR, R. Zaracay; 0235, SP, combo of LA mx and rock, lots of CW QRM (Plotnick 10/30)
- 3669 CLANDESTINE, V. of the Broad Masses of Eritrea; 1815, Oromo, anti-Dergue tx, chased by jammer. Freq varied to 3707.5 (Wood, Saudi Arabia 10/15)
- 3830 VENEZUELA, R. Tachira; SP, 1007, much LA lively vocal mx, OM w/ID and ment. of Venez. Also hrd on 5830 (Valko 10/2 --at Vladimir Cucura DX session)
- 3905 INDONESIA, RRI/Banda Aceh; 1703*, IN s/off w/soft island mx, WRTH says 1600* (Wood 10/1)
- 3915 SINGAPORE, BBC; 1200, "EG by Radio" (Moore, Honduras 10/5)
- 3935 INDONESIA/JAVA, RRI/Semerang; 1150, IN, YL vocal mx, ID by YL, tuning sig (Moore 10/11)
- 3958 FALKLAND ISLANDS, FIBS; tent nx nx in EG by OM, tx about Grenada, time 0325, tent. ID (Plotnick 10/30)**Hmmm...mln.
- 3965 FRANCE, RFI; 0530, FR, nx by YL, ID, ARO QRM (Trotto 10/16)
- 3985 WEST GERMANY, R. Liberty; 0340-0400*, RS, nx in RS, then OM, mentions of Grenada, Argentina and USSR (Jordan 11/3)
- 3995 WEST GERMANY, DW; 0500, GG, ID, nx by OM, YL ID (Trotto 10/16); 0105, nx by OM in GG, //6075 (Prath 10/21)
- 4000 CAMEROON, R. Bafoussam; 1738, EG listener's request px (Schenke 10/16); 0435, OM, Afro vocals, nx in EG/FR (Cobb 10/18); 0535, FR, pops, native mx (Witte 10/28)
- 4330 CHINA, People's Liberation Army (PLA); 1240, CH mx (Purdue, 10/9); 1310, CH tx (Lineback 10/23); 1231 (Nikoilch 11/7)
- 4485 USSR, Petropavlovsk-Kamchatsky; 1400, RR ballads (Lineback 10/22)
- 4557 N. KOREA, V. Revolutionary Party; KK, tx (Lineback 10/23)
- 4607.4 INDONESIA, RRI/Serui; 1253-1301*, tent w/mix of trad. and pops, anmts from 158, too weak to make out ID (Gliksman, Lineback)
- 4610 USSR, Khabarovsk; 1400, tx in RR (Lineback 10/22)
- 4620 CHINA, Beijing; 1255, CH, vocals (Lineback 10/23)
- 4656 ECUADOR, C.R.E.; SP, romantic songs w/vocals, 0335, TC @ 0407, freqs and s/off (Stanley 10/23); SP, OM, no ID (Konen 10/15); 0305, sx event, full IDs (Desrosiers 11/5)
- 4699 INDONESIA, RKIP/Surabaya; 1250, IN, OM, tent. (Lineback 10/23)
- 4719.5 INDONESIA, RRI/Ujung Pandang; 1400, IN, tx, vocals, UTE QRM per usual (Lineback 10/22); 1204, "Song of the Coconut Islands" played once, ID as "RRI/Ujung Pandang," into presumed nx (Valko

- 10/4); 1235, OM/YL w/nx (Bobb 10/12)
- 4740 AFGHANISTAN/USSR, R. Afghanistan; lang, 0200, just caught last half minute of some soft of wailing by male, mention by OM of Kabul (Valko 10/27)**In here most mornings...mln.
- 4746.5 PERU, R. Haunta; 0907, SP, mx and cmty, sign vy weak today compared to first time hrd (Bolland 10/20)**Formerly on 4755. UNID, 0022, SP w/Andean-style mx, some romantic suff, DJ is rarely above noise, usual Peruvians noted when this one is in. Mention of Huanunin or Junin or Huancin...any help (Sheedy 10/19 and other October dates)**Sounds like R. Haunta, OM. mln.
- 4755.7 BOLIVIA, R. Emisoras; 0932, SP, OM/YL, mx (Bolland 10/14)
- 4762.8 PERU, R. Inca; 0926, SP, station promos and ads w/"hard sell" approach. (I never knew radio ads were intended to be soft-sell. mln.) 0928, mx (Bolland 10/14); 0927, some mx but mostly tx, full taped ID and mention of AM and SW w/call letters (Valko 10/31)
- 4765t BRAZIL, R. Rural Santarem; 0849, PT, accordion mx and lots of tx by OM, tent. ID (Gliksman 10/29)
- 4765 BRAZIL, R. Nac. de Cruzeiro; PT, OM, 1008, mx and cmty, R. Moscow killed signal at 1012 (Bolland 10/13)
- 4765 LIBERIA, ELWA; 2214, EG, relig. inspiration mx including YL version of "Amazing Grace" (D'Angelo 10/13); 0610(Summers 11/1)
- 4770 NIGERIA, FRCN/Kaduna; 0015, EZL mx, EG, ID (Moman 10/12); 0440, EG, pop mx, OM (Summers 11/1); 0053-0101*, C&W mx, NA 0100 (Bolland 10/18); 0400, EG, drums, IS/ID, prayer (Stanley 10/17); 0430, EG, U.S. pop, disco (Desrosiers 10/30)
- 4770 VENEZUELA, R. Bolivar; 1020, SP, lively LAM ballads (Trotto 10/21); 0210 (Plotnick 10/30); 0340, OM DJ w/patter btwn selections, def ID w/mx notes before it (Jordan, Ware) +1
- 4774t INDONESIA, RRI/Djakarta; 1118, IN w/OM, clear and steady, RRI ID at 1130, also noted 4899/4875/4719, is Djarkarta still on this freq? (Barto 10/15)**RRI station noted on this freq here in Chicago area past 30 days. mln.
- 4775 BRAZIL, R. Cultura de Sergipe; 0914, PT, cont. ballads, ID at 0920 for "R. Cultura" (Gliksman 10/29)
- 4780 DJIBOUTI, RTVD; 0305, continually heard throughout October, tough copy due to QRM (Bolland, Field); 0300 (Wilkner 10/9)
- 4780 VENEZUELA, LV de Carabobo; 0346, LA mx, IDs, TC(D'Angelo 10/15) 1030, SP, ID (Niekamp 10/15); 1015 (Trotto 10/21)+2
- 4785 BRAZIL, R. Ribamar; 0833, PT, sig fading in and out, mx px, tent. logging (Bolland 10/8); 2330, PT w/OM ID (incl. reverb), street band-type mx (Desrosiers 9/24)
- 4785.1 COLOMBIA, Ecos de Combimas; OM w/fast IDs, upbeat marimba type mx, 0100 (Desrosiers 10/2)
- 4789.2 INDONESIA, RRI/Fak Fak; tx in IN, 1240 (Lineback 10/23)
- 4790 PERU, R. Atlantida; 0911, SP, full ID "...Transmite R. Atlantida, Iquitos, Peru..." (Bolland 10/20)
- 4792 ECUADOR, Emis. Atalaya; 0501, SP, good w/ID followed by lcl mx (Rigas 10/8); 0416, SP, futbol, TC (Paszkievicz 11/2); 0411, upbeat Latin pops, frequent IDs by OM (Cunningham 10/8)
- 4795 CAMEROON, R. Douala; 2108, EG, national svc nx relay, ID as "R.N...Douala" (Choroszy 10/9); 2303*, FR, many IDs (Valko 10/4); 2113, EG nx (Burke 10/20); *0504 (Ravenhorst 10/6)
- 4800 INDIA, AIR/Hyderabad; 1158, open carrier, s/on 1200 w/station ID, Indian inst. mx (Barton 10/22)
- 4800 UNID, relig. bcst, 0305, beneath R. Lara (Field 10/2)
- 4800 ECUADOR, R. Popular Independiente; SP, slow inst mx, OM at 0400 w/nx (Konen 10/9)
- 4800 VENEZUELA, R. Lara; 0205, SP, LA mx, full ID by OM (Plotnick)+1
- 4810 GABON, Africa #1; 2135-2300*, speech by Pres. of Gabon, nx and cmty included report on S. Africa raid on Mozambique (Enkenhus 10/17); FR, 2300 (Purdue 10/9); 2250, pop mx (Ware 10/24); 2135 (Plotnick 11/7); 2240 (Lineback, Desrosiers)
- 4810 PERU, R. San Martin; 1041 SP, Andean mx, TC, ads for Inca Cola (Moore,Honduras 10/6); tent 1001, under heavy QRM, cmty by OM, poss. nx (Bolland 10/18); 1000 (Field 10/23)
- 4815 BRAZIL, R. Nal. de Tabatinga; 0240, mx (Field 10/22); 1026, PT, tx px w/a vocal at 1029, ID, bird calls (Gliksman 10/29); 0848, long tx by OM (Valko 10/2); *0959 (Bolland 10/11)
- 4815 UPPER VOLTA, *0559, FR, s/on w/IS, "Ici Ouagadougou," NA, then

- singing (Valko 10/2); 0559, s/on (Alexander 10/15)
- 4820 ECUADOR, R. Paz y Bien; 1002, SP, relig. tx, Andean mx, TC and ID, cmty abt El Salvador (Choroszy 10/20)
- 4820 HONDURAS, HRVC; SP, Christian mx, OM ID at 0321 (Stanley 10/25) 0358, EG weekly px "Bringing Christ to the Nations" (Burke 10/16)
- 4825 BRAZIL, R. Educadora; 0846, PT, OM/YL, mx and tx (Bolland 10/8)
- 4825 COSTA RICA, R. Colombia; 0340, SP, clear ID, ads and anmts (Stanley 10/24); 1047, IDs, TC (Moore 10/16); many IDs 0320-0420 (Jordan 10/23); 0328 and other times (Lineback, Moman, Ware, Field, Konen, Nikolich, Valko, Rigas, Krueger, Cunningham, Alexander)
- 4825 USSR, R. Moscow; 2150, SP, IDs at 2157 and 2158, nx (DiBiase 11/1)
- 4830 VENEZUELA, R. Tachira; 0115, "LV del CID" px, then sx at 0132 (Field 11/3); 0950, peppy Venez. mx, TCs/IDs (Neikamp 10/15); 0040, QRM de Reloj 4832 (Prath 10/22); 0205 (Plotnick 10/17)+1
- 4835 S. AFRICA, SABC; 2200-2204*, EG, classical mx, ID, invited listeners to tune "all nite svc of R. Orion" (Alexander 10/18)
- 4840 VENEZUELA, R. Valera; 2305, SP, LA mx, ID and TC (Prath 10/28)
- 4845 COLOMBIA, R. Bucaramanga; 0939, SP, TC and ID, mx, they seem to have moved up 700Hz from previously (Bolland 10/20); 0510, SP, frequent IDs, full ID (Lausaevich 10/9); 0517, on 4846, many IDs and anmts by OM (Johnson 11/5); 0618 (Sharpe 10/14)+5
- 4845 MAURITANIA, RM; 2257, AR, mx, nx at 2300 (Bolland 10/18); 2332, AR, chants, 0003* (Plotnick 10/29); 2238, short mx selection and back to tx, ID at 2300 into nx (Desrosiers 11/6)
- 4845 INDONESIA, RRI/Ambon; 1202, YL w/nx and ID (Bolland 10/9); 1130, ID, tx, inst., mention of Ambon (Barto); 1355 (Lineback)
- 4848 BOTSWANA, RB; 0347, EG, barnyard sounds IS a/tune-in, ID in EG and Setswana, freqs, my most complete ID after many tries (Cunningham 10/13)+6
- 4850 CAMEROON, RC; 2300, EG/FR, nx in both langs, s/off (Purdue 10/9)
- 4855 COLOMBIA, R. Bucaramanga; 0930, SP, ID, full freqs (Trotto)
- 4856t INDONESIA, RRI/Palembang; 1130, IN, short nx followed by pause, ID, no mention of Palembang (Barto 10/22)
- 4860 VENEZUELA, R. Maracaibo; 0145, SP, rock mx, full ID (Trotto)
- 4865 COLOMBIA, LV del Cinaruco; 0333, OM w/tx, maybe nx, mentions of CARACOL and Bogata (Jordan 10/29); 0015, two OMs, nx, time pips, mx IDs (Desrosiers 10/2)
- 4870 BENIN, ORTB; 2215, drama px (Field 10/5); 0525, FR tx (Plotnick 11/7); 2106, Afro mx, even "Little Town of Bethlehem" (Enkenhus 10/10); 2155, ID, into chimes, more tx, into mx (Desrosiers 11/6)
- 4870 ECUADOR, R. Rio Amazonas; 1010, SP, soft mx (Cobb 10/9)
- 4875 BRAZIL, R. Jornal do Brazil; 2312, PT, excerpts from various pop vocals w/tx, several IDs, poss. nx 2332 (Gliksman 10/11)
- 4875 COLOMBIA, R. Super; 0815, SP, off frequency (measured 4875.9) w/ID, usual px (Alexander 11/6)
- 4875 INDONESIA, RRI/Sorong; 1230, IN, YL vocals (Lineback 10/16)
- 4880 SOUTH AFRICA, SABC; 2155, AK, relig. px w/tx and mx, 2200* w/NA, time pips and off (Alexander 10/18)
- 4885 BRAZIL, 2 stations noted, mx px at 0850, ID "...onda tropical...kHz...Acreana???) not sure about last word in ID (Field); 0901, s/on Radiodif. Acreana, ID hrd 2X (Field 10/28)
- 4885 PERU, R. Huancavalica; 0930, SP YL/OM, mx, 0932, birthday song played (Bolland 10/18); 1030, Peruvian mx (Field 10/5); 1033, Andean mx, OM anmts (Moore 10/13)
- 4890t ECUADOR, Centinela del Sur; 0338, live sx event, maybe futbol, //4920 and 5060, maybe R. Quito net (Gliksman 11/9+12)
- 4890 PAPUA NEW GUINEA, Port Moresby; EG, 1cl and world nx at 1207, including a story abt Connecticut man whose Guinness Book of World Record pumpkins were smashed by vandals (Enkenhus 10/10); 1039-1110, EG (Niekamp 10/15); 1205, EG (Cunningham 11/1); 1056-1355 (Trotto, Lineback, Churuszy, Gilster)
- 4890 SENEGAL, RS; 2317, FR, Afro mx w/full ID at 2321 as "Senegal International," then mx (Bolland 10/18); 2330 (Plotnick 10/29); 0000, OM, YL w/ID, nx, Afro mx, very upbeat (Desrosiers)
- 4895 BRAZIL, R. Bare; ID as "Radio Super, Bare," 0250, many promo IDs, EZL strings, sfx (Jordan 10/29); mx px 0016, normal voice ID and then echo effect ID by OM (Johnson 10/22)
- 4895 SARAWAK, RMS; Western-style pop vocals in Asian lang (Lineback)
- 4899 INDONESIA, RRI/Surakarta; 1120, IN w/anmts by YL, station ID (Barto); 1515, tx mx (Schulze 10/18)



LOG REPORT

section B

4900 to 6199 kHz

Editor: Jerry Berg, 38 Eastern Avenue, Lexington, MA 02173

- 4900 VENEZUELA R. Juventud, rock mx 0131 10-30 (Plotnick); pops to ID, NA, 0355*(Stanley-AZ).
- 4905 BRAZIL R. Araguaia, relig. prgm 0810 10-29, Br. pops, ID 0831, good (Glikman-IL).
- 4911 ECUADOR Em.Gran Col., nx 0320 11-1, promo, ID, weak, never easy (Cunningham).
- 4915 BRAZIL R. Anhanguera, talk 0024 10-15, full ID 0029, good (Johnson-TX); 0730(Alexander-PA).
- 4915 GHANA Accra, drum IS 0600 11-6, ID, nx, lang 0615 (Paskiewicz).
- 4920 AUSTRALIA ABC-Brisbane, sports, nx, 1210 10-30 (Alcorn-PA); pops 1350 (Lineback-TX).
- 4920 ECUADOR R. Quito, LA mx 0142 10-30, ID, good sig (Plotnick); IDs 0400, 0413 10-19, big band mx, fair (Stanley-AZ); "Voz de la Capital" ID 0416 10-15, instr. mx (Choroszy-ME).
- 4925 CHINA Harbin, CE talk and music, 10-22 at 1350, poor sig (Lineback-TX).
- 4932 NIGERIA Educ Svc, nx 2110 11-6, poor (Desrosiers-MA); speech 2150 11-4, drums, next day's prgm details, P-F (Bobb-MK); lecture, poetry, 2218 11-4, nx 2302, ID (Pickard); EG test prgm 0520-0615 10-20 (member's name illegible); soul, gospel mx 0525 10-15, RN ID 0531 (Alexander-PA); 0546 10-13, better than 4990 (Valko); RN nx 0600 10-14, prgm //4770 (Glikman-IL); probably Lagos now, not Benin City; we'll see (JB).
- 4940 IVORY COAST Abidjan, long FR talk 2125 11-7, no ID, hvy QRM, fair sig (Plotnick).
- 4940 UKRAINIAN SSR Kiev, Ukr 0020 11-7, class. mx, opera, low audio, ID 0114, fading badly, almost gone 0130 (Desrosiers-MA); unid. RS stn, talk, 1225 10-23, poor (Lineback-TX).
- 4946 COLOMBIA Caracol Neiva, LA mx, ID 0147 (Plotnick); talk, laughs, 0205 10-29 (Jordan).
- 4945 BRAZIL Rdif. Pocos de Caldas, 0928 10-6, good with talking by man, many mentions of Radio Bras, into mx; under Caracol the whole time, but still good.
- 4950 SARAWAK Kuching, EG nx at 1430 11-7, Malay ID 1440, patriotic song, talk on agric (Sharpe-CA); DJ with piano mx at 1515 gm 11-5 (Vadino).
- 4955 BRAZIL R. Marajoara, poor at 0905 on 10-18, talk, ads 0909, sports 0910, fading by 0915 (Bolland-FL); caught ID with some jingles, 2301 on 10-11 (Glikman-IL).
- 4955 BRAZIL R. Cl. de Rondonopolis, ID 0132 10-2, mx, relig. prgm 0200 (Field-MI).
- 4955 PERU R. Cultural Amauta, mx 1015 10-26 to 1045 fade, ID hrd (Field-MI); bible readings and hymns 1016 10-16, ID 1035, "Onward Christian Soldiers" in background (Moore-HOND).
- 4965 HONDURAS Presumably R. Landia, or other stn in Comayagua, *1100 11-19 with "La Gran Alvorada Ranchera" prgm; ranchera mx, TCs, ads, promo, no ID but mentions of Comoy. Not hrd 11-20; 11-21, *1100, no talk, xmtr breaks (JB, tnx to telcall from Max Greenwood).
- 4970 SABAH Kota Kinabalu, pops 1450 11-7, gal anncrs, some local artists, 1600*(Sharpe-CA).
- 4970 VENEZUELA R. Rumbos, ID 0255 10-18, LA mx, vocals, amnts, hvy QRM, poor (Stanley-AZ).
- 4975 COLOMBIA Ondas del Ortega, mx at 1000 on 10-20, time checks, ads (Field-MI).
- 4980 VENEZUELA Ecos del Torbes carrying LV del CID prgm 0123-0134, talk, sked, ID, slow version of Cuban NA; good 1020 (Gavaras); CID nx ending 0145 10-4 (Trotto-FL); LA mx, singing, ID by man, exc sig 10-30 at 0153 (Plotnick).
- 4990 CHINA Changsha, CH talk by man, 1220 10-23, fair sig (Lineback-TX).
- 4990 SOUTH AFRICA R. RSA, "Cud Morn Afr" EG 0407 10-15, Broadway tunes, good (Choroszy-ME).
- 4990 VENEZUELA R. Barquisimeto, 0015 10-30, amnts, talking, ID (Plotnick); LA mx with male DJ, 0155-0230 10-31, many IDs (Sharpe-CA); ID 0205 10-31, vocals, guitar mx, ads, fair sig (Stanley-AZ); Beatles mx 0310 10-26, almost non-stop for half hour (Burke-VA).
- 4996 ECUADOR R. Baha'i, in here with full ID at 0203 10-1, mx, comments; poor (Bolland-FL).
- 4997.5 UNID. On tip from Bob Hill, PT speaker, seemingly African; talking 2035 11-11, ID 2100 but couldn't get, pops, combo mx; think Luanda mentioned; R.Nac. Ang on the move?(JB)
- 5005 EQUATORIAL GUINEA Tent. Bata, Afr mx 2215, s/off amnt, NA (same as Malabo's) to 2223*; SP; only day I've hrd this in a long time, 10-11 (Glikman-IL).
- 5005 SARAWAK Sibul, talk by woman in unid. language, 1340 10-22, poor (Lineback-TX).
- 5013.5 UNID. Ballads 2040 11-12, rapidly fading, gone by 2100; Em. Prov. de Namibe, ex-Mocamedes, Angola, rptd here overseas at *0500v and 2300*, but just a guess. (JB)
- 5015 BRAZIL R. Cultura, romantic mx 0205 10-15, IDs by CM 0216, 0237 (Glikman-IL).
- 5015 ECUADOR Esc. Rdifon. Pop, Andean vocals at 0257, full ID 0300, good sig several eves (Glikman-IL); 1010 10-7 in Indian lang, SP ID 1015, back into lang (Field).
- 5015 PERU R. Moyobamba, 10-6, mx at tune-in, NA, ID at 1037 (Field-MI); 1039 10-20, poor with talk, reverb mike, huaynos, etc. (Bolland-FL).
- 5015 USSR Vladivostok, talk by man in RS at 1330, 10-22, fair sig (Lineback-TX).
- 5020 SOLOMON IS. Honiara, M&W anncrs 0940 10-15, ads, mx, fair (Niekamp-MN); EG nx 1102 10-15, mx 1107, poor (Bolland-FL); EG DJ show 1112 10-17, US pops, ID, NA, 1130*; poor in hvy QRM (Gilster); pops 1115 10-3, ads, hymns, devotional, 1130* (Erkenhus-MD).
- 5025 PERU R. Quillabamba, talk 1044 10-22, poor, mx; fades out to nil at 1100 (Bolland-FL).
- 5027 UGANDA Kampala, 0311-0348 10-13, 0320-0418 10-29, Afr mx, gal anncr, many IDs but frequent breaks in signal; pips 0330, nx (D'Angelo-PA); mx 0327 10-21, pips, ID, maybe vernac. nx; EG nx 0400, poor but with little interference (Johnson-TX); 0400 10-29 gave time as 7 AM Eastern African Time, then African nx; local nx 0405, ID 0410, more nx;

- good level this night, but much QRM (Cunningham).
- 5030 BOLIVIA R. Cuarto Centenario, Tupiza, 1108-1121 with true Bolivian folklorico, DJ with IDs, march mx, ads 1116; very slick, and big sig on 1020 (Krueger-FL); tent. this one on 10-23 from 0050 to past 0300 with sports; weak, no ID; also 10-24 at 0035, man talking, I think they signed off 0117 (Field-MI).
- 5030 PERU R. Los Andes, talk and mx at 1014 10-9, also 0940:10-19, ads, lots of mentions of Huamachuco, good sig, believe prgm is "Vernaculares Huamachuco" (Bolland-FL); 1015 on 10-9, OA mx, M&W anncrs, ad string, ID, strong sig (Alexander-PA).
- 5030 SARAWAK Kuching, good with EG talk at 1200 on 10-23 and 1325 on 10-22, fair at 1215-1230 on 10-16 with western instr., pips, 1230 ID by gal, into mx by man (Lineback-TX).
- 5035 HAZAREH SSR Alma Ita, 1120-1150 10-22, fair, RS M&W, mx to 1025, then talk, the usual talk-plus-occasional-mx, "weariness" programming (Bolland-FL).
- 5039 SUDAN Omdurman, ID in AR at 10-22, folk mx; poor, but active agn(Wood-S.AR).
- 5040 COLOMBIA R. Cincos, fair 10-19, mx 0020, IDs, ads, talk, disappeared 0044 (Bolland-FL).
- 5045 BRAZIL R. Cultura do Para, in PT 0140 on 10-8, low audio, sports event, very excited anncr (Desrosiers-MA); 0815 10-8, mx, talk, reverb mike during ID, good (Bolland-FL).
- 5046 INDONESIA RRI-Jogjakarta, poor with gal talking in Indonesian, 1320 10-22 (Lineback-TX).
- 5050 COLOMBIA LV de Yopal hrd lately, usually 0100* with mx before s/off, sometimes no closing anmt, just NA (Field-MI).
- 5050 ECUADOR R. Jesus del Gran Poder, EZ lstng mx at 1115 on 10-24, ID by gal followed by short talk, hvry QRM; poor-fair (Gilster).
- 5050 VENEZUELA R. Mundial is back, exc at 0530 on 10-30, upbeat LA vocals, talk, laughter by 2 OM DJs, plenty of promos, many mentions of "Mundial," full ID with QTH at 0400 (Cunningham); 0353 10-30, pops and local vocals, jingles, singing IDs, slogan as "MYKE Mundial;" VG, but RTTYed at 0428 (Stephany-NY); weak 0421 10-30, mx, ID (Rigas-IL).
- 5052 SINGAPORE R. Singapore, fair with EG mx at 1300 on 10-22 (Zilmer); 1315 on 10-22 with EG talk and mx, poor sig (Lineback-TX).
- 5055 COSTA RICA TIPC, EZ lstng mx at 0204 on 10-18, PSA for their version of AA, ID 0227, talk 0230, all SF, fair-good (Niekamp-MN); EG ID 0300 with times and fqys, "Hour of Decision," interview, relig.songs and mx, poor on 10-17 (Stanley-AZ); sermon on evils of alcohol at 0332 on 10-21 (Thunberg-PA); SP preaching 1155 10-23, fair(Lineback-TX).
- 5057 ALBANIA R. Gjirrokaster, good 0436 10-15 with folk mx, gal anncr (Choroszy-ME).
- 5063 ECUADOR R.Nac.Progreso, 0439 10-30, male DJ with TCs, local songs, escho anmts, final ID 0500, NA to 0503*, good-VG with RTTY QRM (Stephany-NY); 0943 10-8, good sig, mx, ads, full ID 0953; noted anywhere from 5061 to 5066 (Bolland-FL); ads at 1030 on 10-6, references to Loja (Field-MI).
- 5067 ZAIRE Tentatively R. Candip, stumbled into mellow musical IS to 0330 on 10-29, brief liting mx, opening anmt, definitely FR; bit of talk, then Afr vocals; definitely there, and //3390, but just too weak for any intelligibility; quick fading (Cunningham).
- 5095 COLOMBIA R. Satuzena, 0200 on 11-2, up-tempo instr.mx, male anncr (Sharpe-CA).
- 5105 CLANDESTINE LV del CID, ID 0200 on 10-4, then general info (Jones); anti-Castro talk at 0217 10-26, chimes, guitar mx, good sig (McLemore-FL); 0240 on 11-5, talk, march mx, good IDs, unusually strong sig and audio; list of CID stns, freqs, 0250* (Desrosiers-MA); M&W anncrs 0604 10-22, ballads, ID and talk (Alexander-PA); 0946 on 10-19, two men talking about comies and economics; full ID 0948, fair sig (Bolland-FL).
- 5112 PERU R. Eco, 1005 on 10-22, SP mx, TCs, talk, fair sig (Bolland-FL).
- 5170 CHINA PLA stn, seemingly a play in CE, 1250-1300 on 10-30, exc sig (Lineback-TX).
- 5265 CHINA PLA stn, in Amoy maybe, 1102 on 10-18, gal anncr, talk, strong (Choroszy-ME).
- 5265 CHINA PLA stn again, 1250-1300 10-30, semi-clas.mx, //5240, both nice (Lineback-TX).
- 5268 CHAD R. Moundou, tolerable at *0457 11-12, 3-note IS, anmt 0500, into N.Afr mx, bit of talk here and there; vry low audio during talking; stayed with em till 0536 (JB); weak with mx at 0500, 10-25, het (Field-MI); *0501 10-21, 3-note IS till 0503, NA, Afr mx, gal in FR 0506, lively pops at 0512, ID after song; usually badly QRMed, but audible (though poor) this night (Valko).
- 5360 PERU Radio Vision, 0241-0259 on 10-19, EZ lstng mx, Andean style, frequent IDs, mentions of San Martin (Gliksmn-IL); folk mx, man host, 0332 10-30, sudden 0344* in mid-speech; fair-good (Stephany-NY); ID at 0339 tune-in 10-20, LA mx, but fading quickly (tho not a bad sig) (Konen-WI); mx 0415 11-2, ID and TC 0430 (Field-MI).
- 5451 W. IRIAN RRI-Biak, mx 1250 10-7, IS, ID, mx abt Biak; fair sig (Bobb-MN).
- 5770 CHINA PLA stn, woman talking 0940 10-4, 0945 mx, more talk, sig breakup(Berryman-NY)
- 5882 ARGENTINA R. Rivadavia, mx at 0010 on 10-4, ID 0030 (Field-MI); 0031 on 10-8, sports talk by 2 anncrs, fanfare 0032, then anmts mentioning Argentina, more deportes; call, fqy at 0040, "R. Rivadavia" ID, yet more sports; good level (Cunningham).
- 5895 BELGIUM BRT, man talking abt Belgium, EG, 2203 on 11-4 (DiBiase); talk on intl broadcasting at 2215 10-31, EG; Flemish mx, sports (Alcorn-PA).
- 5905 USSR RM, probably Polish 2150 on 10-17, piano, fqys 2159, EG 2200, F-G,QRN (Gilster).
- 5910 BELGIUM BRT, EG to N.Am at 0030-0115 on 11-7, //9980 which is beamed to S.Am; 11620 was dropped; poor sig, little QRM (Zilmer).
- 5920 USSR RM, RS talk by M&W, OM QRM, 0250 on 11-1 (Plotnick).
- 5930 CZECHOSLAVAKIA Prague, EG nx, talk, local mx, 0100 11-2, //7345, 11800 (Zilmer).
- 5935 LATVIAN SSR R. Riga, piano mx to 2128 on 10-6, pause, R. Riga ID 2130, three prgm segments followed; ID 2159, anncd next prgm on Saturday; fair (Enkenhus-MD); weak at 2123 on 10-22, classical mx; into Swedish at 2130 (Rigas-IL).
- 5945 AUSTRIA Vienna, ID 0129 11-3, nx, talk on UN, good sig (Dillon-PA); "Austria Calling" 0129-0156 10-16, EG, "Fprt from Austria," etc (Krist-VA); 0130 10-21, nx, cmtry, "Focus" on a vocal group (Fraser-MA); GM talk, mx, ID, 0230 10-17 (Plotnick); EG at 0330, 10-17,

- IS, "Sports Roundup," bad het on fgy; poor (Stanley-AZ); EG to 0456 close, fair sig on 10-16 (Trotto-FL); GM cetry, 2225 10-24 (Alcorn-PA).
- 5950 GUYANA GEC, EG 0700 on 10-26, but vy poor until came out of slop at 0800 with "Early Bird Show," lots of TCs, greetings (Burke-VA); ads, TCs, fair at 0843 on 10-10 (Fields-IL); sports nx from Guyana at 0953 on 10-19, ads, good sig (Bolland-FL); relig. sermon about condx of man today, 1020 10-9 (Bolland).
- 5950 NICARAGUA Voice of Nicaragua, EG nx 0100 on 11-6, back into SP at 0107, fair sig (Hewitt-FL); EG talk about Nic festivals, ID 0145 as "Land of Sandino"; "We Don't Want War" followed by "Nic Today" (Field-MI); end of EG nx 0156, 10-19, anti-US slant (Burke-VA); YL with cetry on how to solve CA problems, 0158, time pip 0200—"It is exactly 8 o'clock in revolutionary Nicaragua," into SP ID (Desrosiers-MA); SP political talk at 0340 on 10-17, fair sig (McKellar); SP ID 0500 on 10-16, then prgmng ended the carrier stayed on; no sign of EG (Burke-VA); IS consisting of organ tones at *1050 on 10-18, M&W with IDs until 1102, then prgmng started, fair sig (Obb-ME); IS 1059 on 11-8, M&W with armts, strong sig, all SP (Fields-IL); full ID 1130 on 10-20, TCs, into nx; good sig (Gilster).
- 5955 PERU R. Huancayo, 0957 on 10-31, lively vocal, yipping now and then, talk between songs with many mentions of Peru; two IDs noted; carrier from another stn on at 1009 causing severe QRM (Valko).
- 5960 CANADA RCI, EG ID 0300, world nx, wx, sports, talks, good sig (Stanley-AZ).
- 5965 MALAYSIA Kuala Lumpur, 1525-1545 on 11-7, modern Malay pop mx, TC, ID, nx, wx at 1530, then mx resumes, prayers at 1545 (Sharpe-CA).
- 5970 ITALY RAI, EG at 0100 on 11-7 to N.Am, nx, mx, //9575, replacing 11800 (Zilmer).
- 5975 COLOMBIA R. Macarena, 1018 in SP on 10-17, fair with full ID and ads (Rigas-IL).
- 5975 ENGLAND BBC WS, nx 0300 10-19, "World Today," "Discovery," good sig (Dillon-PA); BBC EG nx at 0703, ID 0705, poor sig (Berryman-NY).
- 5975 S. KOREA Seoul, EG mailbag at 1014 on 10-9, M&W, static, fading, co-ch.QRM (Park-HI).
- 5979 MEXICO XEJ, Linares, Mex style vocal and instr.mx, talks and promos by M&W between selections, frequent TCs and giving QTR as Apartado Postal 62, Linares, Nuevo Leon. Complete ID by man, with fgy given (tent.) as 5980, at 0924, 0945; weak but mostly in the clear except for some Macarena splash. Unusually early log of a Mexican; I assume a one-day thing rather than a regular sked (Cunningham). Others have hrd at this hr too
- 5980 COLOMBIA R. Nacional, 0953 on 10-23, s/on with NA and complete ID (Field-MI); (JB). *0956 10-21, theme, complete ID with QTR and MW fgy, then NA, opening ID, into cultural prgm of some sort (Cunningham).
- 5980 SOUTH AFRICA R. RSA, 0200 on 10-14, IS, ID, Afr and world nx, "Spotlight," a look at S.Afr and Israel, "Letter from S. Africa"; good sig (Stanley-AZ).
- 5980 TAIWAN Voice of Asia, 1137-1201 on 10-20, fair with gal in EG giving IDs between exceptionally stagnant elevator mx; into IN at 1200 (Krueger-FL).
- 5990 ITALY RAI, *0445 in IT, IS, ID, then into nx (Trotto-FL).
- 5995 AUSTRALIA RA, fair 10-13 at 1027, ID, man giving new fays, "Waltzing Matilda," songs (Krist-VA); rock mx at 1136 on 10-20, feature on robots, ID at 1159, good sig (Gilster); "Music Showcase" at 1330 on 10-16 (Pirnat).
- 5995 MALI Bamako, M&W talking in FR at 2130 on 10-17, seemed nx; poor (Plotnick).
- 5995 USA VOA, EG "New Horizons" with nx on new products, 10-17 (Gaffin).
- 6005 S. YEMEN Aden, hrd as early as 0300 (WETH listed s/on time) to past 0400 with seeming nx, also mx. ID with reference to Aden on quarter and half hr; behind BBC to 0350, then clear till BBC comes back 0355 (Field-MI); 0349-0356 on 10-6, nice sig with AR mx, M&W talking, ID, wiped out by Vatican carrier at 0355, still hrd beneath (Valko).
- 6005 CANADA CFCX-Montreal, US pops at 0824 on 10-9, DJ patter, nx on the hr, fair-good sig (Niekamp-MN); man with ID 1115 10-15, ads, TC, wx, mx, sports, nx, poor-fair with fading (Bobb-MN); 11-1 at 1245 with "Big Al," nx, traffic, mx, ads for cars, good sig (Desrosiers-MA); vy weak at 1917 on 10-13, 1stnr letters, ID as R. Montreal (Burke-VA).
- 6006 COSTA RICA R. Rolo, 0645 on 10-30, mx, ID, first time hrd in a month, gud sig (Trotto-FL).
- 6010 SINGAPORE BBC PES, YL with mx prgm seemingly in CE at 1303 on 10-21, talking 1327, FL. off with no fanfare at 1330, poor sig (Lausevich).
- 6010- VENEZUELA R. 104C, SP songe at 0845 on 10-9, ID, armts, fair but het appeared at 0853 (Alexander-PA); IDs by M&W at 1010 on 10-24, frequent armts, into mx, with another SP stn underneath (probably R. America-JE) (Ware).
- 6015 NORWAY Oslo, 1600 with Norwegian nx, 10-22, //15175, 21715, 21730; fair (Wood-S.AE).
- 6015 VATICAN Vatican Radio, EG at 0056 on 10-14, mailbag-type prgm with notes on receivers; into interview at 0102, good sig (Gilster); 0055 on 10-20, Pope speaking and gal interpreting, good sig (Trotto-FL).
- 6025 BOLIVIA R. Illimani, M&W arnncs, 0906-0933 on 10-9, chit-chat between records, Andean style flutes and guitars, poor sig (Niekamp-MN); 2254 on 10-13, LA vocals, some US pops, gal arnncr with "R. Illimani" ID with fays; poor overall (D'Angelo-PA); nx with frequent reference to "informa Cola Cola" at 2345, ID 0030 (Field-MI).
- 6025 NIGERIA FRCN-Enugu, man with varied Sunday eve mx prgm at 2205 on 10-16, talk mentioned "we Africans"; very poor-good, noisy, in Ibc and EG; to 2304* (Bobb-MN).
- 6025 PORTUGAL Lisbon, PT nx but vy weak at 2045, 10-18, had to use SSE (Burke-VA).
- 6030 CANADA CFCX-Calgary, wx 0035 10-19 (Hazeltine). CFCV, right? Or CFCX-6005? JB.
- 6030 USA AFRTS, world series play-by-play, 6-second time lag over TV coverage, good (Gilster).
- 6035 AUSTRALIA RA, EG ID at 2030 on 10-18, into Australian nx (Burke-VA).
- 6035 BRAZIL R. Globo, talk by man, ID, singing ads, 2245 on 10-22 (Prath-FL).
- 6035 LIBERIA VOA, 0300 10-11, good with IS, ID, world nx, "African Safari," rpt on Israel's economy (Stanley-AZ).

- 6040 ANTIGUA DW relay, IS at *0055 on 10-9, "Caribbean relay" IDs, nx, mx, "Focus on Bonn," very good (Lausevich); 0100 10-20, IS, ID, nx, "Microphone on Europe," press review, etc. (Stanley-AZ); ditto, 11-4, good sig (Dillon-PA); EG 0100-0107 10-19, fqys, ID, world nx (Gaffin); good 0132 10-14, "Spotlight on Modern Life" (Gilster).
- 6045 USA WRNO-New Orleans, pop mx 0224 11-8, IDs, 1984 World Expo official str (Ware); rock mx 0236 on 11-8, believe that's the 1984 World's Fair (Rigas-IL).
- 6050 MEXICO FRCN-Ibadan, talk 2205 10-11, ID, pop mx, EG; poor-fair (Bobb-MN).
- 6050 USSR RM in EG on 10-30, 0722-0747 with nx, Moscow Mailbag, etc. (Sharpe-CA).
- 6060 ARGENTINA R. Nacional, 0945 10-9, quiet songs, theme mx, ID 0959 (Niekamp-MN).
- 6060 AUSTRALIA RA, "Australian Insight" good at 1315, 10-5 (McKellar).
- 6060 PERU R. JSV, musica Peruana 1126 10-6, ID and TC 1130, fair sig (Moore-HOND).
- 6063 PORTUGAL Lisbon, EG 10-30 at 0305, talk on imports, price index (Alcorn-PA).
- 6070 CANADA CFRX-Toronto, mx, ID, ads, 1810 10-29 (Plotnick); ditto 2000 10-18 (Dillon-PA).
- 6075 COLOMBIA R. Sutatenza, nx, ID 1015, on 10-25 (Field-MI).
- 6075 GFR DW, gal talking in GM, 1820 on 10-29 (Plotnick).
- 6080 CHILE R. Patagonia Chilena, seemed just s/on 1003 10-11, ID 1004, nx, gone by 1020 (Stephany-NY); tent., mx 0952 10-22, nx 1000, no ID noted (Field-MI).
- 6085 ANTIGUA DW relay, *0158 10-17, strong, EG ID at s/on, into GM program (Enkenhus-MD).
- 6085 COLOMBIA Ondas del Darien, LA mx 1215 10-29, TC and ID by man (Prath-FL).
- 6085 GFR Possibly Bayerischer Rundfunk, 0730 to past 0900 10-7, pops, GM mx, jingles, tel. requests, ads, nx on the hour; poor sig (Trotto-FL).
- 6090 CUBA Havana, EG 0227 on 11-8, talk on Grenada, returning Cubans (Rigas-IL).
- 6090 GUATEMALA TGMUB, mostly pops, relig.vocals, occas.talks; ID, QTH, fqy at 1117 10-22, call ltrs at 1138 (Cunningham); fair 1115 10-24 but distorted audio, ID 1130 (Field-MI).
- 6090 LUXEMBOURG RL hrd by several in the 0000-0200 period, EG, rock mx (Burke-VA, Trotto-FL, Moman-ALB, Purdue, Alcorn-PA); and at 0705 in GM (Summers-PA).
- 6095 ECUADOR HCJB, "DX Party Line" 0630 11-1, 0700*, little QRM frn VOA same fqy (Trotto-FL).
- 6095 POLAND Warsaw, 0200-0230 11-3, ID, nx, "Panorama," all EG; QRM frn DW 6100 (Enkenhus-MD).
- 6095 TANGIER VOA, poor in EG 0715-0725 11-1, ID, bus.nx, oceanography (Trotto-FL).
- 6105 MEXICO Su Pantera, US pops, numerous IDs, 0440 10-9 (Konen-WI); mx, ID, fair and noisy 1200 10-22 (Bobb-MN); LA mx 1230 10-8, mentioned their QTH (Prath-FL).
- 6110 PHILIPPINES VOA, poor 1225 10-23, EG "Critic's Choice," nx 1230 (Trotto-FL).
- 6120 ARGENTINA R. Nacional IDs 0900 10-9, taken over from El Mundo; //6060 (Alexander-PA).
- 6120 NICARAGUA R. Zinica, TC and mx 1124 10-12, ID, P-C (Bobb-MN); relig.prgm in EG 10-23, 1315, man spoke EG like Ricky Ricardo; Zinica ID and into SP at 1335 (Prath-FL).
- 6130 CANADA CHNX-Halifax, nx, sports, wx, IDs, ads, the usual, 0800 11-7 (Summers-PA), 0810 11-8 (Fields-IL), 1825 10-29 (Plotnick), and 2304 10-15 (D'Angelo-PA).
- 6135 BRAZIL R. Gaucha, sports 0045 10-20 (Field-MI); ID, ads 0915 11-6, //11915 (Alexander-PA).
- 6135 SWITZERLAND SRU, EG at 0145-0215, IS, ID, TC, nx, various reports, Swiss mx, PA). fair sigs (Bonnet-IN, Krist-VA, Stanley-AZ).
- 6140 FRANCE RFI, FR nx, talk, 0140 10-16 (Jones).
- 6140 PERU R. Huayllay, Andean mx, IDs, TCs, fair at 1103-1125 10-6 (Moore-HOND).
- 6145 GFR DW, EG at 0100, IS, ID, nx, various features, GM lessons (Krist, Stanley, Jones).
- 6150 COSTA RICA R. Impacto, 0955-1010 on 10-29, mix of SP and EG EZ ltnsg mx, IDs by man, very good sig (Ware); US rock mx at 0630 on 10-26, good sig (McKellar).
- 6155 AUSTRIA Vienna, at *0500 10-3, IS, ID, nx in GM (Trotto-FL).
- 6155 SINGAPORE Tent. R. Singapore, India-Pak sports event 1210 10-17, Malay lang (Bobb-MN).
- 6160 CANADA CKZV-Vancouver, jazz, closing armt with ID, NA at 0805, to 0806* (Alexander-PA); pops at 1240, TC, B.C. and Vancouver wx report, ID, fair 10-11 (Bobb-MN).
- 6160 CANADA CKZN-St. John's, *0828 on 10-26, two anthems, ID, wx, nx, TCs, sports, mx, poor-fair (Bobb-MN); "Morning Show" 0958, CBC nx, TCs, mx, wx, local nx, 10-27 (Krist-VA); CBC relay 1324, roundup of weeks nx frn Newfoundland and Labrador, wx, fair (Enkenhus-MD).
- 6165 NETH. ANTILLES RN-Bonaire, 0230 on 10-14, IS, ID, "Newline" current affairs prgm, talk on world hunger, "Friday Rpt.", "Media Network", P-G (Krist-VA, Stanley-AZ).
- 6170 ALASKA KNLS-Anchor Point, 1201 on 10-7, s/on armt with address in EG, "Chariots of Fire" theme, Mandarin by gal, Blue Danube waltz; fair sig (Konen-WI); man with ID in CE at 1203 10-5, also EG ID, fair-good (Bobb-MN); 1211-1231 10-5, EG, Mandarin, EZ ltnsg instrumental mx, classics and contemporary; EG ID with address at 1230, gal with Mandarin then; fair (Valko); 1256-1301 10-16, good with CE-EG language lesson, ID, mailing address, into CE talk (Lineback-TX).
- 6175 ANTIGUA BBC, 0700-0720 on 10-26, "24 Hrs" nx feature, press review, good (Sharpe-CA); WS nx, "The World Today," good at 0300-0330 10-18 (Dillon-PA); world nx 0303 on 10-11, good rcpm (Bonnet-IN); EG nx 0620 on 10-25 (McKellar).
- 6180 VENEZUELA R. Turismo, possible s/on at 0909 on 10-26, NA-type march, several IDs by man, fqy, call letters, into "musica nacional" prgm (Ware); good at 1012 with IDs, TCs, fast paced LA mx with equally fast paced anncr, IDs between most tunes, fair 10-11 (D'Angelo-PA); LA mx 2330 10-17, Valera QTH mentioned, BEC-6175 QRM (Prath-FL).
- 6185 BRAZIL R. Bandeirantes, Br. mx, ads 0840 10-16, //9645, 11925 (Alexander-PA).
- 6186 PERU R. Orientes, man talking 2310 10-19, many mentions of Huamanga, but QRM moving in as time goes by; mx 2351, fair (Bolland-FL). Do you mean Yurimaguas? JB.
- 6195 CANADA CBC NGS, 0500-0508* 10-15, ID, CBC nx, wx, NA, a little FR (Mayer-PA).
- 6200 PERU LV de Huamanga, OA mx, yipping, 1033-1042 10-31, TCs, IDs, a little above 6200 (Valko); VG 1034-1042 10-10, apparent *1030 (Krueger-FL). +++ 73 & Happy Holidays



LOG REPORT

section C

6200 to 11699 kHz

Editor: David L. Walcutt, 211 West 56th, Apt. 38-F, New York, NY 10019

- 6210.0 CLAND V. de Sandino; 0110 EG, rev. slogans, IDs as V. of Sandino/V. of Free Nicaragua, gunfire (Alexander-PA 11/6); 0050-0056* EG, unid., gun shots (Alcorn 10/29); 0404-0434 SP, nx, rev. talk, LA mx (D'Angelo 10/16); 0458 SP into EG for "Atlantic" coast of Nicaragua, followed by presumed Miskito; no lower sideband (Walcutt).
- 6215.6 LEBANON V. of Hope; 1800 EG mx, f (Wood-ARS 10/15); 2250 EG, pop mx, caught ID as "This is the V.O. Hope" and then "Lebanon" (Prath-FL 10/10); fqy: dlw.
- 6220 CLAND V. de Sandino; 0544 SP, usual rhetoric, guns (Fisher 10/26).
- 6230 AFGHANISTAN R. Kabul; 1430 Dari political tlk, g (R. Wood 10/20).
- 6240vv CLAND V. of the Broad Masses of Eritrea; 1805 Oromo political tlk, good when unjammed; 6240-70v (R. Wood-Saudi Arabia 10/15).
- 6250 VATICAN VR; 0656-0732 IT/FR/EG/SP, ID, tlk (DiBiase 11/2).
- 6260 CHINA Qinghai PBS; 2307+, presumed the one thru crashing static; China opera & instrumental mx, W ancr in CH (Reinstein 11/4).
- 6271.9 PERU R. Guayabamba; 0228-0308* SP, nondescript ballade, ID and mention of Departamento Amazonas, into NA; fair (Krueger 10/15).
- 6276 PIR "KQSB International"; *0457-0508*, synthesizer IS, s/on, rock mx, abruptly off; poor (Arthur-HI 10/30).
- 6340 TURKEY Türkiye Polis Radyo; TK ID, Turkish mx; g (Wood 10/20).
- 6364.1 PERU R. Moderna, Moyobamba; 1057-1108, good just after s/on: "... Departamento de San Martín, R. Moderna... Desde la ciudad de Moyobamba" into Quechua-style vocal, huaynos (Krueger 10/20).
- 6580 USSR RP&P; 0000 FR, IDs 0000 and 0007, nx, M ancr (DiBiase 11/2).
- 6616 VIETNAM Bac Thai 1133+ heard daily varying +/- 2kHz.; mostly Viet mx & M ancr w/ments of "Vietnam"; f at best (Reinstein 10/30).
- 6790 SOMALIA R. Mogadishu; 0050+ very strong & apparently running all night today; mostly mx w/plucked strings & drums (Reinstein 10/21).
- 6850 CLAND R. Free Surinam; *0101-0132* s/on, drum mx, ID, Dutch dialect w/many ment Surinam and ohter stns. there (Gavaras 10/23). 0120 Tonga? pop mx, ID, g level but overmodulated (Konen 10/30).
- 6909.8 IRELAND R. Dublin Int'l; 0025-0810 EG, DJ pops (4 reporters).
- 7016.8v CLAND R. Farabundo Martí; 0108 anti-yanqui rhetoric preaching solidarity w/'el pueblo hermano de Grenada & statements from FPL leader "comandante Salvador Guerra" (Reinstein-FL 10/29); 7025v, ID by M at 0128, moved to 7041 at 0131 (Jones-TX 10/10).
- 7037.4 CHINA RB, RS Svc.; *2200 EIR to ID "Govorit Peking"; unjammed until 2205; //9945 much stronger signal (Reinstein-FL 10/13).
- 7072 ALBANIA R. Tirana; 0024 EG, way off usual 7065 (Cunningham 10/8).
- 7090.5 PAKISTAN RP; Islamabad 0133-0200 presumed Urdu. Strong signal w/subcontinental mx & many ment. of Pakistan (Reinstein 10/11).
- 7120 ALBANIA RT; 0230 EG, IS, ID, future Albanian Soc'm (Stanley 10/21).
- *7120 SOMALIA R. Hargeisa; Somali nx 1000, //Mogadishu 6790. Now back here ex-11640v (which was heard all day *0300-1800* but never dual to 6790). Good. (Wood-Saudi Arabia 10/20).
- 7125 POLAND RP; *2230-2300* EG, "DX Club Pgm" wednesdays, tlk of Poland's problems (Krist 10/12, Cobb 10/26, Plotnick 10/31).
- 7140.2 PAKISTAN RP, Hindi Svc.; 0104-0130 hetting BBC 7140. Qur'an recit'n by M, subcont. mx., long tlks, drifting around 41 meter band. See 7315.4 (Reinstein-FL 10/11).
- 7160 MONACO TWR; 0640-0700* EG, rel pgm., "Back To The Bible", ID and switched to 9500 (Trotto 10/7); 0645 "BTTB"; little before end of program switched to 31 meter band; good signal (Field 10/20).
- 7175p SICILY RAI; 0459 IS, pips, pop mx, ARC QRM (Konen 10/17); *0459 IT, mx, tlk and news by M-W ancrs (DiBiase 11/4).
- 7215p IVORY COAST RTVI; 2350 FR, rock mx, partial ID, 0001* (Jones-TX).

- 7217.5 MOZAMBIQUE RM; 1615 PT, drama; good (Wood-Saudi Arabia 11/21).
- 7225 RWANDA DW-Kigali; 0430 EG, "Behind the News" (Paszkiewicz 11/03).
- 7235 GERMANY W. DW; 2315 GM, folk mx, //9735 netter (Prath-FL 10/22).
- 7240 MOROCCO RTVM; 0154-0205 AR, 0200 "Huma Ribat" by M & into world
 nx headlines; on 10/28 relayed Reagan's live speech followed by
 VOA nx analysis in Special EG (Reinstein-FL 10/22 & 10/28).
- 7250 SAUDI ARABIA BSKSA; *1800 anthem, Bambara, Qur'an, //15060; g
 (Wood-10/11). We appreciate your reports from ARS -ed.
- 7255 NIGERIA VON; 0500 EG, S/on w/Afr. mx & vocals, ID (Stanlet 10/10).
- 7265 GERMANY W. Sudwestfunk; 0545-0620 GM, soft chime-like IS (Jordan
 10/23); 0746-0803 Euromusic and ad string (DiBase 11/2).
- 7270 POLAND RP; 2229-2245 EG, "News Bulletin", top pop hits; f, //7125
 (Choroszy 10/9); 0202 EG, Grenada news; g (McLemore-FL 10/26).
- 7295 SWAZILAND TWR; 0355-0410 GM?, IS&ID heard loud & clear (McKellar).
- 7315.4 PAKISTAN RP; Hindi Svc., 0147-0215*, v. strong w/nice local mx;
 W ID "Pakistan Zindabad" 0213; anthem. Alternates with 7140
 (Reinstein-FL 10/19).
- 7320 USA VOA; 0620 EG, sports w/Jim Olsen, ID (Trotto-FL 11/1).
- 7335 USSR Domestic Svc.; 1116 RU mx & tlk mixing w/CHU; Khabarorsk
 per UHN; poor (Rigas-IL 10/26).
- 7345 CZECHOSLOVAKIA RP to N.Am.; 0100-0331+ EG (3 reporters).
- 7350 CHINA RB; *2300 Cantonese w/EIR, ID seemingly identical to WRTH
 listing; good here and //7590 (Reinstein-FL 10/13).
- 7352 CLAND LV del CID; 0135-0155 SP (Gavara 10/19, Jordan 10/25).
- 7355NF USA WRNO; 0053 EG, pop countdown (Rigas 11/7). 0159 to 6045 -ed.
- 7370 GREECE ERT; 1445 AR, nx, GK ID; g, //9420 (Wood 10/20).
- 7400 CLAND LV del CID; 0303-0410 SP (Lineback 11/26, Jordan 10/13).
- 7410 ISRAEL KI; 0001-0206 EG to N.Am. (3 reporters).
- 7417.5 PIR V. of Communism; 2358-0010*, annc phone (212)-283-9977, play-
 ing exclusively Beatles mx; once also IDed as "V. of Communism, V.
 of Democracy"; abruptly off (Rigas 10/29); 0306-0319 unid, jazz-
 funk mx, no ID's, maybe pirate out early for Halloween (McLemore
 10/30).
- 7433 PIR "KQSB INT'l"; 0358-0423* IS, M w/rock "bcng in 2 freqs" &
 Box 5074, Hilo, HI 96720 (Arthur-HI 10/30). See 6276 too... -ed.
- 7465 LV del CID; "Antonio Echeverria" station (3 reporters).
- 7491.5 CLAND V. Broad Masses Eritrea; 1700 Tigray ID; g (Wood 10/22).
- 7500 AUSTRALIA VNG; 0900 "This is VNG Lyndhurst, Victoria, Australia
 on 4.5, 7.5, and 12 mhz." Good. (Trotto-FL 10/21).
- 9009 ISRAEL KI; 2258 EG into Hebrew, nx, cw QRM (Desrosiers 10/23).
- 9022 IRAN VOIRI; 1930-1950+ EG, on war with Iraq (Hewitt-MI 11/6,
 Burke-VA 10/13, Jordan 10/29). Rufus your loggings are illegible.
- 9360 KOREA N. R. Pyongyang; 2115 EG to Europe, //6576 (Desrosiers 11/2)
- 9420 GREECE VOG; 0130 EG to N.Am., //9865 (Stanley 10/10, Zilmer 10/19).
- 9435 PAKISTAN RP; 1655 EG to UK, ID at 1700 into nx (Konen-WI 11/6).
- 9440 ISRAEL KI; 2000 EG, nx, sports Sunday; f (Zilmer 11/6).
- 9475 EGYPT R. Cairo; 0200-0300 EG, ID, mx, nx, cmtry, "From Papyrus
 To Paper" (Dillon 11/3); 0300 EG, lbx, distorted audio (Stanley).
- 9490 MONACO TWR; 0700 EG, here instead of ann'd 9500 (Field-MI 10/20).
- 9505 GJAM KTWR; 1400 EG, religious pgm; ex-9510; f (Zilmer 11/1).
- 9510 OMAN R. Oman; 1900 AR, ID, fanfare; mixed RFI; f (Wood 10/7).
- 9510 ROMANIA RB; 0400 EG, anti-nuclear movement report (Stanley 10/20).
- 9515 LESOTHO BBC W.S.; 0400 EG, IS, ID, world nx (Stanley-AZ 10/12).
- 9515p MALAYASIA RM-Kuala Lumpur; 1037 IN, just mx & cmnts (Bolland 10/8).
- 9515 TURKEY VOT; 2200-2250 EG, news, esp. of Turkey (6 reporters).
- 9520 PERU R. La Cronica; 1043 SP, Andean & Latin popular mx selections,
 frequent IDs "Radio La Cronica... Programa Accion" (Gliksman 10/9).
- 9525 POLAND RP; 0200 EG, nx, f after R. Habana off (Choroszy 10/10).
- 9535 CANADA RCI; 0200 EG, Larry Magne w/review of Panasonic (Stanley).
- 9535 NEH. ANTILLES TWR; *0400-0405 EG, IS, ID, s/on; g (Trotto 10/24);
 0435-0445 EG, mx, rel pgm; good signal (Giacodelli-NY 11/16).
- 9540 POLAND RP; 1620 EG, lbx; strong here (Choroszy-ME 10/10).
- 9540 VENEZUELA R. Nacional; 0100 SP, schedule annt. (Stanley-AZ 10/28).
- 9545 LEBANON R. Lebanon-Beirut; 1400 AR, ID, nx; g (Wood 10/6).
- 9550 CHILE R. Nacional; 0214-0230 SP, sports, ID (Roland Schube?? 10/16)
- 9550 ROMANIA RB; 0425-0430 EG, "Listeners' Letterbox" (Trotto 10/28).
- 9553 EL SALVADOR R. El Salvador; 0010 SP, LA mx, long M&W tx abt
 Nicaragua, Grenada; g (Prath 10/28); 0205 SP, LA pops, tlk by W,
 9553.2 (Alexander 10/23); 0205-0230* SP, political tlks (Jordan
 10/19); 0230-0236 SP, "Radio Farabino Nacional" (Schube? 10/16).
- 9560 KOREA N. R. Pyongyang; anthem, *1900 FR to Eur/Afr/ME (Wood 10/7).

9575 ITALY RAI; 0100-0120 EG to N. Am. (3 reporters).
 9580 AUSTRALIA RA; 1152-1300 EG to N. Am. (4 reporters).
 9585 BRAZIL R. Excelsior; 0110-0133 PT, futbol, //other Brazilians;
 no IDs so (t) but fits previous loggings (Glikeman 10/27).
 9585 HUNGARY RB; 2035 GM to Eur., nx; //11910 (Prath 10/23); 0200-0229
 EG to N. Am., "International Newroom" (Krist-VA 10/12).
 9590 GUAM KTRW; 1130-1200 EG/CH, rel tlks & mx (Schube? 10/18);
 1230 EG, conversation lesson during pgm in unid lang. (Zilmer).
 9590 NEPAL RN; *1147 Nepalese, IS, s/on by M at 1150, flute mx, lcl
 mx; competing w/Guam at about equal level (Konen-WI 10/13).
 9590 NORWAY NRK; 1700 EG/NW, ID, hx; g (Wood 10/4); 0030-0047* EG/NW,
 special test xmsn, mx pgm, ID at s/off; not SSB (Lausevich 10/27).
 9600 ASCENSION IS. BBC W.S.; 0500 World News (Park-HI 10/31).
 9600 USSR RM; 0225 EG, flight of 007 cmntry (Purdue 10/16).
 9605 VATICAN VR; *0000 SP, IS, nx (Prath 10/28); 0050 EG (Purdue 10/11).
 9610 AUSTRALIA VLW9-Perth; 1030 EG, local reports, "This is ABC Re-
 gional Radio" (Krist 10/12); 1402 lcl nx, f (Burke 10/13).
 9610 IRAQ RB; 2140-2205* EG, ID, cmntry, mx (Jordan 10/24, Bobb 10/21).
 9615 NORWAY RN; *2100-2140 NW, IS, ID, sports nx (Jordan 10/16).
 9615 VATICAN VR; 2215-2227* EG, pgm on St. Basil, ID, IS (Cobb 10/24).
 9615 SOUTH AFRICA R. RSA to N. Am., 0200-0250 EG (3 reporters).
 9615 USA KGEB; 1050-1255 SP, EZ-type mx (Bobb 10/18, Prath 10/29).
 9620 GERMANY E. RBI; 2130-2213 EG to Eur., nx, pops (Krist 10/12,
 Purdue 10/25); 2315 PT, nx (Prath 10/23); 2325 EG to Africa,
 news, current affairs, Soviet Union; f (Hewitt-MI 11/6).
 9620 NEW ZEALAND RNZ; 0950-1005 EG, orchestral mx from "Snowboat"; f
 (Enkenhus 10/19); 1219-1220*, amnt of freqs, anthem (Bobb 10/8).
 9620 YUGOSLAVIA RY; 1527 EG, IS followed by mx, //15240 (Vadino 11/5).
 9625 CANADA CBC N.S.; 1311 EG, economic reports (Krist 10/15).
 9630 SPAIN REE; 0000-0525 EG to N. Am., information pgms (5 reporters).
 9635 BRAZIL R. Aparecida; 0120 PT, mellow mx, 0130 ID (Cobb-ME 10/31).
 9640 ALGERIA RA; *2000 EG, ID ment. 4 freqs (Valko 10/10).
 9640 AUSTRALIA RA; 1400-1405 EG to Asia (Zilmer 11/1, Burke 10/13).
 9640 USSR RM; 0101 EG, about nuclear weapons in Europe (Purdue 10/11).
 9640 UK BBC W.S.; 0715, Review of the British Press (Trotto-FL 10/27).
 9645 BRAZIL R. Bandeirantes; 2345 PT, fast-talking ancr, ID (Cobb).
 9645 VATICAN VR; 2055 EG, rel tlk & mx, p (Bobb-MN 10/22).
 9650 GUINEA V. de la Rev.; 2250-0101* FR, long political talk/speech
 with applause until 2308 ID; into Afro mx (D'Angelo 10/10).
 9650 THAILAND RT; *2259 IS, ID, anc'd 9655; QRM GUINEA/USA (Schube).
 9655p PERU; R. Norperuana; OA mx, W ancr, could net get ID (Konen 10/30).
 9670 PORTUGAL IBRA-Sines; *1630 RS w/ID, religion; g (Wood 10/21).
 9675 JAPAN RJ; 1500 EG, IS, ID, M w/nx, "Current Topics" (Stanley).
 9675 USA KGEB; 1154-1200 JP, M w/ID, M&W tlk; f (Bobb-MN 10/17).
 9680 AUSTRALIA VLH9; 1202 EG, world & local nx & wx (D'Angelo 10/15).
 9690 IRAQ Saut ul Jamaheer; 0800 clock chimes, AR ID; //9505, also
 new; good (Wood-Saudi Arabia 10/18).
 9690 ROMANIA RB; *1930 EG, IS, with news; to Europe (Prath 10/23).
 9695 SWEDEN RSI; 2300 EG to N.Am. (Krist); 0230 EG to N.Am. (Stanley).
 9700 BULGARIA RS; 2232-0100 EG (5 reporters).
 9705 BRAZIL R. Nacional; light Brazilian pops, ID at 0857, more pops &
 what sounded like an ad for "Banco do Brasil (Glikeman 10/15).
 9705 MEXICO RM; 2300 SP, M gave freqs, call letters (Prath 10/23).
 9720 USSR RM; 2308-2334 EG, Grenada, Posner (Purdue, Gilster 10/12).
 9725 SWITZERLAND SRI; 0144-0145 EG, //6135, 11715 (Krist, Stanley 10/12).
 9730 GERMANY E. RBI; 2000 IT, cmntry (Hawk 10/16); 0014 EG (Krist).
 9730 SWAZILAND TWR; 0429 EG, IS, ID, program preview (Park-HI 10/31).
 9730 TURKEY TRT; 1945 unid lang., Turkish mx; p (Hawk 10/16).
 9735 PARAGUAY RN; 0135-1056* SP, 3 Italian opera selections (Jordan).
 9735 UK BEC; 2016-3030 Czech, nx, cmntry, good (Hawk 10/16).
 9740 CZECHOSLOVAKIA RP; 0315 EG, comment; f, heavy QRM (McKellar 10/11).
 9740 PORTUGAL RP; 0702* PT to Europe, "A Portuguese" NA (Wood 10/20).
 9740 SINGAPORE BEC W.S.; 1300 "World News" etc. (Krist 10/22).
 9745 CAMEROON RC; 2101 EG, nx of the region, "This nx is broadcast in
 the National Svc. of R. Cameroon"; overwhelmed by (presumed) Iraq
 at 2116 (Cunningham 10/22); 2230 FR, group vocals w/local instru-
 ments, heard under Ecuador (Jordan 10/19); 2245 FR/EG, mx until
 2300; ID "R. Nat'l du Cameroon" followed by nx in FR & EG, then
 more music; //4850 (Vadino 11/5).
 9745 ECUADOR HCJB; 0225-0550 EG, rel (Krist-VA 10/30, McKellar 10/15).
 9750 ALBANIA RT; 0000 EG, //7065 (Prath); 0230 EG (Stanley-AZ 10/16).

- 9749.5 TANZANIA V. of Tanzania; 1613 EG, program preview including "Liberation Programs to S. & C. Africa"; into "Sweet Leilani"; good (Wood 10/15).
- 9750 KOREA S. RK; 1400 EG, nx, anti-nuke protests (Burke-VA 10/24); 1402 EG, nx by M, IDs, cmtry; steady but weak (Gilster 10/22); 1405-1423 EG, nx hillites from past week, ID (Ware 11/6); 1445 EG, "Let's Learn Korean"; f (McKellar 10/19).
- 9750 ROMANIA RB; 2100-2105 EG, nx, cmtry (Krist 10/29, Hawk 10/16).
- 9755 CANADA RCI; 0200 EG, IS, ID, Ian McFarland DX (Stanley-AZ 10/16).
- 9760 MOROCCO VOA; 2108 EG, nx, "New Horizons" (Hawk 10/16).
- 9765 GERMANY W. DW; 2123 EG, cmtry, German by radio (Hawk 10/16).
- 9765 USSR RM; 0116-0131 EG, cmtry, nx (Hawk 10/20).
- 9780 YEMEN R. Sana'a; *0300 AR, ID, NA, into Qur'an (Stephany 10/29).
- 9790 FRANCE? RFI; 2010 FR, v. strong and presumed Moyabi relay, folk rock, unexplained hum (Pickard-IL 11/9). Not sure Gabon, Wilder-ed. *2200 FR, IS, ID's, into nx; //11955, 11995 (Ware 11/6).
- 9795 USSR RM; 2235 RS, tlk by W, mx, ID (as what? -ed) (Plotnick 10/31).
- 9805 EGYPT RC; 2130 EG, nx of M.E., cmtry; g (Alcorn 10/29); 2230 EG, Egyptian music (Weinhold 10/13).
- 9815 ISRAEL KI; 2000-0200 EG etc. (6 reporters).
- 9820 CHINA RB; 1100 EG, pgm about artificial breeding of kelp (Blanchette-FL 10/14). That's what separates the kelps from the Keltis, hi! 1230-1246 EG, "Learn to Speak Chinese", sports (Jordan, Purdue).
- 9840 KUWAIT RK; 2032-2122 AR, good M.E. mx, ID, nx (D'Angelo 10/15).
- 9850 EGYPT RC; 2315 AR, Arabic mx, ID by M, nx at 2330 (Prath 10/20).
- 9860 CHINA RP; 0000 EG, nx, cmtry (Zilmer 11/7, Krist 10/20).
- 9865 GREECE VOG; 0130-0350 GK/EG to N.Am. (5 reporters).
- 9880 BELGIUM BRT; 0029 EG, "Brussels Calling" (Krist); 0030 "Music Box", "Radio World" (McLemore-FL 10/17); 0030-0100 EG, ID, "Focus on Belgium" (Dillon-PA 11/3); 0044-0115 EG, "P.O. Box 26" program, music, ID, etc. (Giacopelli 11/15).
- 9895 HOLLAND RN; 2305 PT, DX pgm ment. R. Norway, RCI (Prath 10/20).
- 9977 KOREA N. RP; 1600-1605 EG, nx; g (McKellar 10/16).
- 9915 UK BBC; 2130-2200 EG, "Calling The Falk. Is." (Jordan 10/25). W.S.; 0000-0020, ID, world nx etc. (Trotto-FL 10/23).
- 9977 KOREA N. RP; 1211 EG, commentary (Purdue 10/10).
- 10010p VIETNAM VOV; 1135-1145 CH, oriental instrumentals (Jordan 10/19).
- 10040 VIETNAM VOV; 1150-1159 RS, heroic baritone solo (Jordan 10/19). 1906 EG, ID at 1907, tlk about China & USA (DiBlase 11/2).
- 10060 VIETNAM VOV; 1145-1215+ VT, high-pitched W (Jordan 10/19).
- 10335 INDIA AIR; *1300 Sinhalese; heard IS, s/on by M (Prath 10/16).
- 10680 ARGENTINA R. Rivadavia relay; 2230-2327 SP soccer game, ads presented on the hour, full ID, "630 khz."; f (Holland 10/21).SSB?
- 11615 ISRAEL KI; 1100 EG, nx, wx, not listed 11610 (Zilmer 11/7).
- 11620 BELGIUM BRT; 0030-0115 EG to N.Am. (Stanley 10/14, Trotto 10/14).
- 11620 INDIA AIR; 1845 EG, Indian mx, W ancr w/small talk between records (Hewitt-MI 11/6); 3135 EG, subcontinental mx, features, W ancr; f (Summers-PA 11/4); 2200 EG, ID & nx by W (Jones-TX 10/22).
- 11645 GREECE VOG; *1500 GK, s/on anmts (Walcutt 11/20).
- 11650 CHINA RB; 0000 EG, nx, cmnt; f (Zilmer 11/1); 0020 EG, pgm "Third World Marches ON" (Alcorn 11/3); 0030 EG, nice Chinese folk music; good (Cassidy 11/6).
- 11655 ISRAEL KI; 2230 EG, IS, ID, nx bulletin, travel pgm "This Land" (Stanley-AZ 10/11); 0000-0030 EG, nx, "Spectrum", g (Dillon-PA 10/25); 0230 SP, time pips, "Shalom & Buenos Noches"; xmsn sked; W ancr w/news; v. good (Choroszy-ME 10/17).
- 11655 MONACO TWR; *1505 EG, ID into RS religion; unjammed (Wood 10/20).
- 11665 AUSTRIA ORF; 2130-2200 EG, nx of Austria (Weinhold 10/5); 2150 EG lbx pgm, into FR at 2200 (Jones-TX 10/9); 2155 EG (Purdue 10/25).
- 11670 PAKISTAN RP; 1703 EG, "You are listening to the news in the World Service of Radio Pakistan"; //15505 (D'Angelo 10/29).
- 11675 KUWAIT RK; 1802 EG, IS, ID, fay, pop mx (Purdue 10/9); 1815 EG, US rock mx, nx at 1830 (Jordan 10/29); 1834 EG, M.E. nx, pop mx, "Kuwait In The Week"; g (Choroszy 10/29); 1848-1944 EG, continuous vocals to 1914, discussion abt albums; heavy hum (Bonnet-IN 10/12); 1900 EG, nx, rock pops (Krist-VA 10/22); 2035-2100 EG, W ancr, pop music review, ID at 2100, NA and off; g (Summers-PA 10/12); 1805 EG, disco-fied Beatle tunes, nx (Alcorn 10/22).
- 11695 CHINA RP; *1200 unid lang., s/on w/IS, very weak signal (Prath).



LOG REPORT

section D

11700 and above

Editor: Brett Saylor, P.O. Box 10, Whitehall, PA 18052

- 11700 DOMINICAN REPUBLIC R Clarin; *1345, 1950-2316 SP, ballads, cmtry on the current Carib events incl Grenada, IS, ID (Alcorn, Trotto, Dillon, McKellar, D'Angelo) R Earth Int'l; 0200-0305* EG, DX pgm, David Monson, discussn on new freq of 6185 (Plotnick, Bonnet, Burke, Purdue)
- 11705 nf FRANCE RFI; 0415-0430, 0445-0500 EG, 0500- FR, nx pgm, //7135, 9745 f-g, (Jordan, Burke) Purdue, Alcorn)
- 11705 SWEDEN RSI; 2300, 0230 EG, 2300 pgm replaces 11710 & is // 9695 (Zilmer, Stanley)
- 11705 MONTERRAT DW; *1155-1225 GM, IS, ID, freq's, "Carib Relay" anncd (Cobb 10/24)
- 11710 ARGENTINA RAE; 0020 SP, 0100 EG, "Report on the Malvinas", nx, sports; off 0130 into FR, //6060 (covered by Port 0030) (Desrosiers, Enkenhus, Hewitt, SWITZERLAND SRI; *0145-0215, 0430-0500 EG, "Dateline", /Ware, Stanley) //9690 QRM frm AR station on freq (Purdue, Dillon, Stanley, Trotto)
- 11720 AUSTRALIA RA; 0912-1100 EG, "Soundabout" pgm, nx 1000 (Fields 11/7)
- 11720 CANADA CBC; 1330-1345 EG, "Morningside", fair (Trotto 10/18)
- 11720 USSR R Vilinus; 2300 EG, "Mailbag" pgm, mx; g (Stanley, Krist 10/12) R Kiev; 0030-0058, 0300-0400 EG, "DX Club", mx (Jordan, Krist 10/25)
- 11720 BULGARIA R Sofia; *0900 GK, nx, Sun only, //11750; both QRMD de USSR (Wood 10/9)
- 11725 CUBA R Habana; 2100 (lang?), "Cuban Profile" pgm, f (Stanley 10/23)
- 11730 PORTUGAL R Renascenca; *2300-0030 PT, IS, ID by M, opening anncd by M, MOR mx, to Brazil; g (Mayer 10/14) 0045 PT, tent, PT mx, nx 0059, f (Cassidy)
- 11730 SOUTH AFRICA R RSA; 0200 EG, //9615, 5980, Afr nx, "Under the Southern Cross" cmtry on wld terrorism (Bonnet, Dillon, McLemore, Desrosiers)
- 11740 MADAGASCAR R Nederlands; 1855 EG, "Happy Station" pgm (Vadino 10/9)
- 11745 T TUNISIA RTT; 1950-2015 AR, mx, tent ID w/ mnt Tunis @2000; QRM de BBC (Lausevich)
- 11745 USA KGEI; 1515-1600* RS, rel tik, mx, ID (Bobb 10/27)
- 11755 TURKEY VoT; 2200 EG, "Turkish Songs & Lyrics", //9515 (Fraser) 2325 TK, mx (Purdue) 0315 EG, rwv of TK press, mx, headline nx (Trotto 10/20)
- 11765 IRAQ R Baghdad; 0900 Farsi, ID, cmtry, romantic mx, g, //9585 (Wood 10/9)
- 11780 USSR RM; 0015 EG, pgm on med svc in the USSR (Trotto 10/7)
- 11780 SEYCHELLES FEBA; *1700, IS, Somali religion, "Halkani waa R FEBA" (Wood)
- 11780 BRAZIL R Nac. da Amazonia; 2200 PT, "Voz do Brazil" pgm (Field) 0758 PT, ID, IS, "R Nac da Amazonia emissora Radiobras...", strong signal (Fields)
- 11785 USSR R Tashkent; 1225-1230* EG, ID, mx (Trotto 10/19) *1200-1228* EG, "R Tashkent Calling", nx pgm, local mx (Jordan 10-25)
- 11790 INDONESIA RRI-Voice of Indonesia; 1350-1427, "Love Ambon" IS 1350, FR ID 1356, nx in EG to FR & AR nx pgm, p (Lausevich 10-21)
- 11793 COLUMBIA R Nac.; 0115 SP, Classical mx-opera; p (Cassidy 11-6)
- 11800 ITALY RAI; *0100-0019* EG, ID, nx by YL, jazz mx (Krist 10-15, Stanley, Cassidy) 2310 IT, tk by M & W abt IT coffee (DiBiese 11-2)
- 11810 SOUTH KOREA RK; 0500 EG, ID, nx, cmtry abt gvt officials killed (Stanley 10-14)
- 11810 EAST GERMANY REI; 1833 EG, Afr nx and cmtry (Burke)
- 11815 ECUADOR HCJB; 1230-1247 EG, "Morning Sounds" into lang 1247 (Weinhold)
- 11815v LIBYA R Jamahiriyah; 2215-2341 EG, Green book, tik on US intervention in Central America, pop mx, many ID's (10 reporters) (Blanchette, Bonnet)
- 11815 NETHERLAND ANTILLES TWF; 1130-1230 EG, "Morning Sound" pgm, Bible readings
- 11825 TAHITI RT; 0310-0545 Tahitian, Polynesian mx, f (Sharpe, Stanley)
- 11830 VATICAN VR; 2220 EG, end of pgm to Australia, //9615 (Prath 10-23)
- 11830 ROMANIA R Bucharest; 0225 EG, "Radio NxReel" (1), ID (McLemore 10-26)
- 11830 USA WYFR; 1602 EG, "Unshackled" pgm (Bonnet 10-13, Fraser)
- 11835 SRI LANKA SLBC; 1035-1100 EG, jazz mx pgm, "Potluck" mx pgm, f (Cobb, Ware)
- 11840 USSR RM; 1900 EG, "Unkind Comments" on US-Grenada sit (Witte 11/2, Gaffin, 11845 VATICAN VR; 0100 EG, rel tik, pgm on Popes (Purdue/ Bonnet, Blanchette)
- 11845 CANADA RCI; 0220 EG, Glenn Hauser (Witte 10/16) Plotnick
- 11850 USA WYFR; 1340 EG, "Sounds of the New Life" (McKellar 10-27)
- 11850 BULGARIA R Sofia; 2137 EG, world nx, cmtry (Jones 10/9)
- 11855 SAUDIA ARABIA BSKSA; 175-1800 EG, ID, tik by M & W (Mayer 10-15)
- 11855 CZECHOSLOVAKIA R Prague; 0730 EG, ID, pgm hilites (Trotto 10/31)
- 11865 USA VOA; 1545 OH, ID in EG, "Yankee Doodle (Bonnet)
- 11865 BRAZIL R Clube de Pernambuco; 0754-0834 PT, tik by excited M, nice jingle.

lively instrm mx, nothing on 6015 (Valko at Cucura's QTH, Glikman)

11865 MALTA DW; 0100-0150* EG, "Microphone on Europe", g (Trotto, Stanley)

11870 NORWAY RN; 1300, 1908 EG, IS, ID, "Mqilbag".p.//15175 (Vadino, Trotto)

11880 SPAIN SFR; 0000, 0130, 0530 EG, "Panorama", nx, //9630 (9 reporters)

11890 NETH ANTILLES TWR; *2215 SP, IS, nx (Prath 10-23)

11900 SAIPAN KYOI; 1330 EG, JP, rock mx, ads, "This is Super-rock" (Fraser, Burke)

11905 BRAZIL R Universo; 0815-0829 PT, tlk by M & W, -mx, full ID w/ ment of three freq's, call letters given, tc's, jingles, vg (Valko 10/2)

11910 ECUADOR HCJB; 0530-0545 EG, "Passport" pgm, g (Mayer 10/15)

11910 HUNGARY R Budapest; 1700 EG, nx, cmtry, f (Choroszy 10-19)

11920 IVORY COAST RD Ivoriennne; 2015-2055 FR, guitar mx, ID in FR, p (Lausevich)

11925 PORTUGAL RHP; 0300 EG, NA, ID, nx headlines, vg (Mayer, Stanley, Enkenhus)

11930 CUBA AB; 0100, 0325, 0400 EG, Cuban mx pgm, nx (Stanley, Dillon, Purdue)

11938 KAMPUCHEA VOPK; 1249-1305 Laotian, caught end of what was prob the Lao pgm into start of what was prob the Viet pgm, IS, ID 1259 (Glikman 10-25)

11940 USA WRNO; 2330 EG, Hauser's "World of Radio" pgm (Fraser)

11940 GABON Afr #1; 1910 FR, fast tlk DJ w/ mx (Jones)

11945 CHINA RB; 0142 EG, story, ID, freq & pgm sked (Purdue)

11950 JAPAN RJ; 0910 JP, ID, tlk by W, IS, weak (Trotto)

11950 USA WRNO; 2200 EG, rock mx, commercials (Mayer, Gaffin, Purdue)

11955 LEBANON RL; 0230 EG, nx abt explosions that killed US Marines stationed in that country, expressing sorrow at the incident (6 reporters)

11955 PHILIPPINES R Veritas Asia; 1430 EG, "Tell ME", g (McKellar)

11960 NEW ZEALAND RNZ; 0520-1000 EG, nx, disussion pgm, rel pgm (Thunberg, Jordan)

11965 RWANDA DW; *1500 EG, wld nx, QRM de VOA (Thunberg 11-8)

11985 ALBANIA R Tirana; 1735 EG, "Albanian Calender" f (Mayer 10-22)

11990 CZECHOSLOVAKIA RP; 0100 EG, nx, mx for your tape recorder (Stanley, Purdue)

12000 HUNGARY RB; 0200, 0300 EG, nx, cmtry, pres rva (Trotto, Stanley, Jones, Bonnet)

12025 ISRAEL KI; 2015 EG, DX pgm into sports (Alcorn)

12035 SWITZERLAND SRI; 1815 EG, to Eur & Afr, nx (Alcorn 11-6)

12050 USSR RM via Petropavlovsk-Kamchatskiy; 0517 EG, Moscow Mailbag, KAL 007 again, per Legge's UHN (Sharpe 10-17)

12070 USSR R Rodina; *1400-1430+ RS, ID, taped interviews, RS folk mx (Jordan)

12070 MONGOLIA Ulan Bator; 1218-1232* EG, cmtry by W & listeners' letters (Bolland)

13797 ICELAND ISBS; 1825-1905 Icelandic, presumed nx, on USB/AM, mx (Purdue, Vadino)

14430 H CENTRAL AFRICAN REPUBLIC R Bangui; 1810 FR, DJ show w/ "Melody/Desrosiers" Makers". 2x7215, g (Wood 10-15)

15040 * SCOTLAND R Freedom Int'l; noted from 1121 on 11-6 with light rock, EG test ancmnt's. Sig poor at first, but improved until blocked by RTTY on freq at 1130. FR ID hrd thru mess at 1139. RTTY stopped at 1144, by which time this one was really holding forth quite well. Asking for reports to (published) address of Dept. R, 67 Elm Row, Edinburgh EH7 4AQ, offering QSL, requesting IRC's. Giving location as 56.12°30'N, 3.25°W, which would put them at or near a place called Kinross, abt 20 mi NW of Edinburgh. Only unusual thing was that they said their 'proper program' would begin at 0900 GMT on 11-6, with 15040 in // with 6230 and (I think) 97.5 FM, but that ancmnt was hrd at 1123. Wonder if they were on 15040 pre-0900 as well? Sig on this made me wonder if perhaps this wasn't a relay by a NA pirate, but I'm quite convinced that it was direct. Have sent report so we'll see. Went off 1151* (Berg) Exc report. Hope we will find out if the site is actually in Scotland. Pls keep us posted....bs

15050 USA KQSB Int'l, pirate; *1856-1908, carrier on, IS, ancmnt 'you are under arrest for conspiracy for listening to a pirate station', sing on by Frank Furter, rock mx. Fantastic signal for only 100 watts (Arthur, HI 10-30)

15060 SAUDI ARABIA BSKSA; 1510 AR, Keran pgm, Arab wld nx (Jones, Lausevich)

15070 UK BBC; 1724-1930 EG, "Outlook", "Nx Abt Britain" (Bobb, Mayer, Gaffin)

15084 IRAN VOIRI; 1445-1600 Farsi, -lk by M ancr, martial mx, nx (Jordan, Cassidy)

15100 CHINA RB; *1600-1755* EG, nx, QRM Moscow, RRI//15165, p (Wood 10-19)

15115 ECUADOR HCJB; 1255, 0228 EG, "DX Party Line", //17890 (Krist, Trotto, Fraser)

15115 AUSTRALIA RA; 0400 EG, "Austr Editorial Opinion", nx (Stanley)

15117.5 EGYPT R Cairo; 0930 AR, "Aida" melody ID, //15175, 15210, f (Wood 10-20)

15120 INDIA AIR; 0239 vern/EG, nx in lang, then EG ID & nx (Park 10-4) Zilmer)

15120 NIGERIA VON; 1615-2115* EG, nx, cmtry, agricultural rpt (Vadino, Jordan, Cassidy)

15120 USA UN Radio; 1945-2000* AR, ID, contest details, listener's letters (Bobb)

15140 TURKEY VOT; *0900-1000* EG, nx, //11955, g (Wood 10-20) Trotto)

15145 USA WINB; 2305-0015 EG, rel pgm (Alcorn, Krist, D'Angelo 10-15)

15150 CHINA RB; *1600 RS, greeting "Comrade listeners", nx, f (Wood 10-19)

15165 DENMARK RD; 1444-1453 * DN, tlk, mt Singapore, EG ID at s/off (Taunberg) 1730 s/on EG, DN ID, for Greenland & Pacific (Alcorn) 1814 DN, IS, covered by VOA (Vadino 10-9) *1900 DN, EG ID, DN nx, g (Wood 10-7)

15170 TAHITI RT; 0150-0400 FR, church service, mx (Stanley, Plotnick)

15175 USSR RS Atlantika; 1330 RS, interview and light mx (Fraser 10-22)

15175 NORWAY RNI; 1600 NO, ID at 1600 in EG, into nx (Summers)

15180 USSR R Yerevan; 0330-0359 Armenian, EG, ID 0330 "Yerevanne Khosum", mini-drama, poetry rdg, into EG 0353, ID, nx summary (Enkenhus 10-22)

15200 SEYCHELLES FEBA; 0426-0503 EG, "Newsbreak" pgm, w/ address of Box 4962, Nairobi for pgm BKed, then "Show Time" rel pgm (Enkenhus 10-8)

15205 GREECE VO Arelay; 0440 EG, "Closeup" pgm, g (Trotto)
15210 BELGIUM RTB; 1758 FR, IS, nx, to Afr.//17675 (Vadino 11-5)
15220 SOUTH AFRICA R RSA; 0705 EG, "DX Corner" (Park, HI 10-30)
15225 TUNISIA RTT Sfax; 1757 AR, mx, brief anmt, f (Valko 10-10) (Stanley)
15235 JAPAN RJ; 2300 EG, Asian, wld-nx, current affairs, //9645,11740,15195,17755
15240 USSR R Kiev; *0030 EG, end of RS Rodina prm, then Kiev IS, ID, into nx (Ware)
15240 EAST GERMANY RBI; *1245-1330 EG, ID, nx, of 1330 (Trotto 10/2)
15250 PORTUGAL RDP; *1900 PT, ID, to Afr.//17880, g (Wood)
15250 ROMANIA RB; 1310-1330* EG, ID, cmtry,g (Trotto)
15265 INDIA AIR; 1700 EG, tlk, horrible cracked modulation, g but unreadable(Wood)
15270 TAIWAN VOPC; 2225-2240* EG, tlk on CH architecture, mx (Thunberg)
15280 USA KGEI; 2140 EG, haven Of Rest" pgm (Burke) Bonnet,Krist,Witte)
15290 BRAZIL R Bras; 0200-0241 EG,mx, letters, special features(Plotnick,Gaffin,
15295 MALAYSIA VOM; 1600 AR, nx, f (Wood 10-4) Purdue)
15300 JAPAN RJ; *2345, 2116- 2130* EG, ID, nx, current affais (Stanley,Ware,DiBiase,
15300 UNITED ARAB EMIRATES UAE Radio; 1602 AR, mnt "Abu Dhabi",into EG 1612(Purdue)
15305 DODECANESE ISLANDS VOA relay; 1930-2000 AR, IS, pop mx, p-f (Bobb)
15310 OMAN BBC relay; 1820 EG, "NxDeak" (Vadino 10-9)
15310v GUINEA La Voix de la Revolution; 1900-0013 FR, 1824-1900 EG, cmtry of Black
oppression in S Afr, Afr vocal mx, pgm on history of Guinea (7 reporters)
15315 LIBERIA VOA relay; *1829-1833 EG/FR, EG ID into FR pgm of nx (D'Angelo)
15320 UAE 1501 AR, 1612 EG, Arab history pgm (Purdue 10-9)
15320 AUSTRALIA RA; 2300-0426 EG, world nx, pop mx, cmtry (7 reporters)
15325 SEYCHELLES FEBA; *1225 EG, nx then into SP at 1230 (Trotto)
15335 MOROCCO RTM; 1340-1405+ AR, vocal mx, radio drama (Jordan)
15345 TAIWAN VOPC;0100 EG, nx roundup, culture pgm (Stanley 10-24)
15345 USA AFRTS; 1845-1850 EG, Larry King show (Trotto,Gaffin) Cobb, Bonnet)
15345 ARGENTINA RAE; 0100 EG, tlk on Falklands/Malvinas, //11710 (Jordan,Unke,McLemore
15350 LUXEMBOURG RL; 1810 FR, new Dylan mx, feature on the Doors, ads (Choroszy)
15390 EAST GERMANY RBI; 1800 EG, nx, cmtry, sports, mx (Zilmer)
15400 FINLAND RF; 1500-1530 EG, 1530 Finnish, "Norhtern Report", nx(Bobb,Vadino)
15405 FINLAND RF; 1230 EG, s/on (Alcorn 10-30)
15405 SAIPAN KYOI; 0100 EG, rock mx (Zilmer 11-7)
15415 BRAZIL R Clube Ribeirao Preto; 0125 PT, pop mx by Kinks, p-f (McLemore,Cobb)
15420 USA WRNO; 2000-2317 EG, Saints-Bucs game, vg (McLemore 10-23)
15435 PHILIPPINES VOA; 1320 EG, interview w/ a Brazilian on wld econ (Gilster)
15450 PHILIPPINES FEBC; *2300 EG, instrm mx, nx, Bible course (Alcorn 10-27)
15474 ARGENTINE ANTARCTIC LRA36; 2243-0010 SP, light LA vocal mx, occ tlk by M
and w anncr, freq slightly below 15474; EG ID inviting listeners to write
in with reception reports. (D'Angelo, Valko, Moman, Cunningham)
15485 NEW ZEALAND RNZ; 1500 EG, ID, wld nx, p (Stanley 10-30)
15495 KUWAIT RK; 1350 AR, home svc relay w/ AR mx, //15110,17650 (Prath 10-16)
15520 CHINA RB; 0100-0156* EG, CH vocal mx, letterbox show (Gaffin,Bonnet,Cobb)
15555 CLANDESTINE R Vatan; 1750-1759* Farsi, M & W anncrs, ID 1757, g (Summers)
15560 AUSTRIA ORF; 1720 GM, IS, nx, mx (Vadino)
15575 SOUTH KOREA RK; 0045 PT, 0200 EG, nx, cmtry,mx (Trotto,Zilmer,Stanley)
15588a ISRAEL KI; 2005 EG, int'l nx about Lebanon (Purdue)
15595 MOROCCO RTM; 1315 AR, tlk by M, AR pgm of mx 1320, //17595 (Stanley 10-9, Zilmer)
15590 BELGIUM BRT; *1915 EG, "Brussels Calling" (Krist 10-22)
17595 nf MOROCCO RTM; 2000 AR, usual fanfare, nx; first time this stn noted out-of-
band, //15334.4, g (Wood 10-6, Gilster)
17565 GREECE VoG; 1540-49 EG, nx during GK pgm (Zilmer) out of order
17610 BELGIUM BRT; 1400 EG, questions on missiles (Bonnet 10-20)
17620 FRANCE RFI; 1600 EG, "PCA", Afr nx (Mayer, Stanley, Purdue)
17650 nf SPAIN REE; 1400, 1700-1800* SP, nx, //17660 (Bobb, Zilmer, Wood, Plotnick)
17675 BELGIUM RTB; 1900 FR, relay 2nd pgm of RTBF, weather rpt (Wood 10-22)
17680 CHINA RB; 0340-0345 EG, CH lang lesson, g (McKellar,Stanley,Hazeltine)
17680 BELGIUM RTB; 1330-1357* FR, tlk, mx (FR network) not BRT (Zilmer)
17700 EAST GERMANY RBI; 1520 EG, tlk abt Pershing II missiles (Prath 10-15)
17705 NEW ZEALAND RNZ; 0400 EG, nx, weather, f (Stanley 10-14)
17710 NORWAY RNT; 1400 EG, "Norway Today" pgm, //17860,15345,6015 (Zilmer)
17715 SINGAPORE BBC; 0020 EG, "Eastern Relay Stn" ID, into "EG by Radio"(Gilster)
17715 NORWAY RNI; 1400 EG, "Listener's Corner" (Prath, Fraser)
17720 ROMANIA RB; 1320 EG, "Listener's Club" (Zilmer 11-6)
17720 FRANCE RFI; 1455 FR, US R&B mx, f (McKellar 10-21)
17730 USA UN Radio; 2100-2130 EG, Afr nx (Bonnet 10-21)
17730 USA WNB; 1610-1700 EG, rel tlk by M, mx, ID, g (Bobb 10-16)
17745 SOUTH AFRICA R RSA; 2130-2200 EG, nx (Weinhold 10-5, Gilster)

17745 ALGERIA RTVA; 2001 EG, Int'l and Algerian nx (Mayer, D'Angelo, Purdue)
17755 JAPAN RJ; 2300 EG, Asian & wld nx, current topics (Alcorn, Stanley) 0300 EG
Gen Svc ID, //17810, both poor (Choroszy 10-17)

17770 AUSTRIA RA; 1230 EG, "Report from Austria", replaces 17860 to Nam (Zilmer)
17775 AUSTRIA ORP; 1850 EG, listener's letters, off 1900 (Prath 10-9)
17775 UAE UAE Radio; 0330 EG, nx headlines, financial nx, f (Stanley)
17800 RWANDA DW relay; *1225 EG, IS, ID, Afr Svc, //21600 better (Cobb 10-24)
17805 USA WYFR; 0041--131 SF, cmtry by M, prob a sermon (Bonnet 10-19)
17810 JAPAN RJ; 0100 EG, IS, ID, wld nx (Stanley 10-21)
17820 CANADA RCI; 1530-1600*, *2230-2259* EG, nx, "SWL Digest" (Krist, Trotto)
17825 JAPAN RJ; 0010 EG, current affairs, trade disc (Hewitt 11-6, Dillon, Fraser)
17830 SWITZERLAND SRI; 1320, 1530 EG, wld nx, DX pgm w/ 2 Bobs (Stanley, Fraser)
17840 PAKISTAN RP; 0230 EG, slow-speed dictation nx, p (Stanley 10-13)
17860 USSR R Vilinus; *2259-2333 RS, Mayak IS, M & W tlk, pop RS vocals, 2330 IS
and ID "Govorit Vilinus" by W. f (ENKENHUS 11-4) Trotto)

11860 AUSTRIA Austrian R; 1230-1250* EG, "Sunday Special" show (Blanchette, Krist,
17890 ECUADOR HCJB; rel pgm 1305-1330 EG, Bible study, organ mx (Bonnet)
17900 USSR R Vilinus; 2310-2330 EG, mailbag pgm, g (Dillon, Alcorn, McKellar)
17910 QATAR QBS; 1620 AR, Koran, ID (Plotnick 10-29)
19430 H CONGO R Brazzaville; 1110-1125 FR, political tlk, 2x9715 not hrd, //29145
also hrd; f (Wood 10-6)

21460 BELGIUM BRT; 1400 FR, beginning of FR pgm, pop mx (Prath 10-9)
21465 EAST GERMANY RBI; 1515 EG, nx, cmtry, g (Zilmer 11-5, Ware)
21475 FINLAND RF; 1300 EG, letters from listeners, freq to change to 15400 11-7
(Desrosiers, Krist) 1215 EG, Finnish IS, ID, f (Bobb, Blanchette)
21485 VATICAN VR; 1120 EG, rel nx to Catholics (Berryman 10-12)
21485 PAKISTAN RP; 1245 AR, tlk and mx, f //17640 (Ware)
21490 ASCENSION ISLANDS VOA; 1129-1200 SP, ID in EG, IS, nx, cmtry (Cobb)
21505 CZECHOSLOVAKIA RP; 1230 EG, nx, cmtry, mx, g (Zilmer, Ware)
21530 SAUDI ARABIA BSKSA; 1130 IN, tlk on Islam, now here as sked, ex 21465 to
avoid Cairo, //17895, g (Wood 10-20)

21540 EAST GERMANY RBI; 1330 EG, nx, cmtry, //21465 (Zilmer)
21545 BANGLADESH RB; 1700 Bangla, nx, g (Wood)
21560 ITALY RAI; 1900-1905* IT, light piano mx, ID, IS (Bobb)
21570 nf NORWAY NRK; (time?) NO, wx for ships, list freq but gave this one as "21575",
as also in sked; bad choice as mixed w/ SRI also to Afr, MEast, p (Wood)

21600 RWANDA DW; 1245-1315* EG, nx and cmtry (Trotto, Zilmer)
21620 JAPAN RJ; 0130 EG, wld nx, cmtry (Purdue, Stanley)
21615 SWEDEN RSI; 1400 EG, to Nam, replaces 17860; //15285 (Zilmer)
21615 USA WYFR; 1735 EG, "Mailbag" pgm, //15440 (Prath)
21655 UAE Dubai; 1520 AR, MEast mx, to Europe (Desrosiers)
21660 ASCENSION ISLANDS BBC; 1545-1614* EG, "Outlook" pgm, f (Bobb)
21695 ITALY RAI; 1410-1425* IT, mx, F anncr w/ freq, ID, IS, g (Summers)
21700 NORWAY NRK; 1500 NO, ID, lists 21575 but now here, ex 21570 (Wood)
21730 NORWAY RNI; 1600-1630 EG, IS, ID's, "Norway Today" (Stanley)
21802 PAKISTAN RP; *1100-1115 EG, dictation speed nx, g (Wood 10-6) Mayer)
21815 BELGIUM BRT; 1400 EG, *1235 EG, "Brussels Calling", "POB 26", nx (Zilmer, Prath,
25640 ISRAEL KI; 1127 lang, M reading (nx?), time pip 1130, then a W in FR; not
// Tel Aviv 25605 (Berryman 10-12)

25650 UK BBC; 1130 (Lang?), man reading obsequy of Ralph Richardson, g (Berryman)
25690 PORTUGAL R Liberty; 1359 RS; poss IS, ID by M (Ware)
25790 SOUTH AFRICA R RSA; 1134-1415 EG, ID's, freq's, cmtry pgms, "Under the
Southern Cross" pgm (7 reporters)

25800 USA VOA; 1730 PT, to Afr (Desrosiers)
25820 FRANCE RFI; 1505-1520 FR, //25900, tlk by two M (Trotto)
25900 FRANCE RFI; 1450-1500 FR, tlk by M anncr (Trotto)
26020 ECUADOR HCJB; 1525-1930 EG, rel tlk, g w/fades (Trotto, Cobb)
26040 USA VOA; 2050 EG, pgm on nature of Afr mx (Jones)
29145 H CONGO R Brazzaville; 1110-1125 FR, political tlk, 3x9715, //19430 hrd (Wood)

Thanks for the contributions this month.

73's

Brett

LOG FRENEX REPORTERS

Nick Pappas, 251 S. Olds Blvd., Apt. 243 Fairless Hills, PA 19030

Hello and welcome to the December '83 edition of FRENEX. As DX conditions improve, so do the number of contributors. Thanks to the following sixty-seven:

Samuel Alcorn, Morrisville, PA (DX200, ICF6500W); Brian Alexander, Mechanicsburg, PA; John T. Arthur, Pahoia, HI (R388); Jeff Berryman, Bronxville, NY (SX190mod); Marion Blanchette, Thonotosassa, FL (DX100, RF260, R600); Norman Bobb, Minneapolis, MN (R600, XCR30); Charles Bolland, Lakeworth, FL (R70, FRG7000); Arthur Bonnet, West Lafayette, IN (DX302); Lynn Burke, Newport News, VA (SPR4); Richard Cassidy, Logansport, IN (R1000, ICF2001); Paul Choroszy, Saco, ME (FRG7000); Ken Cobb, Portland, ME (RF4900, RF2800); Larry Cunningham, Columbus, OH; Richard D'Angelo, Wyomissing, PA; Robert Desrosiers, Fall River, MA; Pasquale DiBiase, Portland, ME (R70); John Dillaman, Centerville, OH (R70); Peter Dillon, Philadelphia, PA (3000-1); Kurt Enkenhus, Silver Spring, MD (NRD 515); Marlin Field, Hillsdale, MI (SPR4, SX100); John Fisher, Chelmsford, MA (GPR-90); Bob Fraser, Cohasset, MA (XCR30); Josh GaFFIN, New York, NY (RF3100); Tom Gavaras, Plymouth, MN (HQ180); Paul Gilster, Raleigh, NC (R70, ICF2001); Sholom Gliksman, Chicago, IL (R4C); Jim Gorichanaz, Greenfield, WI (DX302, R1000); Michael Hawk, Hampton, VA (XCR30, World Monitor II); Al Hewitt, Kingston, MI (DX300); Hans Johnson, Kingswood, TX (FRG7000, RF2200); Brian Jones, Houston, TX (DX302); Rufus Jordan, Pittsburgh, PA (DX302, Zenith Transoceanic); Kraig Krist, Falls Church, VA (FRG7700); Terry Krueger, Casselberry, FL (R70, ICF2001, RF4900, RF2900); Arnold Lausevich, Milwaukee, WI (HQ180C, RF4800); Jerry Lineback, Conroe, TX (R7); Bill Mayer, Allentown, PA (DX200, TCS12); Tom Mazeltine, Seattle, WA (FRG7, ICF5900W); John McKeller, Pullman, WA (DX160); Travis McLemore, Clearwater, FL (FRG7); Don Moore, Santa Barbara, Honduras (FRG7mod, ICF7600A); Ray Niekamp, Minneapolis, MN (DX200); Joe O'Brien, Bronx, NY (ICF2001); Dale Park, Honolulu, HI (ICF6700W); Sheryl Paszkiewicz, Manitowoc, WI (DX302); Wilder Pickard, Evanston, IL (R7, XCR30); John Pirnat, Denver, CO (SX110); Alan Plotnick, Hamden, CT (R7); John Prath, Ft. Lauderdale, FL (FRG7000, FRG7, RF4900, DX160); Ronald Purdue, Byron, MN (DX300); Christos Rigas, Chicago, IL (R2000); Mark Schlesinger, Clute, TX (FRG7700); Roland Schulze, Stuttgart, FRGermany (R70mod, R7000mod, R6C); Bryan Sharpe, Castro Valley, CA (DX302); Trevor Stanley, Flagstaff, AZ (NRD515); Nolan Stephany, Williamson, NY (R392); Steve Summers, Mechanicsburg, PA; Bob Thunberg, DuBois, PA (SSR1, HQ200); Ron Trotto, St. Cloud, FL (DX100); George Vadino, Bellevue, WA (RF4800, SX110); Dave Valko, Dunlo, PA (DX160, FRG7, R388); Lauren Ware, Fairfax, WA (FRG7700); Terry Weinhold, East Earl, PA (R1000); Marjorie Witte, Torrance, CA (FRG7); Eric Witzig, Annandale, VA ((R1000); Richard E. Wood, Abha, Saudi Arabia (R7, R1000); Robert Zilmer, Rio Rancho, NM (R1000, ICF5900W).

Best wishes to you and yours this holiday season. Don't forget, the deadline for the upcoming issue is the twelfth.

73's and good DX,

Nick
—

HAP DIRECT SALE ITEMS: The following stickers/decals are available for \$.25 each or any 5 for \$1.00 (Please - minimum order of at least \$3.00): WEMP, Disco-99, European Music Radio, Amateur Radio, WBWA, KPLU, Radio Reporter, WXQR, WJNC, WBIW, Radio Tees, KWK, Radio Canada International, Radio France International (large) (red) (blue) (circular), Radio Vatican (semi-cir.) (square) (small), KMJK, WMAL, Radio Sweden International (large) (circular), WCBW, KCFM, ANARC, CKGB, CFTI, Radio Moscow, Radio Berlin International, Radio Nacional de Espana (soccor) (cir.) WDR Radio (rock) (small), Radio 270, WQMR, KFQG, 55-Country, WMET, 6WR, Radio Derby, Rete Quattro, KHAM, Polskie Radio (green) (blue) (gray) (orange), Radio Budapest, BDXC, ORF, 6KY, 12B, Metro Radio, WCLB, KBDF, KBOI, KPNW, KOME, WQMF, KDKD, WCFL, KTXQ, WEZY, WLRS, WEEI, WZZO, KROY, WLUP, KLOS, KWIP, KLOI, WINS, WDET, WPLJ, WLLZ, WWCQ and ESPN.

HAP BID ITEMS: ITEM #86: Radio Canada International QSL card "Globe and Microphone"m/c(4x6)
#87: RCI QSL card "Satellite"m/c(4x6). #88: RCI QSL card "35th Anniversary"m/c(4x6). #89: RCI QSL card "RCI Logo"m/c(4x6). #90: RCI QSL card "McLuhan"m/c(4x6). #91: RCI QSL card "1974 Cycling"m/c(4x6). #92: RCI QSL card "IYDP"m/c(4x6). #93: RCI QSL card "HAP"m/c(4x6). #94: RCI QSL card "1973 DX Year"m/c(5x7). #95: RCI QSL card "LA Service Photo" B&W(4x5.5). #96: BBC Radio City (UK) decal (4x6) red, B&W. #97: Manx Radio (Isle of Man) sticker (3"cir) red, B&W. #98: VOCM (Newfoundland) sticker (3x12") m/c - nice. #99: WFIL sticker (4x6") gold, black. #100: KTZO-TV iron on patch, m/c (2x3"). #101: Radio Korea sticker (3.5x5") m/c - beautiful. #102: Radio Tees (UK) decal (2x18") m/c. #103: Radio Luna (Italy) decal (2x18") m/c - nice. #104: WDR Radio (Germany) station pen, blue, B&W. #105: 2CH (Australia) key chain, m/c. #106: CBQ metal badge (2"cir) m/c. #107: WPLR key chain, red, white. #108: AGG (Australia) metal badge (2"cir) red, white. #109: Metro Radio (UK) metal badge (2"cir) m/c - nice. #110: BRMB Radio (UK) metal badge (1.5x2.5") m/c. #111: BBC-World Service (UK) metal badge (1.5"cir) red, white, blue. #112: Polskie Radio (Poland) station pen, m/c. #113: Radio Musichallcity (Italy) sticker (1x9") m/c. #114: 3KZ (Australia) "Heart" sticker (4"cir) m/c - beautiful. #115: Radio Mi Amigo sticker (2.5x5") m/c. #116: Radio Scotland sticker (3x12") blue, white. #117: 4XO (New Zealand) "Switch" sticker (3x7.5") m/c. #118: Radio Atlantida (Peru) key chain, m/c - very beautiful. #119: Radio Lancashire (UK) key chain, red, B&W - nice. #120: Radio Forth (Scotland) key chain, B&W, orange. #121: Radio Peking (China) pin (cir) B&W. #122: Radio Peking pin (cir) dark blue. #123: Radio Peking pin, red, white, blue. #124: Radio Peking pin, gold, B&W. #125: Radio Peking pin (square) blue, white. #126: Radio Medway (UK) pen, blue - nice. #127: WBIW/WBIF pen, red, white, blue. #128: WPX station pen, B&W. #129: Radio Medway (UK) station pen, black, yellow, blue. #130: RTE Radio 2 (Ireland) pencil, red, black. #131: Radio Tees (UK) metal badge (1.5"cir), red, B&W. #132: WEZZN metal badge (1"cir) red, white. #133: Radio Forth metal badge (1.5"cir) B&W, orange. #134: Radio Bucharest (Romania) pin (1"cir) m/c - nice. #135: Radio Berlin International (DDR) large plastic badge (2"x2") m/c. #136: Trans World Radio sticker (3x6") blue, white. #137: Radio Milano (Italy) prismatic sticker (3x8") m/c - beautiful. #138: Devon County Radio (UK) decal (3x9") m/c. #139: Radio Citta Di Corsico (Italy) sticker (3x8") red, white. #140: Swansea Sound (Wales) decal (4"cir) m/c - nice. #141: BRMB Radio sticker (5"cir) red, B&W. #142: Radio Time (Italy) sticker (2x6.5") red, white. #143: Radio Korea paper pennant (double sided w/ 2 different designs) - very nice. #144: Radio Gemini (UK) sticker (3.5"cir) m/c. #145: Radio Vatican First Day Cover w/ postage stamp (4x7") m/c - collectors item. #146: ORF (Austria) sticker in Spanish (4.5x 5.5") red, B&W. #147: Radio Forth coaster (3.5x3.5") orange, B&W. #148: Radio Monte Carlo (Monaco) sticker (2.5x6") red, white. #149: Radio Bristol (UK) cloth arm patch (2.5"cir) red, white. #150: Radio Tees decal (3x11") m/c - nice. #151: WKBR "Rainbow" decal (4x9") m/c. #152: WZZO metal license plate (6x12") m/c. #153: Devon County Radio decal (3x4.5") m/c. #154: Radio Orkney (Orkney Island) sticker (3.5"cir) red, white. #155: Radio Shetland (Shetland Island) sticker (3.5"cir) green, white. #156: Cleveland Area Cable TV cloth arm patch (2.5"cir) blue, white. #157: Radio Five (South Africa) sticker (2.5x3") m/c - rare. #158: Radio Orwell (UK) decal (2.5x15") m/c - beautiful. #159: CBC Southwest Ontario plastic litter bag (7x10") gold, white. #160: WPEZ paper hat, blue, white. #161: KIVI-TV plastic litter bag (9x12") m/c. #162: KBOI paper hat, m/c - nice. #163: WBIS metal badge (1.5"cir) red, white, blue. #164: ESPN metal badge (1.5"cir) red, white. #165: ANARC metal badge (1.5"cir) B&W. #166: KTXQ metal badge (1.5"cir) m/c. #167: KHJ metal badge (1.5"cir) blue, white. #168: ARRL metal badge (1"cir) black, yellow... Hope there is something for you... Sam.

ADDRESS: Send your bids and direct sale purchases to Sam Barto, 47 Prospect Place, Bristol, CT. 06010 USA.

ADDITIONAL DIRECT SALE ITEMS: The following stickers and decals are available for \$.50 each: WERE, Deutsche Welle (green) (blue), 2CH, BBC Radio One, Radio Peking (black) (blue) (green), Radio El Mundo, Radio Nederland, KTTS, KGBX, BRT, 4MR, ANARC (large), Radio Vatican sticker type pennant, WDR-TV, RTE Radio 2, Radio Rumba, CKCR, Radio London-266, Radio Aven, 2YE, Radio Rhema, GDXC, Radio Waikato, Canales TV, Radio City-299 and Radio Caroline (white) (black).
The following items are for sale at the quoted prices: WLPX, WMMR and WMET metal badges at \$.25 each; mini-posters from Radio London, Radio Nord, Voice of Syncom, Radio West, Radio Caroline, Radio Fil Rose, Radio Duomo (car) (woman) are \$.25 each; RBL book marks at \$.25 each; RCI QSL cards from (Council) and (Broadcasting Year) at \$.25 each; RCI DJ photos from (Gadman) (Irethewey) and (Harding) at \$.50 each; WMMR book covers at \$.25 each - or five (5) for \$1.00; metal "Antenna" badge at \$.25 each; while they last RCI pennants at \$1.50 each; 5UV poster at \$.50; WWWE plastic litter bag at \$.50 each.

HAP THANKS: A big thank you goes out to the following individuals for donating items to HAP. I. Pascal, D. Monferini, D. McCants, T. McLemore, B. Matthews, E. Southwell, J. Bruckner, J. Kapinos, and B. Campbell. Many of the items we offer can only be done with donations from people such as these. Thank you very much... Sam.

NASWA "UNITY AND FRIENDSHIP"

PUBLISHES FRENDEX MONTHLY

NASWA MEMBERSHIP FEES

First Class North America.....	\$16
Overseas, Surface Mail.....	\$16
Airmail to Central America, Caribbean, South America, Europe.....	\$25
Airmail to Asia, Africa, Pacific.....	\$28

All remittances must be in U.S. funds and mailed to: NASWA, P.O. Box 13
Liberty, IN., 47353, U.S.A.

Update: Besides FRENDEX, NASWA also publishes UPDATE..... a mid month
newsletter with the very latest DX news while it's still news. (UPDATE also
appears in each issue of FRENDEX). It is only available to NASWA members.

"UPDATE" SUBSCRIPTION RATES PER YEAR

North America (First Class).....	\$4.00
Overseas (Airmail).....	\$6.00

Sample copies of FRENDEX and UPDATE are available for \$1.00 in N.A.

Overseas.....	\$2.00
---------------	--------

EXECUTIVE DIRECTOR & PUBLISHER - Bill Oliver, 45 Wildflower Road,
Levittown, PA 19057

BUSINESS MANAGER & TREASURER - Mac Leonhardt, P.O. Box 13, Liberty, IN 47353

SHORTWAVE CENTER - John C. Herkimer, 3233 East Ave., Caledonia, NY 14423

LISTENERS' NOTEBOOK - Glenn Hauser, Box 6287, Knoxville, TN 37914-0287

QSL REPORT - Sam Barto, 47 Prospect Place, Bristol, CT. 06010

UPDATE EDITOR - Tom Alleman 636 E. 74th Terrace, Kansas City, MO. 64131

DISTRIBUTING EDITOR - Nick Pappas, 251 S. Olds Blvd., Apt. 243, Fairless Hills, PA 19030

LOG REPORT (A) - Mike Nikolich, 2137 W. Farwell Ave., Chicago, IL. 60645

LOG REPORT (B) - Jerry Berg, 38 Eastern Avenue, Lexington, MA 02173

LOG REPORT (C) - David L. Walcutt, 211 West 56th, Apt. 36-F, New York, NY 10019

LOG REPORT (D) - Brett Saylor, P.O. Box 10, Whitehall, PA 18052

SCOREBOARD - Jerry Lineback, 115 Wroxton, Conroe, TX 77304

AWARDS CHAIRMAN - Dan Henderson, 7921 Anfred Drive, Laurel, MD 20810

COUNTRY LIST CHAIRMAN - Don Jensen, 5204 70th St., Kenosha, WI 53140

U.K. REPRESENTATIVE - Alan Thompson, 16 Ena Ave., Neath, W. Glamorgan,
Great Britain, SA 113AD

FIRST CLASS MAIL

NORTH AMERICAN SHORTWAVE ASSOCIATION

45 Wildflower Road

Levittown, Pennsylvania 19057

FIRST-CLASS MAIL

U.S. POSTAGE

PAID

Levittown, Pa.

Permit No. 319