

# FRIENDX

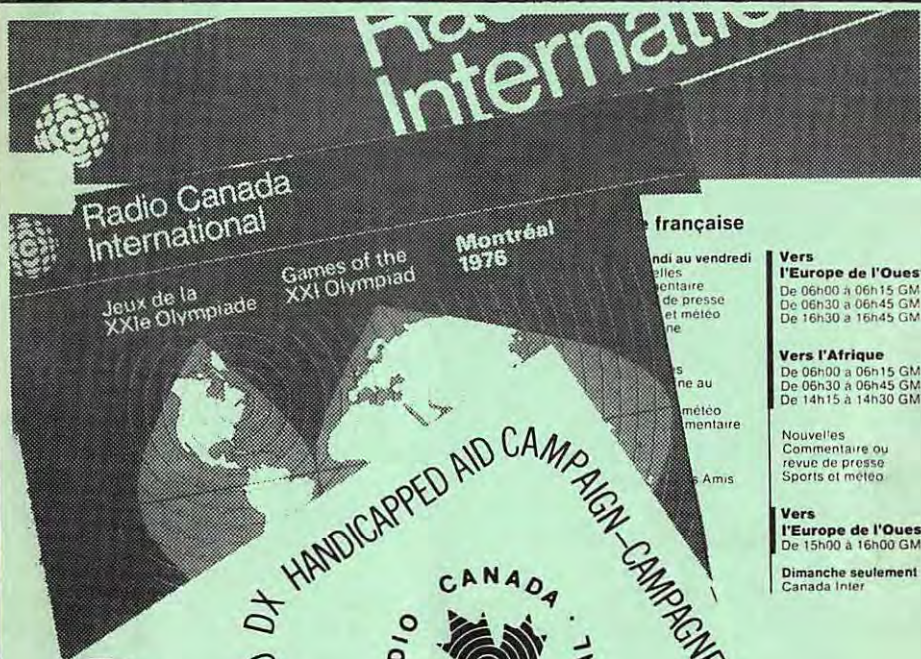

Extend the spirit of '73 support the WDX-HAC  
 Encore l'esprit de '73, appuyez la campagne

PO-P

Ежедневно (московскому)

6 15 - 6 45  
 17 30 - 18 00  
 19 00 - 19 30  
 19 45 - 20 00\*

От понедельника до субботы :

\* Последние известия  
 \* Комментарий, обзоры прессы  
 Статьи и репортажи о канадской жизни

По воскресеньям :

Последние известия  
 Комментарий или Обзор прессы  
 Воскресная программа  
 Филателия



В

Сп

СЕР.  
 Люди  
 Наука

ЧЕТВЕР  
 Канада та

ПЯТНИЦА



française

ndi au vendredi  
 elles  
 mentaire  
 de presse  
 et météo  
 ne

s  
 ne au  
 météo  
 mentaire

Amis

**Vers l'Europe de l'Ouest**  
 De 06h00 à 06h15 GM  
 De 06h30 à 06h45 GM  
 De 16h30 à 16h45 GM

**Vers l'Afrique**  
 De 06h00 à 06h15 GM  
 De 06h30 à 06h45 GM  
 De 14h15 à 14h30 GM

Nouvelles  
 Commentaire ou  
 revue de presse  
 Sports et météo

**Vers l'Europe de l'Ouest**  
 De 15h00 à 16h00 GM\*

Dimanche seulement  
 Canada Inter

Péntek  
 hírek, hírmagyarázat,  
 képek Kanada  
 életéből.

Great Britain SA11-3AD



Welcome to 60 new members joining during February.  
We hope they find their membership to be helpful.

- |   |  |
|---|--|
| AKERMAN, Richard S., Jr., Rochester, NH | KRAMER, Victor T., Sinking Springs, PA |
| ANDERSON, Jon A., Leesburg, FL          | LEVIN, Sid, Philadelphia, PA           |
| ASAKAWA, George, Yellow Springs, OH     | LOTHIAN, George G., Reidsville, NC     |
| BLANKHERTZ, Philip A., Wayne, MI **     | McWILLIAMS, Casey, W. Bloomfield, MI   |
| BURNAM, Don, Waterloo, IA               | MAHARG, James, Oak Park, IL            |
| CARLSON, Gary, Sterling Hgts., MI **    | MAXFIELD, David K., Ann Arbor, MI      |
| CHAPMAN, Howard D., Chicago, IL         | NADAV, Amnon, New York, NY             |
| CHASE, John R., St. Petersburg, FL      | NIEMAN, Jeff, Temperance, MI           |
| CHRUSCIEL, Steve, Elgin, IL             | PHELPS, David E., San Francisco, CA    |
| CINTRON, Jose A., Bayamon, PR           | PRIMM, Alex T., St. Louis, MO **       |
| CRAWFORD, Bruce D., Wilmington, DE      | RIDDLE, John W., St. Paul, MN          |
| GUEVA, Ricardo, Monterrey, Mexico       | RIPPEL, Chas. R., Virginia Beach, VA** |
| DE MAURO, Pete, Elkhart, IN             | RUST, Gene, Dallas, TX                 |
| DUBRICK, Anton J., Peoria, IL **        | RYAN, Thomas F., Chugiak, Alaska       |
| FARRELL, Edwin, Gardiner, ME            | SCHOOOF, Charles V., Greensboro, NC    |
| FITZGERALD, Robert, Bexley, Australia   | SCHWEIKART, David, Fairfax, VA         |
| FLETCHER, James, Ft. Lauderdale, FL     | SCOTT, Curtis D., Brandon, FL          |
| FRITZ, H.A.L., Hockessin, DE            | SEARS, Ken, Lompoc, CA                 |
| GEORGE, Kenneth L., St. Louis, MO       | SHIBLA, Victor, Howell, NJ             |
| GOETHE, Mack, Tampa, FL                 | SOCOL, Jeffrey, Flushing, NY           |
| GOORLEY, John P., Wheaton, MD           | STARK, Ernie, Beatrice, NE             |
| GRANT, Edward, Brooklyn, NY             | THOMKA, Gustave S., Kenosha, WI        |
| HASELL, Gerald, Hudson, NH              | THOMPSON, Larry, New York, NY          |
| HAVERLAH, Jeff, Humble, TX              | VOIGT, Herman P., St. Louis, MO        |
| HAWK, Michael, Hampton, VA              | VRUGGINK, David, Hudsonville, MI       |
| HUMPHREY, Stanley M., Bloomfield, MI    | WENTZELL, Robert L., Moorhead, MN      |
| JOSEPH, William, Waterville, ME         | WHITE, Douglas D., Chicago, IL         |
| KANTOR, Leonard, Rockaway, NJ           | WISE, Robert, Springfield, MO          |
| KELLY, Terry, Rohnert Park, CA          | WURTZEL, David C., Manhattan Beach, CA |
| KENNEDY, Clement, Pompano Beach, FL     |  |
| KILJAN, John P., Arvada, CA             |  |

\*\* Nice to have you back as a member.

\*\*\*\*\*  
DX LIMERICKS

Shed tears for Gregori Zhiveria, Technician for Radio Latveria By error one day, He plugged in VOA, Now he's earning his salt in Siberia.	DXer Joe was quite disgusted, To find his receiver was busted, Because all he could get Was an awful lot of het, So he turned it off and cussed it.
---	---

If you have a favorite DX limerick, send it to HQ today!

\*\*\*\*\*

# NASWA

A REPORT FROM  
HEADQUARTERS

NORTH AMERICAN SHORT WAVE ASSOCIATION    POST OFFICE BOX 13    LIBERTY, INDIANA 47353 U.S.A.  
MARCH, 1978

RADIO FRANCE INTERNATIONAL CLUB OF THE U.S.A.? NASWA member Matthew Brown, who is majoring in broadcast communications at Marquette University, would like to organize a RFI Listener's Club of the United States. He points out that RFI's only English program is beamed to Africa and at a time of day when few in this part of the world would find it convenient to try to hear it. He says he has been in touch with Radio France International about a transmission to North America, and if sufficient interest could be generated, they would consider further the possibility of a late afternoon or evening program for this part of the world.

Those interested in taking an active part in this should contact Matthew at 3310 Picardy Court, Mequon, WI 53092, and enclose a stamp for return postage.

DON'T YOU BELIEVE: Through last month's Listener's Notebook section one member complained that NASWA's membership list was secret and membership information was being kept from the general membership.

In the fall of 1976, NASWA did publish a complete membership directory which involved some twenty eight pages and was current as of July 1, 1976. This was offered to the membership at a very modest cost to help off set printing and mailing costs. Only a very small percentage of the membership ordered this directory, so it turned out to be an awful lot of work for so few who apparently were interested in this sort of information.

HQ has always provided upon request, the complete address of any member that another member might want to get in touch with, and we will continue to do this. There are times when we get requests for a list of names and addresses for all NASWA members in a specific geographical area. These requests we cannot fill because our records are alphabetically and time does not permit us to compile specialized listings of this sort.

VOLUNTEER NEEDED: NASWA member Bob Zilmer who is serving on ANARC's Frequency Recommendation Committee reports that he would like one more volunteer for the mid west group of this important committee. His/her location must be from the area west of the Mississippi river to the Rockies and south of St. Louis, MO. To learn more about what the duties consist of and other information, contact Robert R. Zilmer, P.O. Box 697, Milwaukee, WI 53201

HELPING HAND ITEMS: It has been some time since we explained about HH items that appear in FRENEX. For the benefit of our more recent members we will explain again.

Helping Hand items are free to all NASWA members for their use in advertising items they wish to sell, buy, trade, etc. HH items should be limited to not more than four lines, and must have to do with items related directly to the hobby, no CB's, hi fi equipment and the like. Make sure the offer states price and who pays shipping in the case of for sale items.

HH items may be sent either to HQ or to the Publisher, and they will be included in the earliest issue of FRENEX where space is available.

LOCAL GROUPS NOTE: If your local group is planning an affair that might be of general interest to the membership, feel free to send advance information to HQ, and we will be glad to announce it, space permitting, in the following issue of FRENEX.

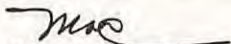
  
M.R. Leonhardt  
Executive Director - NASWA

# shortwave CENTER

JERRY A. LINEBACK, EDITOR  
P. O. Box 325  
St. Joseph, IL 61873

MARCH 1978

Welcome to Spring (I hope) and a new month of DX news, information, and tips. This may be a DX season lots of folks would like to forget, on the otherhand, perhaps you have had more time to DX while marooned in the various blizzards, floods, etc. Hope you all have portables and lots of batteries for DXing when the power goes off.

If it looks as if there is a dearth of prepared articles for SWC this month, that is because not enough have been contributed. We need your prepared articles on shortwave subjects for SWC. Without your support, we will have very little to present. What I need most are carefully written articles that I can simply retype into SWC format without extensive editing. Be an author. Start preparing your contributions today. Suggested topics: How to get the most out of your DXing time, Receiver reviews for receivers not reported in SWC in recent months, Features on shortwave broadcast stations, DX experiences, Frequency counters, Other accessories, Antennas, Aids in QSLing, In fact any subject related to shortwave broadcast radio. How about some good articles for/from beginning DXers.

If I may be permitted some space for personal use, I would like to introduce Daniel John Lineback, our third harmonic, who arrived on 3 February 1978 at 2006 GMT. His arrival was fortunate in that it was between blizzards. Just the week before, I was trapped in town, unable to get home for two days, while my wife was home feeling twinges. Dan joins brothers Nathan and Ben in keeping the Lineback household in an uproar.

\*\*\*\*\*

## THOSE NEW PANASONIC RECEIVERS

Material supplied by David Duke and  
Regino Rincon

## New Receivers

The Japanese firm of Matsushita, of which Panasonic is the U.S. sales company, plans to introduce two new portable radio receivers into the U.S. in 1978. Both feature LED digital frequency readout on shortwave bands. These receivers, the RF-2800 and the RJX-4800, join the popular RF-2200 on the American shortwave market.

We illustrate some advertising material from Panasonic here, but note that the U.S. import models may vary from the Japanese domestic versions or versions sold in other countries. In fact David Duke has had conversations and correspondence with Matsushita representatives about band coverage on the U.S. versions. It shows that Matsushita is mass market minded and has not previously considered what the needs of the serious SWL might be, or for that matter, that there are people who DX on long wave and medium wave bands also in the U.S.

The following was prepared by David Duke from conversations with Matsushita representatives. There are two distinct export models of the RF-2800 receiver, one intended for Europe and the other for North America and probably Australia/New Zealand. The domestic model has 3 SW bands covering 3.2 to 30.0 MHz, the MW broadcast band plus the Japanese 76-90 MHz FM band. The European model will have the same MW and SW coverage plus a LW band and the FM band will be 88-108 MHz. The North American model will not (apparently) have the LW band.

The digital readout on the domestic RF-2800 is capable of displaying MW frequencies also, but the MW IF of 455 kHz must be subtracted from the displayed frequency to get the correct MW frequency. On shortwave, the readout is exact (to the nearest kHz). However, the switch on the back of the receiver which allows the counter to work with the MW circuitry was deleted from the NA export model. Thus the counter is capable of working only on the SW bands. When the representative was asked why the switch was deleted, he replied that it was felt that this capability was not needed in the receivers intended for NA. Mr. Duke suggested that this might conceivably lessen the value of the receiver to the serious listener, especially for the MW listener who would certainly consider the feature to be of value when hunting for splits. He also pointed out to the Matsushita representative that there are two clubs in NA devoted exclusively to MW DXing

as well as others which cover both MW and SW. There is even a club devoted to LW listening. The Matsushita representative then indicated that they would like to hear about the needs of U.S. users of their products and suggested that Mr. Duke provide them with some input from listeners in the U.S. Mr. Duke has prepared a survey that he suggests NASWA members, interested in having products of the future more closely meet their needs, respond to. He will make the results available to Panasonic, Sony, Drake, and all other major manufacturers of shortwave equipment. Mr. Duke is not being paid by any of these companies to do this, so I have included Mr. Duke's survey in this month's SWC, after the material on the new receivers.

## RF-2800/©

## FM-AM-SW 5 BANDS RECEIVER

The Panasonic RF-2800 is a double conversion superheterodyne receiver featuring LED digital frequency display for the shortwave bands to 1 MHz. It should be available by March 1978 and will list for about \$250. Discount prices should be available as they are for the RF-2200.

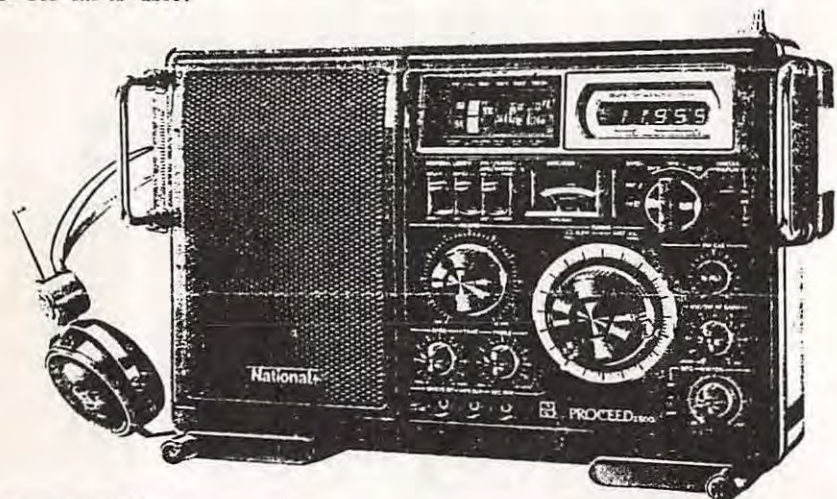

### ■ SPECIFICATIONS

<b>Frequency Range:</b>	FM 88~108 MHz AM 525~1605 kHz SW 3.2~8 MHz SW 8~16 MHz SW 16~30 MHz	<b>Power Consumption:</b>	7 W at 120V (AC Only)
<b>Intermediate Frequency:</b>	FM 10.7 MHz AM & SW 2nd 455 kHz SW 1st 2 MHz	<b>Speaker:</b>	4" (10 cm) PM Dynamic Speaker
<b>Sensitivity:</b>	FM 0.5µV (S/N 6 dB) AM SW	<b>Dimensions:</b>	15" (Wide) x 9 1/4" (High) x 4 1/2" (Deep) (381 x 246 x 120) mm
<b>Power Source:</b>	AC 120 V 60 Hz 9V (Six "D" Size Flashlight Batteries) (Panasonic UM-1 or equiv)	<b>Weight:</b>	8 lb. 10 oz. (3.9 kg) with batteries
		<b>Impedance:</b>	Speaker.....8Ω Earphone Jack .....3.2~8Ω MPX Out Jack .....10kΩ FM EXT Antenna .....75Ω REC Out Jack.....6kΩ
			<b>Selectivity:</b>
			Wide ± 2.5 kHz (-6 dB) + 15 kHz (-60 dB)
			Narrow ± 1.7 kHz (-6 dB) + 9 kHz (-60 dB)

Weights and dimensions shown are approximate.  
(Les poids et dimensions mentionnés sont approximatifs.)  
Specifications are subject to change without notice for further improvement.

# Panasonic.

Panasonic Company  
Division of Matsushita Electric  
Corporation of America  
One Panasonic Way, Secaucus, N.J. 07094

Matsushita Electric of Hawaii, Inc.  
320 Waiakamoa Road, Honolulu, Hawaii 96817

Matsushita Electric of Canada Ltd.  
40 Paterson Drive, Rexdale, Ont. M9W 1B5

ALIGNMENT POINTS

BLOCK DIAGRAM

Fig. 15

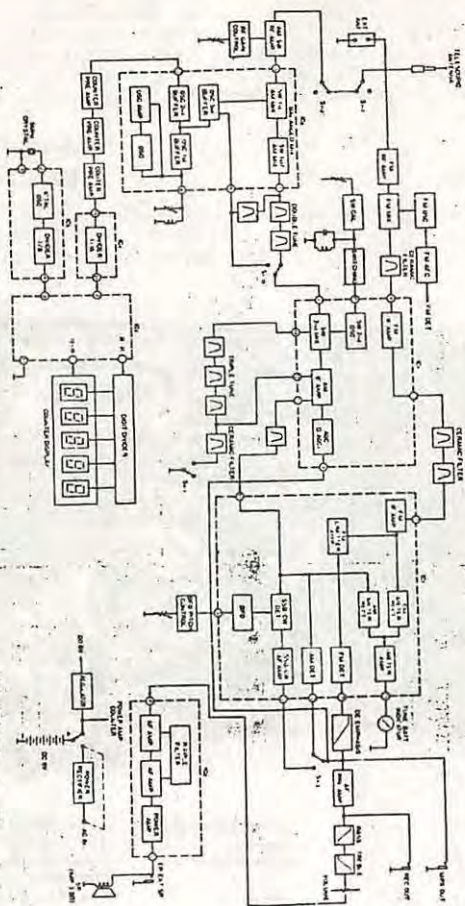

RF-2800/c

# RF-4800

A 10-BAND COMMUNICATIONS RECEIVER  
BY PANASONIC

The RF-4800 is a communications receiver with complete coverage from 525 kHz to 31 MHz. The FM band is also provided. It is a double conversion synthesized receiver using the phase-lock loop system. It retails for about \$450 when available in 1978. The receiver is portable in that it can be powered by 8 "D" size batteries as well as AC mains power. The receiver also features LED digital frequency readout on shortwave to the nearest kHz.

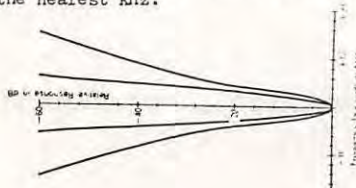

The RF-4800 includes a ladder-type ceramic filter for added selectivity and stability. This is a 4-element type and is used in the "narrow" circuitry of the bandwidth selector. This is rated as  $\pm 1.7$  kHz at  $-6$  dB and  $\pm 6$  kHz at  $60$  dB, better than some more expensive receivers.

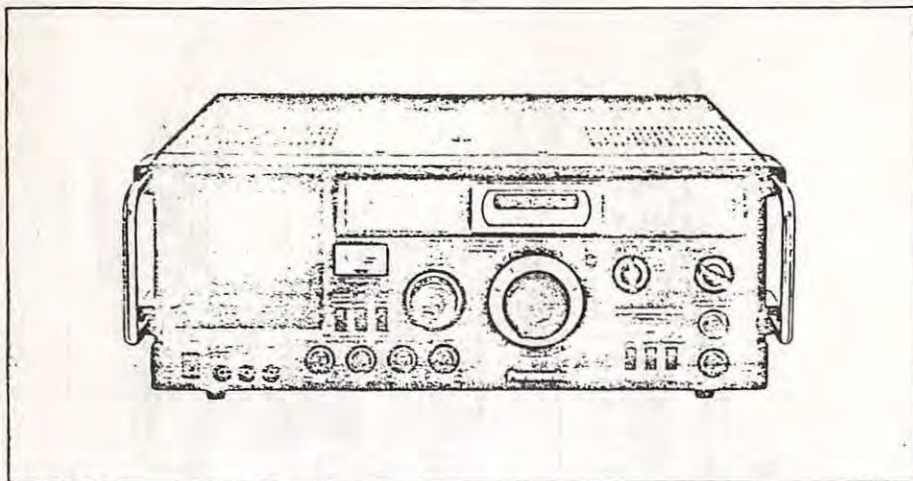

## ■ SPECIFICATIONS

Frequency Range:	FM 88~108 MHz MW 525~1605 kHz (571~187m) SW <sub>1</sub> 1.6~3 MHz (187~100m) SW <sub>2</sub> 3~7 MHz (100~42.9m) SW <sub>3</sub> 7~11 MHz (42.9~27.3m) SW <sub>4</sub> 11~15 MHz (27.3~20m) SW <sub>5</sub> 15~19 MHz (20~15.8m) SW <sub>6</sub> 19~23 MHz (15.8~14.7m) SW <sub>7</sub> 23~27.3 MHz (14.7~11m) SW <sub>8</sub> 27~31 MHz (11.1~9.7m)	Power Source:	AC 120V 60 Hz or 12V (Eight "D" Size Flash-light Batteries) (Panasonic UM-1 or equivalent)
Intermediate Frequency:	FM 10.7 MHz MW/SW <sub>1</sub> 455 kHz SW <sub>2</sub> 1st IF 2 MHz 2nd IF 455 kHz	Power Consumption:	10W (AC Only)
Sensitivity:	FM $4.0 \mu V / m (S/N 30 dB)$ MW $2 \mu V / m (S/N 30 dB)$ MAX 1 P.M.O./m SW <sub>1</sub> $2 \mu V (S/N 30 dB)$ SW <sub>2</sub> $2 \mu V (S/N 30 dB)$ SW <sub>3</sub> $2 \mu V (S/N 30 dB)$ SW <sub>4</sub> $2 \mu V (S/N 30 dB)$ SW <sub>5</sub> $2 \mu V (S/N 30 dB)$ SW <sub>6</sub> $2 \mu V (S/N 30 dB)$ SW <sub>7</sub> $2 \mu V (S/N 30 dB)$ SW <sub>8</sub> $2 \mu V (S/N 30 dB)$	Speaker:	10 cm (4") PM Dynamic Speaker
		Dimensions:	18½(Wide) x 7½(High) x 13½(Dæep) (482 x 200 x 354 mm)
		Weight:	9 kg (19 lb 13.5 oz) with batteries
		Impedance:	Speaker .....4Ω AUX Jack .....300kΩ (20mV) REC OUT Jack .....4kΩ (400mV) Earphone Jack .....4~8Ω FM EXT ANT .....300Ω SW <sub>1</sub> /MW .....75Ω SW <sub>2</sub> ~8 .....75Ω
			SELECTIVITY Wide: ± 2.5 kHz (-6 dB) ± 15 kHz (-60 dB) Narrow: ± 1.7 kHz (-6 dB) ± 6.0 kHz (-60 dB)
		Specifications at further improvement	

# Panasonic

Panasonic Company  
Division of Matsushita Electric  
Corporation of America

Matsushita Electric of America, Inc.  
370 Westchester Road, Paramus, New York 10765

Matsushita Electric of Canada Ltd.  
40 Ronson Drive, Mississauga Ont. M5W 1B5

- A. FET-type RF amplifier and input-tuned type (2-gang variable capacitor) for improved antenna circuitry, thus assuring high sensitivity.  
B. IF stage employs an IC for performance sensitivity and stability.  
C. Five FET's (2 pairs and one singly) are employed for better selectivity.  
D. Ferrite-core antenna can be easily moved in any direction for best reception of the MW and SW<sub>1</sub> bands, thus avoiding unwanted signals.

- A. AF amplifier circuitry employs an IC as well as ITL-OTL circuitry for amplification which is highly reliable.  
B. You can tailor the sound to the best position with separate bass and treble tone controls, for extremely clear tone quality during short-wave reception.  
C. 10 cm PM dynamic speaker includes a 5.5 cm ferrite magnet for faithful reproduction of sound.

SHORTWAVE CENTER WOULD LIKE USER REVIEWS OF THESE RECEIVERS AS SOON AS THEY ARE AVAILABLE.



Shortwave Center presents the survey prepared by David Duke. We hope that receiver designers will use the results of this survey to better plan receiver features to meet the needs of the serious radio listener. I for one am tired of hearing about "almost great" receivers that lack just one or two features, generally in selectivity and/or sensitivity. Any of us who shell out \$250 or more for a receiver intend to make serious use of it and would like to see appropriate selectivity and sensitivity built into the modern generation of receivers. After all, these requirements have been available on receivers for more than 30 years. The problem is getting present day manufacturers to put them on their mass produced receivers, and to convince them that they will have an increase in sales if they do.

We include a survey reply sheet at the end of the survey. We suggest that you make a machine copy of that FRENDX page, indicate your response on the copy, and send it to Mr. Duke at the address provided. Do not send replies to SWC.

SURVEY OF LONGWAVE, MEDIUMWAVE, "MARINE", AND FM BAND FEATURE  
DESIRABILITY IN MULTIBAND PORTABLE AND COMMUNICATIONS RECEIVERS

This survey is being circulated to ascertain the feelings of serious radio listeners towards the inclusion of various features in portable and communications receivers in the over \$250 price range. This survey has not been commissioned by any manufacturer or distributor, and the results obtained will be made available to all manufacturers and distributors of quality multiband receivers in North America.

For the purposes of this survey, please assume that the following description applies to a basic receiver, to which various features are to be added: Large-sized portable or communications format; Basic frequency coverage for MW 525-1605 kHz, SW 3.0-30.0 MHz in 3 bands, and FM 88.0-108.0 MHz; Dual-conversion superheterodyne on SW; Single-conversion superheterodyne on MW and FM; Analog frequency readout dial for all bands; LED digital frequency readout only on SW bands, accuracy to within 1 kHz.

Please indicate your response in the blank provided at the right of the question number on the survey form or reply sheet, if one has been provided, using the following response code: 1--Yes/Frequently/Strongly Agree; 2--Occasionally/Mildly Agree; 3--Undecided; 4--Seldom/Mildly Disagree; 5--No/Never/Strongly Disagree.

Additional comments and suggestions are encouraged. You may indicate your name, club affiliation, and age on the survey form or response sheet if you so desire; it is not mandatory, nor are responses to all of the questions. If it were possible, I would have included a SASE with the questionnaire, but I hope that you will not mind donating a few minutes of your time and a 13¢ stamp for the potential improvement of our hobby. Please send the completed survey or response sheet to:

DAVID JERARD DUKE, WDX5DJJ  
10404 Sigma Drive, El Paso, TEXAS 79924

Your cooperation is sincerely appreciated; results of the survey will be forwarded to each club participating in the survey.

73's,  
*David*

LONGWAVE

- (1a) \_\_\_ Do you ever listen to longwave frequencies?  
 (1b) \_\_\_ Do you listen for European or Far East Broadcast Stations?  
 (1c) \_\_\_ Do you monitor utilities, navigation-/aerobeacons, weather broadcasts or the International CW Distress frequency (500 kHz)?  
 (2) \_\_\_ Do you feel that the addition of a longwave band enhances the utility of a receiver such as described above enough to offset the added cost such an additional band entails?  
 (3a) \_\_\_ Do you feel that longwave coverage of 150-440 kHz (those frequencies used by European and Far East broadcasters) is sufficient coverage for such a receiver?  
 (3b) \_\_\_ Do you feel that longwave coverage of 10-500 kHz (broadcasts plus the other mentioned in (1c) above) is more desirable?  
 (4a) \_\_\_ Do you feel that digital frequency readout on LW is a desirable feature for such a receiver?  
 (4b) \_\_\_ Would digital readout on LW increase your interest in listening to this range of frequencies?

## SURVEY OF FEATURE DESIRABILITY IN RECEIVERS

Of the following methods, which would you prefer to use in a receiver such as described above:

- (5a)\_\_\_ Longwave capability provided by a single-conversion superheterodyne circuit with indirect digital frequency readout? (That is, the same display used for SW frequency readout would be used but you must mentally subtract the LW intermediate frequency (e.g., 455 kHz) from the displayed frequency to obtain the actual LW frequency)
- (5b)\_\_\_ LW capability provided by a single-conversion superheterodyne circuit with its own direct digital frequency readout display, separate from the display used for SW frequencies?
- (5c)\_\_\_ LW capability provided by a frequency convertor which would raise the LW frequencies to some range within the SW bands, such as the 80 meter Amateur band (3.5-4.0 MHz), where the LW signals would be processed using the dual-conversion circuitry and displayed indirectly on the digital frequency readout used for SW frequencies?
- (6a)\_\_\_ Would the presence of LW capability in a receiver be a significant factor in your decision whether or not to purchase that receiver? If so, how would it affect the decision?
- (6b)\_\_\_ Would purchase receiver.
- (6c)\_\_\_ Would not purchase receiver.

## MEDIUMWAVE (Lower Range of Medium Frequency Radio Spectrum)

- (1a)\_\_\_ Do you feel that digital frequency readout on MW is a desirable feature for a receiver such as described above?
- (1b)\_\_\_ Would you prefer the MW frequency to be displayed in its own direct digital frequency readout display, separate from the display used for SW frequencies?
- (1c)\_\_\_ In the interest of price economy, would you prefer the MW frequency to be displayed indirectly using the same digital frequency readout used for SW frequencies? (Again, you would need to mentally subtract the MW IF from the displayed frequency to obtain the actual MW frequency)
- (1d)\_\_\_ Would you prefer to have a MW frequency convertor raise the MW frequencies to some range within the SW bands, where the MW signals would be processed using the dual-conversion circuitry and displayed indirectly on the digital frequency readout used for SW frequencies?
- (2)\_\_\_ Do you feel that MW frequency coverage on all future MW receivers should be extended from the present 525-1605 kHz to 515-1625 kHz to encompass all MW broadcast stations, including the new very low power Travelers' Information Service broadcasts recently inaugurated in the US on 1610 kHz?

## "MARINE" (Upper Range of Medium Frequency Radio Spectrum)

- (1a)\_\_\_ Do you ever listen to "Marine" frequencies (1.6-3.0 MHz)?
- (1b)\_\_\_ Do you listen to the 160 meter Amateur band (1.8-2.0 MHz in North & South America, 1.715-2.0 MHz in Europe & Africa)?
- (1c)\_\_\_ Do you listen to the 120 meter Tropical broadcast band (2.3-2.495 MHz)?
- (1d)\_\_\_ If you do not now listen to this frequency range, would you consider listening if you had a quality receiver which covers this band?

## SURVEY OF FEATURE DESIRABILITY IN RECEIVERS

- (2) \_\_\_ Do you feel that the addition of a "Marine" band enhances the utility of a receiver such as described above enough to offset the added cost such as an additional band entails?
- (3a) \_\_\_ Do you feel that digital frequency readout on "Marine" frequencies is a desirable feature for such a receiver?
- (3b) \_\_\_ Would digital readout on "Marine" frequencies increase your interest in listening to this range of frequencies?
- Of the following methods, which would you prefer to use in a receiver such as described above:
- (4a) \_\_\_ "Marine" capability provided by a single-conversion super-heterodyne circuit with indirect digital frequency readout? (That is, the same display used for SW frequency readout would be used but you must mentally subtract the "Marine" IF from the displayed frequency to obtain the actual "Marine" frequency)
- (4b) \_\_\_ "Marine" capability provided by a single-conversion super-heterodyne circuit with its own direct digital frequency readout display, separate from the one used for SW frequencies?
- (4c) \_\_\_ "Marine" capability provided by a frequency converter which would raise the "Marine" frequencies to some range within the SW bands, where the "Marine" signals would be processed using the dual-conversion circuitry and displayed indirectly on the digital frequency readout used for SW frequencies?
- (5a) \_\_\_ Would the presence of "Marine" capability in a receiver be a significant factor in your decision whether or not to purchase that receiver? If so, how would it affect your decision?
- (5b) \_\_\_ Would purchase receiver
- (5c) \_\_\_ Would not purchase receiver

## FM

- (1) \_\_\_ Do you feel that digital frequency readout on FM is a desirable feature for such a receiver?
- (2) \_\_\_ Would frequency accuracy of the counter/display to 100 kHz (0.1 MHz) be sufficient? If not, please specify your desired degree of accuracy.

## GENERAL

- (1a) \_\_\_ Do you feel that the selectivity of presently available receivers is too broad for MW and SW distant listening?
- (1b) \_\_\_ Would you prefer to own a triple-conversion superheterodyne receiver with the first IF above 30 MHz rather than a dual-conversion superheterodyne receiver with the first IF somewhere in the range of 1.8 through 10.7 MHz?
- (2a) \_\_\_ Do you feel that an internal/external antenna selector switch or switches which ground out the antenna inputs which are not feeding a signal to the receiver circuit to be a desirable feature of a receiver?
- (2b) \_\_\_ Do you feel such a switch to be necessary only on particular bands? If so, please specify: LW, MW, "Marine", SW, FM.
- (3a) \_\_\_ If a 24-hour mode clock could be incorporated into the same IC that is used for a LW, MW, FM frequency counter, would you consider it a useful accessory in a receiver such as the one described in this survey?
- (3b) \_\_\_ Would you desire such a clock to display time to the nearest second?

THANK YOU FOR COMPLETING THIS SURVEY.

SURVEY OF LONGWAVE, MEDIUMWAVE, "MARINE", AND FM BAND FEATURE  
DESIRABILITY IN MULTIBAND PORTABLE AND COMMUNICATIONS RECEIVERS

When completed, please send to: DAVID JERARD DUKE, WDX5DJJ  
10404 Sigma Drive, El Paso, TX 79924

Identifying Information (OPTIONAL):

Name \_\_\_\_\_  
Address \_\_\_\_\_  
Club Affiliation \_\_\_\_\_  
Age \_\_\_\_\_

Survey Responses: Please circle the number corresponding to your response.

LONGWAVE

(1a) 1 2 3 4 5 (3b) 1 2 3 4 5 (5c) 1 2 3 4 5  
(1b) 1 2 3 4 5 (4a) 1 2 3 4 5 (6a) 1 2 3 4 5  
(1c) 1 2 3 4 5 (4b) 1 2 3 4 5 (6b) 1 2 3 4 5  
(2) 1 2 3 4 5 (5a) 1 2 3 4 5 (6c) 1 2 3 4 5  
(3a) 1 2 3 4 5 (5b) 1 2 3 4 5

MEDIUMWAVE

(1a) 1 2 3 4 5 (1c) 1 2 3 4 5 (2) 1 2 3 4 5  
(1b) 1 2 3 4 5 (1d) 1 2 3 4 5

"MARINE"

(1a) 1 2 3 4 5 (2) 1 2 3 4 5 (4c) 1 2 3 4 5  
(1b) 1 2 3 4 5 (3a) 1 2 3 4 5 (5a) 1 2 3 4 5  
(1c) 1 2 3 4 5 (3b) 1 2 3 4 5 (5b) 1 2 3 4 5  
(1d) 1 2 3 4 5 (4a) 1 2 3 4 5 (5c) 1 2 3 4 5  
(4b) 1 2 3 4 5

FM

(1) 1 2 3 4 5 (2) 1 2 3 4 5

GENERAL

(1a) 1 2 3 4 5 (2a) 1 2 3 4 5 (3a) 1 2 3 4 5  
(1b) 1 2 3 4 5 (2b) 1 2 3 4 5 (3b) 1 2 3 4 5

ADDITIONAL COMMENTS/SUGGESTIONS:

---



---



---

## FR to NA

FRENCH LANGUAGE BROADCASTS HEARD IN EASTERN AND CENTRAL NORTH AMERICA

Compiled by Andre Pineault and Maurice Gagnon, Quebec, Canada, via Greg Ravenhorst

Frequencies may change without notice:

EST	GMT	Country and Station	Frequencies
0700-1200	1200-1700	France, RFI	15440, 17780
0830-0900	1330-1400	Sweden, RS	15305
0915-0945	1415-1445	Switzerland	9535
0915-1200	1415-1700	Luxembourg RTL	15350
0900-1200	1400-1700	Belgium, RTB	21460
1300-1330	1800-1830	Poland, RW	9540
1145-1200	1645-1700	Vatican, VR	15125
1330-1400	1830-1900	Bulgaria, RS	9700
1330-1430	1830-1930	Holland, RN	17740, 17810
1330-1700	1830-2200	USA, VoA	15340, 17305
1400-1430	1900-1930	Bulgaria, RS	11765
1400-1900	1900-0000	Zaire, VoZ	15350
1430-1500	1930-2000	USSR, RM	11890
1500-1855	2000-2335	Congo, RTVC	15190
1500-1800	2000-2300	Ivory Coast, RTVI	11920
1500-1550	2000-2030	South Africa, RSA	15155
1500-1600	2000-2100	USA, VoA	11840
1530-1625	2030-2125	Czechoslovakia, RP	11990
1530-1600	2030-2100	Romania, RB	9665
1600-1630	2100-2130	Portugal, RP	9740
1600-1630	2100-2130	Albania, RT	9480
1630-1730	2200-2230	Iraq, RB	9745
1700-1715	2200-2215	Bonaire, TWR	11830
1700-1730	2200-2230	Israel, IBA	7410
1730-1800	2230-2300	Austria, RA	9770
1730-1800	2230-2300	USSR, RM	5920
1930-1945	0030-0045	Greece, EIRT	11730
1950-2005	0050-0105	Chile, VoC	15150, 11700
2000-2030	0100-0130	Austria, ORF	9770
2020-2040	0120-0140	Italy, RAI	11810
2100-2130	0200-0230	Ecuador, HCJB	11830, 9595
2200-2230	0300-0330	Cuba, RHC	11760
2200-2230	0300-0330	Albania, RT	9780

\*\*\*\*\*

## Mailbag

Robert Fabris, 3626 Morrie Dr., San Jose, CA 95127, is forming a R-390A/URR User's Group. Those interested should write Bob soon. Charlie Taylor is planning on being a technical advisor for the group.

Thomas Kenny, 298 Second St., Jersey City, NJ 07302, writes that he is interested in seeing articles in SWC about the proper way to hook a frequency counter into a DX-160. Such articles on other receivers would be of interest also. He is interested also in headphones, particularly the Telex "Twinset, c-1210, and Yaesu YH-55. Reviews of these and other SW accessories would be appreciated by Mr. Kenny, and your SWC Editor also.

The special offer of all four NASWA Special Publications for \$3.00 is good only on orders shipped from St. Joseph, IL. Send your orders to your Shortwave Center Editor.

Dan Ferguson, S. Charleston, WV writes to note that the "multiplication factor" of page SWC-10 of the January FRENDX could be written more simply by using cofunctions as:

$$\cos^{-1}[\sin(LAT_1) \sin(LAT_2) + \cos(LAT_1) \cos(LAT_2) \cos(LONG_1 - LONG_2)]$$

A program supplied with the Texas Instruments programmable SR56 calculator can be modified to calculate the distance from a transmitter to a predetermined location by entering only the coordinates of the transmitter.

It would be an advantage to me if contributors who include circuit drawings or other line drawings prepare them in advance for reproduction by drawing them carefully in black ink on white paper (maximum size 8 x 11 inches). Neat hand written labels are fine.

Gary Ortloff writes and suggests we inform new DXers who may not be aware that Radio Nederland, P. O. Box 222, Hilversum, Holland, has available miscellaneous data sheets of interest to DXers and also offers free technical courses. Write to RN for their most recent flyer describing these services.

Next month we will have more on the SLINKY and a Sanyo receiver, 73s till then, JAL.

# Listeners NOTEBOOK

MARCH 1978



• **Editor: Glenn Hauser, WUOT, U-Tenn.,  
232 C&E Bldg., Knoxville, TN 37916**

## PROPER CREDIT

Other publications and broadcasters may use material from LN provided due credit is rendered to the original reporter and the NASWA Listeners Notebook. This courtesy does not extend to closed organizations which do not allow reciprocal access to their publications. BBC Monitoring Service items are copyright and may not be further reproduced without BBCMS permission. All times, days and dates are day/month GMT, u.o.s.

## ENGLISH SCHEDULES

**AUSTRALIA** Since 28/1, R. Australia has been beaming the GS in EG to Eu & UK at 1800-1900 from Carnarvon 1770; and in USB from Lyndhurst on 11870 (BBCMS 2/2) From 5/3, RA will use new 13m freq to Af 0400-0630: 21525 //15260 (Arthur T. Cushen, M.B.E., NZ)

**AUSTRIA** ORF finally wised up and joined Switzerland, Sweden, Finland in a morning BC to Nam when propagation is more favorable, and QRM lower: at 1230-1255 on 15275 (gh)

**BANGLADESH** RBD sked to ME 0445-0515 15400/17890/21685/25685. Eu 1230-1300 11900/15520/17720/21460. Slow news 1900-1915 7290/9500/11710/15285 (via Nicol-antonio Frammolini, Chieti, Italy, SCDX 24/1) Freqs vary; note 11m, unless it's an error (gh)

**BULGARIA** (Cf Feb LN-2) Some of the info was ambiguously presented and misinterpreted. R. Sofia sked says for M78: 1930-2000 on 9700/11720. 2130-2200 already changed to 9765/9530 as of 2/1 (RCI QRM on 9530); those to Eu. To Nam 0000-0100 on 9707 (sic; probably meant to be 9705 previously used; wavelength equivalent given as 30.91, which is 9705 more or less using the standard but incorrect 300 conversion factor. If the more correct factor of 298.5 were used, 30.91 metres would be 9657 kHz -gh) and at 0430-0500 on 9765 ex-7115 (via Sam Barto, CT)

**FINLAND** R. Finland M78 adds more EG airings, but drops 9550 after 30 years' use. 0930-1000 becomes daily, Eu/NAF 11755/15270; FE/AuAs 17785. 1300-1330 Eu 11755/15330; NAM 15105. 1430-1500 ME 17870; Eu 11755; NAM 15105. 1900-1930 Eu/ME/NAF 11755/15265. 2030-2100 Eu/NAF 9660/11755. 2300-2330 NAM 9645/11735. Sundays: 0800 (or 0830?)-0930 11755/21495; 1330-1430 11755/15330/15105 (David Mawby on Finn-DX 18/2)

**GHANA** R. Ghana still sending out complete xmsn sked but adding that all freqs are suspended except 6130: 100 kW non-directional to WAF at 0600-0800, 1600-1700, 2000-2300 for D77, but probably same for M78 (via Albert E. Cannon, Jr., NC)

**GRENADA** R. Grenada sked per QSL just received 11/2 shows 5 kW on 9550 at 1545-1800; 15105 at 1945-2200; 3300 at 2205-0230 (William McDavitt, NY)

**IRAQ** (Cf Feb LN-2) R. Baghdad exchanged times of FR & EF, so now EG at 2130-2230 on 9745 (Howard Tuffrey, England, SCDX 17/1)

**ISRAEL** Expected IBA M78 sked: 0500-0515 on 7412½/new 9835/11655/11960. 1200-1230 on 11655/15405/15415/17815/21500; low power on 17685/15485/15512. 2000-2030 on 11655/9815 to Eu/NAM; 9425/9009 to Afr; low power on 11960/15105/15415/15512/17685. 2230-2300 on 7412½/9815/11655 to NAM; 9435 to CAM; low power 11960/15105/15415 (Larry Magne, PA)

**KUWAIT** R. Kuwait 0500-0800 now hrd on 9650 //stronger 15150 (A. Grimmig, GFR, SCDX 31/1)

**NEW ZEALAND** RNZ proposed M78 sked. To Pac, 1800-2015 9770, 2030-0345 15380, 0400-0730 15130. 1800-2445 11800, 0100-0620 11850, 0630-1030 6105. To Au 0745-1030 9620 (Tony King)

**NORWAY** R. Norway Sun+GMT Mon M78: 0800-0830 11850/11895/15135. 1200-1230 6015/15345/21730. 1400-1430 9605/17840/21730. 1600-1630 15175/15345/21730. 1800-1830 11860/15345/15175. 2000-2030 9610/11860/15175. 2200-2230 9645/11860/15175. 0000-0030 6180/9550/9605. 0200-0230 6180/9550/9645. 0400-0430 6180/9550/9645. 0600-0630 9645/11850/15175. To NAM underlined (via Dave Walcutt, IL)

**PAKISTAN** Since 21/1, R. Pakistan ES dictation speed EG nx to ME retimed from 1630 to 1600, on 11672/9460/7375 (BBCMS 26/1)

**SRI LANKA** SLBC has been testing 11870 to the UK at 1845-1945 (BBC World Radio Club 8/2)

**UKOGBANI** BBCWS making the usual seasonal/site adjustments for M78. Ascension 15260 runs 120-2245 for NAM, to 2430 for SAM. UK 11750 2000-0230. 9580 Asc opens 2300 (Mar Lon Call)

U S S R R. Moscow M78 Nam svc should be as follows, with listed site, actual site in ( ).  
 9765 2230-0400 Lvov (Plovdiv) 7215 2230-2300 Vinnitsa (Nikolayev)  
 9700 0130-0400 Tula (Sofia) 7205 0130-0400 Armavir (Simferopol')  
 9685 2230-0100 Moscow (Simferopol') 7195 2230-0400 Tula (Simferopol')  
 0130-0400 "Moscow" (Novosibirsk) 7175 2230-0400 Starobelsk (Nikolayev)  
 9665 2300-0300 Ivanofrankovsk (Sofia) 7130 2230-0400 Vinnitsa (Vinnitsa!)  
 7440 2230-0100 "Moscow" (Novosibirsk) (USSR HF Broadcast Newsletter, Feb. 78)

## OTHER SCHEDULES

ALGERIA RTVA has new SAM svc from Bouchaoui site on 9680 at 2200-0430 (Jim Niven, Mt. Gambier, Feb ADXN)

ANGOLA Some changes in R. Nacional's sked: 3375/4820 0400-0800 & 1500-2400. 6175/9660 at 0800-1500. 7245 at 0400-2400. 9535 at 0800-2400. 11955 at 0400-1500 (Richard Ginbey, RSA, SCDX 31/1) The last, 11955, audible after 0400 here (Walcutt, IL; gh)

ARGENTINA R. El Mundo obs on 15290/11755/9708/6120 at 0900-0130. 30 min news at 0930, 1500, 0100; nx summaries on half hour; press review 1000-1030 (BBCMS 26/1)

AUSTRIA Schlungssender des Osterreichischen Bundesheeres can be heard Mon-Fri 0930-1430 on 6221 (Peter Andrewitz, GFR, SCDX 17/1) Unless you're in Nam... (gh)

BOLIVIA (Cf Jan LN-3/4) As usual much of the info from the WRTH LA-News is incorrect, including the following:

3440 R. 27 de Diciembre, Villa Montes, is still here (where it has been operating for several years) and not on 3490. I don't really see why it should move to 3350, particularly since recent Bolivian policy has been to allocate new channels in the 3400-3500 range, nominal fqs being 3420 R. Charcas; 3460 R. San Miguel; 3480 R. Padilla.)

3380 R. Cumbre, correct slogan is La Voz del Trabajador del Bismuto

3465 R. San Miguel, is in Riberaltá, per s/off anmt; nominal freq 3460.

5020 R. Dos de Febrero (hardly new - has been on since 11/76!) \*1100, 0200v\* (-0230v\*), split sked, per anmts.

5020 R. Cuarto Centenario, 0230\* daily. Here at least six months; difficult to catch s/on time during s/off anmt, but is on a half-hour, ???30.

5965 R. Nac. Huanuni, sked is 0930-0400; has been known to operate to 0430\* but never earlier--except local Sundays, when s/off is 0300. Other items...

4640 R. Em 23 de Marzo, now announces \*1100, ex-\*1300. Evening xmsn still 2200-0300.

4725 R. Mamoré (nom, 4750) still regular to 0300\*, occasionally to 0400\*

4738v R. Abaroa, either inactive or changed freq; not hrd since New Year's Eve.

4970v R. Juan XXIII, not hrd for at least 4 months; still nothing as of 3/2.

5312 R. Robore, returned to air 10/1 following 3 mo absence; still 1100-0300; Sun 1100-2400

6015 R. Ánimas, now 1030-1800, 2100-0300 (ex-0400\*) Sun. \*1200

6125 R. Stentor, definitely active; heard to 0400\* early Feb. Nothing heard on any of the R. Illimaní freqs, 6025, 4945. Has been off SW for years (Tony Jones, Paraguay)

CAMBODIA Democratic Cambodian Radio now uses 11943v thruout. Sked 2300-2400, 0400-0500, 1100-1500, all also on 4908v. Closing times vary somewhat. 25m outlet is not announced. 0400 xmsn has been confirmed for the first time (Isaog Ugusa, FE DX Review 28/1)

CHILE Voice of Chile on 1 Feb introduced a new format, of 30-minute xmsns, half talk, half music. Obs on unannounced 17713 ÷ 15150/11705/9566 from fade-in 1730 AR, followed by (times inserted by gh), 1800 GM, 1830 IT, 1900 FR, 1930 EG, 2000 RS (Gordon Weston, BBC WRC 8/2) Then I checked 15130 8-9/2, and found: 2330 EG, 0000 FR, 0030 EG, 0100 SP, 0130 FR, 0200 EG, 0230 SP, 0300 FR, 0330 EG, 0400\* (gh)

DOMINICAN REPUBLIC RTVD has reactivated its IS on 9505, noted \*2100 5/2 & 12/2; thus may be Sundays only (SWNS 2/78)

GHANA R. Ghana non-EG sked on 6130: to Waf FR at 1700-1800 & 1900-2000; Hausa 1800-1900 (via Albert E. Cannon, Jr., NC)

INDONESIA RRI Ujung Pandang now obs on 60mb, 4719 +1000-1305\*; 4986 \*1150-1520v\*; at 1150-1305, they are in //. Local news at 1100 & 1230, relayed by other Nusantara IV stns such as RRI Manado, Gorontalo, Kendari, etc. (Atsunori Ishida, IDXR, via FEDXR) RRI Jayapura now ops on 11942 in local morning, hrd around 2200, probable opening 2100; don't confuse with Singapore & Cambodia!. Eve \*0800-1400\* obs on 6070/4980/3225. Local nx 0930, relayed by other Nusantara V stns, and at 1230 (Satoshi Wakisaka, IDXR, via FEDXR) RRI Palembang, per letter from stn sked: 2230-0200, 0500-0830, 0900-1600 on 4855/2427.5. Obs on 4856; and 2427.5 carries special local pgms. If you hear a station carrying nice kroncong music on 4856, it's RRI-Palembang (Isaog Ugusa, FEDXR)

IRAQ R. Baghdad DS Turkmén pgm at 1030-1400; Syria 1400-1600; on 3242. (BBCMS 26/1) DS "Voice of the Masses" now hrd 0500-1300 on 6155 ex-9745. ES in Urdu confirmed at 1300-1400 on 11905. 1600-1900 Farsi now on 7180 plus 3242 (BBCMS 2/2)

MALDIVES R. Maldives' Asst. Dir, Ali Manik, sent me this sked dated 7/1: 7225 (12 kw) at 0300-0500 & 0900-1100. 6150 (7 kw) 0500-0700 & 1100-1300. 9550 (14 kw) 0700-0900. 3317

(16 kw) 1300-1500. Overseas service on 4740 (30 kw) 1500-1730 (John Moritz, OH)

NEPAL R. Nepal testing new 100 kw xmtr 1020-1120 on 7165, in Nepalese, asking for reports to Test Transmission, R. Nepal, Singha Durbar, Kathmandu (Sukhamoy Gazi, India, SCDX 24/1)

NEW HEBRIDES Vila on 3945 has extended sked since independence. Pidgin hrd up to 0845, then French to 1000 but the stn does not close down with any anthem (Arthur Cushen, NZ) Often noted well past normal s/off time. Pop mx, seasonal greetings at 1145, ex-usual s/off of 0945. Not certain if on new sked, or only on late for special occasions, such as Xmas & NY (Pat Meagher, Victoria, ARDXC, via R. Australia Japanese DX 15/1)

PARAGUAY (CF Jan LN-5) The list of ZP stns active on SW (which is the one I sent to WRTH several months back) is of 'standard' skeds, compiled on basis of local time = GMT - 4h. In fact, Paraguay currently on GMT -3h, and skeds should be changed accordingly (but some-time in March or April they go back to GMT -4h, right? gh) R. Guairá, 5975v, has been off the air for several months, probably because price of electricity was doubled about the time it disappeared. LV de Amambay, 5995; and Em. Paraguay, 6015 are on reduced skeds, former f/in 0850, and transmitting during local daylight; and the latter ending around 2400 or 0100. R. Guaraní, 15210, still off the air. Non-Governmental stns now prohibited by law from operating above 6200. 15210 (and 11915) have been allocated to R. Nacional for future use, when their new xmtrs arrive. However, tests were carried out by R. Guaraní on 15210 during 1977, and their SW equipment has been completely overhauled. Unfortunately there was mutual QRM between SW & MW xmtrs, so the tests had to be suspended. At this time the engr at R. Guaraní left Asunción to visit his own new MW stn, La Voz de Misiones, and has not returned. Whether or not R. Guaraní will continue to operate 15210, after the fault has been corrected, remains to be seen. R. Nacional tests on 9735 started 30/8/77, not in Sept as stated in Jan LN-9. Still uses this freq fairly regularly, 0900-1700 & 2000-0300 (Tony Jones, Paraguay, 5/2)

PORTUGAL R. Portugal now has a weekly Esperanto BC Mon at 0320 & 0520 on 11935/6025; and on Sun at 1730 on 17880/15340; 2050 on 9740/6025 (Gordon Weston, BBC WRC 8/2) That puts it within EG.xmnsns, the first two listed, for NAM (gh) The new pgm in PT for Portuguese emigrants in Eu, begun 9/1, at 1100-1300 on 15125/11800/9740, is weekdays only (BBCMS 19/1)

SPAIN At beginning of Jan, RES (R. Exterior de España) changed some stuff. 1830-1930 (exc. Sun) SP to NE, replaced by an extra daily Gen Svc in SP 1630-1730 on 11810/9695/9685/7130/6090/6045. AR to NE now daily exc. Sun 1800-1900, 1900-1930, 1930-2030 on 11810/9695/7130 (BBCMS 19/1)

SURINAM Paramaribo 4850 now 10 kW hrd with strong signals \*0830 Indo to 0930 Dutch (Arthur Cushen, NZ) See also LN-10

THAILAND R. Thailand ES sked just received 5/2 with QSL: 11905 50 kW; 9655 100 kW: EG 2330-0155, 0415-0515, 1055-1155. FR 0520-0550. Lao 0915-1000. Mandarin 1000-1030. Thai 1035-1055. Viet 1200-1230, Cambodian 1230-1300, Malay 1305-1350, Burmese 1355-1425 (Dale Bohlke, MN)

U S A WYFR M78 to the Americas; shows two Okeechobee xmtrs in use: Sun SP 1300-1551 17730. Rest daily: SP 2300-0200 15265. PT 2300-2400 15215. SP 0000-0200 15215. SP 0200-0500 on 11855 & 9715. Other usual freqs of WYFR to the Ams, 15440, 17875, 15130, 17845, 15130, 9525, 6155, 5985, are from Scituate, as is 11855 at other times than above (WYFR via gh)

U S S R Some interesting listings in the Mar/April IFRB to watch for: 17800 Baku 1430-1730 Af. 11890 Frunze 2200-0400 SAM. 11850 Frunze 2230-0400 SAM. 11740 Frunze 0930-1600 SAs. 11730 Yerevan 0130-0530 SAs. 11715 Dushanbé 1500-2100 EAF. 9760 Tbilisi 2330-0330 to Azores. 9660 Tashkent 2200-0400 SAM (UHN)

VIETNAM VOV as of 1/78; on 15012, 12035, 10040, 9840, 7512, 7290: 16½-17 Russ 12 10 7

00-01 Cant 12 9 7½ 09-09½ Engl 12 10 7 12-13 Japa 15 12 17-18 Viet 10 7

Indo 10 7 09-10 Camb 9 7½ 13-14 Camb 9 7½ 18-19 Engl 10 7

01-02 Fren 12 10 7 09½-10 Indo 12 10 7 Fren 12 10 7 19-19½ Fren 10 7

02-02½ SP 12 10 7 10-10½ Engl 12 10 7 14-14½ Std Ch 12 10 7 19½-20½ Fren 10 7

03-03½ Laot 9 7½ Laot 9 7½ Laot 9 7½ 20½-21½ Engl 10 7

03½-04 Laot 9 7½ 10½-11 Indo 12 10 7 14½-15 Cant 9 7½ 21½-22 Russ 12 10 7

Std Ch 12 10 7 Laot 9 7½ Japa 15 12 22-23 Japa 12 10

04-04½ Russ 12 10 7 11-11½ Span 12 10 7 15-16 Std Ch 9 7½ 22½-23 Laot 9 7½

04-05 Camb 9 7½ 11-12 Camb 9 7½ 15½-16 Std Ch 12 23-23½ Std Ch 12 10 7

04½-05 Cant 12 10 7 11½-12 Thai 12 10 7 15½-16½ Engl 10 7 23-24 Camb 9 7½

05-05½ Thai 10 7 12-13 Indo 9 7½ 16-16½ Thai 9 7½ 23½-24 Thai 12 10 7

-VOV-D8 from Ho Chi Minh City ops only in-Viet, 2200-1530 on 9620/6165. Relays (BBC MS)

Hanoi news at 2300-2330, 0400-0430, 1100-1130, 1430-1500; and Hanoi's army pgm 1400-1430.

(BBCMS 12/78) Lai Chau provincial stn obs 0400-0530 on 5992; music and local nx in Viet &

tribal langs (BBCMS 26/1) Son La regional obs in Viet & local minority lang 1200-1400 on

6332/4770. Cao Lang regional in Viet & mtn dialects 1100-1400 on 4785 (BBCMS 2/2).

YUGOSLAVIA R. Yugoslavia send a sked identical to that of R. Belgrade in WRTH W7, except

WRTHVH omitted FR 1930-2000 on 6100/7240/9620 (via Sam Barto, CT)

**MISCELÁNEA RADIAL** **ANGOLA** AFP reports a decree of Pres. Agostinho Neto on Wed shut R. Ecclésia and nationalized all of its assets. An estimated 40% of Angola's 6 million people are Catholic. The decree said Angola is now a secular state and that all news outlets must be under government control (Lewis H. Dinguid, Washington Post, 2/7/1 via Hadley Cress, VA) Before the nationalization the R. Ecclésia xmters were silent (Richard Ginbey, RSA, SCDX 31/1) The stn had been set up in line with the concordat between Portugal and the Catholic Church. This was not binding on Angola and the stn has been integrated into the info & propaganda apparatus of the MPLA (BBCMS 2/2)

**ARGENTINA** (Cf Jan LN-7) Indeed it is R. Rivadavia, heard regularly on 9115 for several months. Stn is generally considered number one in Argentina for sports coverage, and it is quite possible this is a feeder to provincial stns; another possibility is that it is used as marker by MinCom like Chaco Boreal & Primero de Marzo are in Paraguay, and R. Colo Colo is in Chile. (Tony Jones, Paraguay)

**BENIN** LV Révolution hrd in Spanish with hi-life mx and 'revolución' trash. Positive ID in SP at 2211 after song. No sked given, and in FR at 2219; 18/1. On 4870. Spanish yes, but to where? (Richard Stoller, NY)

**BRAZIL** R. Borborema got its name from the mountain of the same name, called originally 'pora-pora-eyma', meaning a sterile, unpopulated place. A good description of NE Brazil is in Da Cunha's *Os Sertões*, a good xltm of which, *Rebellion in the Backlands*, is available from Phoenix Books. Makes good background info (Pitt McNeil, DC)

**CANADA** (Cf Feb LN-8) CHU denies that it was transmitting on 9173; a monitoring station checked and couldn't hear it either (Ian McFarland, RCI DX Digest 12/2) Nevertheless, I'm positive it was there, as I heard full voice ID several times after my previous report (Dave Walcutt, IL) I heard CHU had been completely off the air for a day or two, so they may have had problems. By the way, on all 3 normal frequencies, CHU has been using A3H for some time--that is, suppressed LSB by 60 db, a kind of compatible SSB which has been proposed for SWBC (Larry Magne, PA) CHU, all flesh blood and static heard on 9990 just below WWV, at 0545 12/2. Probably a spur, tho (Daniel Gallagher, TX) No, 3 x 3330! (gh)

**CAPE VERDE** R. São Vicente BCs in PT on 3860 (Maria José Silveira, Azores, SCDX 10/1)

**COLOMBIA** R. Melodía, Bogotá, new on SW tho announcing MW only, hrd on 6140 at 1029 26/1 (Jack Jones, MS) First hrd 2/2 at 0900. Many ID, slogan 'la fabulosa de la capital', etc. Announces also for "Cadena Líder". Must be 24h, hrd anytime, including 0800 RNE QRM (Jerry Berg, MA)

**COSTA RICA** Since 20/12/77, R. Cu-Cu, 675 in San Jose has been obs with mx only on 6253 (BBCMS 19/1) Typo for 625 kHz? (gh) Altho TIFC has been hrd announcing 3 SW freqs at once, they have, acc. to the stn, only two SW xmters but one of these has been reconstructed and its power boosted to 5 kW. They indicate this is the one on 5055 kHz (SWNS Feb)

**CRETE** (Cf Dec LN-6) Is the 1614 kHz stn R. Ierapetra? If so, is or was an excellent verifier. Was hrd in the UK some years back varying 1605-1615 (Tony Jones, Paraguay) Tunér may have given such a name, but I didn't catch it (gh)

**CHILE** Re speculation on R. Colo Colo, the stn is in fact Govt-owned, per a friend who visited Santiago, and in same building as CB114 R. Nacional; but pgming of the two is quite distinct. In early days it legitimately operated on the R. Nacional freq of 6190, but has not been on SW since. The OOB xmsns reported are via Min. Com. facilities, used by them for testing. R. Colo Colo & R. Agricultura are both used for this since they both have relatively new xmters and the broadcast quality is better than other stns. R. Nacional hrd on 49m for first time in some time, on 6190 2/2 1100, ex-6195 (Tony Jones, Paraguay) Noted at 1000, maybe s/on, listing many other stns carrying pgm, ex-6195 on 6190 13/2 (Jack Jones)

**FRANCE** France-Culture often hrd on 4964, Marseilles 4 x 1241, around 1800/1900 (Gordon M. Darling, UK, WDXC Jan Mid-Monther)

**GREENLAND** Godthaab's IS can be heard certain days on 9575 just prior to 1500 and 1900. Xmitting hours seem rather irregular; fair-to-good signal sometimes (Victor C. Jaar, PQ)

**GUATEMALA** After hearing R. Coari as my first 120m DX catch, got a positive log of R. Tezulutlán on 2340 at 0200-0300, SIO 232. WRTM & TBS wrong with "2400\*" (R. Stoller, NY)

**GUAM** (oops) KTRW noted regularly in late Jan 1100-1400 on 15195, then 15190 to 1500. Both freqs bad with France, Japan, VOA, Brazil QRM. Why change to 15190 at 1400? (Tony Jones, Paraguay) TWR is restricted by the FCC in that they must submit freq selections/requests to the FCC months before switching to the freq (if the FCC approves) and if another stn moves to that freq in the interim, TWR can do nothing but use the FCC-assigned freq. Their inability, by FCC regs to switch freqs at will is causing serious problems as can be seen in monthly reports of stns TWR is QRMing. The Engineering Dept. of TWR-Guam is in urgent need of volunteer monitors in Japan to assist them in choosing future bands/frequencies which, hopefully, will allow them to minimize QRM to other international broadcasters (Mike Hardester, Japan)

INDONESIA RRI-Díli reactivated 2456 kHz //3120, hrd to 1520v\* (Atsunori Ishida, IDXR, via FEDXR) Due to change of Nusantara Net last July, RRI Díli now belongs to Nusantara IV. Formerly hrd to 1400\*. Strength of 3120 kHz says Díli operates 10 kW there (Ugusa, FEDXR) UnID RRI hrd around 1200 on 3850 in late-Dec, Jak news relay 1200. Not //Díli (Ishida, IDXR via FEDXR) Same spot as one-time Timor claud. DUDXS says hrd at 0930-1302\*, located in Timor and perhaps local govt operated (Isao Ugusa, FEDXR editor)

KENYA Apparent new high power xmtr on 4933, noted 27/1 Swahili nx 2000, Christian prayers 2004, Islamic prayers 2008, anthem, 2013\*; also as early as 1508 28/1 (P. Bunn, ADXN)

LEBANON (Cf Jan LN-8; Feb LR-C 6550) Voice of Lebanon, fair-to-good reception in AR, 29/12 & 7/1 at 1750-2200\* (PLAY-DX) Tnx to Dan Robinson tip on new \*0448, hrd with chimes like IS, whistled theme from Bridge Over River Kwai, long choral anthem, woman in Arabic with ID and talks interspersed between Muzak selections--nothing Arabic except the lang (Pitt McNeil, 6/2) Also hrd here on first check, 10/2 closer to 6549, from 0507 tune in, to fade out around 0550. This window will diminish as summer approaches. Per SPEEDX table, sunrise times in Beirut for mid-month are: Feb 0413, Mar 0344, Apr 0311, May 0245, Jun 0230 (gh) Arab stn reported lately on 6550 may not be Voice of Lebanon as it has been heard here with Qur'an recitations, and VOL is operated by Christian Phalangists (David Crawford, FL) R. Lebanon's AR DS recently obs on 9545 ex-9550 during daylight (BBCMS 2/2)

MOROCCO Rabat DS in AR hd all day and much of GMT eves on 7358.8 USE, first noted 15/1, badly QRMG Moscow 7360 (Andy Sennitt & Stephen Lowe, WDXC Jan mid-monther)

NEPAL R. Nepal's 5 kW standby xmtr has been hrd on 3230 in EG at 1500 //3425/5007 (Victor Goonetilleke, RN DX Juke Box 27/1)

PAKISTAN R. Pakistan-Peshawar now on 3160 ex-3155. Karachi, cf Feb LN-4, can not be hrd on 4735 at 1400-1615 & 1630-1810. R. Pak AR svc now on 4719 at \*1715 //9645 (Satoshi Wakisaka, Japan, 8/2)

PAPUA NEW GUINEA While 75, 90 and 120mb stns have their own programs, these 49m stns relay Port Moresby, 10 kW each: R. East New Britain, Rabaul, 5985; R. Milne Bay, Alotau, 6040; R. Western District, Daru, 6080; R. East Sepik, Wewak, 6140. Remainder of stn list now being sent out is same as WRTVH 77 (via Robbie Berezowski, Alta; Greg Danylichenko, Ont.)

PERU These stns are officially inactive on SW: R. Ayacucho 4772, R. Sullana 4845, R. Yarincocha 4905, R. Abancay 5082. Officially active are: R. El Sol de los Andes 3230, R. Qollasuyo 3250, R. Junín 3300, Ondas del Huallaga 3330, R. Cooperativa Satipo 4785, La Nueva Voz del Centro 4800, La Perla del Sur 4825, R. Libertad 4910, R. Ucayala 4950, R. San Cristóbal de Huamanga 5020, and R. Avaviri 5035 (Peroy Fernández Pilco, Dir. of Telecomms. in Peru, via John Tuchscherer, via John Moritz Jr. in Fine Tuning, via Jim Whitehead, Feb SPEEDX, who adds:) This is not a complete list as the letter was responsive only to John's questions about these seldom heard stations. Moreover, as it was an official response, it listed the nominal assigned freqs, and many have been obs operating on other freqs.

PHILIPPINES R. Veritas Overseas has been changed to R. Veritas Asia (RVA). Fr. Anton Weerasinghe, S.J., RVA Consultant said the change is to specifically identify the stn as a stn of Asians for Asian broadcasts. He adds that RVA receives an average of 8000 letters a month from listeners in 16 Asian countries (RVA "Wavelength" via Joseph Vargo, MI) Tnx for the sked, Joseph, but is out of date by publication of this FRENDX issue (gh) AFRTS Poro relay was discontinued 6/11 at 0000, apparently a late decision, as was listed in the D77 VOA sked. No longer required, as original purpose was to serve US forces in SEAs. The xmtr used, Poro-2, 35 kW has joined Poro-1 (35 kW) and Poro-4 (15) on the USIA RITY "Wireless File" at 2330 Mon-Fri, on 14526 to Indo & Au, 11490 and 9870. One of the 10 250 kW VOA xmtrs at Tinang (PHT-6) is kept on permanent standby. On some days it is used, airing taped music, on one of the authorized VOA-Phil test freqs: 3995/6040/7295/9630/11715/15200/17710 or 21490. Hrd during Jan on 11715/15200/17710. Also sometimes plays taped music from half an hour to an hour before BCs begin, and when reception of US feed is of poor quality (Robert Jones, Sydney, Feb ADXN)

REUNION In response to my letter, M. L. Larrieu, R & TV Technical Manager at St. Denis says "First, we stopped our SW xmsns because, from the middle of the Indian Ocean with only 4 kW, we reached a small amount of people. Secondly, the SW xmtrs were installed in the base of the R & TV production center and brought a lot of RF troubles in the wirings and especially in the low level circuits." Asked if there were any protests from DXers, M. Larrieu said that "After we decided to turn off our SW xmsns, nobody but only 3 or 4 persons wrote and asked us about the SW. This fact confirmed ourselves in our position about this decision." Finally, in response to my query as to phony or bogus reports, he replied that "The small power of our xmtrs explain the poor reports we ever receive from anywhere around the world but it was not very important because our program had no international design." Now operates only on 665 & 602 kHz, 0200-1900 (John Moritz, OH)

TURKEY Türkiye Polis Radyosu, 6340 at \*0558 bells like IS, rousing choral anthem, man in Turkish with short talk, into straight cuts of Turkish mx past 0632 (Pitt McNeil, DC, 6/2)

(UNITED NATIONS) (Cf Feb LN-10/11) UN Radio's anti-apartheid BCs to South Africa will be carried by the VOA from Liberia and on MW from Botswana on 971 kHz, and from Mozambique either on 917 or on the National "A" programme. Other African stations to relay the broadcast include Zambia, Tanzania, Uganda, Ghana and Nigeria. Also expected to help relay the programs are the European ISWBC stations previously mentioned, with the exception of the BBC, which has declined (Richard Ginbey, RSA, SCDX 31/1)

U S A Looks like WYFR Scituate site survived recent storm, as heard with ID at 2200 11/2 on 6055. Scituate beach area, where xmtir is located, was extremely hard hit in storm--houses washed away, lives lost, etc. (Jerry Berg, Lexington MA)

U S S R Most ES freqs are listed in the IFRB sked as 240 kW, some with 100 kW. Most internal svc freqs are listed as 100 kW, some 240 kW. 7195 & 7205, two of the strongest signals on the R. Moscow NAM svc, are listed in the IFRB sked as 100 kW. The comparative strength with other frequencies indicates actual powers of at least 240 kW, and probably 500 kW, since strength is the same as the 500 kW Plovdiv relay on 7115. The R. Tashkent SAs svc is listed as 50 kW on 6025/9600/15115 and 100 kW on 9540/11730/11925. Signal strength in NAM at 1200 GMT indicates power of 240 kW (Roger Legge, Jan UHN) Sverdlvskoye Radio now using 4860 for regional svc, sometimes audible around 1300, when local pgms are BC in RS weekdays to 1400; otherwise relay MIEU (Moscow Pgm I for Euro USSR, Ural, Caucasus and Turkmenia). Heard at the end of Dec 1977 (Takahiro Saito, FEDXR)

VENEZUELA R. Carora has appeared on 4907, around 1030 24/1 (Jack Jones, MS) R. Nacional's ES, formerly at 1900-2400 on 15390/11750, has not been obs recently here nor on 6170, which does carry R. Nacional's DS //MW (BBCMS 19/1) It was most recently on 15400, not 15390(gh)

## CLANDESTINE CRANNY

R. Rebelde is a very interesting clandestine which claims to be operating from a hidden place in Cuba. Of course, R. Rebelde was the name used by Castro during his guerrilla days, and is still the name of one of the national nets in Cuba, but this is different. I heard it once around Thanksgiving, then not again until Dec. 25 & 26, on about 7000 to 7025 kHz between 2000 and 2200. It began with several short anmts that it would soon read a Christmas message written by a Cuban mother. The transmitter would go off the air for 5 to 10 minutes. Then the message condemned Castro, especially his sending Cuban soliders to Angola. Also used the slogan "La voz que no tiene mordaza" = The voice without a gag. Reception was on a par with ham stations from Cuba on 40m. I do not think it was operating from here in Miami, because there was fading (Timothy Hendel) Tim sent me a tape of this, excerpts of which have been included on my March 10 (+11 GMT) report on R. Nederland's Espacio DX-ista, from which I also gleaned: At one point it called another station "Segundo Frente Patriótico Militar Único Móvil en la provincia---". Also called "CQ 40, from COBRR, in Santiago de Cuba". On AM; "R. Rebelde, unida a R. Libertad Cubana". Intermittent QRM from a station playing music, which this stn also heard and blamed on the Cuban government. At conclusion, speaker IDed self as "El Comandante Abito(?)" (gh) Also check 3850 (D. Crawford)

R. Sandino (cf Feb LN-9) has not been confirmed by monitoring observations (BBCMS 26/1)

New York pirate(s) (Cf Feb LN-9; LR-A) WPAT, WPOP, WPOT, WPLC were among the IDs used by a pirate hrd 21/1 at 2315-2400\*, announced freq 1625 kHz; phone-in talk show, some rock mx. Gave number (212) 830-9900. Annc'd QTH as Manhattan, the most callers were from Brooklyn. DJ "Jack" or "Vito" annc'd it as a pirate station and "illegal radio stn". Final ID was WPLT, with the sounds of muffled shouts and pounding on a door. Signal at my QTH, 100 km from NYC, was fair, severe fade; signal lacked directionality. I was surprised at the number of people calling in. The day was perfect to run a pirate. It was a weekend, the day after a snowstorm. A lot of people were indoors; potentially big audience. Plus impossible traveling conditions would hinder direction finding and any possible FCC action. And around 1630 kHz 7/2 from 0400, another phone-in stn with some cursing, during the big snowstorm; no ID hrd. 8/2 on 1630 0130-0200, DJ claimed he was only on during snowstorms. Annc'd QTH as NYC. Phone (212) 391-9979; said another pirate would be on at 10 p.m. EST, but I did not hear this. Yet another one on 3886 kHz 6/2, 0135-0143\*, \*0147-0200\* playing mellow pop music; strong carrier, weak audio, no talk, heavy QRM, no ID, off suddenly (Steven Kontos, Centereach NY)

WFSR, "Free Speech Radio" hrd 7/2 from 0820 to 0900 on about 1626 kHz, weak sig, "a radio stn run by people with little money and simple equipment". Used regular call-in format, number 830-9900. Phone was answered without ringing. Annc'd he was in Brooklyn, using store-bought ham equipment, horizontal long wire antenna, radiating approx 20-40 w. Admitted that WFSR was formerly WICE; I read FRENDX Feb LR to him, and he said the calls were paid for, not underhanded. Said he was with WCPR in 1976, the only time he was busted. Why he does it? He believes in the principle of free speech radio and it is an interesting challenge for him (Michael J. Youndt, Denver PA)

WGOR, Brooklyn, hrd on 1630v, this past Sat & Sun nites local dates around 0400-0445+ GMT. Mostly call-in, various numbers, all with 9900+ last four digits like WCPR used. Also hrd last Fri at 0500 IDing as WICE, parody of wx situation then. Also hrd then but not subsequently on second harmonic 3260.6 (Pitt McNeil, DC, 23/1) more....

The NYC pirates were putting on a real circus in mid-Jan. WICE "Free Speech Radio" noted on 1626 from 0200 21/1 taking phone calls at 212-399-9977. Noted same date at SWNS HQ with fair signals from 0320 tunein. By then, SWNS Correspondent Robert L. Foxworth, Long Island, reports they were up around 1630 tho announcing 1625 kHz. About half the callers wanted to, quite literally, just make noise on the air--much to the station's disgust. Subsequently switched phone numbers to 830-9900, another 'loop' number normally used for internal phone company operations only. Still going at 0740. What Foxworth believes to be the same stn, but called WPOT, was noted on LI and at SWNS HQ same date 2300- on 1626.3, drifting down to 1625.9 by 2350. During this period, SWNS HQ noted a second NYC phone-in pirate, announcing as 1620, not audible, but hrd poorly on about 3240, not //WPOT. Foxworth caught WPOT abruptly signing off at 2358 which sounded as if they were being busted--the announcer certainly seemed anxious to get off the air. At 0130 WGOR definitely audible on about 1630, and on 5/2 at 0330. WGOR previously logged 0405 16/1 with porno phone call. Shortly before 0500 someone called claiming to represent WPCR (the original phone-in pirate) and complaining that WGOR had taken over WPCR's freq. Despite this, we believe all these stns are connected: they are all able to tamper with the phone system (Feb SWNS)

WGOR hrd 22/1 0545-0630, fair-to-good, 399-9979; DJ said GOR stands for "Get-Off Radio ...no, I mean Get On Radio" (John Czarnowski, Staten Island NY, IRCA DX Monitor) On 1620. WFEAT, NY, 1630; hrd 1/1 0535-0623 tuneout, weak, lots of fading, talk show, 212-830-9906 and lots of calls were from DXers, including me (David Nelson, Chapel Hill NC, IRCA DXM)

KUGR. I operate pirate stn "Cougar", "King Underground Radio". This station is highly clandestine--so much so that I will not reveal its frequency. It is on MW, however, with 100 milliwatts power, and a 10 foot antenna, as permitted by the FCC's Part 15. KUGR operates whenever I damn well please. Program policy is to rebroadcast noisy SW stns for the enjoyment and edification of the general public. Any DXer hearing KUGR should write and I will make up some sort of QSL. Personal visits and phone calls are highly discouraged and will not be QSLed (Shaler Hanisch, 940 Hillcrest Pl., Pasadena, CA 91106)

Voice of Namibia via Tanzania 15435 1830-1900 EG, not as per BBCMS sked (Pitt McNeil, 3/2)

Voice of Zimbabwe via Maputo, Mozambique, noted with EG political nx at 1715 on 9570; is presented by ZANU (Ron Knight, Papua New Guinea, via R. Australia Japanese DX 15/1) Will the 'settlement' in Rhodesia have put an end to these particular clandestine programs? (gh)  
Zimbabwe People's Revolutionary Voice in EG & verna, 1700-1745 via R. Zambia 9580/7235/6165/6060 (BBCMS 2/2)

Voice of the Free Canary Islands, via Algiers had not been heard the past few days, R. Exterior de España reported 27/1, maybe due to approaches made to Algeria by the Spanish govt. Monitoring obs confirm the pgm is no longer BC on 7060 at previously sked time of 2100-2200, which now carry R. Algiers DS in FR; but still carries ES in EG & SP at 1900-2100 as before (BBCMS 2/2)

Voice of Arab Syria & Voice of One Lebanon. "VOAS" not hrd since yearend, presumed discontinued; but VOOL continues on its same freqs, 9510/6060 at 1030-1130 & 2030-2130. Now evident this from Iraq, since on 9510/6060 at 1030 10/1 were relaying R. Baghdad's Turkmen svc instead of VOOL. By 1040, both freqs had switched to the correct pgm (BBCMS 19/1)

Voice of Palestine is the name of a feature carried on R. Baghdad's ES in EG to Eu on 9745, Thu (26/1) at 2150, announced as being presented by RB itself--a 4-min talk ridiculing the Zionist's view of Israel as a 'Jewish home land'; assumed repeated Fri 0350 to NAM (BBCMS)

Voice of the Oman Revolution During Aden Radio's VOOR pgm 12/1, it was stated that the pgm presented by the PFLO has been BC at 2030 from Libya since 8/1. Obs 16 & 17/1 on 9650 revealed it during Libya's external svc "Voice of the Arab Homeland" at 2000-2015 (BBCMS 19/1) Ditto, and also on 9500, 6100 (BBCMS 26/1)

Voice of the Communist Party of Turkey anc'd that from 1/2 it would increase output to: 0400-0430, 0810-0840, 1640-1715, 1815-1900, 2030-2100, 2200-2245; anc'd W/Ls 31.5 and 48.5 metres. Those daily; said would also continue Tue & Thu 2015-2045 on 908 kHz (BBCMS 2/2)

**FUTURE PLANS** ARGENTINA (Cf Jan LN-11) The Dir. of the govt's General BCing Directorate stated 23/1, per Arg. news agency Telam, that the BC law permits the return of commercial stns to private firms. Present plans include the releasing of 53 such radio stns to commercial enterprises (BBCMS 2/2)

AUSTRALIA The two 100 kW Harris Gates xmtrs are now being installed at Shepparton, and when these are ready, two of the older 100 kW units will be temporarily withdrawn from service, whilst building alterations are carried out around them. It is planned that a revised sked will commence in Nov, using all six 100 kW units. The new units will require only a 5 min break between xmsns rather than 30 mins; also; no tone tests (R. Jones, ADXN)

BRAZIL (Cf Jan LN-11) The report is not entirely correct. An engineer with DENTEL was in Asunción a few months back, and said they intend to transfer all non-govt stns from the HF bands and re-allocate them freqs in the Tropical and MW bands. At least some, if not all of the vacated HF channels will then be used for Govt stns. The engr did not specify if the 49mb was to be included among the HF bands, but this seems unlikely. (Tony Jones, Pgy)

**COSTA RICA** Watch for possible curtailment of Radio Cadena Nacional ops in wake of the 5/2 election defeat of the ruling National Liberation Party's presidential candidate by Rodrigo Carazo of the Unity Coalition. RCN was put together in the early 1970s during the second term of NLP's José "Pepe" Figueres. Carazo has also promised to expel fugitive US financier Robert Vesco who is known to have invested in various Figueres business interests and was described in the 30/7/75 Variety as having 'various communications interests' in CR (SWNS)

**DOMINICAN REPUBLIC** On R. Clarín, Rudy Espinal mentioned 8/2 that they would soon add a broadcast in EG at 0030, "news for you, Glenn Hauser" (Ed Ricchezza, PA) It was not certain at that point, but it would be done by a new ancr, Erminio Alberti, who might also substitute for Rudy while he spends 53 days in the US attending various broadcasting seminars, in Washington DC, Las Vegas, San Francisco, and during most of March at Syracuse Univ in New York. On 9/2 I interviewed Rudy by phone on the air. He said they were going to convert the 60m xmtr on 4850 to a MW repeater, where it would do more good. The management has not yet bought the idea of getting a directional antenna for 25m. They are also thinking of repeating the 2130 broadcast at 0230 when reception is best in Australia and NZ. And, Rudy has offered the GMT Sun 0000-0030 block for the use of DX clubs. I expect that a monthly "Review of International Broadcasting Of the Air" will be among the features, if Rudy's absence does not hinder (gh)

**HAMMARLUND**'s remaining assets have been purchased by Pax Manufacturing Corp, 100 East Montauk Hwy, Lindenhurst NY 11757. In a letter to WTFDA ANARC Rep Morrie Goldman, Robert Kjeldsen says "We will manufacture all of the HQ 180, SP 600 and R 390 series. We will also supply spares for all of the former equipment." (Jan ANARC Newsletter)

**HONDURAS** La Voz de Honduras announced 26/1 that a formal request had been made to R. Nederland for assistance, to give 'a special dynamism to R. Honduras from both the technical and programming standpoints in order to best publicize activities in culture, education, science and art'. The country's official stn would cease to be a bad copy of R. Havana, Cuba. It would no longer indulge in demagogy and diatribe against national banking, commerce and industry, and attacks on the military regimes of other CAM countries. It rates RN as 'perhaps the most professional stn in the world, on a par with the BBC' (BBCMS 2/2) This may relate to a visit recently made by an RN training team to R. Clarín as well, regarding the establishment of a training centre on Bonaire (gh)

**IVORY COAST** Following a visit of the French President, France-Inter reported 15/1 that the I.C. radio and TV net is to be modernized and extended at a cost of one billion francs (BBCMS 19/1)

**MASIRAH** BBC's 1412 kHz relay, put out of action by cyclone 13/6/77, is back on the air. Four 100 kW SW xmtrs are being installed and should be in use by mid-year (Arthur Cushen)

**SHORTRANGE RADAR** Jan Wireless World reports as follows on the US SW radar facility currently being developed by GE and E-Systems for operation in Maine: "Work involves tests in a nominal freq range between 6 and 30 MHz using a pulse compression waveform having a typical repetition frequency of 40 pulses per second. Mr. W. Fenster of GE was asked jokingly by a radar symposium delegate, "What are we going to do about those damned communications in the HF bands?" His equally jocular reply was "Oh, we'll just switch on." However, he did explain that altho efforts are made to ensure xmsn freqs are chosen to coincide with clear channels, stns operating in the target area or elsewhere are not necessarily hrd at the xmtr site due to the nature of ionospheric propagation." (SWNS)

**SWITZERLAND** (Cf Feb LN-11) The SSB tests are definitely on starting in May for a year to NAM (Swiss SW Merry Go Round 28/1 via Pete Grenier, CA)

**TURKEY** VOT info state there will be further changes in the ES when two new xmtrs commence operation in late spring or early summer (BBCMS 26/1)

**YUGOSLAVIA** Tho R. Yugoslavia begins as nothing but a new name for R. Belgrade, big things are in store, tho no spectacular differences should be expected straight away. The Dir. of RY said new equipment will be purchased to increase the stn's audibility to 10, 15 or 20 times the present level. It was hoped to improve audibility of xmsns beamed to the Arab World, Asia, Lam, Af and also Eu (BBCMS 2/2)

**UNIDENTIFIED** 2340 (Cf Jan LN-10) I think it's R. Nueva Esparta, 0359\*, on the beautiful island of Margarita, which is what Mr. Perdue may have heard instead of "Bogotá" (Jack Limann, Caracas, 18/1)

4719 Stn hrd almost daily from fade in 2130, 2200 peak, gone by 2230. Seems Asian, and on good day might have hrd RRI ID at 2200, but no IS. Could be Ujung Pandang but seems whacky. Pretty sure it's not Pakistan, as they were on 4718 11/2 while mystery was very weak on 4719 (Jerry Berg, MA) Karachi 4735 has drifted to 4718, at 0045-1810, 1915-2145, latter time feeding WS to Islamabad (BBC WRC 15/2) Tashkent on new 4718 \*1714 in Arabic (Satoshi Wakisaka, JADX, via ADXN)

4740 15/2 0507-0521\* no Aida, but taps + bugle improvisation (Sandy Blaize, LA)

- 4760 (Cf Feb LN-9) Waynesboro stn most probably is WABO in MS on 990, but would require receiver calibration to be off (Frank J. Hermann, Ont.) Way off, as 5x 990 = 4950 (gh)
- 5110 What's this, hrd 16/1 from 0408 t/in to 0411\* with quick piano pieces, and at 0411 man saying "terminat, terminat, terminat" with excellent sigs and never hrd again? Well, we can rule out the Voice of the People of Burma (Richard Stoller, NY) How about Czech spy?
- 7260 unID time pips permeating this and SWF 7265, on from 0230. One-second intervals, and definitely not Morse code tomfoolery (Daniel Gallagher, TX, 10/2)
- 9623 between Canada and Belgrade; FR talk by man with light mx; chime/balafon-like IS 2157 to 2200 when ID and into nx; suspect Libreville in another move, ex-9577 (Dan Robinson, DC)
- 25075 Weak stn in RS with music hrd at 0640 10/12; PTP or harmonic? (Jack Searle, NZDXT) Very likely Vladivostok, 5 x 5015, a harmonizer from way back I've even heard on x 6 (gh)

## DX PROGRAMS

CANADA RCI DX Digest edition 2 now includes on the 2nd Sunday of the month a report from HAP-US; and on the 4th Sun, CHAP (Ian)

- GERMANY WEST et al. There is a weekly net of hams who work at the various DW xmtr sites, Sat at 0900 on  $\pm$  14300 kHz SSB. Everyone is invited to listen in (DW DX 11/2)
- HUNGARY R. Budapest DX pgms: 0400-0415 to Nam, in EG Wed/Sat; SP Tu/Fri on 17720/15225/11910/9585/6105/6000. 1400-1415 GM Sat on 21525/17785/15160/11910/9585/7200/5980. 1515-1530 to Eur in EG Tu/Fri, GM Wed, IT Mon/Thu 15160/11910/9585/7215/5980 (BBCMS 1/78)
- NETHERLANDS Beginning in March, RN DX Juke Box will have a series of talks explaining the strange sounds heard on SW (DXJB 27/1 via gh)
- PORTUGAL R. Portugal has gotten its DX pgm going again every two weeks, in combo with mbg pgm; DX items are supplied by the WDXC of England (Douglas Doull, NZ, SCDX 24/1)
- TURKEY (Cf Feb LN-11) It turns out there is a third DX Corner from VOT on Sats (Pickard, IL)

## PROGRAM NEWS

ALGERIA Check Algiers on 9685 around 0500-0520. On some days, there is a recital from the Koran (not "Arabic chanting" as some DXers have called it) by one of the best, Sheikh Abdul Bassat Abdul Sannad, who can hold his breath for over a minute (Moosa Sabadia, TX)

- BRAZIL R. Nacional Amazonia pgm on 11780 includes these PT pgms Mon-Sat: 1900-2100 Música Informação e Notícia, 2130-2200 Pergunte o que Quiser. Mon/Wed/Fri 2100-2130 Cantigas de Toda Gente, 2330-2350 De Tudo um Pouco. Tue/Thu/Sat 2100-2130 Viajando pelo Brasil, 2330-2350 Alfabeto Musical. Mon-Fri 2200-2330 Hora do Brasil e Projeto Minerva, 2350-2400 Noticiário. Sat 2200-2230 Alma das Coisas, 2230-2330 Revista da Semana, 2350-2400 Esporte. Sun 1900-2000 Parada Musical, 2000-2300 Futebol, 2300-2400 Clube do Ouvinte (via Sam Barto)
- BULGARIA R. Sofia weekly features: Tue, Bulgarian Economy, Among the People, Weekly Sports Round-Up; Wed, Life in Bulgaria, Across the Map of Bulgaria, alternating with Nature Almanac. Thu, The Socialist World of Today. Fri, Mosaic of Facts about Bulgaria, Midweek Mailbag. Sat, Weekly International Review, DX Programme, and From Friday to Friday--giving more details on these pgms. Sun, First broadcast, Topical Studio; Second broadcast, first week, R. Sofia's Disco Club; 2nd week, The Old Treasure Book, Folk Songs and Tunes of the Bulgarian Lands; 3rd week, Scanning the Pages; 4th week, Cultural Life Review. Mon, first broadcast, Answering Your Letters. Second broadcast, first week, Five O'Clock Chat. 2nd week, Spectrum; 3rd week, Youth Magazine; 4th week, Walks and Talks, Sights and Sounds, In and Around Sofia (via Sam Barto, CT)

FINLAND If you would like to follow R. Finland's Finnish-By-Radio course with free printed material, send them three address labels (R. Finland 29/1)

GUYANA GBS 3290 has some really weird programming! At 0830-0900 has "Voice of the Arabs" pgm mentioning "Palestine People Movement", Zimbabwe, etc., then after 0900 has GBS Morning Show with British terminology like "hire purchase terms" instead of "buy on credit". All this really threw me for a while; thought it was two different stations (Osterman, Ont.)

MALDIVES The R. Maldives OS on 4740 at 1500-1730 begins with 15 min of world news, and is followed, depending on the day, by such exotic programs as Oral Roberts, the Campmeeting Hour, the French Program, the USSR Program, the Czechoslovakia Program, Hour of Decision, the Italian Program, the Korean Programme, and Introductory Programme on the Republic of the Maldives, and various other gems! Sure wish I could hear it! (John J. Moritz, OH, February Review of International Broadcasting)

NORTH SOLOMONS R. NS on 3322½ heard at 1245 14/1 in Pidgin with some EG, in a phone-in talk show, "Your PNG Phone-in Station". All Pidgin except "Hello", "Thank you for calling", "Good Night Now" and many "Yes Sir"s and much laughter. I could not understand the content of the calls, so have written asking for more info. Civilization has surely come to Bougainville! (Syd Osterman, Ont.)

SA'UDI ARABIA BSKSA heard 24/1 2115-2145 on 11855 with a program of Irish music in the EG pgm; seems every Tuesday (Syd Osterman, Ont)

**SINGAPORE** R. Singapore's complete EG sked appears in FEDXR #17 (see PUBLICATIONS); there is a Programme Summary Mon-Fri at 0330, 0935, 1340; Sat 0615, 0935, 1340; Sun 0130, 0610, 0935, 1340 (gh)

**SURINAME** SRS after tip on gh's RCI DX Digest whipped into 4850 on 6/2 0228 to catch opening of EG pgm with luscious YL announcer!!! She sounds like Fawcett looks. Some US/Euro rock songs and this foxy announcer coming on between records with some pretty strange stuff--a must for the true DXers, hi!! (Bill Whitacre, MI) On 4885 22/1 (Blaise, IA)

**SWEDEN** The R. Sweden administration has proposed we reorganize our weekend EG programming. Mailbag would become a half hour program on Sundays, using musical requests. The review of the week would be put on Saturdays. The Saturday Show would cease to exist on SW (but would continue on MW). We need people writing in to defend The Saturday Show. Otherwise, there could very well not be any Saturday Show for you to hear in NAM. Write directly to The Saturday Show, Radio Sweden, S 105 10 Stockholm, Sweden (George Wood, Sweden)

**U K O G B A N I** Some of gh's BBC WS picks for March: India's Year of Change, 3 pgms the first 3 weeks, Suns 1830 & 2330, Wed 1430. Long Live the First Snowdrop about Christianity in the USSR, Good Friday 24th 1900, 25th 0030. The Intrusive State, Suns 0745, Mons 0315, 1715, 2315. Thirty Minute Theatre, Sats 0945, Mons 0230, 1345. Theme & Variations, Sats 1330, Mons 1830, Weds 0330. With Great Pleasure--poetry and prose, Sats 0030, Mons 0945, Tues 1330. On the African Alternative, Africa & Son, on the generation gap, Suns 0830, 1500, 1715. Vintage Comedy this month: Hancock's Half-Hour, Suns 1430, Tues 0330, Thurs 1030 (from London Calling)

**U S A** Some WYFR topics on "Conference Echoes", Suns 0200 on 6155: 12/3, "Submission: A Wife's Responsibility"; 30/4, "The Total Wickedness of Man". On "Open Forum", Sat 29/4 at 0305, "Why Did God Harden Pharaoh's Heart?" (gh)

**PUBLICATIONS** DX Listening Sometimes I'm the last to know of changes, but my column in the March Popular Electronics is supposed to deal with SSB Broadcasting; and in April, instead of May, on Non-English Broadcasts to NAM. Also check Communications Handbook 1978 for "Good Listening & Rare Catches" (gh)

USSR High Frequency Broadcast Newsletter, 4 orange pages monthly @ \$3 for 12 issues, gives excellent timely material on Soviet schedules and sites, including IFRB data seldom accessible to most DXers. Edited by Roger Legge, Box 232, McLean VA 22101 (gh)

DX Ontario, monthly pub of the Ontario DX Association, formerly restricted to Ontarians only, now may be subscribed to by other clubs, companies or organizations @ \$12/year (ANARC)

International Travel News has an SW column by Charles Signer. For a free copy mention ANARC to I.T.N., 2120 28th St., Sacramento CA 95818 (ANARC Newsletter Jan)

Far Eastern DX Review, published by JADX, CPO Box 1766, Tokyo 100-91, Japan. Sample copy by air worldwide for 5 IRCs. No. 17 is a 33-pager, including articles on a Leftist interruption of NHK TV news. Detailed freq & pgm skeds of regional USSR and many other Asian stations, spotlight on RRI Palembang; reprints of skeds from Korea, Singapore, TV Malaysia.

Stationen in Mittel- und Südamerika, 49-m-Band, is a free 8-page list provided as a service to DX organizations by the Austrian Radio Technical Dept. However, it is virtually useless. Compiled from official data, full of out-of-date or fallow registrations; shows hours of transmission for e.g. Mexican stations off the air for years; lacks station names; is replete with misspellings. What a pity! (gh)

Broadcasting in Canada is a book by F. S. Dallman; Routledge & Kegan-Paul, Boston, 1977 (gh)  
International Communications Bulletin, L. John Martin, Ed., College of Journalism, Univ. of MD, College Park, MD 20742. May be of some interest to DX listeners (gh)

Fourth Annual Report 1978 of the Board for International Broadcasting is a free 60-p booklet on the deep and dark mysteries surrounding the operation and management of RFE/RL. Includes the President's Report on International Broadcasting. BIB, Washington, DC 20005

NBS Time via Satellites, Publication TFS-602, 12-page booklet on GOES=Geostationary Operational Environmental Satellite, on 468.8250 & 468.8375 MHz. Order from NBS, Time & Frequency Services Section, Time & Freq Division, Boulder CO 80302 (Edelstein, NY, last two)

**GET WELL, GIB!** Gib Junqua, a really great guy and enthusiastic DX listener, who contributed frequently last year, has been quite ill and in the hospital for several months since Nov. 9. His friend Satoshi Wakisaka says he has lost feeling on the right side of his body and cannot write letters. He is getting well slowly, can walk with a stick and speak a little, his memory is returning and he reads the DX publications with great interest. Within one or two months he will leave the hospital and come back to his hobby. You can write to Gib thru Satoshi Wakisaka, "Yuzan-soh" No. 20, 11-15, Kasuga 1-chome, Ibaraki-city, Osaka, 567, Japan (gh)

IN MY OPINION

Sandy Blaize, LA: I couldn't agree with you more about the complementary character of SPEEDX and FRENDX! There is definitely room for both in our DX community. Although I am the new Technical Editor of SPEEDX, I intend to still try and support FRENDX as well with logging, suggestions, etc. No use to bicker over which one is the 'best'. I can't get by with just one! SPEEDX best for looking up a station by area, FRENDX best if you have a frequency you are trying to ID.

Syd Osterman, Ont.: I have been reading various letters and articles for and against the poor SWL. Mainly against, I think, and mostly by the so-called DX fraternity. Obviously we all have to start somewhere! Many cannot afford more than a 'cheap little portable'. Personally, I started during WWII in London, England, using 1-tubes, home built from junk, with a bed-spring antenna. I will never forget the thrill of hearing the US, Canada and many others on those simple receivers. They also provided a stepping-stone to an eventual career in the electronics industry. Of course, there were NO QSLs then either!

The point is that there is, or can be much more to the hobby than 200 VIC in the shortest possible time. Firstly, some knowledge of the theory of operation of the cheap, or expensive toys that one uses to listen with--oh, sorry, DX with! --cannot help but make you more proficient at knob twiddling. Secondly, one does not have to stay at the SWL level or become a dyed-in-the-wool DXer-QSL chaser. Surely, a third category, which may be called DX Listener would provide the optimum in both enjoyment and education. The idea is to acquire the ability to hear so-called DX stations and then endeavour to listen to them in depth, rather than just enough for a QSL. Local news bulletins in English are probably the most interesting and informative. Tapes can often be made from the likes of local PNGS and Solomons, etc. Without owning expensive DX receivers. Linguistic ability will, of course, increase greatly the number of DX stations "Listened" to.

I think that people in the hobby today are most fortunate to have clubs such as NASWA and bulletins like FRENDX. Getting the most out of the hobby is up to you!

Diane Lévesque, Box 2573, Carbondale IL 62901: I noted great improvement with the Feb FRENDX--the cover was really sharp! Maybe I'll start contributing again.

I heartily second your observations on SPEEDX. My main DX tool has been FRENDX because of the frequency listings as well as the crucial program detail that helps me ID a station when I'm just tuning around to see what's on (that's the most frequent method for DXing I use). But SPEEDX's log arrangement makes it invaluable for 'target shooting'--trying for a particular station or country--but it could use more of the crucial detail included so that one can be sure of what one hears. Each major DX club has its own feature that makes it invaluable to its members, like ASWLC's "Time Index" which lets you get an idea of what you can hear at a particular time; so all I can say is God forbid that all clubs started looking alike!!

Louis Goldstein touched on another sore spot concerning me & NASWA. The membership directory not making print for this year was not the last straw for me. The last straw was that I wasn't listed as a NASWA member last time, and now the chance to correct that situation has been removed!

By all means, print my address. By the way, what could possibly be the wrong hands? Terrorists with letter bombs? With all the weirdos who have written me already (such as the OM who lifted my name and address from a school book I sold four years ago ) I think I can take a few more, as I'm kinda off myself. If I was 'normal', I wouldn't be in this crazy, wonderful hobby in the first place, nicht wahr?

I was really pleased to see the articles on Radio Moscow and Radio 5, as well as the limericks. A breath of fresh air at last! There's hope for the ole gal yet . . .

Lawrence R. Edelstein, 56 Garden Lane, Centereach NY 11720: On Feb. 3, the first meeting of the Association of Suffolk DXers took place (ASDX). Tho our first meeting consisted of only 3 NASWans, we most definitely enjoyed ourselves. At last count, there were 7 NASWans in Suffolk County. Not exactly an overabundance. We met at Stan Olson's QTH (we being Larry Edelstein & Errol Urbelis) at 0100 and got acquainted with each other's interests and DX-experiences. Errol brought along part of his QSL collection (very impressive) and his log book (the most efficient one I've ever seen, and going back to 1958!). We had a go at Stan's spanking new FRG-7 and reeled in those Africans and Sams after 0400. We meet the first Friday of each month at a different location. All Suffolk or Nassau NASWans are welcome to attend. For more details, drop me a line. I'd especially like to hear from Francis Fumelli, George Heraghty, Paul Hoffman, and Fitzgerald Bramwell, all of Suffolk County

P.S.: The big mystery (to me) is: What does "C&E" stand for in your address?

gh: "Communications and University Extension"--now see why I abbr. it? Hi.

LAST MINUTE ITEMS

CANADA RCI M78 EG sked: 0615-0630 & 0645-0700 Mon-Fr  
9655/6140/D7155/6065/D11850. Sun 14-15 D6195/1295. D  
1545-1559 17820/15325/D11935/D9555/S15315/S11915. 1645-1659 17820/15325/D11935/D9555. 180  
-1829 & 1900-1929 17820/17760/15260. 1900-1929 15325/11855/D5995. 2000-2029 17820/17760/  
15325/11855/D5995. 2130-2159 17820/15325/15150/11945/9530. Mon-Fri 2257-0100 5960. 0100  
0127 11940/9535. 0200-0227 11845/9535. 0300-0327 11845/9605/9535/5960. 04-0427 9535/5960



• Editor: Myron Smith

36 Ogden Ctr. Rd., Spencerport, NY 14559

REPORTER/LOCATION	#	#	LOC	YR	RECVR	C/H	C/V	S/H	S/V	SOUTH AMERICA	
										C/H	C/V
1 James Young, Calif	3	25	HQ180A	222	207	860	284	15	13	L V Galapagos	6255
2 John Campbell, Austla	3	7	51S1	221	204	---	428	14	12	ZFY	5981
3 John Tuchscherer, Wisc	1	55	HQ180A	219	---	1122	---	---	---	L V Galapagos	6175
4 Irving Johnson, Calif	1	6	SFR4	218	70	---	---	14	2	FR3 Cayenne	3385
5 Sam Barto, Conn	3	13	-----	216	203	1351	916	15	14	HCKD5 R. Centro	3515
6 Richard Pistek, Ill	1	15	HQ180A	214	208	---	374	14	13	L V Galapagos	3510
7 Dan Henderson, MI	3	12	-----	213	200	---	---	14	14	Ecos Puerto Martinez	5568
8 Bob Padula, Austria	1	12	-----	212	205	---	---	13	11	R Encarnacion	11945
9 Marlin Field, Mich	1	17	SFR4	211	205	857	722	14	14	La Voz del Tigres	3255
10 Bill Sparks, Calif	1	22	R390A	211	205	---	662	14	14	R Encarnacion	11950
11 Al Sizer, Conn	1	9	SFR4	211	201	884	326	14	13	R Charitas	6110
12 Geoff Cosier, Austria	1	5	5R5DS	211	182	---	---	---	---	-----	-----
13* Edward Shaw, Ky	2	13	-----	210	199	783	458	13	13	Pto Martinez	5568
14 Ernie Behr, Ont	2	25	-----	210	186	1040	310	14	14	L V Galapagos	3520
15 Alan Mayer, Ill	1	17	SFR4	209	182	709	316	15	13	L V Galapagos	3520
16* David Potter, Fla	1	10	-----	207	---	780	---	14	---	-----	-----
17 Roger Legge, Va	4	44	51J4	204	177	---	744	14	14	PZH Surinam	6800
18 Paul Routenburg, Ont	2	5	SFR4	204	151	590	244	---	---	R Dimension	146 9650
19 Edward Kusalik, Ont	3	12	R338URR	203	169	351	278	13	10	R Demarara	3265
20 Dan Robinson, DC	4	8	SFR4	203	167	---	---	13	12	-----	-----
21 Myron Smith, NY	1	13	SX190	201	161	---	248	14	12	R Nec Paraguay	6025
22 Bill Whitacre, Mich	1	8	R4B	201	159	---	195	12	6	Cayenne	3385
23 Jerry Berg, Mass	3	19	SB310	200	192	---	---	14	14	AVROS Surinam	15405
24 Albert Garrou, Ill	3	11	-----	200	144	342	178	13	10	R Coro	4950
25* Al Niblack, Ind	-	-	-----	200	130	---	---	---	---	-----	-----
26 Victor Jaar, Que	2	13	R530	198	4	---	---	---	---	AVROS	-----
27 Alan Roth, NY	1	18	SFR4	197	181	610	465	14	13	AVROS	15227
28 Serge Neumann, Ind	4	14	HQ180A	193	170	---	201	---	---	-----	-----
29 Gerald Bishop, Pa	2	3	-----	191	133	477	202	14	12	R del Pacifico	4975
30 Larry Yamron, Pa	2	7	-----	190	149	---	---	---	---	-----	-----
31 Jim Fedor, Calif	2	2	FRG7	190	115	384	165	14	6	SRS Surinam	4780
32 Al Miller, Ohio	1	6	-----	188	167	466	214	13	11	R Guatapuri	4916
33 Larry Abraham, Mich	1	6	HQ180A	188	144	383	201	13	10	R Alvorada	3335
34 Neal Perdue, Ala	2	7	HA600A	188	55	---	---	---	---	-----	-----
35 Tom Gavaras, Minn	1	8	HQ180	185	144	309	222	13	11	L V Galapagos	3520
36 Joe Dileo, Conn	1	8	-----	179	153	522	349	13	12	R Pastaza	3315
37 Andy Robins, Mich	1	5	-----	179	124	---	---	13	10	-----	-----
38 John Fisher, Ont	1	7	-----	178	136	436	228	13	10	R Timbira	4975
39* Bob Vokes, Tex	2	3	-----	178	103	516	135	---	---	-----	-----
40 John Herkimer, NY	1	8	FRG7	175	151	---	---	13	12	L V Galapagos	4810
41 Charles Brunner, Pa	1	4	-----	174	85	---	---	13	5	L V Chile	9560
42 John Sgrulleta, NY	1	19	SFR4	173	173	---	---	---	---	R Nec Paraguay	6025
43 Mike Ryan, Calif	-	-	CRF320	172	153	---	---	---	---	L V Galapagos	3520
44 Hank Michalenka, RI	1	11	-----	172	136	293	154	13	12	L V Galapagos	3520
45 Chris Lobdell, Mass	1	13	FRG7	169	152	---	---	---	---	-----	-----
46 Charles Wootten, Turk	6	5	R530	168	139	424	306	10	9	L V del Huila	6150
47 Bobby Hobbs, NC	1	6	FRG7	168	96	262	153	8	4	R Quito	4923
48 Albert Cannon Jr, NC	1	8	HQ100	167	127	252	182	14	10	R Demerra	5980
49 Martin Poltz, Mich	1	6	51J2	167	111	330	137	13	10	R Andina	4995
50 Wade Smith, Mass	2	6	-----	164	95	---	---	---	---	-----	-----
51 Hadley Cress, Va	1	4	HR0500	162	6	---	---	13	---	-----	-----
52* Jim Zabransky, NJ	2	7	-----	160	148	---	---	12	12	R Aparecida	9635
53 Robert Wiles, W Va	1	3	XCR30	160	122	---	174	---	---	-----	-----
54 Richard Schwartz, Del	5	20	-----	160	121	---	---	---	---	Action R	3290

REPORTER/LOCATION	#	#	LOC	YR	RECVR	C/H	C/V	S/H	S/V	SOUTH AMERICA		
										C/H	C/V	BEST QSL/FREQUENCY
55 David Sarrazin, Colo	1	3	NC1B3D	160	87	239	99	13	6	FR3 Cayenne 3385		
56 Bob McCoy, Nebr	1	5	DX150B	160	81	352	94	14	8	R America 9505		
57 Jay Florian, Ill	4	4	-----	159	100	373	151	--	--	-----		
58 Ron Howard, Calif	2	7	SB310	158	132	---	---	13	11	R Demerara 5980		
59 Jerry Lineback, Ill	1	9	SFR4	158	94	308	117	--	--	-----		
60 Jerry Stuart, Okla	1	13	-----	156	125	224	216	16	12	R Rumbos 4970		
61 Kent Willis, Ky	1	1	-----	151	87	297	89	--	--	-----		
62 Jim Ronda, Ohio	1	5	-----	150	103	---	---	--	--	-----		
63 Terry Krueger, Fla	6	6	QR666	150	96	277	152	12	6	SODRE 15273		
64* Neal Kolb, Fla	-	-	-----	149	75	---	---	12	4	-----		
65 Robert Beaudoin, Conn	1	2	R388	148	108	---	126	--	8	R El Espectador 11835		
66* Brian Price, Ky	1	8	-----	148	78	320	95	13	8	Guyana Broad svc 3290		
67 Michael Agner, NJ	2	5	R4B	146	79	361	82	12	7	Ecos Puerto Martinez5568		
68* Jack Troy, Va	1	4	-----	145	37	---	---	--	--	-----		
69 Jim Uerlings, Ore	3	7	SFR4	145	11	310	11	11	1	-----		
70 Andre Pineault, Que	1	5	FRG7	144	102	217	120	10	8	FR3 Cayenne 3385		
71 Neil Wolfish, Ont	1	2	-----	144	100	295	153	--	--	-----		
72 Dan McCarthy, Fla	2	3	DX160	142	113	161	147	13	8	Guyana Broad Svc 3290		
73* Kerryn Brandt, NY	1	-	-----	142	92	---	---	--	--	-----		
74 Tom Overcamp, SC	2	5	SK600	139	110	---	---	13	8	La Cruz del Sur 4875		
75 Troy Gower, Ill	1	2	-----	139	104	146	110	--	--	-----		
76 Ira Teitelbaum, NJ	1	3	FRG7	137	132	336	281	12	11	L V Galapagos 4810		
77 Lauren Ware, Va	1	2	DX160	136	47	276	51	7	2	R Nac Brasilia 11780		
78* Joey Nonnast, Tex	-	-	-----	135	118	238	165	11	11	L V Galapagos 3520		
79* Henry Rockwood, Ohio	1	3	-----	135	108	---	140	13	10	LOL 15000		
80 Arthur Watson, BC	1	4	-----	135	74	275	91	12	7	R El Espectador 11835		
81 Robert Smith, Ill	1	1	-----	135	67	---	---	12	3	Ecos del Combeima 4875		
82* Bill Paschke, Wisc	1	9	-----	133	79	286	101	--	--	-----		
83* Mac Leonhardt, Ind	-	-	-----	133	70	---	---	--	--	-----		
84 Mitchell Taylor, Ga	2	2	DX160	133	66	189	76	13	5	FR3 Cayenne 3385		
85 Neil Schulman, NY	1	2	-----	132	83	224	95	--	--	-----		
86 Philip Wala, Mich	1	8	5900W	131	97	241	143	11	8	R El Espectador 11835		
87 Greg Ravenhorst, Minn	1	5	R4C	131	97	185	130	--	--	-----		
88 Allan Courtney, Ky	1	5	SK190	131	51	260	56	11	4	R Sutatenza 5075		
89 Scott Newman, Ill	1	5	RF5000	130	90	---	---	13	7	R El espectador 11835		
90* Woody Seymour Jr, NC	1	11	-----	129	105	---	---	--	--	-----		
91 Robert Fleck, Ill	2	11	SW4A	128	100	---	---	11	7	R Demerara 5980		
92 Charley Hoffman, Pa	1	3	FRG7	127	90	---	---	12	6	Esc Radio Fonicas 3985		
93 Mike Hardester, Okinawa2	9	SFR4	124	114	239	194	10	9	Fr Guyana 3385			
94 Edward Pyatt, Pa	5	14	XCR30	123	110	183	158	--	--	Action Radio 3290		
95 Adam Gaffin, Mass	1	5	SSR1	123	79	269	129	--	--	R Turismo 6180		
96 Henry Lazarus, La	1	10	SK100	122	112	359	294	13	12	R Cenit 4770		
97* Charles Foxx Jr, Va	-	-	-----	120	106	161	138	7	7	R Fides 4845		
98 Bill Bogel, Calif	2	2	FRG7	120	---	---	---	--	--	-----		
99 Brian Alexander, Pa	1	7	DX160	119	64	214	83	9	4	LOL 10000		
100 David Snyder, NY	1	4	-----	119	54	---	---	--	--	-----		
101 Jim Davis, Calif	-	4	-----	118	77	228	92	8	7	R Brasil Cent 4995		
102 Peter Schipelliti, Mass	2	FRG7	117	53	212	80	6	3	8	R Nac Brasilia 11780		
103 Larry Edelstein, NY	1	7	SFR4	116	27	---	---	10	2	R Argentina Ext 11710		
104 Werner Hoffman, Calif	1	2	-----	115	---	180	---	--	--	-----		
105 Dave Twiggs, Conn	1	2	-----	114	78	226	121	10	5	R Quito 4920		
106 Jeff Roth, Ohio	1	10	5900W	113	77	203	88	--	--	-----		
107* Graeme Brown, BC	1	1	-----	113	57	164	93	10	3	R Nac Brasilia 15445		
108* David Ball, Ont	1	5	-----	109	98	185	127	8	7	Guyana BC Svc 3290		
109 Gerald Word, Ga	1	12	FRG7	109	91	---	---	10	7	Action R 3290		
110 Steve Shotola, Ill	1	3	DX160	108	75	164	92	11	6	R Dif Taubate 4925		
111* Robert Koziomkowski, NY	-	-	-----	108	55	135	80	12	5	Brazil		
112 Dan Morisseau, Nebr	2	8	FRG7	104	38	191	50	10	2	R Nac Brasilia 11780		
113* Pat Tobin, Pa	1	3	-----	103	74	165	93	--	--	-----		
114 Robert Viau, Que	-	-	HR050T	101	82	---	106	7	6	R Nacional Peru 9550		
115* Keith Russell, Ill	2	4	-----	101	69	145	71	10	5	Guyana BC Svc 3290		
116 Mildred Marshall, ND	1	9	SK122	100	89	164	142	--	--	-----		
117 Bruce Lavery, Ga	1	1	-----	100	2	184	2	10	--	-----		
118 Gary Biasini, Alta	1	2	SFR4	99	48	---	---	9	2	R Brazil Central 4985		
119 Joe Delap, Ark	1	2	-----	98	45	177	60	--	--	-----		
120 Tom Blossom, Ohio	4	16	SFR4	97	84	---	---	6	5	R Nasional Brasil 15295		
121 Susan Wyllie, Mass	1	4	-----	97	79	146	118	8	6	R Clube Pernambuco 11865		
122* Paul Dumire, Mo	1	1	-----	97	53	148	63	--	--	-----		

REPORTER/LOCATION	# #		RECVR	C/H	C/V	S/H	S/V	SOUTH AMERICA	
	LOC	YR						C/H	C/V
123* Dick Heimke, Mich	-	-	----	96	68	---	---	---	-----
124 Ted Maszynski, Conn	1	3	RF2200	96	43	143	46	---	-----
125 William Mann, Ont	1	6	SK190	94	80	104	90	8	6
126 Kevin Mikell, Ill	1	2	XCR30	94	73	182	112	5	2
127 Timothy Noonan, Wisc	1	2	-----	94	66	180	93	6	5
128 Bill Reynolds, NY	1	9	SW4A	93	46	134	73	5	5
129 Charles George, Tex	1	5	SSR1	91	60	---	---	9	4
130 James Milvey, NY	1	3	-----	90	75	---	---	---	-----
131 Frank Hermann, Ont	2	3	DXL60	89	68	150	127	6	4
132 Pete Grenier, Calif	2	8	FRG7	88	66	117	77	9	6
133 Mike Brooker, Ont	5	5	TFM80	86	64	125	81	7	4
134 Michael Bolitho, Ont	1	1	-----	86	59	110	70	6	3
135* Larry Talbot, Wisc	1	5	-----	85	67	---	---	7	4
136 Jay Golden, Ill	-	-	-----	84	57	105	71	---	-----
137* Ciro Guarducci, BC	1	4	-----	82	73	169	112	---	-----
138 Tim Barany, Ill	1	2	5900W	82	63	---	---	---	-----
139 Dale Bohlke, Minn	1	1	FRG7	82	43	103	55	---	-----
140 Jackie Cole, Colo	1	6	SW4A	81	56	---	---	8	3
141 Albert Muick, Pa	1	4	Soundsn	80	78	170	149	---	-----
142 Mickey DeImage, Man	1	5	-----	79	74	112	96	---	-----
143 Robert Ward, NB	1	2	SK190	79	57	128	69	---	-----
144 John Sillings, NY	1	2	HA600A	77	59	113	82	7	4
145* Arnold Lausevich, Wisc	-	-	-----	77	56	---	---	---	-----
146* Richard Lucas Jr, NY	-	-	-----	77	53	---	---	8	5
147* Bruce Schoenfeld, Conn	1	3	-----	74	58	122	71	8	6
148 Chuck Self, Minn	1	2	DXL50A	74	58	109	75	---	-----
149 Anton Dubrick, Ill	1	2	-----	73	46	119	67	---	-----
150 Tony Capobianco, NY	4	4	SW4A	69	53	---	---	---	-----
151 Aaron Gadouas, Vt	1	2	-----	67	29	80	31	---	-----
152 Edward Stroh, Ill	1	2	SR4	66	52	75	60	6	2
153 Dave Valko, Pa	1	1	DXL60	66	51	80	51	---	-----
154 Roger Peterson, Conn	1	1	-----	64	57	68	60	---	-----
155 Daniel Conti Jr, NY	1	1	FRG7	64	45	73	51	---	-----
156* Larry Klassman, Ill	1	1	-----	61	50	76	61	---	-----
157 Martin Alintuch, Mass	1	1	-----	59	45	78	59	---	-----
158 Joe Dias, Calif	1	3	Astro8	59	45	75	56	---	-----
159 Ken DeLong, Pa	1	2	5900W	59	41	74	56	6	1
160* Wayne Grow, Pa	1	4	-----	58	20	75	20	---	-----
161 Joe Thut Jr, Pa	1	3	DXL60	55	47	62	55	6	4
162 Bob Schneek, Mo	1	1	-----	55	21	80	25	---	-----
163 Robert Zajda, Mass	1	2	DXL60	54	34	66	38	4	1
164 Thomas Kenny, NJ	1	3	DXL60	54	25	62	31	5	2
165 Tom Jeffrey, Ariz	-	-	HQ100A	52	21	---	---	3	2
166 James Matthew, Vt	3	4	FRG7	47	38	60	44	4	2
167 Dave Hascall, Ind	1	3	-----	47	20	56	29	6	1
168 Tom Lister, BC	1	1	DXL60	46	28	58	34	4	2
169 Robbie Berezowski, Alta	1	1	Patr19	46	27	58	24	---	-----
170* John Hathaway, Ill	1	12	-----	44	20	215	48	---	-----
171* Lexington Smith, NY	-	-	-----	40	20	---	---	---	-----
172 Mike Colacave, Mass	1	1	DXL60	33	25	---	---	---	-----
173* Bobby Dunnigan, NC	1	1	-----	33	13	42	16	---	-----
174* Peter Giacopelli, NY	1	1	-----	31	24	---	---	---	-----

\* next to your name indicates that you have not updated your totals in over a year. If I do not receive an update before the next Scoreboard is published I will drop your name.

TOP TEN COUNTRIES VERIFIED

- Richard Pistek 208
- James Young 207
- Bob Padula 205
  - Marlin Field 205
  - Bill Sparks 205
- John Campbell 204
- Sam Barto 203
- Al Sizer 201
- Dan Henderson 200
- Ed Shaw 199

TOP TEN SOUTH AMERICA

- | COUNTRIES HEARD    | COUNTRIES VERIFIED |
|--------------------|--------------------|
| 1. Jerry Stuart 16 | 1. Sam Barto 14    |
| 2. James Young 15  | Dan Henderson 14   |
| Sam Barto 15       | Marlin Field 14    |
| Alan Mayer 15      | Bill Sparks 14     |
| 17 tied at 14      | Ernie Behr 14      |
|                    | Roger Legge 14     |
|                    | 6 tied at 13       |

(Please turn to page 45)

# QSL REPORT

Sam Barto 245 Cherry Ave., Apt. J-11 Watertown, CT. 06795

Those follow-up reports that you send,  
will certainly pay off in the end.

- ADMINALITY ISLANDS:** Radio Manus 3905 f/d yellow map card & bumper sticker in 1 mo. for 2 IRC's. v/s Jack Anifuro(sp?), DX Officer. He stated that the NBC HQ will QSL all rpts to provincial stations. (Sarrazin)...Great QSL and some good news...Go to it gang.
- AFGHANISTAN:** Radio Afghanistan 15365 2 f/d cards in 53 & 42 ds. for 2 IRC's. (Gionet).
- ALBANIA:** Radio Peking (relay) 7120 "Circles" card & ltr in 18 ds. (Blossom).
- ALGERIA:** RTVA 9705 "Emblem" card w/o freq. in 14 weeks for EG report. (Sarrazin).
- ANTIGUA:** BBC 6195 f/d ltr in 25 ds. v/s James Metcalfe (Baysa). 11775 in 4 mo. via the World Radio Club DX Award (Gionet). 9545 card in 322 ds. (Ravenhorst). In 2 1/2 mo. (Fedor).
- ARGENTINA:** LRA Radio Nacional 6060 ltr in 29 ds. for a SP rpt and 2 IRC's. v/s A. Fereras, Rel. Publicas. Arrived via registered mail and my IRC's were returned. (Pineault).
- ARMENIA:** Radio Yerevan 9735 small white card w/ date and freq. & mint USSR stamps in 70ds.
- ASIATIC RUSSIA:** Radio Moscow via Khabarovsk 15100 for ECNA, Petropavlovsk- (Marshall). Kamchatsky 15210, Irkutsk 15420 for ECNA (Barto). Novosibirsk 11740 and Khabarovsk 7150 in 45 ds. (Kusalik). Petropavlovsk-Kamchatsky on 15140 and on 15450, Nikolayevsk-on-Amur on 12010, Khabarovsk on 12050 along w/ copy of Soviet Constitution. (Marshall). Petropavlovsk-Kamchatsky on 17720 in 38 ds. (McCarthy). Vladivostok 15130, Krasnoyarsk 11940, Nikolayevsk-on-Amur 9780 in 45 ds. (Wallace).
- AUSTRALIA:** VNG 4500 f/d card in 2 mo. for 2 IRC's (Hermann). ABC Perth 9610 f/d blue map card, sked in 19 ds. for 1 IRC (Baysa). 15425 in 2 1/2 mo. (Fedor). ABC Brisbane (Bald Hills) 4920 f/d card w/ site in 1 mo. (Kusalik) same in 12 ds. for 2 IRC's (Baysa). Radio Australia 9580 Shepparton f/d card in 169 ds. (McCants). same w/ pennant in 247 ds. (Byron). 17795 f/d "Mallee" card in 3 mo. via Shepparton and for 15320 via Shepparton w/ "Fringe Lily" card in 3 mo. (Kusalik). 15320 via Shepparton w/ "Parakeet" card in 126 ds. (Ponder). 5995 via Lyndhurst w/ "Pink Rose" card in 64ds. (Berezowski). 15410 via Lyndhurst w/ "Parakeet" card in 5 mo. (Baum). 11720 via Shepparton w/ "Lorikeets" card in 33 ds. (Byron). 15400 via Shepparton in 6 mo., 21570 via Carnarvon in 6 mo. (Wallace). 15320 and 17795 w/ "Lily" & "Parakeet" cards in 35 ds. (Mrowczynski). 17795 and on 9550 w/ f/d "Lorikeets" & "Pink Rose Cone" cards in 99 ds. (Burns). ABC via Lyndhurst on 9680 (VLH9) and via Brisbane on 9660 (VLQ9) cards in 59 and 22 ds. respectively for 1 IRC. (Wallace).
- AUSTRIA:** ORF 9770 "Studios" card and booklets in 42 ds. for 1 IRC. (Mrowczynski). f/d card & sked in 39 ds. (Byron). 6155 f/d "Centre" card, rpt forms, sked in 43 ds. for 1 IRC. (Blossom). "Phantasmagorical Landscape" card in 50 ds. for 2 IRC's (Zajda)...I give up.
- AZERBAIDZHAN SSR:** Radio Moscow via Baku 21495 card w/ site for EG service to Af. in 28 ds. (Barker). 21490 same service in 1 mo. (Barto).
- BANGLADESH:** Radio Bangla Desh 17990 f/d card in 6 mo. (Wallace). 15520 paper logo card in 80 ds. v/s Mohamed Khalilur Rahman, Research Engineer. "Radio Journal" and sked rcvd. (Onken).
- BELGIUM:** ORU 21460 in 48 ds. for FR rpt. (Viau). 21460, 17740, 15210 w/ "Modulateur" card in 3 weeks. (Barto). 6080 "Map" card in 6 weeks (Burke). same in 1 mo. (Barto). 11850 card, magazine and sked in 76 ds. (Byron). 6080 card, sticker, ltr, and magazine in 38 ds. (Sarrazin).
- BELIZE:** Radio Belize 3300 f/d card in 14 ds. for 2 IRC's (Word). 3285 card in 3 weeks for EG report (Barto).
- BENIN:** ORTB 4870 f/d "Beninoise Montage" card w/ beautiful stamps in 3 mo. for a FR report. My third try. (Hywarren).

Please try to use the QSL Column report forms provided by your editor. They are available for a SASE via my address....Thank you.

And now on to more great QSL's.

الإذاعة والتلفزيون الجزائرية

RADIOIFFUSION - TELEVISION ALGERIENNE



**Potencia 10.000 Watts**

**RADIO  
Panamericana  
LA PAZ BOLIVIA**

**OM.580 Kc.  
O.C. 6035 Kc.49 mts.  
F.M. 97 Mc.**

**QUESTION**

Would any contributors like to convert back to listing the State along with each reporters name? Let me know..Sam.

**BOLIVIA:** Radio Luiz de Fuentes 6206v

ltr. in 5 weeks for a SP report and used

stamps for a 1974 reception. v/s Manuel Villena

Carretero, Director-Gerente. Addr: Calle Ingavi 600,

Casilla de Correo 125, Tarija. (Barto). Radio Panamerica

6035 card and small pennant in 3 weeks for a SP report. Addr:

Cajon Postal 5263, La Paz. (Barto).

**BONAIRE:** Trans World Radio 11925 "Redemption" card, rel. info., sked,

in 18 ds. (Desrosiers). 11815 f/d "Studio at Night" card in 18 ds. for 2

IRC's (Baysa). Radio Nederland 6165 "DX Producers" card in 24 ds. (Vos). same

cards for 6165, 15310 and on 15180 in 1 mo. (Barto).

**BRASIL:** Radio Difusora do Amazonas 4805 postcard in 2 mo. for a PT report, tape and mint

stamps. Addr: C.P. 311, Manaus. v/s Jose Joaquim Marinho. (Lazarus). Radio Gaucha 11915

card in 30 ds. for a PT report. (Hoogerheide). Radio Nacional de Brasilia 11780 f/d

printed form and a ltr. in 130 ds. for an EG/PT rpt. Sked, tourist info., sticker was

also received. (Weber). same in 4 mo. w/ a white card. Addr: C.P. 04/0340 Brasilia, D.F.;

Call is ZYF263 per QSL (Barto).

Radio Bandeirantes 11925 card,

pennant and postcards in 5 mo.

for an EG report. (Tiers). same

in 5 weeks w/ color photos,

large white and orange pennant.

Addr: N. 13-Morumbi, C.P. 372,

Sao Paulo. (Lazarus).

**BULGARIA:** Radio Sofia 9700 f/d "Wind

MITI" card in 82 ds. (Byron).

"Nevsky Cathedral" card in 4 mo.

(Sarrazin). same in 105 ds. for 2 IRC's. Also received stamps, sked., and monitor forms

(Zajda). "Nessebur" card for 30.92 meters (Weber). 7115 card in 3 weeks. (Barto). 5915

"Cathedral" card in 55 ds. for 1 IRC. (Neff). 9700 card in 83 ds. w/ sked (Byron).

**BYELORUSSIAN SSR:** Radio Moscow via Minsk on 11745 in 40 ds. (Kusalik).

**CAMEROONS:** Radio Buea 3970 ltr. w/ date only in 2 mo. after a follow-up for 3 IRC's (Berg).

f/d form ltr. in 135 ds. Addr: Ministry of Information and Culture, Dept. of Broadcast-

ing, c/o Ngiewih Asunkwan, Le Chef de Station Buea. (DiLeo). Radio Garoua 5010 f/d ltr.

in 36 ds. for an EG report and 1 IRC. (Desrosiers). same in 105 ds. for

1 IRC. (Child). same in 30 ds. for 2 IRC's. v/s Jim Achanyi-Fontem.

(Word). same in 24 ds. w/ personal ltr. and a tourist magazine. (Over

camp). same in 30 ds. for an EG report and 4 IRC's. (Wiles).

Radio Bertoua 4750 f/d QSL in 68 ds. Addr: Ministry of Information

and Culture, c/o Jean Marie Etqundi, Le Chef de Station Bertoua.

(DiLeo)...Beautiful QSL Joe. Don't remember this one being rpt'ed.

**CANADA:** BBC via Sackville on 5990 in 4 mo. via World Radio Club Award.

(Gionet). CHNX 6130 card in 11 ds. (Mann). CFRX 6070 "Marine Mobile"

card in 30 ds. for 1 IRC. v/s C. Eastwood and D. Lumley (Desrosiers).

same in 11 ds. (Sarrazin). CKZU 6160 Vancouver, B.C. f/d "Broadcast Center" card in 9ds

v/s Francis H. Bucher. (Sarrazin). CFCX 6005 Caughnawaga, P.Q. "Studio" card in 31 ds.

for 1 IRC. (Desrosiers). RCI 17820 card in 74 ds. (Mayer). CHU 3330 "Fleming" card in 4

weeks (Blossom). same in 43 ds. for 1 IRC. (Zajda). 7335 in 39 ds. for 1 IRC (Desrosiers).

**CANARY ISLANDS:** RTVE 11880 f/d card in 38 ds. (Mann).



**RADIO NACIONAL  
BRASILIA - DF**

**TAKE NOTICE**

William Mann of Brantford, Ontario informs us that as of April first Canadian postage is to be increased to .14c per ounce.

TAKE NOTE



**SUPERESE  
CON..**

**LA VOZ  
DEL LLANO**

We must have a very interesting bulletin. This poor fella was so engrossed in reading it that he lost control...Sam.

SUPPORT  
NASWA  
ITS THE  
CLUB THAT  
SERVES YOU.

**CHAD:** RNT 4904.5 f/d card in 27 ds. for EG report and 2 IRCs

(Word). "Three Scenes" card in 1 mo. for ms(Berg). same in 1 mo. (Sarrazin). same in 23 ds. for FR rpt. (Mann).

**CHILE:** Emisora Diego Portales 9572 f/d ltr. in 17 ds. for a SP rpt and 1 IRC. v/s V. C. Gomez(Baysa).

**CHINA, PEOPLES REP:** Radio Peking 15060 magazine, calendars, usual stuff in 16 ds. Also sent lapel pin, scroll hanging, etc.(Byron). 11945 "Toy Giraffe" card in 17 ds. for 1 IRC.(Padgett).card and calendars in 1 mo.(Berezowski). 15060 "Radio Wave" card in 28 ds. and "Chinese Town" card for 15520 in 34 ds.(Leithner).

**COLOMBIA:** Radio Nacional de Colombia 15333, 13849, 11792

"Quinta de Bolivar" cards in 3 weeks. v/s Juan Climaco

Arbelaez, Director (Barto). Radio Bucaramanga 4845 card in 45 ds. for a SP rpt. and 1 IRC. Also received a window sticker(Word).

La Voz del Llano 6115 date only ltr. in 56 ds. for a SP rpt. and ms. (man).

v/s Jairo E. Cifuentes, Director Programs. A large bumper sticker was received.(Hoff-Nondas del Orteguaza 4975 personal ltr. in 2 mo. for a SP rpt. and ms. v/s Fred Emiro Nunez C., Director Gral., A very beautiful red, green, black and white pennant was also received from the station.(Lazarus).

**COSTA RICA:** TIFC 9645 f/d card in 4 mo. v/s Joe M. Viquez S., Received a gold-flecked pennant.(Sarrazin). same in 13 weeks. v/s Mary H. Steele (Bohlke). Radio Reloj 6006 f/d

"Aqui Costa Rica" card in 21 ds. (Wirsz). 4832 f/d "Volcano" card in 22 ds. (Sarrazin) CUBA: Radio Habana 11930 f/d card in 22 ds. and on 11725 w/ lapel pin in 86 ds.(Byron).

17885 card in 83 ds.(Byron).11930 "Logo" card in 87 ds. w/ usual stuff and pin(Weber).

**CYPRUS:** CBC 9770 f/d "Scenes" card in 1 mo.(Sarrazin).same in 5 weeks.(Fedor).

**CZECHOSLOVAKIA:** Radio Prague 9630 f/d "Lipno Dam" card in 4 mo. for 1 IRC.(Dawson). 5930 f/d "Piestany Therma Palace" card in 64 ds. for 1 IRC(Burns). "Tatra Mountains" card in 58 ds. for 1 IRC.(Zajda). 7345 "Lipno" card in 44 ds.(Fraser). f/d card and pin in 30 ds. (Byron)."Castle" card in 99 ds. (Ponder). (Baysa).

**DENMARK:** Radio Denmark 15165 f/d card w/ picture of antenna tower in 27 ds. for 1 IRC.

**DODECANESE ISLANDS (RHODES):** VOA Rhodes 6015 f/d "Stamps" card in 1 week(Sarrazin).

**DOMINICAN REP:** Voz de la Fuerzas Armadas 4825 ltr. and a large pennant in 35 ds. for 1 IRC (Viau). Radio Mil 4930 ltr. in 38 ds. for a SP report and 1 IRC. (Viau).

**ECUADOR:** Escuelas Radiofonicas Populares 3985

folder card in 48 ds. for a SP report and

ms, v/s Padre Ruben Veloz, Director.

(Hoffman). Radio Tropical 3340 ltr.

in 1 mo. for a SP report. v/s Augusto

Cedeno Estupinan, Administrador(Barto)

Radio El Mundo 4750 card in 3

weeks for a SP report. v/s Gab-

riel V. Jimenez, Gerente(Barto).

HCJB 15115 card in 40 ds.(Viau).

6095 "Studio" card in 32 ds. plus

pennant, poster, etc.(Burke).

11915 3 cards"Power Plant", "Ant-

enna Unit" and "Diesel" cards in 35 ds.(McKinney). f/d card in 1 mo. (Byron)."Control

Board" card in 29 ds.(Baum).same card in 27 ds. for 1 IRC.(Desrosiers)."Trade Mark"

card in 72 ds. (McKinney). 9560 "Studio" card in 1 mo.(Calderwood). "Control Board"

card in 22 ds.(Fraser). "Aerial" and "Tuning Team" cards in 72 and 65 ds. respectively

(McKinney)."Power Plant" card in 37 ds. w/ poster, literature for 2 IRC's(Mrowczynski).

**EGYPT:** Radio Cairo 9475 card in 101 ds. (Berezowski). f/d card in 99 ds. (Word). (Byron).

**ENGLAND:** VOA Woofferton 9760 f/d card w/ site in 1 week(Sarrazin). BBC n/d card in 58 ds.

**EUROPEAN RUSSIA:** Radio Moscow via Zhiguljovsk on 7100 in 42 ds.(McCarthy). via Moscow on

6010(Overcamp).7200 "Clock Tower" card in 36 ds.(Fraser).7390, 9680 and on 9530 for

GB6I Service(Barto).6010 in 1 mo.(Hermann).15360 in 45

ds. (Wallace). Armavir on 12055 in 46 ds. for Af.

Service(Kusalik). Tula on 17765 for the Af. Ser-

vice(Barto). Serpukhov on 11700 in 5 weeks

for the GB6I Service(Barto).Kazan on

17720 in 30 ds. for the FR Service.

(Barker). Zhigulevsk on 9780 in

45 ds. (Wallace).

#### HELP

Your QSL Editor would like to contact any NASWA member who may have copies of SCDX bulletins # 1415 and up to the present. They will be returned to the sender. Thank you...Sam.

QUITO - ECUADOR  
105.3 MHz FM  
4910 Kcs.  
20,000 WATTS DE POTENCIA  
LA PRINCIPAL EMISORA DEL PAIS  
Emisoras Gran Colombia  
LA VOZ DEPORTIVA DE LA CAPITAL  
30 AÑOS ANIVERSARIO 1974  
615 Kcs.



RADIO  
TROPICAL



H. C. 2 B. J  
1.220 K.  
GUAYAQUIL

P. O. Box 3311

H. C. 2 B. K.  
4.750 K.  
ECUADOR

(Mrowczynski). Radio Free Europe 7115 card w/ date and meter band in 17 ds. (Sarrazin). Sites for 7115 are Bibilis, FRG and Gloria, Port... Sam. 11885 blue and white card in 10 ds. for US stamps. (Lazarus). Deutschlandfunk 7285 "Munche" card in 2 mo. after a follow-up. (Berg).

FINLAND: Radio Finland 15260 "Flag" card in 3 mo. (Barto). 11755 card in 1 mo. (Sarrazin).

FRANCE: RFI 11965 f/d "Couleurs et Lumiere de France" card in 77 ds. for 1 IRC. (Fraser). 15425 card, sked., and pennant in 1 mo. (Seymour). 15200 card in 126 ds. (Ponder). 15130 "Hotel" card in 71 ds. (Berezowski). 11860 card in 79 ds. (Byron).

FRENCH GUIANA: FR3 3385 card in 18 ds. for a FR report (Sarrazin). same in 23 ds. along w/ 2 stickers (Pineault). same in 23 ds. (Johnson)...Your editor received a QSL Column report and a very friendly letter from Mr. Irv Johnson an 81 year old NASWA member from Bell, Calif. If Irv can find the time to report and support the bulletin, so can we all...Sam.

GALAPAGOS ISLANDS: La Voz de Galapagos 4810 "Local Animals" card in 2 years and 4 mo. for a SP report and ms. v/s Padre Raul Pinto, Director. (Lazarus)...Must of went by Turtle.

GEORGIAN SSR: Radio Moscow via Tbilisi on 9760 card in 1 mo. for GB&I Service (Cannon). same in 1 mo. (Barto). 7185 f/d card in 1 mo. for EG to Af. Service. (Barker). 11820 card in 45 ds. w/ sked (Kusalik). 17805 f/d CMEA card in 46 ds. for FR Service to Af. (Kusalik).

GERMAN DEMOCRATIC REP: RBI 15240 "Venceremos" card in 5 weeks. (Barto).

GHANA: GBC 4915 f/d card and sked in 38 ds. for 1 IRC. (Brooker). same in 133 ds. (Ponder). 3350 card in 3 mo. (Fedor). 6130 from Tema in 144 ds. for 3 IRC's (Vargo). same in 9 mo. (Schweikart).

GREECE: ERT 9760 f/d postcard in 24 ds. for 2 IRC's (Baysa). 7215 and 6140 f/d white card and sked in 6 weeks. (Barto). 11730 f/d card in 27 ds. (Byron).

GRENADA: Radio Grenada 15105 f/d green card in one month. (Barto).

GUAM: KTRW Trans World Radio 15155 card in 37 ds w/ sked (McCarthy). same f/d card in 35 ds. v/s D. Fisher (Ravenhorst). "Antenna" card in 29 ds. for ms. v/s D. L. Davis. (Brooker). 15175 "Palm-Sail" card in 1 mo. v/s A. G. Newell. (Sarrazin). same in 2 mo. for 2 IRC's (Hermann). same in 56 ds. (Tiers). 9640 f/d card in 47 ds. for 1 IRC. v/s Linda Horton. (Onken). two f/d cards for an SASE in 21 ds. v/s Teresa Jones. (Kusalik)...Either the KTRW verification signers take turns or we hit them at their change of shifts...Sam.

GUATEMALA: TGNA 3300 "Quetzal" bird card in 2 weeks (Padgett). same in 2 1/2 mo. (Tiers). same in 22 ds. for 2 IRC's. v/s Wayne Berger, Chief Engineer. Transmitter site listed as Petapa Radio Miramundo (The Voice of the Army) 6158 "Clock of Flowers" colored postcard in 2 mo. for a SP report. v/s Carlos Ruiz Guevara, Radio Engineer. (Sizer).

GUINEA-BISSAU: Radio Nacional 5041 green card in 1 mo. for 1 IRC. v/s Tiburcie Ribeiro da Moura. I had reported the reception on 4780 but the QSL read 5041

HAITI: Radio Station 4VEH 11835 (Seymour). f/d "DJ" card in 140 ds. for 1 IRC. v/s Mrs. Edna Beachy, QSL Secretary. (Fraser) same in 67 ds. (Baldwin).

HAWAII: WVVH 15000 "Aloha" card in 16 ds. v/s C. L. Trembath, Chief Engineer (Zajda)

HUNGARY: Radio Budapest 6105 card in 31 ds. for 1 IRC. (Neff). 9585 "Bridge" card in 74 ds. and nx/paper (Fraser). 11910 f/d card in 26 ds. (Byron). 6160 card, sked., and nx/paper in 41 ds. Also sent a 10 filler coin in exchange for a Canadian penny. (Berezowski)...I think you got the better part of the deal...Sam.

ECUADOR: HCJB 9560 "Control Board" card in 35 ds. w/ sked. (Padgett).

ESTONIAN SSR: Radio Moscow via Tallin on 6055 w/ f/d card in 42 ds. for a FR report. (Gionet). Radio Tallin 6085 f/d "Turisalu Cliff" card and pennant in 152 ds. for an EG report (Gionet).

FEDERAL REP. OF GERMANY: Radio Deutsche Welle 5960 "Bullseye" card in 3 mo. for 1 IRC. Also pennant and tourist book (Dawson). 6010 n/d card in 6 mo. (Berezowski). 6075 card in 19 ds. for 1 IRC and ms (Neff). 6010 "Circles" card in 118 ds. (McKinney). 9765 f/d card, sked., and booklet in 103 ds.



RADIO



GHANA

RADIODIFFUSION TÉLÉVISION GABONAISE  
LABREVILLES

LA VOIX DE LA  
RENOVATION



**INDIA:** AIR Bombay 15080 f/d ltr. In 3 mo. for ms. v/s Asst. Station Engineer. QSL came direct from Bombay. (Berg). AIR Delhi 11775 "Beach" card in 134 ds. for 3 IRC's. (Vargo) "Street Scene" card in 87 ds. for 1 IRC. v/s Golsind Bedi.

**IRAQ:** Radio Baghdad 9745 (Weber) "Map" card in 33 ds. along w/ Eagle decal (Berezowski). same in 2 mo. for a FR report and 1 IRC. (Hermann).

**ISREAL:** IBA 17815 "Western Wall" card in 1 mo. (Barto). 9815 f/d card in 37 ds. (Kusalik). 17815 and 9815 in 46 ds. (Fraser) 9815 f/d card in 71 ds. w/ sked & report forms. (Burke). 11655 card in 2 mo. (Berezowski). 5882 card in 27 ds. (Viau). 15485 f/d card in 50 ds. (Wallace).

**ITALY:** RAI 11810 card in 7 1/2 mo. (Berezowski). 9575 "Amore" card in 57 ds. (Ponder). 9575 "Rit-ratto di Bambino" card in 70 ds. for 2 IRC's. (Zajda). 11810 same card in 232 ds. (Byron) 9575 "Vaprio Sull'Adda" card in 6 weeks w/ sked (Burke). 11810 "Il Pescatore" card in 180 ds. (Burns). 11810 f/d card in 218 ds. (Berezowski).

**IVORY COAST:** Radio Ivory Coast International 11920 f/d "SWL" card in 25 ds. My two previous reports went ignored. Please with this one. (Overcamp)... And well you should be... Sam. Radio Abidjan 4940 card in 43 ds. for 1 IRC (Baysa).



REMEMBER ONLY YOU CAN MAKE THIS QSL COLUMN THE BEST ONE GOING. KEEP THOSE REPORTS COMING IN.

SUPPORT NASWA ITS THE FINEST DX CLUB IN THE WORLD.

**EMISSORA CATOLICA DE MOÇAMBIQUE**  
 G. K. RA CR. RB  
 Telefone 2763  
**BEIRA**  
 Avenida General Humberto

**RADIO**

Frequencies

3.960 kc s	90 mc s FM
1.295 kc s	95 mc s FM

P. O. BOX 594

**PAK**

BEIRA - P. E. A.

**JAPAN:** Radio Japan 15105 "Fireworks" card and sked. in 16 ds. for 2 IRC's (Mrowczynski). same in 19 ds. for used stamps (Pappas). 9605 same in 19 ds. (Berezowski). 15270 f/d card, nx/letter, sked in 3 weeks. (Blossom). 9585 "Pagoda and Lake Sarusawa" card in 45 ds. (Lobdell). 15270 same in 18 ds. (Fraser). 5990 same card in 26 ds. w/ usual materials. via Yamata (Hoffman). Far Eastern Network 3910 card in 80 ds. (Kusalik).

**KAZAKH SSR:** Radio Moscow via Alma Ata on 15210 CMEA card in 45 ds. w/ XMAS card (Kusalik).  
**KENYA:** Voice of Kenya 4915 f/d aerogramme in 26 ds. v/s Rashid Bakuli. (Sarrazin). 4804 f/d ltr in 40 ds. w/ same v/s (DLeo).

**KIRGHIZ SSR:** Radio Moscow via Frunze on 17745 f/d card in 1 mo. for Af. Service. (Barker).

**KUWAIT:** Radio Kuwait 6055 card in 5 weeks (Barto). 12085 f/d folder card in 3 mo. for 1 IRC. (Viau). same in 90 ds. (Tiers). same card w/ sked in 2 mo. (Sarrazin). 9650 at Magwa and 11940, 12085 and 21685 at Sulabiya in 5 weeks. (Barto).

**LATVIAN SSR:** Radio Moscow via Riga on 15220 f/d card w/ site in 45 ds. (Kusalik).

**LIBERIA:** ELWA 11945 "Drummer" card in 7 mo. for 1 IRC. (Schwelkart) VOA Monrovia 12010 "Stamps" card in 1 week. (Sandborn). card in 8 ds. (Baysa).

**LITHUANIAN SSR:** Radio Vilnius 9720 f/d card in 6 weeks (Barker). 11770 "Birds in Tree" card in 187 ds. (Weber).

**LUXEMBOURG:** Radio Luxembourg 6090 f/d "Transmitter Towers" card in 21 ds. (Berezowski). "Coat of Arms" card in 36 ds. (Pappas).

**ELWA**



**MALAGASY REP:** Radio Nederland 11730 "DX Producers" card in 34 ds. (Pappas). 11740 and 11735 same cards in 7 weeks (Barto). 15220 same in 1 mo. (Berezowski). 11725 f/d card in 123 ds. (Ponder) 15375 card in 13 ds. (Vos). (Gionet)

**MALAYSIA:** BBC 11750 DX Award certificate in 4 mo.

**MALTA:** Deutsche Welle card in 3 weeks (Baysa).  
Radio Mediterran 6080 f/d ltr. in 316 ds. for 2 IRC's. v/s Victor Aquilina, Head of Radio Programs. Tourist brochure was also rcvd. (Zajda)

**MEXICO:** Radio Universidad de Sonora 6115 "School Seal" card in 15 ds. for EG report (Sarrazin).  
Radio Huayacocotla 2390 very nice white card in 12 ds. for a SP report. v/s Jorge V. Villalobos Grzybowicz, Coordinador. (Barto).

**MONACO:** Trans World Radio 6195 green and white "World" map card in 13 weeks. (Schweikart).

**MONGOLIA:** Radio Ulan Bator 6380 f/d card, post-cards, pennant and New Years card in 54 ds. for an EG report and a 1 yen coin. (Wallace).

**MOROCCO:** RTVM 15360 card in 25 ds. for 1 IRC (Viau).

**NETHERLANDS:** Radio Netherland 9715 Lopik "Staff" card in 3 weeks (Baysa). same in 46 ds. (Byron). in 16 ds. (Padgett). 6020 Lopik same card in 12 ds. for 1 IRC. (Fraser). same in 1 mo. (Burke). 15220 same in 17 ds. for 1 IRC. (Sarrazin). 11955 in 3 weeks (Barto). 15325 and 15220 in 7 weeks (Barto). 17810 "Costumes" card in 25 ds. (Desrosiers). FREE RADIO BROADCASTING CO. 6214.5 after Initial report in Dutch and a follow-up in EG, received what I believe to be the first QSL in NA for this station. (Robinson)...Great QSL. I guess that you, Pitt McNeil and I all logged this station on 1/1.

I'm still waiting for my QSL but you had the address before me. HI. Only heard this station twice since 1/1. One time at an all-nighter with the gang...Great QSL...Sam.

**NEW BRITAIN:** Radio East New Britain 3385 f/d card in 2 mo. (Sarrazin). same in 142 ds. for ms. (Kusalik). same in 6 1/2 mo. (Vernetti). same in 298 ds. (Gionet).

**NEW CALEDONIA:** FR3 7170 orange and blue card in 191 ds. for a FR report and 2 IRC's. (Pineault). same in 19 ds. for EG report and 1 IRC. (Sarrazin).

**NEWFOUNDLAND:** CK2N 6160 f/d card in 2 weeks. v/s F. Holm, Engineer (Pineault). "Symbols" card in 17 ds. (Desrosiers). same in 12 ds. (Baysa). CBC card in 25 ds. for a stamp (Mann).

**NEW ZEALAND:** Radio New Zealand 11780 f/d "Harbor" card in 2 weeks for 2 IRC's. Also received a pennant (Baysa). "Cable Car" card, ltr. & sked in 30 ds. for 2 IRC's (Burns). 6105 "Fishing" card and 11820 "Cable Car" card w/ pennant and Kiwi pin in 20 ds. for 2 IRC's (Blossom). 11820 in 25 ds. for 1 IRC (Viau). 15130 "Hot Springs" card in 83 ds. for 1 IRC and pennant (Dawson). 17710 card, sked and pennant in 23 ds. for ms (Kusalik).

**NICARAGUA:** Radio Nacional 5945 ltr. in 50 ds. for a SP report and 2 IRC's. Letter say to look for them also on 11875 (Mann).

**NIGERIA:** Voice of Nigeria

7275 f/d card for 2 IRCs (Barker). same in 41 ds. (Neff). in 55 ds. (Tiers).

NBC Sogunle 4990 f/d ltr. in 6 mo. (Bares). same in 39 ds. (Wallace). NBC Lagos 15120 f/d card in 38 ds. for 2 IRC's. (Baum).

**NORTH SOLOMONS** (Bougainville)

Radio North Solomons 3322.5 f/d ltr. in 52 ds. v/s Aloysius Sahoto, Station Mgr. (Kusalik).

**NORWAY:** Radio Norway 15175

"Elves" card in 41 ds. for 1 IRC. (Neff). "Frogneseteran" card in 2 weeks. (Fraser).

**PAKISTAN:** Radio Pakistan card

in 2 1/2 mo. (Viau).

REPUBLIKA MALAGASY  
MADAGASCAR



SPECIAL NOTICE

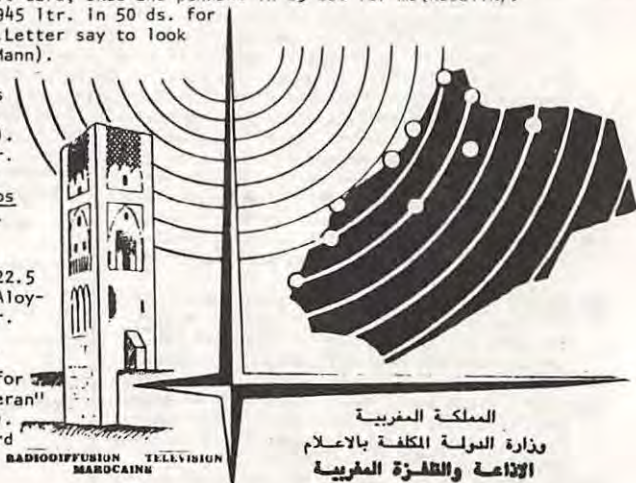

RADIOIFFUSION TELEVISION  
MAROCAINE

# Radio Television Kaduna



**PAPUA NEW GUINEA:** NBC 4890 3 f/d "Map" cards and a pennant for 3 reports in 25 ds.

(Baysa). same in 118 ds. (no name) same in 56 ds. for 2 IRC's (Viau). f/d "Map" card in 21 ds. (Swanson).  
**Radio Southern Highlands** 3275 personal ltr. in 27 ds. for ms. v/s Andrew Meles, Acting Station Mgr. (Kusalik). NBC 9520 Port Moresby f/d card in 176 ds. w/ sticker, pennant (Berezowski).

**PHILIPPINES:** Radio Veritas 9590 f/d card in 37 ds. for 3 IRC's. v/s Larissa V. Paner, Relations Officer (Vargo). 11955 f/d card, pennant, booklets in 40 ds. (Kusalik). "Manila Cathedral" card in 27 ds. for 1 IRC (Gionet). "Roxas Boulevard" card in 1 mo. (Berg). FEBC 17810 card in 29 ds. for 1 IRC (Viau). (Burke).

**POLAND:** Radio Poland 9675 "Heraldic Arms" card in 58 ds. for 2 IRC's.

**PORTUGAL:** RCI via RTE Sines 7285 RCI card in 1 mo. Also sent me 3 Aussie IRC's (Overcamp).  
**Radio Portugal** 11935 "Aquarium" card in 19 ds. (Burke). 11878 ltr. and f/d card for USB transmission in 3 weeks. Transmitter at Pegoes. v/s Ilda Duarte, Head of Public Relations. (Barto). Adventist World Radio 9670 Sines f/d card in 39 ds. for 3 IRC's (Hermann). IBRA Radio 9670 card and pennant in 1 mo. for 2 IRC's (Hermann).

**QATAR:** Qatar Broadcasting Service 9570 personal ltr. in 2 weeks. v/s A. R. Al-Madhadi, Director of Broadcasting (Kusalik). "Ras Usherl Palace" card in 41 ds. (Mayer). same in 3 weeks for NASWA FR report form. (Sarrazin).

**RHODESIA:** RBC 3396 large "Map" card in 25 ds. v/s B. O'Brien. (Blossom). same in 32 ds. for 1 IRC. (Desrosiers). 4828 Gwelo in 1 mo. (Barto). (Wallace).

**ROMANIA:** Radio Bucharest 15250 f/d card in 62 ds.

**RWANDA:** Deutsche Welle 9735 card, literature and a pennant in 3 mo. for a report direct to Kigali. (Hywarren). 7225 card in 35 ds. (Sarrazin). card in 2 mo. (Barker). Station will issue cards till the Kigali cards run out. (Wallace).

**SABAH:** Radio Malaysia 4970 f/d card in 56 ds. for 1 IRC.

**SAUDI ARABIA:** BSKSA 11855 f/d card, sked and ltr. via registered mail in 39 ds. v/s A. M. Babbain. (Pappas).

**SENEGAL:** Radio Senegal 4890 card in 91 ds. for 2 IRC's (Word).

**SEYCHELLES:** FEBA 11800 "Global" card in 1 mo. for 3 IRC's. v/s

Liz Scott (Lazarus). same in 3 weeks for 2 IRC's (Barker). 9770 f/d card in 1 mo. for 3 IRC's (Hermann). 11845 in 1 mo. (Tiers).

**SICILY:** RAI via Caltanissetta 7175 f/d "Painting" card w/ site in 99 ds. for a FR report (Gionet).

**SINGAPORE:** Radio Singapore 5052 f/d "Singapore at Night" card in 68 ds.

(Berezowski). same in 3 weeks (Sarrazin). same in 18 ds. for 1 IRC. (Wallace). 6155 f/d card in 1 mo. (Barto).

**SOLOMONS:** SIBS 5020 card in 3 1/2 mo. for 2 IRC's (Schweikart). same in 137 ds.

for 1 IRC. (McCarthy). in 141 ds. (Blossom). in 1 mo. (Tiers). in 119 ds.

**SOMALIA:** Radio Mogadishu 9585 "Tower" card in 1 mo. for 1 IRC. (Gionet).

(Seymour). same f/d card in 82 ds. for 1 IRC. (Onken).

**SOUTH AFRICA:** Springbok Radio 4810 Meyerton f/d card in 35 ds. (Berezowski). in

64 ds. (Baysa). "Industries" card in 16 ds. (Seymour). SABC 4810 card, booklet

and stamps in 31 ds. (Pappas). same in 32 ds w/ sked (Blossom). Radio Five 3388

f/d "Industrial" card in 50 ds. v/s P. V. D. M. Martins (Mayer). same in 3 mo.

(Bares). Radio RSA 11900 "Zebra" card in 3 weeks (Padgett). "Protea Cyanaroides"

card in 22 ds. (Byron). "African Evening" card in 18 ds. (Baysa). 21535 card in 20 ds.

for 1 IRC. (Padgett). 9585 "Zebra" card in 19 ds. for 1 IRC. (Padgett). 15155 "African

Sunset" card and a pennant in 43 ds. for 1 IRC. (Byron). 15155 and 9585 "Statuesque

Stripes" and "Zebra" cards in 1 mo. (Burns).

**SOUTH KOREA:** Radio Korea 11860 "Stamp" card in 2

mo. (Bares). XMAS & New Years cards (Verneti).

**SPAIN:** RTVE 9505 card and sked in 33 ds. (Fedor).

11880 f/d ltr. in 25 ds. (Swanson). 6065 f/d

ltr. in 30 ds. (Burke).

**SRI LANKA:** VOA Colombo 11745 "Stamps" card in 5

ds. (Seymour). "Industries" card in 16 ds. (Seymour). SABC 4810 card, booklet

and attractive "AWR QSL Certificate" v/s Adrian Petersen, Director.

Addr: ANR, Box 15, Poona 411001, India. (Berg).

**SWAZILAND:** Trans World Radio 17745 f/d "Warrior"

card in 21 ds. for 1 IRC. v/s J. Olson (Des-

rosiers). Swazi Commercial Radio 4980 "Warrior"

card in 2 mo. for ms. (Kusalik).

**SWEDEN:** Radio Sweden 6065, 11780 and 9630 "Map"

cards in 5 weeks. (Barto).

**POLSKIE RADIO-TV  
WARSZAWA**



**QATAR BROADCAST** V.L.E

Post Box 1414, Doha. 4.12.1977

Dear Mr. Sarrazin

We are glad to confirm your reception report of 9570 KHz

Dated: 16.11.1977

With regard,

*[Signature]*  
Director



Уважаемый Russel Barto!

Это подтверждение Вашего сообщения о том, что Вы слушали передачу Московского радио по "Розука"

This verifies your report on the reception of Radio Moscow's broadcast on  
"/s "Radio"

Дата 4 10 77.  
 Date \_\_\_\_\_  
 Время 20.00 - 20.14.  
 Time \_\_\_\_\_  
 Частота 31 м.  
 Frequency \_\_\_\_\_

РАДИОСТАНЦИИ «РОДИНА»

**SWEDEN:** Swedish Telecommunications Administration 21555 Varberg f/d map card in 3 weeks for their USB transmission. Addr: Radio Dept., B/Cing Division, S-123 86 Farsta, Sweden(Barto).

**SWITZERLAND:** SBC 6045n/d card in 59 ds. (Ponder). same in 20 ds. for 1 IRC (Padgett). 15140 f/d "Buildings" card in 56 ds. (Fraser). 3985 and 9535 via Lenk and 6165 via Sarnen, also 15305, 9560, 11775 and on 21585 cards w/ sites in 6 weeks. (Barto). ICRC Red Cross Radio 7210 "Earphones on Globe" card in 2 mo. for 1 IRC. (Schweikart).

**TAHITI:** FR3 11825 new "Mermaid" card in 3 weeks for 1 IRC. (Seymour).

**TAIWAN:** Central Broadcasting System 11905 beautiful, large blue card w/ gold inlay in 3 wks for 3 IRC's. v/s Chen Mei-sheng, Deputy Director (Berg). Voice of Free China 17890 f/d "Snow Geese" card in 52 ds. (Ponder). In 38 ds. (Fedor). 15425 f/d card in 57 ds. w/ tie pin (Berezowski). 15425 "Wei Shengs Grape Myrtle" card in 48 ds. w/ sked. (McCarthy).

**TANGIER:** VOA Tangier 9745 f/d "Stamps" card in 9 ds. (Fraser). to all of us... Sam.

**TANZANIA:** Radio Tanzania 9750 card w/ wrong freq., date, etc. in 3 mo. (Sarrazin). It happens

**THAILAND:** Radio Thailand 11905 f/d card in 3 1/2 mo. for 1 IRC. v/s Ramyong Sekonyran (Bohlke).

**TOGO:** Radio Lama Kara 3223 f/d "Emblem" card in 71 ds. for a FR report and 2 IRC's (Mayer). Radio Togo 5047 "Map/Globe" card in 1 mo. (Sarrazin). same in 62 ds. for 1 IRC. (Pappas). same f/d card in 26 ds. for ms. (Overcamp).

**TUNISIA:** Radio Tunis 7275 f/d card in 30 ds. (Mann). 15225 f/d "Terrasse du Palais d'Orient" card in 1 mo. (Sarrazin).

**TURKEY:** Voice of Turkey 9515 f/d card in 60 ds. (McKinney). "Ideal Matbaasi" card and pennant in 37 ds. for 1 IRC. (Byron). "Mosque" card in 48 ds. and pennant, sked (Berezowski). card and flag in 53 ds. (Weinhold). same in 38 ds. for 1 IRC (Desrosiers). 7175 card in 26 ds. (Fedor). 7175 "Mosque" card in 39 ds. for 1 IRC & ms. Also pennant & sked (Neff).

**UGANDA:** UBS 9730 n/d form ltr. in 158 ds. for ms. v/s C. Warugaba. (Kusalik). same in 41 ds. v/s David R. Buga, Asst. Controller for Programming. (Desrosiers).

**UKRANIAN SSR:** Radio Moscow via Vinnitsa on 17885 in 60 ds. for the Af. Service (Desrosiers). same via Simferopol on 17885 (Barto). 7300 Lvov in 42 ds. for the Af. Service (Sarrazin). 11950 and 11970 via Kharkov (Kusalik). 6170 and 5940 via Vinnitsa (Weber, Hermann, Desrosiers, Overcamp). 7135 via Simferopol (Barker, Overcamp). 7160 via Kiev and 7170 via Starobelsk for ECNA (Barto). Radio Kiev 5980 in 2 mo. (Hermann).

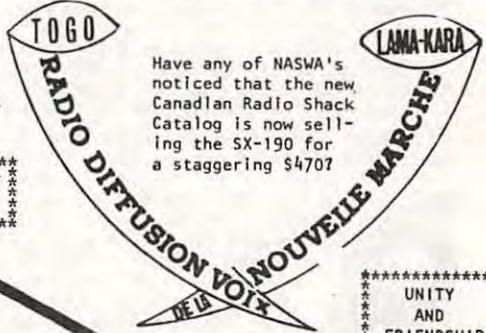

\*\*\*\*\*  
 \* SUPPORT \*  
 \* NASWA \*  
 \* \*\*\*\*\* \*

\*\*\*\*\*  
 \* UNITY \*  
 \* AND \*  
 \* FRIENDSHIP \*  
 \* \*\*\*\*\* \*

Report forms (5) are available from your editor for a .13c SASE.



- UPPER VOLTA:** Rdf. TV Voltaique 4815 f/d form ltr. in 4 1/2 mo. for a FR report and 2 IRC's. (Cannon). same in 2 mo. for a FR report and 1 IRC. (Sarrazin).
- URUGUAY:** Radio El Espectador 11835 f/d card via registered mail in 1 mo. (Tiers).
- USSR:** Radio Station Peace and Progress 11840 in 1 1/2 mo. (Schweikart). 7390 in 35 ds. (Ponder). 11970 "Buildings" card in 1 mo. (Cannon). 15385 in 4 mo. (Barto). Radiostantsiya Rodina 15455 f/d "Ukraine" card & sked in 63 ds. (Ponder). 9735 in 5 weeks for RS Service (Barto)
- USA:** United Nations Radio 15410 "Emblem" card in 6 mo. (Boh lke). WWV 5000 "Indian Chief" card in 60 ds. (Zajda). WINB 15270 f/d card in 15 ds for US postage (Pappas). 11775 red and black card in 17 ds. for 1 IRC (Baysa). AFRTS Bethany 9755 regular card in 1 week (Schweikart). WYFR 15130 Okeechobee, FL. "Logo" card in 25 ds. for 1 IRC. (Desrosiers). 6060 in 14 ds. (Baysa). 17845 "Skyscrapers" card in 14 ds. (Desrosiers). 9630 "World Map" card in 10 ds. (Cannon). 11780 in 8 ds. (Barto). 15130 in 20 ds. (Mayer). 11780 "Map" card in 19 ds. (Ravenhorst). 15130 in 20 ds. (Mayer). 15130 in 2 weeks (Overcamp). KGEI 5980 "San Francisco" card in 35 ds. (Pappas). in 25 ds. (McCants).
- UZBEK SSR:** Radio Tashkent 6025 card and sked in 35 ds. (Berzowski). 5975, 9540, 9600 and 6025 f/d "Statue" card in 5 weeks. (Barto). same card for 9600 in 42 ds. (Onken). 9600 "Lenin" card in 40 ds. (McCullough).
- VATICAN:** Radio Vatican 21485 in 2 mo. (Barto). 5995 "Stato Citta del Vaticano" card in 26 ds. for 1 IRC. (Baum). 11845 same card in 15 ds. (Byron). 5995 "Transmitter" card in 25 ds. for 1 IRC. (Padgett).
- VENEZUELA:** Radio Nacional 15400 "Castillo de Santa Rosa" card in 6 weeks for a SP report & used stamps (Barto). same w/ "Black Lake" card in 31 ds. for EG report and 1 IRC. (Burns) Radio Juventud 4900 "Jitterbug" card in 49 ds. for EG report and 1 IRC. (Desrosiers). card in 47 ds. for SP report and 1 IRC (Viau). Radio Barquisimeto 4990 "Globe and Tower" card in 74 ds. for a SP report and ms. (Hoffman).
- VIETNAM:** Voice of Vietnam 10040 f/d paper logo card in 140 ds. for 1 IRC. w/ pennant.
- WEST BERLIN:** RIAS 6005 "RIAS Building" card in 100 ds. (Cannon).
- WEST IRIAN:** RRI Sorong 4875 f/d card in 62 ds. for 1 IRC. (Wallace).
- YEMEN REP:** Radio Sanaa 9780 f/d ltr. in 5 1/2 mo. for a EG/FR report (Bares). same in 92 ds. after many follow-ups. VIC # 183 (Mayer). same in 6 mo. (Cannon). same in 62 ds. (Byron). Almost everybody submitted a copy of this QSL. Could not run with space available.
- YUGOSLAVIA:** Radio Beograd 9620 via Nis w/ "Sv. Stefan" card and on 15240 via Pristina w/ "Mostar" card. Arrived in 5 weeks w/ a blue pennant (Barto).

Thank you for your report on the reception of our  
 H.F. Verwoerd Shortwave Station  
 RADIC 5

DATE: 23.8.77

TIME: 04h00 GMT

FREQUENCY: 3388 kHz

SOUTH AFRICAN  
 BROADCASTING CORPORATION  
 SUID-AFRIKAANSE  
 UITSAAIKORPORASIE

That's it for this time around gang. We smashed the old record of 118 countries with 128 for this issue. Actually we had 129 as I had left out a report from Ascension Island. We must be doing something right to break the record by such a margin...Sam.

**SPECIAL OFFER:** Your editor and the New England DX Society is offering a special 50 page publication entitled "Verification Techniques". It was written by your editor and co-authored by NASWA member Al Sizer. The publication is intended to assist the avid QSL collector by detailing different methods and techniques used in obtaining QSL's. The article contains over 50 illustrations and a special section on verifying the Russian regional outlets. Several dozen copies have been distributed and the comments have ranged from 'great to fantastic'. Copies are available from your editor for \$2.50 each. Some of the proceeds will be applied towards the New England DX Society Memorial Awards Program....Sam.

**EDITORIAL:** I have received several dozen letters commenting on the new format and organization of the QSL column. The new format along with the illustrations seems to have been very well received. Almost every letter was extremely favorable. Thank you for your comments and support.....In reference to LN-14 in the February FRENDX, it would seem that the quality of printing in FRENDX has increased Immensurably. The February FRENDX was probably the most eye appealing and readable bulletin I have ever seen. Due to the late arrival of Log Section B, one or two pages were out of order; however, this did not diminish from the overall quality of the bulletin. If this is any indication of what is to come, it would seem that our new publisher and managing editor Bill Oliver must be congratulated.....Sam.

Thanks to NASWA member John Tuchscherer we will feature circa and pre World War II QSL's in the April issue.



HAPPINESS IS  
 LETS HAVE YOUR ANSWER.  
 a QSL.



SWAZI  
 RADIO



THE INTERNATIONAL SOUND

# update

March 1978      Number 14

Tom Allemen  
615 W. 43rd Terr., Apt. 6  
Kansas City, MO 64111  
(816) 931-5943    0030-0430 GMT

UPCOMING DEADLINES: 10 March (Mid-March); 20 March (April); 12 April (Mid April)

Reprinting permitted provided credit is given original reporter and NASWA UPDATE. BBC Monitoring Service (BBCMS) items are copyrighted and may not be reproduced without their permission. Dates, times and days are GMT; freqs are kHz.

A very, very light turnout this issue. As always in such cases, I have included some of the more interesting items from the last issue. These are starred (\*\*\*) for easy reference.

- ANGOLA** BBCMS reports that Radio Nacional has b'cast its "B" px of the domestic service on 11955 from 0400-1500 beginning on 17 January. Operates // to 9535. (BBCMS)
- ARGENTINA** R. Nacional, 6060, in SP at 0930 w/ ID by W, talk px. (Jack Jones, MISS; 2-13)
- BENIN** LVRB, 4870, w/ usual px and good sigs after 0100 many nights. Is this a return to their old all-night service??? (Troy Gower, ILL) \*\*\* Tnx for your call with this one, Troy. My monitoring indicates that s/off is 0200v w/ s/on now appearing at 0500a, approximately 45 minutes later than the s/on time used last fall. tba
- BRAZIL** R. Cultura Sergipe, 4775, in PT 0005-0030 w/ latin mx, M anncr, "Cultura" IDs. Poor Tn UTE QRM and noise. (Neal Perdue, ALA; 2-13) +++ R. Clube do Para, 4855, in PT at 0215; very good w/ slow latin mx, M anncr w/ anncmts and full ID. (Perdue, ALA; 2-12) +++ R. Capixaba, 4935, in PT 2255-2315, w/ accordian mx, reverb IDs and anncmts. Het until 2305. Poor but readable throughout. (Perdue, ALA); Capixaba also noted here 2330-2346 w/ PT ID, several ads or anncmts, and accordian mx. Quite good for once. (tba)
- CAMEROON** R. Bertoua, 4750, at 0425 w/ IS of native drums and EG and FR IDs. EG ID: "This is Radio Bertoua (Ber-twa), provincial station of Radio Cameroon." Similarly in FR. Anthem and into px at 0430. (tba)
- CANADA** CFRX Toronto, 6070, in EG at 0957 w/ many commercials (shopping center, Pontiac, etc.), and pop mx. (Jones, MISS; 2-13) \*\*\* Jack, have you heard anything more about those Ontario turkeys you mentioned two or three issues back??? Hi... tba
- CHILE** R. Nacional, 8190, in SP at 1000; possible s/on. Long rendition of other stns in Chile carrying the pr (R. Nac. de this & that city plus others), then into mx. Venezuelan NA underneath (Ecos del Torbes s/on). Used to hear this on 6195. (Jones, MISS; 2-13)
- CHINA (TIBET)** BBCMS reports that the regional stn in Lhasa has announced that it would broadcast a half-hour px in the Changtu dialect twice daily at 0430 and 1400. The px contains regional nx, and reports and articles from domestic and foreign sources. Freqs are 9653, 9490, 5935, 4035. (BBCMS) \*\*\* The 1400 tx may make it to NAM. tba
- COLOMBIA** Ondas del Meta, 4885, in SP at \*0950 w/ NA, ID as "Somos profesionales, somos Ondas del Meta . . .", calls, freqs, and guitar mx. (Jones, MISS; 2-13) +++ LV de los Centaros, 5955, in SP at 1033 w/ ID, TC and campesino mx. (Jones, MISS; 2-13) +++ R. Melodia, 6140, in SP 0800-0905 w/ SP "Canciones de America" (spelling???) px and anncmts by M. ID and TC after nearly every song plus full ID every half hour, mentioning only MW. There was one ID mentioning SW though. (Don Petravick, ILL) +++ R. Nacional, 9655, in SP 1200 w/ ID, mx interlude, and talk on history. (Jones, MISS; 2-11)
- COSTA RICA** According to BBCMS, Radio Cu-Cu, which operates from San Jose on 675 MW, has been observed on 6253 since 20 December 1977 w/ "musical entertainment" only. (BBCMS)
- DOMINICAN REP.** \*\*\*Rudy Espinal announced on R. Clarin on 7 Feb that they hope to add another EG px at 0030 w/ a new host. The new anncr would also substitute for Rudy while he is in the USA for 53 days. (Glenn Hauser, TENN) +++ LV de las Fuerzas Armadas, 4825, in SP 0100-0356v\* w/ low key tiaks and a wide variety of music, mostly light classics and muzak. S/off time varies by as much as twenty minutes from nominal 0400. ID: "LV de las Fuerzas Armadas de la Republica Dominicana . . .". Hadn't noticed this one in a while. (tba) +++ R. Clarin, 11700, in SP at 2234 w/ ID as "Clarin Internacional . . . Emisora Nacional . . .". Read reports from listeners in Spain, Italy, elsewhere, including SINPO ratings. (Jones, MISS; 2-11)
- ECUADOR** R. Luz y Vida, 4830, in SP 0343-0440, poor in QRM from Reloj on 4832. Campos mx w/ talks by W at 0350 and 0420. Finally caught a clear ID 0439, this time by M. (tba) +++ Em. Gran Colombia, 4910, in SP at \*1104 w/ lengthy NA, "Mr. Sandman" theme mx, ID as "Escuchan Em. Gran Colombia", network plug (C.R.N.E.) and into nx. (Jones, MISS; 2-10) +++ R. Splendit, 5025, in SP 0510-0530 w/ several SP IDs, many w/ "Star Wars"- style sound effects, and campos mx. (tba)
- \*\*\***GREENLAND** Godthab, 9575; their IS can now be heard on certain days just prior to 1500 and 1900. Transmitting hours seem rather irregular. Fair to good sigs sometimes. (Victor Jaar, PQ)

GUATEMALA LV de Nahuala, 3360, in SP at 0139 w/ ID, talk and marimba background mx. (Jones, MISS; 2-10)

GUYANA An interesting note from QSL Rpt Editor Sam Barto regarding the Guyanan reported in UD 11 (and inadvertently left out of the last issue-tba): "If my memory serves me right, there used to be a very low powered "outback" Guyanan stn operating just below 3200. It was known as Radio Pork Rocker or something like that. Possibly this pirate has been re-activated???" (Sam Barto, CONN) \*\*\* A good question. Can anyone supply details??? tba

HONDURAS R. Juticalpa, 4781, in SP and local verns at 1220-1230 w/ newsy sounding talks. Very good. (tba) +++ R. Lux, 4890, 0007-0009\*; SP ID, then into nondescript CAm mx. Gone suddenly in mid-song at 0009. (tba)

ISRAEL IBA tentative sked just in from Larry Magne; all px in EG. 0500-0515: 7412, 9835, 11655, 11960; 1200-1230: 11655, 15405, 15415, 17815, 21500; 2000-2030: 9815, 11655, 9009, 9425; 2230-2300: 7412, 9435, 9815, 11655. (Bob Zilmer, WISC)

JAPAN NHK sked for 5 March to 6 May shows no change on Gen service freqs from those now in use. Regional Service changes: 2345-0045 EG to NAM, 11705 will be dropped in favor of 15300 // 15270. (Zilmer, WISC)

LESOTHO LNBS, 4800, booming in w/ verns talks and hymns at 0402 13 Feb. (tba)

MEXICO R. Huayacocotla, 2390, in SP 0159 w/ ID and smooth Mexican mx. (Jones, MISS; 2-10) +++ Su Pantera, 6105, in SP 1240 w/ ID and ads. Good sig but troubled by "grinder" noise observed on this freq in the past. Noise is not an image. (Jones, MISS; 2-14)

MOROCCO RTVM presumed to be the one on 6200 at 2130. Could not make out an ID but lang was AR, and freq was // 6100, also used by them. UD 12 lists Syria here but I've never heard them on 6100, so it's anyone's guess as to who is here. Has also been reported as PRBS, Libya at 2100, and I reported it as such on 15 Jan. Help. (Zilmer, WISC) \*\*\* In UD 12, not yet on the newsstand as this is written, Victor Jaar reports this as NF for Libya /6100. I think that's what this is. tba

MOZAMBIQUE RM, 4896, in lang 0359-0415 w/ IS, EG and lang IDs at s/on. Thought I caught a site ID for Beira. (Dan Morriseau, NEB)

NIGERIA NBC Benin City, 4932, w/ EG ID at \*0433 after usual drums IS. (tba)

\*\*\*PHILIPPINES R. Veritas, 9590 NF, noted lately in UnID lang to approx 1400; EG ID at 1330 and EG px at 1400. Apparent ID: "Radio Veritas, Asia." Noted once to past 1500. (Jaar, PQ)

PORTUGAL Rdf Portuguesa, 6155, tentatively noted from 2300-0100a\*. Audible if Austria isn't too strong. Assume this is HS tx to Azores, since it sounds like the old 4865 tx from Lisbon that caused such a ruckus some while back. 4865 also signed off at 0100a. Caught "Radiodifusao" during s/off but not the rest, because of the speed of talking. Thought it was "Portuguesa" though. Also caught pips and clavichord-like vamp. (Zilmer, WISC)

SURINAM SRS unbelievably returned to 4779 on 20 Feb w/ usual Sunday night px of sexy W amncr in DT and local Pidgin. 0330\*. Level much worse than on 4850; tx trouble??? BACK ON 4850 on 21 FEB!!! TRULY UNBELIEVABLE!!! (tba)

SWAZILAND TWR, 5055, w/ EG talks and ID 0432. (tba)

UNIDENTIFIED Since we have some space this time, I will make exception to the usual rule and print two interesting UNIDs:

UnID noted on 11950 USB 12 Feb 1845-2000. Strong sigs in DT or DN. From 1845-1930, px was a phone in show w/ 14 calls in 45 minutes. No ID at 1900. Radio drama 1930-2000. Phonetic ID: "Radio Tee-an-tray-ear-an-dray-dear-lend-of-pokes-to-den-vee-lens-hav." Help. \*\*\* Though this format does not sound familiar, I suspect Sweden. Would help if we had divisions between words as well as syllables. Keep checking on this. OOPS! Submitted by Bill McDavid, NY. Sorry. tba \*\*\* At 0341 20 Feb, strong px on 4905 w/ talks in Afr lang which I think was Amharic rather than Swahili, and Somali-like chanting. Several mentions of Hargeisa and Kenya. Jazz-style chants w/ orch 0354. Flute vamp and pips on hour, then march mx and apparent mx. Possible exercise px to 0420 when buried by Chad carrier. Also there same time period 21 Feb, but much weaker. Baffling. (tba)

USSR According to USSR HF B'cast Nxtletter 11, RM makes the following changes to NAM on 5 March: cancel 7105, 7205 (to 0100), 7115 (0130-0400), 7440(0100-0400). Add 9665, 9685, 9765 from 0100. (UHN) \*\*\* A local ham tells me that KC area AROs use Moscow 41 meter freqs to tune up their transmitters, "because RM usn't good for anything else." One man's meat is another man's poison. tba

VENEZUELA Finally IDed R. Frontera, 4760, in SP at 0257 w/ ID and freq annmts. 0300\* w/ NA. Had heard this very poorly 0100-0300\* for several weeks. Usually weak and there is lots of phone QRM on channel. (Perdue, ALA) \*\*\* Lots of military traffic around that freq. tba

I tried a new type style for the body of this issue. Do you prefer it or the older style? I have access to both, so your preference will govern. Let me know with your next reports. Hope to see more of you in the April issue. Everyone's welcome. In the meantime, my best to all . . .

73s, *Tow*

# log report *section*



• **Ed. Sec-A: Dan Robinson**

1600 - 4900 KHz

5004 FULTON STREET, N.W.  
WASHINGTON, D.C. 20016

For those NASWA members and IR-A reporters who enjoy the challenge of sifting through the ether for unlikely catches, see SPOTLIGHT below. Thank you for the letters I've received and I hope I see more of them. Keep up with solar activity and geomagnetic conditions as we head into March/April. . .it was about this time in 1973 that ELBC in Monrovia, Liberia was heard for two days running! DXing is never boring. . . .

- \*\*\*\*\*
- \* 4719 SULAWESI RRI-Ujung Pandang: Via phone tip from Gerry Bishop, this stn eventually ID'd here from appx 2130-2245 f/o with pop mx, tlks by W ancr, and into nx 2200; many mentions of Indonesia to ID 2211 "Inilah Radio Republik Indonesia. . ." A surprising catch considering the time, and the fact that this was rptd in other bulletins as Pakistan. UTE QRM makes any reception difficult, however Pakistan was probably here as well around 1/22 to 2145 (BISHOP,ROBINSON)
  - \* 3345 MOLUCCAS RRI-Ternate: 1224-1236 IN, RRI ID by M, into lcl mx px, C&W; before 1230 pgm was //3205 & 3215, VG (Krueger 2/2)
  - \* 4707 VIETNAM Quang Ninh: \*1300 - 1400\* irregular operation(WILLIS-AUS)
- \*\*\*\*\*
- 1628 USA PIRATE WGOR/WFCC: Using both these calls 0405 taking phone calls; pops, wx rpts (BISHOP 2/6)
  - 2200 NICARAGUA Emisora La Lider: 0004 SP, tlk by M; hrd "de La Lider-Nicaragua" then played pop mx (BeeGees); G w/some fade(GAVARAS 1/28) 0200-0215 SP, w/ Ranchero mx, M DJ, mary IDs (BLAIZE 1/24) Also,Field on 1/30.....
  - 2340H COLOMBIA R. Boyaca: ID 0328 as "escuchen R. Boyaca 1170 khz" in SP (FIELD)
  - 2350 JAVA RRI-Yogyakarta: Well hrd at 1330; also hrd 2370 Surabaya same time (WILLIS-AUS) Listed 1 KW TBS--DR
  - 2390 MEXICO R. Huayacocotla: From 0000-0200v\*.....SP w/lcl mx and lots of vocals (ZILMER 1/26) Tlk by M, ID as R. Huayacocotla, mx, QRM fm ship to shore same freq(MCCLURE 1/30) Violin/guitar mx, IDs, TC to 0130\*(BLAIZE) 0140-0200\* nx items mixed w/Star Wars theme; ID 0154 w/freq & calls, mx, (ABRAHAM) Ranchera mx 0034, SP tlks (Bishop)
  - 2390 GUATEMALA LV Atitlan: 0155-0200 SP; rapid rythm mx, M DJ (WINELAND 1/30) Did you hear a definite ID? Suggest you had the Mexican...DR
  - 2420H GUATEMALA R. Rumbos: From 0230 SP, w/mx pgm, ID as Radio Rumbos 0314; 2 x 1210 MW, and probably the UNID Dec IR (FIELD 1/21)
  - 2456 INDONESIA RRI-Dili: 1400 w/excellent signal, //3120 (WILLIS-AUS 1/20)
  - 2467T PAPUA NEW GUINEA R Northern District: Island mx, slow fade, possible YL ancr (UERLINGS 2/4) Time??
  - 2476 CHINA Hangzhou HS: CH tlk by M&W (UERLINGS 1/27) Time 1442 --DR
  - 2490 BRAZIL R. Educ Rural, Coari: 2305-0230\* PT vocals, M from 2345 in seeming rel. tlk, chorals fm 0006, M w/above ID only once at 0033, then W w/uptempo mx px; off with out ID, but M tlking between instr mx to 0229(KRUEGER 1/8) 0150 w/mx pgm, ID and s/off 0230, G (FIELD 1/25)
  - 2510 S. KOREA KBS-Taegu: 1445 in Korean tlk by M, mx also (UERLINGS 1/24)
  - 2980 UNID: Cambodian hrd here at 1315 s/off; could be weather station or some such thing; later, a UTE from a different country is audible (WILLIS-AUS) A Cambodian signal this low seems really strange--DR
  - 3050 UNID: Indonesian stn hrd all January here w/nx relay 1400--possibly RKPĐ Pasuruan (WILLIS-AUS)
  - 3105 UNID: Indonesian 1300-1500, others are on 2880, 3108, 2695 (WILLIS-AUS)
  - 3120 TIMOR RRI-Dili: 1359-1415 IN, light mx, probable RRI ID 1400 w/nx following; Fair signals but bad QRM some days (SARRAZIN 1/19)
  - 3137v GUYANA GBS Action Radio: 0320-0725 EG, DJ w/mx, mostly phone calls w/Happy New Year; TCs GMT-3 (HOBBS 1/1) See 3290---DR

- 3205 BRAZIL R Riberao Preto: 0040 PT, M with speech, weak (FIELD)
- 3205 SULAWESI RRI Gorontalo: 1210-1215 IN, mx, tlk //3215 Menado (KRUEGER 2/2)
- 3210 MOZAMBIQUE RM: 2201-2213\* in PT, AK, EG; rx or commentary in PT and other langs, chime IS, march mx and off (OSTERMAN 1/18) 0253-0320 EG/PT; 0253 M ID as "Radio Mozambique in Maputo" in EG, NA and IS; 0300 W in rx (DELAP 1/16)
- 3215 SULAWESI RRI Menado: 1407 IN, M with rx (BRYAN 1/29)
- 3220 CHINA Peking HS: 1502 CH, with M in tlk (UERLINGS 1/28)
- 3222 TGO Lama Kara: 2214-2231\* FR/vern with hi-life mx, tlk, vocal NA; first time for this one here (KRUEGER 1/24)
- 3223 SWAZILAND Swazi Commerical Radio: 0322 EG, M w/ID, rock mx, cigarette ad (BRYAN 1/17) 0344 EG, W with ads in EG, pop mx (UERLINGS 2/1)
- 3225T SUMATRA RRI Tanjungpinang: 1505 IN, M with rx (UERLINGS 1/28)
- 3227 LIBERIA ELWA: 2205-2223\* in vernacular, pgm to EG ID, NA (KRUEGER 1/26) 2220 EG, pgm notes, NA and s/off (YAJKO 1/21) 2220-2223\* EG, all lang tlk, but EG ID and off with anthem (OSTERMAN 1/26)
- 3235T MOZAMBIQUE Beira: 2245 w/M in tlk in PT, weak signal--Beira listed (FIELD 1/28) Check on this one for a definite ID Marlin--DR
- 3240 PERU R America: 1115 SP, lcl mx, pop mx, vocals (ZIMMER 1/29) 0607-0637 SP, with pop mx pgm, few annts; 0630 SP ID (HOWARD 1/28)
- 3245 VENEZUELA R Libertador: 0300 SP, mellow piano mx (RINKER 1/6)
- 3250 SOUTH AFRICA Springbok R: 0120-0230 EG/AK, MGR mx with M DJ, TCs, full ID and EG mx 0230 (BROUILLETTE) 0151 light piano mx (LEFFLER 1/23)
- 3255 VENEZUELA LV del Tigre: 0125 SP, ID, LA mx, ads (McCLURE 1/30) 0401-0426 SP, ID and soccer coverage between Mexico and Venezuela (CUCURA 2/5)
- 3260 ECUADOR LV del Rio Carrizal: 2250-2300 SP, mx then ID 2251, LA mx and vocals (OSTERMAN 1/18) 2250 w/mx pgm and weak signal (FIELD 1/28) 0305-0314\* SP, rustic del campo mx, M in tlk, long version of NA (KRUEGER 1/9)
- 3275 VENEZUELA R Mara: 0235-0300 SP, LA mx, vocals, orchestral mx and guitar, (THOMPSON 2/1) 0314 mx and ads, IDs (CUCURA 2/5)
- 3280 UNID: French African station here with rx at 18 and 1900 on 1/23; checking all audible FR Africans revealed no // (WILLIS-AUS) Keep me posted--DR
- 3285 BELIZE RB: 0203 EG, rx and contry, mx--Here it is, fans, the GRM capital of the world, 3285 on your dial!! (BURKE 1/26) 0300 w/BEC rx, classical mx (WORD) 0302 BBC rx relay, IDs, ads, wx, SP tlk (SARRAZIN 1/11) 0415 with YL DJ, pop mx (ALEXANDER 1/29) 0500-0505\* EG, M with prayer, hymn and off with GSTQ (OSTERMAN 1/29)
- 3285 BRAZIL R Olinda: 2330 first time hrd this freq (FIELD 1/26) Details??
- 3290 GUYANA GBS: 0901-1000 EG, "GBS Morning Pgm" mx, TCs, ads, rx and birthday greetings, VG (OSTERMAN 1/17)
- 3295 BRAZIL R Tapuy: 0145 with mx to 0300\*; not hrd since (FIELD 1/5)
- 3300 GUATEMALA R Cultural: 0058-0130 SP, mx, ID, rel pgm with SP sermons, (GREENES, RINKER 1/6, PRATH) 0218-0420 EG rel px, Back to the Bible, mx and tlks, (BROUILLETTE, BRYAN, GOLKIN, SWANSON)
- 3307 RHODESIA RBC: 0400-0416 EG, 0400 with ID as RBC, into rx, then mx, lost by 0416 (HOWARD 1/20)
- 3320 SOUTH AFRICA Radio 5: 0329 EG, with mx and ID's (GREENES 1/7) 0340 w/rock mx (ALEXANDER 1/29) 0350 pops, ID 0400 and ads (HOWARD 1/15)
- 3322 PAPUA NEW GUINEA R North Solomons: 1247-1300 in Pidgin/EG w/Phone-In Show, with OM DJ, and "Your Papua New Guinea Phone-In Station..." (OSTERMAN 1/14)
- 3323 UNID: Indonesian here, RRI Jayapura or Jember, 1412-1427 IN, M with ID but couldn't catch QTH--did hear him say Indonesia, and had nice Indo mx (GODFREY 2/3)
- 3325 GUATEMALA R Maya: 1255-1302 SP, rapid instrumentals w/lots of piano, ID 1300 (SARRAZIN 1/31) 0140 SP, pops, campo mx (BISHOP 1/16)
- 3330 PAKISTAN RP: 1505 in Urdu, M in news and ID (UERLINGS 1/23) Any lcl ID?--DR
- 3335 PAPUA NEW GUINEA R East Sepik: 1252 in Pidgin, light islands mx by group vocalists, short annts, into solo M in song (SARRAZIN 1/11)
- 3340 ECUADOR R Tropical: Being hrd fm 0200-0400 if above the lvl of the UTE on this freq (ROBINSON)
- 3350 GHANA GBC: 0645 in vern with M in tlk (UERLINGS 1/24)
- 3355 VENEZUELA R Impacto: 1015 with ads (FIELD 1/10)
- 3355 NEW CALEDONIA Noumea: Good lvl with FR s/on at 1800, not as in WRTVH; good signal, had anthem and cock crow but soon faded (WILLIS-AUS)
- 3364v IRIAN JAYA RRI Sorong: Has been rptd here fm 1130 in //4875 --DR
- 3365 VENEZUELA R Puerta La Cruz: Mx pgm with ID at 1014, P (FIELD 1/31) 0332-0358\* SP, M with LA mx, IDs, and NA (CUCURA 2/5)
- 3366 GHANA GBC: 2254-2308 EG, TC for "11 o'clock" and religious tlks, hymns (HILLMAN 2/10) 2227-2306\* s/off with ID as Voice of the Revolution (McCLURE) 0647 EG rx followed by PSAs and obituaries of late Accra citizens (DELAP 1/20)
- 3375 ANGOLA R Nacional: 0403 w/complete ID at s/on (FIELD 1/29)

- 3380 ECUADOR R Iris: 1120 SP, M ancr with Ecuadorian mx (PRATH 1/15)
- 3380 GUATEMALA R Chortis: 0225-0300 SP, orchestral mx, vocals, SP armts, IDs, and tlks (THOMPSON 2/2)
- 3385 VENEZUELA R Barcelona: 0400\* SP, LA mx and tlk, s/off w/NA (ALEXANDER 1/29)
- 3385 FR GUYANA Cayenne: 0930 in FR mx, tlks and nx (TANNENWALD 1/23)
- 3385 PAPUA NEW GUINEA R East New Britain: 1240-1250 in Pidgin/EG, pop mx and TCs, wiped out by UTE QRN at intervals (OSTERMAN 1/16)
- 3390 ECUADOR R Zaracay: 0431-0459\* SP, nice LA mx and IDs, last ID by M "Radio Zaracay de Domingo de Los Colorados" (CUCURA 2/5)
- 3395 VENEZUELA R Universidad: 1118 SP, M with ID, pops (SARRAZIN 1/24) 0221-0317 LA mx, nx and cmntry, many IDs (BURKE, BLAIZE, CUCURA)
- 3395 SUMATRA RRI Tanjung Karang: Nx at 1400 while on 3392 had a tentative RRI Singaraja, and 3390 a definite Kabul; no Sri Lanka on 3395 anymore (WILLIS)
- 3396 NIGERIA NBC Kaduna: 2140 EG/lang with lcl mx, ID and nx at 2200 (BISHOP 1/15) 2235-2250 in lang chants, by M; SLBC and GBC in good too (KRUEGER 1/24)
- 3396 RHODESIA RBC: \*0355 EG, IS and ID in EG by M, into African nx to 0410, and mx afterward (CONOVER 1/25, WCRD 1/17)
- 3425 NEPAL RN: 1220-1230 in Nepalese with songs by M, tlk (McCLURE 1/8) 1254 M&W in cmntry, lcl mx, ID "Radio Nepal" (ONKEN 1/14) 1345 Nepali/Indian mx with nx by M 1350; tlk by W 1400 followed by classical mx, ID 1404 (GODFREY 1/18) 1343 with exotic mx, 1450 nx and wx (HOWARD 1/17) 1515 with sitar mx and chants (UERLINGS 1/23) 0030 subcont mx, ID 0050, ID and nx by M 0120 (BISHOP)
- 3535 CHINA PLA-1: Fuzhou at 1421 in CH mx and tlk by M&W (BRYAN 1/29)
- 3560 N. KOREA Pyongyang: 1425 in SP, oriental mx, ID by M (BRYAN 1/29)
- 3885 USA PIRATE: 0502-0715 contemporary jazz, then rock mx at good lvl throughout, hrd often (KRUEGER 1/18) This one has been around for some time--IR
- 3940 CHINA Wuhan: 1350-1405 in EG with story "Little Sisters of the Grass", no ID (WALLACE-JAPAN 12/19) 1336 dialogue/drama in CH (POPPIN 1/19)
- 3945 NEW HEBRIDES R Vila: 0803 FR, still hrd here often with deep-voiced M reading nx; signal is quite good between HAM s/on and s/off (SARRAZIN 1/25)
- 3950 CHINA Xining: 1530\* after CH mx and M in tlks, anthem at 1531 (UERLINGS 2/4)
- 3970 GT BRITAIN BBC: 0727 EG //6175, sports (BLAIZE 1/15)
- 3975 GT BRITAIN BBC: 0146 in Hindi tlks, 0540 in Hungarian nx (LEFFLER 1/23)
- 3980 SOUTH AFRICA SABC: 0011-0430 EG/AK usual pgm with pops, ads, TCs, nx at 6:30 (WRIGHT, HOWARD, GRENIER, BRYAN, GODFREY)
- 3985 SWITZERLAND SBC: 0700-0723 EG, ID and freqs, variety pgm and Swiss mx pgm, (BLAIZE, CUCURA, HOWARD)
- 3990 LIBERIA VOA: 0400 EG nx (ALEXANDER) 0542 EG nx (LEFFLER)
- 3995 W. GERMANY DW: 0148-0544 in GM tlks, mx (LEFFLER, ALEXANDER, BAUMEL)
- 3995 U.S.S.R. Kyzyl: 1320 in RS, lcl mx, M&W in tlk (Godfrey)
- 4000 UNID: Stn here 0135 with Mid-East format, straight Holy chants by M, good signal; doesn't //Turkey or Egypt, or Libya--gone by 0210 recheck (SARRAZIN 2/2) I wouldn't think either of the above, or Libya Dave--IR
- 4035 CHINA Tibet: Xizang with quick tempo band mx, M in tlk in non-CH lang, 1425 slow oriental mx with flute, dialogue (POPPIN 1/17)
- 4068 CHINA Huhot: W with CH mx, EG tlk; relay R. Peking 1449 (UERLINGS 2/3)
- 4110 CHINA Urumqi: 1352 with Internationale after oriental mx (POPPIN 1/19)
- 4223 LAOS Houa Phan Radio: ID now confirmed by Isao Ugusa, hrd 1300-1400\* and //6203; this took a few days to ID; early January still there on 4222 (WILLIS)
- 4365 UNID: Indonesian hrd all January, best arnd 1400; I would now guess that it may be located in Sumatra as appears to s/off late, and the modulation is rather poor; believed non-RRI (WILLIS-AUS)
- 4375 INDONESIA RPKD Soppeng: From 1330-1430 hrd well here every day, while 4651 has reappeared as RPD Tk.II Sumlungun, although it is so weak that it may now be another stn altogether (WILLIS-AUS) Simalungun listed TBS possibly inactive--could you stick on these, Mike, and send any further information as to location/news relays/power--thanks--DR
- 4380 CHINA FFS-2: 1100 CH, tlk by M & W (KENYON 1/10)
- 4525 CHINA Tungsheng: Listed here; 1227 Internationale, silence to 1230, when cmntry by W (POPPIN)
- 4603 LAOS Xieng Khouang: Signs off at 1400 almost daily, but watch the Indonesian here; I understand that there is another transmitter at this location, which is also on SW, but I cannot locate it (WILLIS-AUS) Mike, Trenggalek and Serui still in vicinity??
- 4635 TADZHIK SSR Dushanbe: 0045-0130 RS, tlk, some light mx, M1 IS 0059; clear but weak (KRUEGER 1/10) 0147 RS, M/W aners, some RS-type orch mx, fading badly and QRN usually horrid (SARRAZIN 1/31) 0215-0237 RS tlks by M/W, anmt by M 0230 (local ID?) into GREAT Central Asian mx a la Tashkent; UTE knocks them 0237 (ROBERTS-MANITOBA 1/31)

- 4680 ECUADOR R Nac Espejo: 0053-0546 SP, ads and IDs, usual LA tunes, mx at 0300; Ecuadorian mx(CUCURA, RINKER, BAUM, THOMPSON, GODFREY, LEFFLER) 1141 with 1cl mx (ZILMER 1/29)
- 4719 SULAWESI RRI Ujung Pandang: YL anc in tlk 1427, nice Indo mx, (GODFREY 1/25)
- 4755 COLOMBIA Em Nuevo Mundo: 0105-0705 w/Colombian mx, anmts, IDs(ELAZIE, CUCURA, ABRAHAM, LEFFLER) 1103 SP, mx and IDs (TIERS) 1110 LA mx (TANNENWALD)
- 4755 BRAZIL Rdfid do Maranhao: At 0820 with tlk by M and LA vocals; PT (UERLINGS) Were they playing LA SP vocals, or Brazilian mx in PT??
- 4760 SWAZILAND TWR: 0345-0415 with full EG ID 0345; rel mx, portions in EG; strong signal but soon faded (CALDERWOOD 1/22) 0428 w/rel tlk, IS/ID 0430; (BISHOP) 0430-0515 AK tlks, orch mx, vocals, drum mx (THOMPSON) Excellent 1vl fm 1800-1900 w/rel pgms, mary mentions TWR (WILLIS-AUS)
- 4764v SUMATRA RRI Medan: Light MCR mx, tlks by M/W, ID 1430 (GODFREY 1/28)
- 4765 CONGO RTVC: 2207 FR tlk by two men //15190 (YAJKO 1/14) 0400 with nice mx, mary mentions of Brazzaville, Lusambo, Congo (RINKER) 0412 w/mx, ID(McCLURE)
- 4767v SUMATRA RRI Medan: 1511-1514 IN, M with nx, UTE QRM(BRYAN 1/29)
- 4770 VENEZUELA R Bolivar: 0016-0450 with IDs, TCs, YV mx and ads; also 1020 with lots of talks and lively mx (18--eighteen, reporters!!!!!!) Bolivar and Surinam nominated for most popular/most tuned stns this month--DR
- 4770 LIBERIA ELWA: 0709 EG, M&W in tlks, ID, 1cl mx (CUCURA 2/5) 0750 with rel px (ALEXANDER 1/29)
- 4775 AFGHANISTAN RA: 1335-1408 w/mx pgm till 1400, then into EG mx(HOWARD 1/15) 1431 M with s/on anmts in lang to begin nx pgm, 1432 M in nx in lang, but bad UTE QRM (HYWARREN 1/13) 1355-1430 Urdu and EG, 1cl mx, three IDs, EG pgm 1400 with nx, comment by W, American soul song, tlk by M--a regular lately (GODFREY 1/19) EG at 1400; 15390 is hrd 1130-1200 when 15365 is operative: both excellent 1vl(WILLIS) 1505 M in tlk, then 1cl mx: into anthem 1527 then W in nx (UERLINGS)
- 4775 UNITED: From 2320 with man in tlk--too weak to tell SP or PT or other(FIELD)
- 4775 BRAZIL R Cult Sergipe: 0750 PT, Brazilian mx, guitar, IDs and Coke ads TC for GMT-3 (BISHOP 1/20)
- 4780 HONDURAS R Juticalpa: 1123-1145 SP, Mx, ads, anmts, strong(MILLER 1/23) 1200 pgm "Presenta Musical Tropical", complete ID, FM, SW (ABRAHAM) 0602 with nice LA mx, ads, ID 0615 (GODFREY 1/30) Are they running late, Mark--watch this freq, there are a few possibilities--DR
- 4780 SURINAM SRS: 0902-1016 w/DT tlks, IDs, mx (OVERCAMP 12/23, BAYSA 12/22, TIERS 12/27) Hold those old reports fellows, as things usually are changed by the time they are printed--thanks. SRS also noted back here 0405 on 2/18 with the usual (ROBINSON)
- 4785 COLOMBIA Ecos del Combeima: At 1040 and 0330-0826: 0417-0506 SP, New Year's Eve show w/popular songs, IDs, network hookup "Super Cadena de Colombia.." (OVERCAMP 1/1) 0826 SP, LA mx, cmtry, numerous IDs(BURKE 12/31) 1040 with LA tunes(ABRAHAM) 0320 with pops (PYATT) 0436 (POPPIN)
- 4785 BRAZIL R Ribamar: 0350 PT, march mx, M anc (BISHOP)
- 4790 SWAZILAND TWR: 0402-0417\* EG, rel pgm, ID "You have been in tune with TWR, Swaziland, your inspiration station; we are now signing off" followed by IS (HOWARD 2/6) 0330-0400 in lang, EG ID 0345 (ALEXANDER 1/22)
- 4790 PERU R Atlantida: 0430 SP, Mx, ads, anmts, IDs (MILLER 1/24) 0549 tlks(LEFFLER) 0546 series of IDs in SP prior to s/off (BURKE 12/30)
- 4795 BOLIVIA R Nueva America: Music and s/on 1030 with "Radio Nueva America" ID (FIELD 1/25)
- 4800T INDIA AIR Hyderabad: At 1428 tune w/mx, AR/Hindi sound; 1430 M anc in lang followed by tlk in EG mentions of Gt Britain; 1436 end of tlk into more mx; May be AIR as had same signal qualities as Afghanistan's (HYWARREN 1/13)
- 4800 LESOTHO Radio Lesotho: 0415 w/ID and nx, pgm of African mx 0425(BISHOP) 0400 Sesotho w/mx, tlk by M, chorus song sounding like NA, more tlks.... heavy UTE (GAVARAS 1/28) Noted here lately fm 2/16 with excellent signals under UTE, same night as noted Radio Rwanda 6055--DR
- 4800 CHINA RP: Strange time of 2250 w/M&W in CH tlk, //4905(ABRAHAM 1/31) 1230 in CH tlk while looking for AIR(FIELD)
- 4807 SAO TOME E PRINCIPE Radio Nacional: 2145/YL w/nx at 2200-2205; also different day 2256 to 2301 flute and drum mx; 2259 1/2 boys chorus w/out instruments to 2301\*, G(ABRAHAM) 0554 PT, nice 1cl folk mx, W anc w/nx and ID 0600(GODFREY) 0535 w/1cl mx, drums and strings, W anc(EARHART 2/4)
- 4810 SOUTH AFRICA Springbok Radio: 2130 and 0313-0440 w/usual ads, mx(10 rpters)
- 4810 ECUADOR LV de Galapagos: 0210-0250 SP, variety mx pgm; 0213 ID, G(HOWARD)
- 4810 VENEZUELA R Popular: 0000-0110 SP, tlk and tango mx (LEFFLER 1/23, PRATH)
- 4815 UPPER VOLTA RTV: 0622 in FR tlk by M, African highlife mx (McCLURE 1/27)
- 4815 COLOMBIA R Guatapuri: 0100-0450 LA mx, tlk, Colombian style mx, IDs(8 rpters)
- 4820 HONDURAS HRVC: 0315-0400 EG, rel. pgmg, EG anmts and IDs(6 rpters)

- 4825 GUATEMALA R. Mam: 0250 with clear ID; not hrd since (WORD 1/29)
- 4830 VENEZUELA R Tachira: 0451 SP, mx then tlk (BAUM 1/8)
- 4832 COSTA RICA R Relej: 0100-0800, usual ads, LA mx and IDs(5 rpters)
- 4835 BRAZIL Rdfif Teresina: 0240 PT, Brazilian pop mx, ads, M in tlk(BISHOP 1/20)
- 4835 GUATEMALA R. Tezulutlan: 1200 SP, tlk and flute mx(ZILMER 1/25) 0020 SP, marimba mx, M with mention of "R. Tezulutlan"0030 (BISHOP 1/19)
- 4835 SOUTH AFRICA SABC: 2100-2130 & 0300-0430 EG, farm rpts, tlk and ads, lcl wx(HAYES,GOLKIN,KENYON,THOMPSON,BRYAN,ALVI,CUCURA) When SABC freqs in, check for Lesotho and other Mid-Central Africans--Burundi/Rwanda--DR
- 4840T BRAZIL Rdfif Roraima: Presumed the one here 2310 w/two men alternating sportscast (ABRAHAM 1/29)
- 4840 VENEZUELA R Valera: 0251 SP ID, tlk (BAUM) 0340-0400 SP, EL LA mx, M DJ, ID(BLAITZE 1/31)
- 4843 CONGO Pt Noire: 0505 FR tlk by M and W, possibly nx (BISHOP 1/20)
- 4845 BOTSWANA RB: 0356 NA/prayer/hymn; W ancr in EG and Setswana and into mx (McCARTHY 1/29) 0418 in Setswana, pgm of rel mx, W ancr, ment Botswana(HOWARD) 0420 in lang tlk by W (BISHOP 2/1)
- 4845 MALAYSIA Kula Lumpur: 1522 in Bahasa Malaysia, lcl mx and chanting(BRYAN 1/29)
- 4845T HONDURAS R San Ysidro: 0508-0616 SP, apparently a rel pgm/service to 0600, then into popular songs(OVERCAMP 1/1) ID Tom?--DR
- 4845 MAURITANIA Rdfif de la Rep Mauritanie: 2110 w/FR ID as shown(YACONO 1/23) 0732 AR w/mx and vocals/chants; 0830 SRS came blasting in(CUCURA 2/4) 0734 in AR interview between M&W(LEFFLER)
- 4845 COLOMBIA R Bucaramanga: 0302-0402\* SP/EG, various mx, SP IDs, EG "International Program of Radio Bucaramanga" and "Warm greeting to Colombians away from their homeland" (HOWARD 1/25) 0330 EG ID (KENYON) 0300-0400 covering Botswana IS (WORD) 0400\*(RINKER) (also HAYES,ROBERTS,OSTERMAN,MCCLURE)
- 4850 SURINAM SRS: Twenty-three(23) rpters with the following details--At 0327 M in EG "Surinam Broadcasting Station signing off" and NA...Next day, hrd this: "To those who have sent us a reception report, a couple of weeks more and we will write you back because we have to design new QSL cards which have to be printed very soon. So keep on waiting for this new exclusive QSL card of the Surinam Broadcasting Foundation. We are sure it will be the most beautiful one in your collection...Radio SRS, your friendly giant, POB 271, Paramaribo..." (GAVARAS 1/29) 0903 DT,IN,Hindi tlks, ID as test transmission for Indonesian Advertising Agency, ads for General Electric(GODFREY) 0015-0415 ID as "Radio SRS...fantastic radio station in Paramaribo..."(GOLKIN) 0334 or 0434\* depending on day w/usual DJ pgms in DT/EG from (BURRE,YACONO,HOWARD,BROUILLETTE,CUCURA, BISHOP,THOMPSON,ALEXANDER,WORD,HILLMAN,ROBERTS,LEFFLER,UERLINGS,KENYON,BURAS, CONOVER,TANNENWALD) Now that's called giving proper credit--DR ..Also (BOHLKE)
- 4850 CAMEROUN Yaounde: 2130-2258\* w/NA, FR tlks and pops(ALVI,YACONO,CUCURA) 0429-0502 Mw/nx in EG 0511, FR tlks; EG pgm probably //9745(MCCLURE,UERLINGS BROOKWELL)
- 4850 DOM REP R Clarin: 2245-2310 SP, LA mx, TCs, IDs (MILLER 1/18) 0035(FIELD) 0552 (LEFFLER) According to Glenn Hauser, this Xmtr due to be taken off and used as repeater--DR
- 4850 VENEZUELA R Capital: 1000-1100 ads, nx, pop mx, MDJ(PRATH,MILLER,FIELD)
- 4853 YEMEN R Sanaa: 2243 AR tlk by M, mx (YAJKO 1/23) 0335 weak AR chants after SRS s/off (WORD) 0345 AR tlk/speech, mx and singing (BLAITZE 1/31)
- 4855 BRAZIL RC Para: 0332 PT, end nx 0335, fanfare, ID after SRS\*(ROBERTS 1/29)
- 4865 MOCAMBIQUE RM: 0105 EG, M w/speech,"Long Live Mozambique"(CUCURA) \*0255 w/ID EG,FR,PT during IS, into pgm of pop mx (WORD 1/17)
- 4865 BRUNEI Berakas: 1358-1430\* Malay, nx, pop and Indian mx, ID at s/off(GODFREY)
- 4868 UNID: Another UNID stn, French African, hrd 1800-1900;could be Benin but seemed a bit early (WILLIS-AUS) Please inform, Mike--DR Who else but Benin???
- 4870 ECUADOR R Rio Amazonas: 1130 SP, lcl mx, tlk in SP/vern(ZILMER)
- 4871 TRIAN JAYA RRI Sorong: 1340-1400\* IN,C&W, ID by W, Love Ambon and off(GODFREY)
- 4880 SURINAM SRS: 0410-0435\* DT w/ID at s/off(BLAITZE) Sandy, yours the only rpt on this fcy--they were, perhaps,moving around on 1/22 and 1/31--DR
- 4886 KENYA: HS outlet here, but did not s/off at 1900(which would be Kisumu s/off), or at 1935 (which would be Mombasa); so actual site remains in doubt(WILLIS) Most likely one or the other; for sure, not a new site--DR
- 4892 ECUADOR R Centinela del Sur: 0341-0350\* ballads, SP pops, Andes vocals, ID 0344, more mx to 0350\* (ROBERTS 1/29)
- 4895 SARAWAK RM: 1409 in lang, inst mx;NA and s/off 1500(GAVARAS 1/28) Nice,Tom

Just about made it this time....ADVICE--Take care in reading frequencies and IDing stns! Had many mis-IDs...beware Benin 4870 runs past 2300...beware 4780,4840/45 for mis-IDs!! Oh, and try Beira at \*0355 w/multilingual IDs, 4896 or 1800 if you're in Australia.... Don't let better readout make you lazy--until next time,

73ssssss,DAN

# log report section

4900 - 6200

# B

STEVEN C. WISEBLOOD 707 LOMA WAY SANTA MARIA, CA

- 4904.5 CHAD RNT: \*0430-0535 FR & Afro mx, FR nx 0500 & ID (Overcamp, Blaize, Word-GA).  
4905 BRASIL R. Relogio Federal: 2315 PT tlk & ID's (Bishop). 0230 PT ID (Yacono-NY).  
4905 CHINA RP-1: 1410 vocal mx w/orchrestral accompanment (Wiseblood 2/12)  
4908 VENEZUELA R. Carora: 0055-0147 jingles & 40's style mx pgm (Krueger, Bishop, Twiggs)  
4908 KAMPUCHEA Phnom Penh: 1235-1245 M in CB w/cmtrny, local songs (Onken).  
Generally retains a steady 1100-1500 sked despite war, and remains //11942 which has resurfaced. Watch out for Singapore on 11942, 0400-0700 (Willis-AUSTRALIA).  
4910 GUINEA Conakry: excellent 2000, no sign of Lusaka these days. At 1915 Conakry found to be //7253, an old Conakry outlet which I always presumed to be inactive, at least I never heard it from 0600-0800 (Willis-AUS). 2205+ FR tlk (Abraham-MI).  
4911 ZAMBIA RZ: Afro chants and vernicular anmts 0335, ID by M (Roberts-MAN).  
4915 CHINA Nanning: 1409 light vocal and chorus mx, W in CH w/anmts (Wiseblood 2/12).  
4915 BRASIL Rdf Macapa: 0844-0915 M in PT w/fast tlk, ID, PT mx (Tiers, Tannenwald).  
4915 GHANA GBC: 2215-2255 EG religious pgm, EG world and Afro nx read by W (Alvi, Bohkle, Hermann, Yacono). 0600-0700+ EG World nx read by W, vernic. pgm(7 reporters)  
4920 AUSTRALIA ABC: EG nx by M 1305, rock music, fair. (Spece 12/24).  
4920 HONDURAS R. Progreso: 0001-0005 SP talk & ID (Osterman). 0430-0500 LA mx and SP anmts NA 0459, fair. (Roberts-MAN)  
4920 ECUADOR R. Quito: 0402 SP ID & mx (Baum FL).  
4925 COLOMBIA Em Meridiano 70: 0925 SP ID, mx & farm conditions (Tannenwald 1/25).  
4925 CHINA Haerbin: 1349-1410 talk by M & W in CH, W singing, play (Wiseblood, Godfrey).  
4926 EQUATORIAL GUINEA R. Equatorial: 2112-2126 fast Afro mx, NA to 2129½\*(Abraham MI).  
4930 DOMINICAN REPUBLIC R. Mil: 2245-0130 ID's, tlk by M in SP, U.S. & LA pop mx, ads (Twiggs, Speece, Alexander, Cucura).  
4930 ECUADOR R. Casa de la Cultura: W gave ID in SP & some local mx 1230 (Yacono-NY).  
4931 NIGERIA Benin City: 0608 EG VON nx, talk on dam building (Godfrey 1/9).  
4935 PERU R. Tropical: Complete ID at 0405 then s/off, weak (Field).  
4935 BRASIL R. Capixaba: 2345 PT ID & TC (Bishop). 0317 M in PT w/local mx, ID's(Cucura).  
4940 USSR R. Kiev: Very good w/nx at 1900, other USSR's on 4920, 4930(Willis-AUS).  
4940 VENEZUELA R. Yaraucy: 2339-0230 ID in SP, "Musica-Musica" ballads(Baum,Prath,Leff't)  
4940 IVORY COAST RTVI-Abidjan: 2145-2247 Afro-jazz mx, FR talks, //11920(Alvi, Hermann). 0601 local mx, M in FR w/nx(Bryan-CA).  
4945 COLOMBIA R. Colosal: 0125-0915 ID's, LA mx & ballads, accordian mx(12 reporters!)  
4950 SARAWAK RM-Kuching: 1410-1542 EG medical discussion, Classical mx, Sunday pop parade (Grenier, Wallace-JAPAN, Bryan-CA).  
4960 VENEZUELA R. Sucre: 0440 SP mx by W, then anmts(Baum). 1015 SP talk & ads(Zilmer).  
4960v CHINA R. Peking: Japanese service w/M in JP 1301 w/nx (Wiseblood 2/12).  
4965 HONDURAS R. Landia: 1230 ID and TC's "hora en centro-america"(Field 1/10).  
4965 BRASIL R. Poti: 2200 ID, then relay of "A voz do Brasil", mx at 2215(Bishop 1/12).  
4965 COLOMBIA R. Santa Fe: 0126-0445 LA ballads, ID by M in SP(Bryan-CA, Leffler,Anderson).  
4970 VENEZUELA R. Rumbos: 0024-1025, jingles, ID's, LA mx & SP talk (6 reporters).  
4980 CHINA PLA: Signs on 1900 u/Swazi Radio which had an EG religious pgm 1830-1900, and then popular music(Willis-AUSTRALIA).  
4980 VENEZUELA Ecos del Torbee: 2315-0338 LA mx, ads & ID's(6 reporters). 1100 SP ID's and LA mx, M in SP (Prath 1/15).  
4985 BRASIL R. Brasil Central: PT, mx 0743 (Leffler 1/25). 0400 pop mx(Pyatt 2/1).  
4985 SULAWESI Ujung Padang: 1249-1300, Island mx, U.S. pop mx, time pips 1300 //4719, then IS. Bad ute QRM (Osterman 1/29).  
4990 VENEZUELA R. Barquisimeto, 2330-0259 LA vocals, ID's, soccer games(Yacono-NY, Baum-FL, Tannenwald, Leffler).  
4990 NIGERIA NBC Lagos: 2200 ID and EG nx(Abraham-MI). 0500-0527 EG anmts, ID's, TC's, time pips, Vocal mx "I use to be a radio bum -but I'm not anymore"(Poppin, Bryan-CA).  
4990v SOUTH AFRICA R.RSA: PT ID 1916, strong(Willis-AUS).  
4995 PERU R. Ardina: 1055 ID, musical pgm 1110+ (Field).  
5000 SOUTH AFRICA ZUO: 2210-2230 CW ID's and TC's(Abraham). 0325 CW ID's (Mann).  
5000 JAPAN JJJY: poor u/w/v 1349½ & 1359½ "JJY" CW ID, then W in JP & EG w/ID(Abraham).  
5000 ITALY IEF: \*0645-0700\* ID's in FR, EG and FR every 5 minutes (Mann).  
5005 MALAYSIA RM-Sibu: 2230 M in lang, light mx w/v hosting pgm., ID's (Bishop). good LP!  
5010 CAMEROON R. Garoua: 2120-2200\* AR chants & readings by M, AR vocal mx(Kenyon, Anderson). 0500-0627 FR & EG nx, Afro-jazz mx, Afro chants(Overcamp,Leffler,Blaize, //)  
5010 COLOMBIA 0300-0305 ID shouted "Surcolombia", guitar mx, W in SP(Word-GA).(McCarthy/

- 5010 SINGAPORE RS: 1537-1549 EG nx & pop mx, W in EG (Grenier, Bryan).
- 5015 BRAZIL R. Cultura: 0240 ID by M, MoR mx, ads (Bishop).
- 5015 USSR Arkhangelsk: EL mx, M & W in RS 0545 (Bishop).
- 5015 USSR Vladivostok: 1130-1340 Classical piano mx, tlk in RS (Alvi, McClure, Blaize).
- 5020 NIGER ORIN: Afro chants, M in FR 0530, fair-good (Bishop).
- 5025 BRAZIL R. Boborema: 2300 fast Brazilian mx, M w/mentions of Boborema (Abraham-MI). 0746 M in PT, ID's and mx (Tiers).
- 5026t UGANDA Kampala: Heard at 2145 in lang. w/M & W, mentions of Somalia and Egypt. Upeab mx noted. Signal gone by 2155. Definitely an afro. (Hywarren).
- 5030 VENEZUELA R. Reloj Continente: 0133-0457\* SP amnts, vocal mx, soccer match, many ID's (6 reporters). 0935-1130 Conversation between 2 men, jingles and ID, LA mx (Tannenwald, Prath). Lately heard allnight on 5025. (SCW)
- 5033 ANGOLA RA-Cabinda: Local mx, W in PT to 0550 f/out (Bishop).
- 5038 CENTRAL AF REP (Rdf Nat Centrafricaine): 2226-2230 local guitar and flute mx, chants, M in FR w/amnts (Kenyon, Alvi). 0515-0600 flute mx & Afro folk mx, M in FR, drums (Godfrey, Bishop, Brookwell, Blaize, Bishop). Add Hermann 2210-2226 FR talk.
- 5040 VENEZUELA R. Maturin: Soccer match in SP 0135 (Leffler).
- 5040 GEORGIAN SSR R. Tbilisi: 1351-1417 RS vocals and orchestral rx (Alvi 12/10).
- 5040 COLOMBIA R. Cinco: 2305-1000 ID's, ads, LA mx & SP amnts, rock mx (7 reporters).
- 5045t BRASIL R. Cultura-Educativa do Para: good 0222 w/vocal pop mx, M in PT (Wiseblood).
- 5045 BRASIL R. Pres. Prudente: very weak w/mx pgm faded by 0350 (Field).
- 5047 TOGO RT: 2125-2304\* Afro mx, M in FR, NA @ 2303 (Earhart, Overcamp, Alexander, Alvi) 0536-0727 ID, M in FR, Afro folk mx & pop mx (6 reporters).
- 5050 PERU R. Loreto: 0430 SP nx, mx & ID, not heard since 1970 (Field).
- 5050 TANZANIA Dar es Salaam: excellent at 1900, also on 4785. f/in @ 1300 (Willis-AUS).
- 5054 MONGOLIA RUB: Heard to s/off 1500, but 4081 never heard anymore (Willis-AUS).
- 5055 COSTA RICA TIPC: religious mx, ID & TC's, SP talk. Good level (E. Miller) \*1100-1150
- 5057 ALBANIA R. Gjirokaster: 0535-0610 Albanian mx, strong (Leffler, Onken). Clear and good at 1500 and 1600, but the Russian HS on 5055 sometimes provides a problem, as does Pakistan on 5060, when it drifts down (Willis-AUS).
- 5060v PAKISTAN RP: 1300-1314 W reading EG nx, then IS, slow mx (Onken, Osterman).
- 5060 ECUADOR R. Progreso: 0442 SP amnts, mx (Baum). 0709\* SP ID at s/off; Exc. (Howard).
- 5065 USSR Petrozadovsk: Heard as early as 1230 one night w/RS pgm. Normally fades in at 1600, at the earliest (Willis-AUS).
- 5075 COLOMBIA R. Sutatenza: 0137-0400 SP vocals, guitar and country-rock mx, LA mx, TC's, ID's, SP amnts, possible GM pgm 0130-0157 on 1/22 (McClure, Thompson, Leffler, E. Miller).
- 5090 USSR Mayak: 1156 classical mx to chimes at 1200, then W in RS ("presenting the latest bulletins), then M w/nx. (Poppin 1/19) Central Asian location? -SCW
- 5095 COLOMBIA R. Sutatenza: 0105 Instrumental mx (Baum). 1030 SP nx by M (Prath).
- 5125 CHINA RP to Taiwan: \*0958-1900\* alternately in Hakka, Amoy & CH (BBCMS).
- 5135v CHINA RP: 1340 CH mx & tlk by M in lang. (Godfrey 1/31) See 5145!
- 5145 CHINA RP: 1200-1300 & 1400-1500 in Mongolian. 1300-1400 in Russian (BBCMS).
- 5170 CHINA FFBS-2: 1130 tlk by M in CH (Kenyon). \*0230-1435\* Amoy and CH (BBCMS).
- 5205 INDONESIA RRI Palangkaraya: 1340 daily, w/good signals (Willis-AUS).
- 5220 CHINA RP: \*1430-1500\* Sinhalese (BBCMS).
- 5240 CHINA FFBS-1: \*1000-1259\* in CH, weather forecasts in CH/Amoy (BBCMS).
- 5250 CHINA RP: 1030-1100 Quechua to SAM; 1100-1130 Esperanto to Jap/Korea (Sa./Sun.); 1130-1200 Burmese; 1200-1300 EG to Nam; 1300-1400 standard CH to SEA (BBCMS).
- 5260 KAZAKH SSR R. Alma Ata: 1245 M in RS w/lengthy talk, orchestral mx (Sarrazin)
- 5295 CHINA RP: 1100-1200 Cantonese to SEA; 1200-1300 Amoy to SEA; 1430-1500 Sinhalese; 1500-1530 Nepalese and again 1530-1600 (BBCMS).
- 5420 CHINA RP: 1100-1200 SP to SAM; 1200-1230 Tagalog to Philippines; 1230-1300 SP to SAM (save Sa./Sun.); 1300-1330 Indonesian to the islands (BBCMS).
- 5770 CHINA FFBS-2: \*0230-1100\* Amoy/Chinese (BBCMS).
- 5850 BOOTLEG USA: Voice of the Voyager: 0600 w/7 note IS, into EG ID. Played "Wreck of the Edmund Fitzgerald" by Gordon Lightfoot. Then said a few unintelligible words and left the carrier on the air. Poor w/UTE GRM (Gavaras 1/28).
- 5850 CHINA RP: 1000-1100 Mongolian; 1200-1300 Mongolian (BBCMS).
- 5874 HONDURAS IV de Honduras: HRN ID's 1159-1208, SP nx by M. Good (Krueger).
- 5882 ISRAEL IBA relay: 0347-0600 Hebrew ads, ID, pop mx, Exc. (Blaize, Golkin, Roberts).
- 5885 INDONESIA RRI Pekanbaru: 1455 M in Indo w/talk, NA 1458\* (Uerlings-OR).
- 5900 CHINA FFBS-1: \*1000-1215\* in Standard Chinese w/CH/Amoy wx (BBCMS).
- 5900 USSR RM: 0650-0655 EG, Moscow-Mailbag (Wallace-Japan).
- 5900 ISRAEL IBA: 2250-2300 Israeli mx, Commandments of the Law, EG talk (Bohlke).
- 5915 BULGARIA R. Sofia: 2134-2157 EG nx & cmtry, DX propagation, logs (Phillips, Burke)
- 5920 NICARAGUA Rdf. Nat: 1029-1049 SP amnts, ID's, LA mx (Baysa).
- 5920 USSR R. Moscow: 2210-2229\* EG World nx into "People and Events" (Hutchins).
- 5930 USSR Mirmansk(?): Light classical-piano mx 0619 (Leffler).
- 5930 CZECHOSLOVAKIA R. Prague: PT ID & mx 0024-0027\* CZ \*0030+ (Cucura). 0058-0200 IS, ID, TC, EG nx, into SP at 0200 (Welch, Prath, Brookwell, Leffler) 0305-0330+ EG World nx and cmtry (Torsay, Speece, Sarrazin).

- 5975 LATVIAN SSR R. Riga: 2137-2210 in SW w/light EL mx, time pipe, ID and IS on the hour, then into RS pgm (Alvi). 0222 Voice of the Soviet Homeland 5<sup>th</sup> pgm; Semi-Classical mx, talk by M&W in RS. (Brookwell). 0542-0600 Mayak IS, C1 mx(Sarrazin).
- 5940 ASIATIC SSR Magadan: 1737 W in RS, Classical mx (Bryan).
- 5940 USSR R. Moscow: 2330-0230 EG nx and cmntry (Earhart, Anderson, Prath, Leffler).
- 5945 BYELORUSSIAN SSR R. Minsk: 2150-2200\* tlk in Byelorussian & mx (Alexander).
- 5950 CHINA (Heilongjiang) Haerbin: 0636 CH drama w/M & W(Brookwell).
- 5955 PHILIPPINES VOA (Tinang): 1600 EG/Bengali, IS, ID in EG by M, nx (Bryan-CA).
- 5955 COLOMBIA LV de los Centauros: 1015 mx pgm, ID 1035 (Field).
- 5960 CANADA RCI: Now has a regular 'billboard' . . . . . previewing some of the features during the week to come, at the conclusion of Mon GMT pgms (Hauser-TN). 0415-0425 EG "DX Digest" (Hynes). 0530 EG nx, sports and mx (Woltman). ←DW?
- 5965 SWITZERLAND SBC: EG "Dateline" \*0145-0200, nx and cmntry, Good (E. Miller).
- 5965 MOROCCO VOA: 0625 PR, vocal rock style mx (Leffler).
- 5965 BRASIL R. Guaba: M in PT w/ads 0040, soccer match (Uerlings-OR).
- 5975 ENGLAND BBC: 2300-0000 EG nx and cmntry, usual fare (Fraser, Anderson).
- 5980 SIERRA LEONE SLBC: 0757-0800 EG amts, ID's, Afro vocals (Roberts-MAN).
- 5985 GERMANY (WEST) RFE: 0630 HG nx (Leffler).
- 5985 MEXICO XERMX R. Mex: 2200-2230 W in SP, ID's, Mexican vocals(Thompson). 0210 M in SP, Mex. mx (Prath). 1310 M & W in SP, fair w/QRN (Abraham-MI).
- 5990 FRANCE RFI: 0633 FR nx to Algeria (Leffler).
- 5990 JAPAN RJ: 1611-1614 EG M w/nx, tlk about satellite breakup o/Canada (Bryan-CA).
- 5990 MALTA R. Meditterran: 2110-2115\* "Malta Calling" W in EG w/ID, wx (Onken). (Baum/
- 5990 ROMANIA R. Bucharest: \*0130-0147 EG nx & cmnry, IS (E. Miller, Welch, Prath, Torsay, /
- 5995 AUSTRALIA RA: 1136-1205 EG ID, TC's, pop mx, EG nx (Cucura).
- 5995 MARTINIQUE Forte de France: 2307 U.S. rock mx, tlk in FR (Burke 1/29).
- 5995 VATICAN STATE VR: \*0058-0115\* EG religious nx and cmntry, world peace (5 reporters).
- 5996 PARAGUAY LV de Amabay: 0940 mx pgm at 0940, not audible after 0955 (
- 6000 BRASIL R. Inconfidencia: 0717 mixed rock mx & LA mx, M&W in PT (Brookwell).
- 6000 HUNGARY R. Budapest: \*0300-0320 EG nx and cmntry, //7215, 9585 (E. Miller).
- 6005 AUSTRALIA RA: 1140-1623 EG talk, world nx cmntry (Prath, Bryan-CA).
- 6005 CANADA CFCX: 1453-1813 EG talks, mx & nx, ID's (Brouillette, Baysa, Weinhold).
- 6010 VENEZUELA R. Los Andes: 1015 musical pgm (Field).
- 6010 USSR R. Moscow: 1908-1930 EG nx cmntry, UK service, //6175 (Overcamp).
- 6010 ITALY RAI: 0100-0115 EG nx, Italian political crisis(Baum, Welch). \*0140 IT(Cliff).
- 6015 VATICAN STATE VR: 0101 Pope Pauls message (Baum-PL).
- 6015 BRASIL R. Clube de Pernambuco: 0835-1000 PT ads, ID, talk by M (Bishop, Field).
- 6015 AUSTRIA ORF: 0428-0430 EG, "Report from Vienna", EG nx (Welch, Bishop).
- 6020 VENEZUELA R. Anzoategui: 1110 No ID heard, just SP nx and mx (Field).
- 6025 PORTUGAL RP: \*0300-0330 EG nx and cmntry by W, commentary on Portuguese socialists(Prath, Ricchezza, Welch, E. Miller, Leithner). 0457 PT nx by M(Bryan).
- 6025 NIGERIA Romantic mx 2230-2245, EG religious talk 2245-2300, EG nx 2300(Abraham-MI).
- 6025 UZBEK SSR R. Tashkent: 1110 EG commentary (Hayes). \*1200-1229\* EG(Baysa, McClure).
- 6030 GERMANY (WEST) Suddeutscher Rundfunk: GM nx & wx, EL mx 0630 (Bishop),
- 6035 ASTATIC SSR Khabarovsk: 1747 Mayak, mx by Mazurkas(Russian), W in RS (Bryan-CA).
- 6035 AUSTRALIA RA Carnarvon: IS \*2100 & ID, EG nx and pop mx (Bishop 1/28),
- 6040 ANTIGUA DW: 0131 EG nx (Tiers 1/28). DW announced on Jan.27 at 0140 that from 2/2, their tiny pgm to NAM would contain 2 minutes more of features and 2 minutes less of news. I would think this in direct response to a well thought-out critique by David Walcutt, which will appear in the March issue of REVIEW of INT. BDCSTNG(Hauser)
- 6050 ENGLAND BBC: 0640 "Jazz for the asking" (Leffler).
- 6055 CZECHOSLOVAKIA R. Prague: 0643 CZ talk w/vocal mx (Leffler).
- 6065 CANADA CBC: 1210-1233 EG, local wx, "Report on Weekly News" (Cucura).
- 6065 SWEDEN RS: 2100-2130 SCDX #1461, //9605, 11845, "Saturday show"(Hynes, Zilmer).
- 6065 SPAIN RIVE: \*0100-0120 "Panorama", EG nx & cmntry, features(E. Miller). 0206-0300 "Folk Corner", EG cmntry (Welch, Cucura, Prath) 0300-0320 EG nx(Leithner, Torsay). New name for this stn is "Spanish foreign Radio", and new address is PO Box 150139 Madrid, given at 0252 Jan.15, ending a DX pgm in which it said that the sunspots would peak in 1982 at only 55!(Hauser-TN) They'll likely reach that level sometime later this year or early next year. Solar flux now above 120. -SCW (Alexander/
- 6070 CANADA CFRB: 1440-1630 EG nx, wx, ski rpt, MoR mx, Vy.Good(Broyillette, Weinhold, /
- 6070 BULGARIA R. Sofia: \*0000-0100\* EG to NAM, "Mailbag", ID's(Fraser, Welch, Earhart).
- 6070 ASTATIC SSR Vladivostok: Mayak pgm w/Russian chamber mx 1753, W in RS(Bryan-CA).
- 6077 SRI LANKA Medical talk in EG 1335, //9720, usually blocked by 6075 mess(Willis-AUS).
- 6080 SAUDI ARABIA BSKSA: 2120 Two men in AR w/talk, AR mx and ID (Cucura 1/29).
- 6080 HUNGARY R. Budapest: 0215-0225 EG talk about Europe, severe DW QRM (Welch, Prath)
- 6080 BELGIUM BRT-4: \*0015-0100\*; EG to NAM "Belgium Calling", "Mailbag" (12 reporters).!
- 6082 PERU RN del Peru: ID at 1055, mx pgm, QRM de 6085 (Field).
- 6085 GERMANY (WEST). DW:\*0129-0145\* IS, ID, EG nx, tlk and cmntry (Welch 1/10).
- 6090 LUXEMBOURG RL: GM 2351 rock mx, into EG 0000-0200+ top 40 rock (11 reporters!)
- 6090 ASTATIC SSR Irkutsk: 1800 Mayak, RS Symphony mx, time pipe, ID by M in RS(Bryan-CA).

- 6095 POLAND RP: 0158-0230 EG nx, Polish folk mx, EG cmtry (YaJko, Welch, Cucura).  
 6100 LIBYA PRB: 2340 AR type mx, Heard under DW, //9500 (Alexander).  
 6100 MOROCCO RTVM: 2147-2205 M possibly giving nx in AR, DW QRM (Earhart).  
 6100 MALTA DW Cyclops: 0032-0043 PT to Brasil, mx pgn, ID, TC in GMT (Brouillette 1/21).  
 \*0126-0150\* EG nx and cmtry, talk on "Der Spiegel" Controversy (6 reporters)  
 6105 GERMANY (WEST) RFE: 0647 CZ talk (Leffler). Signal strength? QRM? give vital info!  
 6105 HUNGARY RB: 0300-0400 EG ID, M&W in EG w/talk, into HG pgn (Berezowski, Torsay).  
 6110 NED. ANTILLES TWR: \*0250-0300 IS & EG ID, into Radio bible class sermons (E. Miller).  
 6115 MEXICO R. Univ Sonora: 1700 very strong w/SP, classical mx (Brookwell). 2115-2200  
 mostly classical mx, SP talk, several ID's (Thompson).  
 6115 COLOMBIA LVD Llano: 1030-1207 SP nx, ID's, ads, LA mx (YaJko, Prath).  
 6120 USSR R. Moscow: 2313-2330 EG cmtry against U.S./Comalian involvement (McCants)  
 6130 USSR RM: 2307-2330 EG cmtry "what is communism?" (Anderson, Ponder).  
 6135 SWITZERLAND SBC: 0150-0157 EG nx, cmtry on S. Africa (Welch).(Cucura).  
 6135 POLAND RP: 0650 EG, "Radio Panorama", mx (Leffler).  
 6135 BRASIL R. Gaucha: 0305 M in PT w/talk (Uerlings-OR).  
 6140 COLOMBIA R. Melodia: 0158-0207 ID as "R. Melodia, la emisora mas musica", nx and mx  
 New to SW (Krueger). 0455 Soft SP ballads w/several ID's (Uerlings-OR). 1005 complete  
 ID, musical pgn followed by ID. Located in Bogota. (Field).  
 6145 GERMANY (WEST) DW: 0050-0105 GM talk, ID GM nx (McCants).  
 6145 ALGERIA RTVA: Koran chants, AR anmts by M&W (Roberts-MAN).  
 6150 COLOMBIA LVD Huila: 1130 SP pop mx pgn w/M hosting pgn (Prath).  
 6155 AUSTRIA ORP: 0133-0143 EG nx, sports and cmtry & ID (Cucura). 0250-0258 GM talk &  
 Austrian mx (Earhart). \*0328-0356 "Austria Musical Trip", chamber mx (Blossom, Golkin).  
 6160 ENGLAND BBC: 2230 EG, "Reflections", sports roundup (Zilmer).  
 6165 SWITZERLAND SBC: Swiss yodeling (to Eur., N. Afr.), ID, freqs (Leffler). 0654-SCW  
 6165 BRASIL R. Cultura do Sao Paulo: PT talk 2330 //17815 (Zilmer).  
 6170 VENEZUELA RNac: 1100 SP talks & classical mx, Colombia QRM (Zilmer).  
 6170 COLOMBIA LVD la Selva: 1203 SP ID, LA mx, SP anmts, ads (Zilmer).  
 6170 USSR R. Moscow: \*2100-2115 EG to Gt. Brtn. w/EG nx and cmtry (E. Miller). (Cucura)  
 6190 VENEZUELA Ecos del Torbes: 2330-2335, M in SP w/ID and anmts, Poor (Brouillette).  
 6195 PERU R. Cuzco: 1015 vy. weak w/mx, u/Ecos del Torbes (Field).  
 6195 MALAYSIA BBC-Tebrau: 1235-1300 EG "Musical showcase", light mx (Cucura). 1625-1630  
 EG farm nx, the average Euro, farmer is 55 years old (Bryan-CA)  
 6200nf LYBIA PRB: 2100-2202 AR chants, AR tlk abt Mid-East negotiations (Krueger, Zilmer).  
 6200 ALBANIA R. Tirana: 0235 EG nx and tlk by W in EG (Prath). 73,

Steve

.....  
**SCOREBOARD** (continued from page 25)

SCOREBOARD is published quarterly, in the months of March, June, September and December. The information included is number of locations DX'd from (places over 1000 miles apart are different locations), number of years DX'd, model of primary receiver, countries heard (based on the NASWA country list - available from HQ), countries verified, stations heard (a station is a transmitter site), stations verified, and the number of countries heard and verified from the spotlight continent, as well as your favorite QSL from that continent. All you need do is write your totals on a postcard, letter or the back of an old envelope and mail to me by the 15th of the month preceding.

I received a suggestion this time that the standings be arranged in order by countries verified, instead of countries heard. Obviously this could turn the standings around, so let me hear your opinions (with reasons of course) when you send in your next update, which I hope will be before MAY 1978, Spotlight on NORTH AMERICA !!

Let's here from the rest of you out there. It only takes 5 minutes to send in your totals. 73's

*Myra*

.....  
**HELPING HAND:** For sale. HRO-500 (National). \$700 plus shipping. Call Charles A. Taylor, (317) 635-2164 between 0030 and 2230 UTC or write 936 North Temple, Indianapolis, IN 46201

**HELPING HAND:** Must sell. Drake SPR-4 receiver w/AL-4 loop antenna (good for BCB), plus tropical band crystals, all in excellent condition. Asking \$490.00 or best offer, plus shipping. Contact Andrew Kwiatkowski, 9624 Avenue M, Chicago, IL 60617 or call 312/731-9887.

# Ed. Sec-C: log report

6205 kHz to 11700 kHz  
MARCH, 1978

section



Tom Gavaras 16920 17th Ave.N. Wayzata, MN 55391

ALL DX REPORTS FOR THE LOG REPORT SECTIONS SHOULD BE SENT TO OUR DISTRIBUTION EDITOR:  
GREG RAVENHORST, RURAL ROUTE, HOLLANDALE, MINNESOTA 56045! HIS DEADLINE IS THE 12th  
OF THE MONTH!

- 6205 LIBYAN WATERS Mebo II; Noted for a brief period from 2200 to 2210. Abrupt s/on with Man of Action theme, then said that they were 60 miles out of Bengazi and all is OK. Said that they would return at 10 o'clock. Off at 22:12. Were not there at 2155 when I checked. (Lobdell 1/15 via WEDS News).
- 6230 EGYPT R. Cairo; 0100 Spanish pgm with ID (Leffler 1/23). 0100 English pgm of news & mx/9475 (Zilmer 1/28). \*0200-0326 EG Nx, cmtry, mx, Listeners Mail, etc. (Berezowski, Blaize, Yacono, Welch, Conover, Cucura, Bohlke, Burke, Alvi, Hynes).
- 6235 PAKISTAN R. Pakistan; 2055-2147\* Urdu(?) ID, tlk, mx, etc. (Hywarren, Krueger, Hobbs).
- 6261 CHINA R. Peking (Quinghui); \*0953 in Chinese, then blocked by Vietnam (Willis).
- 6261 VIETNAM; Unidentified HS station here. First thought it was Cao Laong (ex 6232), but it does not sign off at 1400, but goes on past 1430 (Willis).
- 7000 CLANDESTINE; (This is a second-hand logging. The following details were noted from a tape sent to Glenn Hauser by the person who heard the station, Timothy Hendel in Miami) "Radio Rebelde," a quasi-amateur operation was active on 12/26 first on 7000 kHz with 2-way contacts, frequently announcing that it would run in a few minutes, a "Christmas Message from a Cuban Mother." At one point called another station, "Segundo Frente Patriótico Militar Unico Movil en la provincia ---." Also called "CQ 40, from COBRER, in Santiago de Cuba." Said message would be on 7025; referred to using the 40m band. Was on AM. Strong signal but some fading indicating not in Miami itself. IDed several times as "R. Rebelde, transmitting from a hidden place in the eastern mountains, especially for the Revolutionary Armed Forces"; another time as "R. Rebelde, unida a R. Libertad Cubana." There was intermittent QRM from a station playing music, which this station also heard and blamed on the Cuban government. When finally got around to the message, IDed also as "Esta es la voz que no tiene mordaza" (The Voice without a gag), then complained about the lack of Christmas celebrations in Communist Cuba. At conclusion, the speaker identified himself as "El Comandante Abito (sp?)." I'm including excerpts of this tape, in the original Spanish of course, on my March 10 (and 11, GMT) "Espacio DX-ista" report on Radio Nederland. (Hauser).
- 7035 CHINA R. Peking; 2245 Chinese talk and march type music (Yajko 1/17).
- 7065 ALBANIA R. Tirana; \*0000-0027\* English News and usual cmtry (Prath, Anderson, Burke). 0345 Arabic talk (Delap) 2035 EG ID (Cucura, Welch). 2237 French talk (Alvi).
- 7070 INDONESIA RRI (Jakarta); 1440-1515\* SP11 Special broadcast of football game with team from Quito playing Angola(?) team in Jakarta. ID's heard at 1449 & 1515 with echo just like S.A. stations "Republica Indonesia" heard on 1/21 & 1/24 only (Godfrey)
- 7090 ALBANIA R. Tirana; 0420 Bulgarian pgm, International into GR pgm at 0430 (Brookwell).
- 7098 INDONESIA RRI (Believed Jakarta); 1200-1350 with relay of 7070 pgm (Willis).
- 7105 ASCENSION ISLAND BBC; 0315-0415\* English w/world Today, cmtry (Thompson, Bryan).
- 7105 MONACO TWR; \*0725-0800\* English ID, Back to Bible, etc. (Mc Clure, Burke, Uerlings, Welch)
- 7105 USSR R. Moscow; 0130 English w/Moscow Review (McGants). 2115 EG pgm (Turner).
- 7110\* INDONESIA RRI (Yogyakarta); 1400 English pgm/11792 (Willis, Godfrey 1/11).
- 7115 BULGARIA R. Sofia; \*0430 English ID w/Bulgarian music (Bohlman, Baum). \*2130-2200\* English talk about the Neutron Bomb & Bulgarian mx (Fraser, Yajko, Turner).
- 7115 USSR R. Moscow (Tadzhik per UHN); 1507 English cmtry on India (Uerlings 1/25).
- 7120 ALBANIA R. Peking; 0145 EG "China in Construction" pgm(Prath). 0330 EG talk (Bohlman).
- 7140 USSR; Unidentified station w/Russian Folk Dance to R. Moscow IS (Once Only) and off at 0430\*. Freq unlisted by BBCMS & Legge gives Alma Ata 1500-1540. Help! (Brookwell 1/22)
- 7150 UNIDENTIFIED; \*0600 Lang & One long African Folk song, sung by man w/African xylop & drums. Also heard 0804\* Spanish singing portions of African folk songs, with short talks between mx, one boy made mention of Malabo, speech, etc. Eq Guinea? (Godfrey).
- 7150 USSR R. Kiev; 0029 English IS, Identification & News (Welch 1/15).
- 7150 USSR R. Vilnius; 2300 EG News & interview of YMCA worker in USA (Earhart, Turner).
- 7155 SPAIN RTVE; 2035 English news & item on Common Market (Welch 1/21).
- 7165 ETHIOPIA V. of the Ethiopian Revolution; 1725-1755\* EG w/xmas carols (for Captic xmas), remainder of broadcast was rather unhumanitarian diatribes against Somalia. (Gans 1/7)

- 7170 NEW CALEDONIA R. Noumea; 0730-0813 French ID w/Jazz mx (Bohlman, Brookwell).
- 7170 TURKEY VOT; \*2130-2300\* English News, DX pgm, etc. (Pickard, Earhart, Hutchins, Welch).
- 7190 USSR R. Moscow; \*2230-0100\* EG News, cmntry, etc. (Fraser, Baum, Anderson).
- 7190 YEMEN PDR DYBS; 0343 Arabic talk & orchestra music (Sarrazin 1/7).
- 7205 USSR R. Moscow; 0005 English News w/New Years pgm (Anderson 1/1).
- 7210 PAKISTAN R. Pakistan; 1400 with local news now on this new frequency (Willis).
- 7210 SWITZERLAND ICRC; 2200 English news of the Red Cross Activities (Pyatt 1/23).
- 7215 USSR R. Kiev; 1930 English with music from the Ukraine (Turner 1/28).
- 7215 USSR R. Vilnius; 2315-2330\* English commentary on farming, mailbag (Fraser).
- 7225 RWANDA DW; 0430-0510 English world rx, Panorama, orchestra mx (Berezowski, Thompson).
- 7230 CYPRUS Cyprus Bc. Corp.; \*2215 Guitar IS, Greek ID, tlk & mx (Onken 1/14).
- 7245 ANGOLA R. Nacional; 0500-0645 Portuguese talk, pop mx, etc (Alexander, Uerlings, Godfrey)
- 7250 JAPAN R. Japan; 1430 Bengali w/IS, Identification & News program (Godfrey 1/18).
- 7260 CANADA RCI; 0310 Russian news (Cliff 1/15). -I have England listed as transmitter site here! (Editor).
- 7260 USSR R. Kiev; 0310 English news and commentary program (Leithner 1/16).
- 7260 USSR R. Rodina; 2345 Russian talk by man & commentary by female (Mc Cants 1/11).
- 7265t MALTA DW\* 2050-2120\* AR talk, DW ID & off (Earhart)-I have lang listed as Maghribi--
- 7270 POLAND Polish Radio; 0202 English news about Carter's trip to Poland (Baum).
- 7270 SOUTH AFRICA RSA; \*0259-0421 EG ID, Good Morning Africa, etc. (McCants, Grenier, Bryan). 0426 Lozi ID, IS, Orchestra mx, talk. drum mx, etc. (Thompson 2/1). & Mann).
- 7275 NIGERIA VON; 0615-0745 English ID, News, Native mx, etc. (Bohlman, Alexander, Leffler)
- 7280 LIBERIA VOA; \*0300 English ID into African Safari, news, etc. (Baum, Welch)
- 7300 ALBANIA R. Tirana; 0245\* English cmntry & Folk music (Anderson, Cliff, Prath).
- 7325 ENGLAND BBC; 0000-0030 English news & Radio Newsreel (Brouillette 1/16).
- 7335 CANADA CHU Time Station; 2332 EG & FR Time announcements every minute & pips (McCants) CHU now in A3h or some form of compatible SSB in USB mode (Magne).
- 7340 USSR R. Moscow; 2040 German talk and Identification (Cucura 1/29).
- 7345 CZECHOSLOVAKIA R. Prague; 0100 English news, Mailbag, etc. (Turner, Leithner, Prath). 2330 Spanish pop music request program (Brouillette 1/16).
- 7360 USSR R. Kiev; 0300 English talk about USSR unemployment vs USA (Bohlman).
- 7360 USSR R. Moscow; 2155 English tlk w/Russian mx (Bohlke). 2330 Spanish nx (Anderson).
- 7360 USSR R. Vilnius; 2308-2328\* English w/Question & Answer pgm, mx, etc. (Mc Clure).
- 7375 VIETNAM VOV (Hanoi); 1100 Vietnamese talk by man & woman (Prath 1/E).
- 7400 USSR R. Kiev; 0304 English cmntry on 60th Anniversary of Rev in Ukraine (Phillips).
- 7400 USSR R. Moscow; \*0130 Spanish program with usual Interval Signal (Riccchetta).
- 7400 USSR R. Vilnius; 2300 English news and commentary (Phillips, Prath).
- 7412 ISRAEL IBA; 0515\* French News (Baum, Godfrey). 2000 English Review of the Week (Turner) 2230 English news and commentary. Hebrew at 2300. (Brouillette, Welch, Prath).
- 7500 AUSTRALIA VNG Time Station; 1246 Time pips with good signal (Abraham).
- 7512 VIETNAM VOV (Tay Nguyen); 1435 Vietnamese talk with some revolutionary mx (Hywarren).
- 7600 ECUADOR HD2IOA Time Station; 0146-0355 Spanish time announcements & pips (Golkin, Baum)/
- 8112 CLANDESTINE; Czech number station by woman, mixing w/hl-speed RTTY at 0220 (Hauser).
- 9022 IRAN VOT; 0052 Farsi talking & music (Leffler 1/23).
- 9022 UNITD; 0240 Talk in Arabic like lang, No ID. Could this be Iran still on past 0230? (Speece 1/29). -Most likely (editor)-
- 9090 CANADA CFRB Harmonic; (9 X 1010=9090) 1630 English talk & mx (Alexander 1/14).
- 9173 CANADA CHU; 0430 EG turned up on this odd freq. Very poor. After tip from Dave Walcutt. Neither of us can figure out any relation between this & CHU's normal three frequencies. (Hauser 1/20).
- 9360 SPAIN RTVE; 0030-0255 Sappn ID, talk, Piano mx, etc. (Brouillette, Baum, Thompson).
- 9410 ENGLAND BBC; 0025 English commentary program (Anderson 1/2).
- 9420 KOREA (NORTH) R. Pyongyang; 0040-0059\* Spanish talk (Brouillette, Leffler). 1345 Spanish ID into talk about Cuba (mc Clure). \*2200 IS into Korean program (Alexander).
- 9435 ISRAEL IBA; 2230 English w/This is Israel, nx, etc. (Miller, Hynes, Torsay).
- 9450 USSR R. Moscow; 1143 English ID & Mailbag (Cucura). 1450 lang w/talk & mx (Alexander).
- 9470 USSR R. Moscow; 0030 Portuguese Identification & talk (Uerlings 2/5).
- 9460 PAKISTAN R. Pakistan; 1425 Urdu talk into National Anthem & s/off at 1431 (Uerlings).
- 9475 EGYPT R. Cairo; \*0200-0300\* English ID, News, mailbag, etc. (Prath, Blaise, Brouillette, Earhart, Hynes, Miller, Speece, Thompson, Cucura).
- 9480 ALBANIA R. Tirana; \*2030 English news program (Weinhold 1/22).
- 9497 PHILIPPINES FEBC; 1200-1300 Vietnamese pgm into Burmese (Willis).
- 9500 LIBYA PRB; 2250-2345 Arabic ID, tlk & mx/6100 (Alvi, Alexander, Leffler).
- 9505 AUSTRALIA R. Australia; 1804-2038 English ID, nx, rock mx (Howard, Yajko, Hynes, Bryan).
- 9505 DOMINICAN REPUBLIC RTV Dominicana; 2122 Spanish w/pop mx, cmntry, ID, etc (Krueger).
- 9505nt KUWAIT R. Kuwait; 1305 Powerful signal with talking in Arabic (Willis).
- 9505 SWEDEN R. Sweden; 0030-0100 English News, SCIX (Hynes, Hywarren, Bohlke) 0120 Swedish talk (Plambeck). 0230-0300 English Panorama, ID, SCIX, etc. (Grenier, Uerlings, Woltman).
- 9515 MALAYSIA R. Malaysia; 1432 Malay talk by man w/news program (Uerlings 1/27).
- 9515 URUGUAY SODRE; 0000 Spanish talk & News (Zilmer). 0228 English ID & cmntry (Baysa).

- 9515 TURKEY VOT; 0405 Turkish talk and stringed music. Not in//with 7170 (Earhart 2/5). \*2130-2300\* EG ID, nx (Pickard,Torsay,Anderson,Prath,Conrad,Berezowski,Fraser,Uerlings)
- 9517 PERU R. La Cronica; 1159 Spanish ID with Peruvian style music (Zilmer 1/23)
- 9525 INDIA AIR; 2000-2110 English news & cmntry, press review (Prath,Burke,Hynes).
- 9525 POLAND Polish Radio; 0312 English ID and commentary (Uerlings 2/1).
- 9525 USA WYFR (Scituate); 2359 English language lesson with ID (Greenes 1/14).
- 9530 BULGARIA R. Sofia; \*2130 English news, cmntry, spectrum (Zilmer, Miller).
- 9530 GREECE VOG; 1930-1950 News in German (Torsay 2/1)
- 9530 USSR R. Peace & Progress; 2320 French talking (Leffler 1/22).
- 9535 CANADA RCI; 0100 IS, English ID, DX Digest (Greenes). 0200 English news (Hynes).
- 9540 AUSTRALIA R. Australia (Shepparton); 1020-1115 English ID & pop mx (Cucura,Prath).
- 9540 POLAND Polish Radio; 1655 English w/Poland This Week into French at 1700 (Berezowski)
- 9540 USSR R. Tashkent; 1215 English talk & Music (Prath 1/29).
- 9545 GERMANY (WEST) DW; 2336 Spanish Mailbag (Leffler). 0347 Spanish talk (Bryan).
- 9545 ANTIGUA DW; 0146-0150\* English w/DW ID and Caribbean Relay ID at s/off (Brouillette).
- 9550 CUBA RHC; 1536-1645 Spanish Identification, talk & music (Cucura, Leffler).
- 9560 ECUADOR HCJB; 0100-0300 EG w/Unshackled, DX Party Line (McCants,Brouillette,Thompson Hynes).
- 9560 USSR R. Moscow; 2000 English news program (Weinhold 1/22).
- 9560 JORDAN R. Jordan; 1700 English ID, Easy Listening mx, news, etc. (Onken 2/4).
- 9570 QATAR QBS; 1335\* Arabic chants, talk & music (Onken 2/4, Abraham).
- 9570 ROMANIA R. Bucharest; 2338 Romanian talking (Leffler 1/22).
- 9575 ITALY RAI; 0110 English News (Prath). 2340 Italian talk & Classical mx (Leffler).
- 9580 AUSTRALIA R. Australia (Shepparton); 1155-1300\* English ID, pop music, weather, cmntry, etc. (Fraser,Phillips,Cucura,McCants,Turner,Prath).
- 9580 ASCENSION ISLAND BBC; 0045-0330 English news, ID, etc. (Thompson, Cucura, Prath).
- 9580 CANADA BBC; 1646 English talking with music (Leffler 1/22).
- 9580 ENGLAND BBC; 2135-2330 English w/World Radio Club (Miller 1/25).
- 9585 HUNGARY R. Budapest; 0150 Hungarian program. Poor signal (Plambeck 1/14).
- 9585 JAPAN R. Japan; 1210 EG ID (Cucura). 1305\* EG News (Yacono,Yajko) \*1400 EG Nx(Weinhold)
- 9585 SOUTH AFRICA RSA; 2130 English w/Saturday Night RSA (Hutchins). \*2230-2320\* English News, DX Corner, etc. (Thompson,Alvi,Miller,Cucura,Hynes).
- 9585 SOMALIA R. Mogadishu; 1806-1820\* Arabic ID, talk & music (Leffler, Yacono).
- 9590 MALTA DW; 1358 w/IS, ID, into Hindi News with music (Alvi).
- 9590 NETHERLAND ANTILLES R. Netherland; 0226\* EG nx (Welch,Hynes). 0552 EG w/DXJB (Hynes).
- 9590 NORWAY R. Norway; 2200 English with Norway This Week//9610 (Zilmer 2/5).
- 9590 PHILIPPINES R. Veritas; 1330-1445 English ID, NX, "Who is my Neighbor," etc. (Alvi, Cucura, Hynes, Conover, Hayes).
- 9590 of February SRI LANKA should be R. Veritas instead, w/Sinhala pgm to Sri Lanka(Osterman)
- 9595 BRAZIL R. Cultura da Bahia; 0050 Portuguese tlk & ID(Earhart). 1135 Portuguese ID(Yajko)
- 9600 ASCENSION ISLAND BBC; 0815 English program (Berezowski 1/8).
- 9605 GERMANY (WEST) DW; 0135 English with world news & views from Germany (Bohlke 1/12).
- 9605 SEYCHELLES FEBA; 1721 Interval Signal & talk in lang. QRM from RFI (Berezowski).
- 9605 SWEDEN R. Sweden; 2315 English with Sweden Calling DX-ers (Hynes).
- 9605 VATICAN STATE Vatican Radio; 0100 English w/talk about a Cardinal in Bogota (Earhart).
- 9610 AUSTRALIA ABC (Perth); 1120-1602\* English news, mx (Conrad,Bayss,Plambeck,Cucura).
- 9610 NORWAY R. Norway; 2210-2230\* English ID & talk on Norwegian customs (Godfrey 1/29).
- 9612 ETHIOPIA R. Ethiopia (Not Sure if this is now called the V. of Rev Ethiopia) Heard at 0500. (Willis). -Language? (ed)-
- 9620 ENGLAND VOA; 2035 Arabic program (Krueger 1/29).
- 9620 YUGOSLAVIA R. Yugoslavia; Much ballyhooed new international service, is actually just a new name for R. Belgrade at the outset, noted on 2nd day of operation in EG closing at 2212 (Hauser 2/1). 2200-2215 EG ID, Nx(Miller,Earhart,Phillips,Uerlings,
- 9625 CANADA CBC NS; 1100 English Saturday Show (Zilmer). 1325 EG News (Welch). Bohlke). 1600-1647 EG Sunday Morning pgm (Leffler,Fraser). 2301 English news (Alvi).
- 9630 USA WYFR (Okeechobee); 2200 English ID, Nice mx & Religious pgm (Hutchins).
- 9635 IRAQ R. Baghdad; 2113 French talk by man (Uerlings 2/4).
- 9640 GERMANY (WEST) DW; 1930-2135 German talk & music (Bohlke, Fraser).
- 9645 BRAZIL R. Bandeirantes; 0030 Portuguese with soccer game (Zilmer 2/2).
- 9645 NORWAY R. Norway; 2207 English News with events of Norway (Hillman).
- 9645 VATICAN STATE Vatican Radio; 2000 English with Religious news (Zilmer 1/21).
- 9650 LIBYA FRB; 1900 Arabic music, news and identification (Yacono 1/24).
- 9650 PHILIPPINES WJA (Tinang); \*2230 ID for Philippines, theme into Indonesian pgm (Alvi).
- 9650 TUNISIA RTV; 1810 Arabic transmission (Leffler 1/22).
- 9655 COLOMBIA R. Nacional; 2300-0200 Spanish tlk & classical mx (Alvi,Cunningham,Prath).
- 9655 CUBA RHC; 0045 Spanish Operatic Duet by man & woman (Leffler 1/23).
- 9660 VENEZUELA R. Rumbos; 1115 Spanish talk and pop music (Prath 1/8).
- 9665 USSR R. Peace & Progress; 1428 English program with IS (Earhart 1/20).
- 9670 AUSTRALIA R. Australia (Shepparton); \*1400 English ID & News (Weinhold 1/22).
- 9670 PORTUGAL R. Trans Europe; \*0630 EG w/talk about the miracle of Lourdes (Burke).
- 9675 BRAZIL R. Diario da Manha; 2300 Portuguese talk w/Brazilian Rock music (Bishop 1/11).

- 9680 LEBANON R. Beirut; \*0130-0300 French/Arabic/English. Fairly good level at times, 1/2 hour in each language, ID's, news, etc. (Burke 1/14, Onken 1/13).
- 9684 TANZANIA R. Tanzania; At long last heard to 1500\*. Have tried many a month for this, always blocked by USSR, Algiers, Taipei & jamming (Willis). -Lang? (Ed)
- 9685 ALGERIA RTVA; 2330 Arabic talk, time pips, news (I believe to 0005\*) (Zilmer 1/25).
- 9685 BELGIUM RTB; \*0015 English with Belgium This Week, ID (Brookwell, Phillips, Zilmer).
- 9685 BRAZIL R. Gazeta; 0015 Portuguese coverage of Soccer game (Zilmer 2/2).
- 9685 CUBA RHC; 0118-0330 English News, ID, propaganda, mx (Welch, McCants, Bohlman).
- 9690 ARGENTINA R. Argentina; 0048-0125 Spanish tlk & mx (Leffler, Tiers). 0350 English news summary & music (Anderson).
- 9690 USA WYFR; 2020 English with Bible Readings (McCants 1/11).
- 9695 SWEDEN R. Sweden; 2300-2330 English ID, SCDX (McMullen, Golkin, Welch, Bohlke, Hynes).
- 9695 USSR R. Moscow; 1505 English with news read by YL (Uerlings 2/1).
- 9700 GERMANY (WEST) DW; 0050 German talking (Leffler 1/2).
- 9700 SWITZERLAND SBC; 0143 IS, English ID, Nx, SW Merry Go-Round (Brouillette 1/29).
- 9705 MEXICO R. Mexico; 0135 Spanish tlk & mx (Earhart). 1335 Spanish tlk & ID (Cucura).
- 9715 HOLLAND R. Nederland; \*2128-2220\* EG ID, Studio Six (McCants, Fraser, Thompson, Miller)
- 9720 SRI LANKA SLEB; 0129 English with Back to Bible pgm (Wright). 1850-1948\* English with pop music, commercials, requests for reports, etc. (Miller, Bryan, Hutchins).
- 9720 KOREA (SOUTH) R. Korea; 1802\* English w/news & Sunday Magazine (Grenier, Wright).
- 9720 USSR R. Station Atlantika; 1650 Russian ID & Jazz style music (Leffler 1/22).
- 9725 SWITZERLAND SBC; 0143+ English w/Dateline, Swiss SW Merry-Go-Round (McCarthy, Wright, Bohlke, Baum). 0345 End of French pgm into Italian program (Alvi)
- 9730 GERMANY (EAST) RFI; \*0100 English ID, nx, talk on sports, etc. (Burke, Bohlke, Baum). 1835 English news & political talk (Yajko).
- 9730t SAUDI ARABIA BSKSA (Riyad); 2125 Arabic with strong carrier but not the modulation to match. Talk w/Soap Opera, music, talk. Heard no ID. (Earhart 1/8).
- 9730 UGANDA UBC; (tentative) 1955 Arabic music & chanting (Uerlings). 2030-2100\* English news, ID & pop music (Osterman, Roberts, Mc Clure).
- 9735 RWANDA DW; 1528 French ID w/African mx (Alvi). 2030 German talk & mx (Delap).
- 9740 EGYPT R. Cairo; 0145 Spanish program (Flambeck 2/2).
- 9745 CAMEROON R. Yaounde; 0624 French commentary by two men (Uerlings). 2055 French ID & African mx (Roberts). 2220 African mx & talk in French by YL (Abraham).
- 9745 IRAQ R. Baghdad; 1930\* Ending of English pgm (Baum). 1930-2028 French ID & News (Fraser, Ricchezza). 2030-2130 German program (Ricchezza). 2130-2230 English news music & cmntry (Ricchezza, Miller, Yacono).
- 9750 ALBANIA R. Tirana; \*0000+ English talk about Albania & USSR (Miller, Woltman).
- 9750 SWAZILAND TWR; 0456-0540 Interval Signal, German ID, Schedule, Relig. pgm (Hillman).
- 9760 GREECE VOG; 2143 Greek music & ID (Hillman). 0015+ English ID, News & mx (Alexander, Mann, Kenyon). 0216+ English ID & News (Miller, Welch).
- 9765 ASCENSION ISLAND BBC; 2300 Portuguese ID and news. Poor. (Alvi).
- 9765 SWITZERLAND SBC; 1315 English news, Jazz mx (replaces 15305)///15140 (Zilmer 1/22).
- 9780 ALBANIA R. Peking; 0100 English news & cmntry (Turner, Miller). 0300 EG News (Prath).
- 9770 AUSTRIA ORF; \*0000 German program (Fraser). 0130 English news, cmntry, brief pgm about Schubert (Miller, Burke).
- 9770 GREECE VOA (Kavala); 0406 English with the Breakfast Show (Golkin 1/2).
- 9770t MOROCCO VOA; 1900 Albanian program into Russian pgm. Fair level (Delap 1/19).
- 9770 NETHERLAND ANTILLES R. Nederland; 0734 English with Happy Station (Grenier 2/5).
- 9770 SEYCHELLES FEBA; 1835-1845\* Arabic religious pgm, ID & IS. (Roberts 2/2).
- 9780 YEMEN ARAB REPUBLIC R. San'a; 1835-2111\* Arabic talk, news, chantings, ID and off with National Anthem. (Uerlings, Bryan, Hutchins, Onken, Alexander).
- 9810 USSR R. Moscow; 0312 Spanish news, ID's. UTE Interference (Delap 1/19).
- 9815 ISRAEL IBA; \*2230-2300\* English with news, Speech by Bagin, cmntry, etc. (Fraser, Torsey, Alvi, Thompson).
- 9820 USSR R. Moscow; 0200 ID. Sounded like a newscast. (Conrad 2/2).
- 9850 EGYPT R. Cairo; 2135-2227 Arabic music, chants & talk (Yacono, Alvi).
- 9912 INDIA AIR; 0010 English ID, nx (Kenyon). 2210 English cmntry about social and economic problems in India//9525 (Yajko, Osterman).
- 9915 ENGLAND BBC; 0025 English with Radio Newsreel (Bohlke). 0209 English ID, news and commentary on Indonesian Religious Cultures (Cucura).
- 9920 CHINA R. Peking; 1225 English talk about Mao Tze Tung (Prath 1/8).
- 9940 CHINA R. Peking; 0120 English cmntry on Latin America, opera mx (Greenes 1/16).
- 9950 INDIA AIR; 1516 Unknown lang with talk & news (Uerlings 1/27).
- 9977 KOREA (NORTH) R. Pyongyang; 1840 English ID w/political talk (Howard). \*2300-0047\* English ID, endless praises of Kim Sung, talk on Korea & Revolution, etc. (Brouillette, Welch, Speece, Earhart, Alvi, Cucura, Phillips, Alexander).
- 10000 JAPAN JJX Time Station; 0015 Time pips between WWV w/CW announcemnet (Wright 1/21).
- 10000 HAWAII WWVH Time Station; 0331 English time by woman w/time pips (McCants 1/31).

- 10040 VIETNAM VOV (Hanoi); \*1300 French Identification & talk (Cucura). 1355+ Vietnamese talk & S.E. Asian music (McClure). 2030+ English Identification, news, cmntry, orchestra mx, etc. (Hutchins, Greenes).
- 10100 CANADA CFRB (harmonic 1010 X 10); 2102 English ID, News. Then buried between Havana in-flight SSB and RTTY (Hutchins 1/14).
- 11515 CHINA R. Peking; 2346 Chinese talk and music (Yajko 1/13).
- 11535 KOREA (NORTH) R. Pyongyang; \*2300-0048\* English Identification, talk about the rise of living costs in South Korea, etc. (Mc Clure 1/17, Wright 1/15).
- 11595 USSR MAYAK; 1659 (SSB Relay) in Russian with some music, ID, Interval Signal & Time Check. Fair (Hywarren 1/22).
- 11620 INDIA AIR; 1755 Hindu music, English announcements, ID's. Fair-Good with Utility interference//9525 (Roberts 1/15).
- 11675 CHINA R. Peking; 0030 English pgm w/Music from China (Leithner 1/28).
- 11690 USSR R. Vilnius; 2302 English cmntry by man & woman (Tiers 1/15).
- 11700 DOMINICAN REPUBLIC R. Clarin; 1619 Spanish music (Leffler). 2137 English with Travel tips, pleas for QSL reports, etc. (Ponder). 2202 Spanish ID & talk (McCants). 2300-0000 English International Service with Rudy Espinal reading letters from Listeners & playing music from the Dominican Republic. (Anderson, Swanson, Miller, Grenier, Baum, Welch, Leithner, Greenes, Alexander, Brouillette). Rudy Espinal asked for sample copies of DX magazines so he could prove to tourist agency they're getting out, and be able to get goodies to send to listeners 1/10 2322. Also said Radio Clarin has no government backing. 1/17 said he would be away in Miami for three days translating for President Balaguer. Hopes to do program in German if reception allows, perhaps seasonally. Subsequently devoted long periods to publicizing SPEEDX, ASWLC and NASWA (Hauser).
- 11700 LIBYA FRB; 1828 Arabic talking // 9650 (Alvi).
- 11700v CHILE Voice of Chile; 0215 English news, music & talking about Chile (Woltman 1/15).

Just a few requests. First, please send only your most recent loggings. I received a lot of reports for stations heard in December. Secondly, be sure to include the frequency, country, station heard, time, language, a few program details, your name and the date you heard the logging with each report. I suggest that you write to our Distribution Editor and request some NASWA reporting forms, if you do not have them. You will find them very helpful.

Thirdly, if you do not use the NASWA Reporting Forms, then please keep your report to within an inch in width. I have been receiving some reports up to five inches in width!

A big THANK YOU goes to Jim Roberts and the members of the University of Manitoba DX Club for a fantastic weekend in Winnipeg, Manitoba! We all had a great time! Incidentally, I recently purchased a Sony ICF-5900W receiver, so I can keep in touch with short wave whenever I am away from home. It should come in very useful at the university. I have found that the Sony does a good job in pulling in the short wave stations, but I am disappointed with the sloppy FM!

Thank you to all who reported this month and welcome to all who reported for the first time. I hope you will continue to report as often as possible!!!

Before I close, I would also like to add my thank you to Alan Mayer for a job well done and greetings to our new Publisher: Bill Oliver!!!

Until April,

73,  
J  
Tom

HELPING HAND: For sale. Drake SW4A in excellent condition, with MS-4 speaker. Only \$185.00/best offer. UPS shipping included. Contact Larry Nebron, 27 Garden Grove Drive, Daly City, CA 94015. (415/756-0735)

HELPING HAND: For sale. DX-150 receiver, needs some adjustment. Will sell for \$60.00 including frequency graphs and speaker. Shipping extra. Also, have Hallicrafters S-40B, also needing adjustments for \$30.00 plus shipping. Contact Frank Aden, Jr., 1535 N.W. Ithaca Avenue, Bend, OR 97701.

HELPING HAND: For sale. Sony ICF-5900W with manual, mint condition. \$100.00 including shipping. Contact Larry Brookwell, 1826 Cypress, San Diego, CA 92154 or call 714/429-9728.

HELPING HAND: For sale. Sony ICF-5900W, excellent condition. Just \$85.00. Contact Steve Handler, 445 Sheridan Road, Highland, IL 60040 or call 312/433-2802.

# log report *section* **D**

David L. Walcutt, Editor

11701 khz. & above

MARCH, 1978

- 11705 AUSTRALIA RA-Shepparton; 1101 EG, sport & mixed mx (Cucura 2/1).  
11705.1 CHILE VOC; 0210-0230\* EG, lies about Chile being propagated around the world by communists led by Moscow (Earhart 1/21). Fqy: DLW 2/21.  
11705 GUAM KTWR; 2215 EG, listed in Japanese but was in English with "Back to the Bible"; QSL info at 2242; poor (Zilmer 1/15).  
11709.7 ARGENTINA RAB; \*2300-2355\* EG to N.Am., mx & nx (6 reporters).  
11715 USA? VOA-unid. site; \*0500 EG, "Breakfast Show"; not listed in VOA schedule but suspect US site; good (Bishop 1/30). Cf. 15200 -ed.  
11720 AUSTRALIA RA-Shepparton; 0800-0839 EG, "Report from Australia"; fair level (Leithner 1/29, E.Miller 1/29).  
11720 CANADA CBC N.S.; 2230-2300 Eskimo/EG/FR w/pops (Thompson 1/28).  
11725 AUSTRALIA RA-Shepparton; 1942 EG, "Rhapsody in Blue" played pop style, with commentary by 2 men (Bryan 1/15).  
11725 CUBA RHC; \*0100-0115 EG, Cuba & world nx (Miller 1/27, Cucura 1/10).  
11730 GREECE VOG; 1225 EG, news & Greek mx, full ID, //15345 (McMullen 1/22).  
11730 USSR RSP&P; 1332-1345 EG, on Sadat-Carter meeting (Earhart 1/29).  
11730 MALAGASY REP. RN-Talata (Tanarive); 2000-2021\* FR and into \*2030 EG w/nx & DX Jukebox; fair (Burke 1/19); 2025-2045 EG, "Happy Station Show" and Andy William's song (Welch 1/8); 2030 EG w/"Happy Station Show" pre-recorded from 1/2/78, mx from "Mission Impossible" TV series (Bryan 1/15); 2040-2120\* EG, "Afroscene" (McCants 2/1).  
11735a SEYCHELLES FEBA; 1755-1807 unid lang with Int. Sig.; good level (Bohke 2/3). NP? Not in current sked -ed.  
11740 AUSTRALIA RA-Shepparton; 0855-0910 EG, mx, chatter (McCants 1/16).  
11740 HOLLAND RN; 2026-2035 EG, IS, ID, nx (Welch 1/21).  
11740 MALAGASY REP. RN; 1502 EG, "Cloud 9" with Bruce Parsons (Welch 2/4).  
11745 ECUADOR HCJB; 1215-1325 EG, gospel (McCants 1/10, Welch 1/18).  
11755 FINLAND RF; 1335-1340 EG, Nordic nx & cmnt; fair (E.Miller 1/26).  
11755 LEBANON R. Beirut "Radio Nacional de Liban"; 0020 AR with Arabic vocals; 0030 s/on anmts in SP by W for pgm to S.Am; nx until 0040 into SP & AR vocals; 0045 ID by W and ID; information about Lebanon until s/off and band NA at 0058; splash from Cuba (Hywarren 1/18).  
11755 SEYCHELLES FEBA; \*0300-0318 IS/ID into Farsi (Cunningham 2/2).  
11745 USA VOA-Bethany; 2330-2345\* SP, nx reports (Brouillette 1/19).  
11760 CUBA RHC; 1622-0000 SP (Leffler 1/22, Cucura 1/8, Brouillette 1/19).  
11770 ASCENSION IS. BBC W.S. (Afr. Alt.); 1705-1712, nx w/detailed items about Ethiopia; poor due to QRM from 11760 (Burke 1/14).  
11770NF AUSTRALIA RA; \*1757-1815 EG, new European Svc. via Carnarvon; s/on with Kookabura doing its thing (McMullen 2/5); 1810-1825 EG, world nx, pop mx (Bohke 2/3); 1855-1900 EG, s/off to UK (Hynes 2/2).  
11770NF IRAN VOI; 0430 (FS? -ed), Tehran heard here, //11745, 9022; 11745 is also new (Willis-AUST nd).  
11770 NIGERIA VON; 1800-1830 EG, Africa nx, songs (Cunningham 1/15); 1804 EG, gospel pgm w/African mx & accent (Greenes 1/15); 1850-1910 English, cmntry, ID, Nigerian nx, music program (Golkin 1/14).  
11775 ANTIGUA BEC W.S.; 1300-1330, world nx, "24 Hours" (Torsay 1/25). You reported this on 11750, but that is Far Eastern Relay at 1300! -ed.  
11775 INDIA AIR; 1050-1100\* EG, Middle East cmntry (Cucura 1/22).  
11780 NEW ZEALAND RNZ; \*0515 EG, mx w/Frank Chacksfield & Orch (Burke 1/14); 0700-0720 EG, old soap opera "Night Beat" (E.Miller 1/30).  
11780 USA WYFR-Okeechobee; 1951-2010 EG, "Health Tips", severe QRM (McCants 1/16); 2000-2030 EG, hymns & Bible readings (Buras 1/22); 2010-2050\* EG, rel. pgming, ID, s/off (Alexander 1/14).  
11790 USSR R. Kiev; 0040 EG, mailbag, //11690, 7150, 7215 (Yajko 1/15).  
11792 COLOMBIA R. Nacional; 0330 SP noted with Indian tabla/sitar mx(!), 0300-0330, ancs "Second Program"; 4955 inaudible at the time (Magne).  
11800 SEYCHELLES FEBA; 0414 EG, barreling in with gospel programs, giving Nairobi address only. The uninformed might well assume the station broadcasts from Kenya! (Hauser-TN 2/5).

- 11800 SOUTH AFRICA R. RSA; 1700 EG, on "New Nation" of Botswana (Turner 1/18); \*2100-2110 EG to W.Afr., Europe with nx, etc. (E. Miller 1/29).
- 11805 BRAZIL R. Globo; 2336 PT, ID's, ads (Yajko 1/13).
- 11805 USA WYFR-Scituate; 1905-1934 EG, "Unshackled", mx (McCants 1/24).
- 11810 ANTIGUA DW Caribbean Relay; 1330-1350 GM, news (Torsay 1/25).
- 11810 CHILE VOC; 1115 EG, ID, mx w/usual talk, //11920 (Cucura 2/3).
- 11810 INDIA AIR; 1400-1500 EG, pgm consisted of Indian mx (BEAUTIFUL!), cmtry, nx at s/off at 1500; a real treat for me since I'm rarely able to be awake at this hour (Conrad 2/3); 1400 EG, W with nx of visit of Irish Prime Minister (Osterman 1/27); 1420-1432 EG, mx, news and ID by M; poor (Cucura 2/1).
- 11820 ASCENSION IS. BBC W.S.; 1730-1915, "Book Choice", "Outlook"; 11750 is clearer (Swanson 1/27, Blossom-OH 1/23). 11750 is direct from UK 2000-2115, unlike this frequency which is a relay; but 11820 does an excellent job of filling in the gap between 1745-2000 for W.S. coverage in N.Am. -- even though 11820 is beamed to S.Africa -ed.
- 11835 VATICAN VR; \*1504 EG to India & S.E.As. with IS, ID (Conover 1/21).
- 11845 SEYCHELLES FEBA; \*0345 EG, IS, ID, poor (Conover 1/14); 0400-0410 unid. lang.; signals at least as good as 9770 at 1730+ (Conrad 2/3).
- 11850NF SWEDEN RS; 0230 EG, nx, SCDX'ers; replaces 11705; poor (Zilmer 2/2); 0240-0300 EG, best signals from Sweden in months! (but try 17790 at 1400! -ed.) (Conrad 2/4); 0253 EG, talk on religion in Sweden (Grenier 2/4). This freq suffers from co-channel QRM -ed.
- 11850 SWITZERLAND SBC; 2100 EG, to S. America with nx; fair (Zilmer 2/4).
- 11854.7 SAUDI ARABIA BSKSA; 1910-1952 EG, light mx & rock, TC (Cucura 1/22).
- 11860 LIBERIA ELWA; 2045 EG, on the meaning of love; fair (Yacono-NY 1/17); 2114 EG, gong, drumbeat, news summary (Greenes 1/25).
- 11860 USSR RM; 1628 EG to S.E.As., drama on Russian Revol. (Leffler 1/22).
- 11865 ANTIGUA Deutsche Welle; 2125-2150 PT, with IS, ID, nx, vocals & mx; site ID in English (Thompson 1/31, Anderson 12/30).
- 11870 AUSTRALIA RA; 1800-1900 -- look for new SSB xman to Europe here! -ed.
- 11880 CANARY IS. REE (Radio Exterior d'Espagne/Spanish Foreign Radio -- please note they no longer use RNE/RTVE/VOS/SNR; cf. 6065 -ed.); 2113-2208 SP, Spanish music, interview (Bohlke 1/23).
- 11880 SPAIN REE (Spanish Foreign Radio); 0130-0200 EG, on steel exports (Cucura 1/17); 0200-0208 EG, M&W, mx, time pips; het, bad level (Berezowski 1/26); 0230-0245 EG, M&W ancrs, news (Wineland 2/3); 0230 EG, news, interview (Torsay 1/27); 0307-0350 EG, "Folk Corner" new and music (Ponder 1/14). Note new ID -ed.
- 11885 URUGUAY SODRE; 2330-2358\* SP, "Noticias de Pais" all strictly cmtry, ID for Uruguay heard many times (Burke-FL 1/13).
- 11895 NORWAY R. Norway; 1800 EG, news & weekly events in Norway (Wright 1/22); 1800-1830 EG, about oil industry (Plambeck 1/22); 1801-1830\* EG, news & views, classical mx and talk; poor (Cucura 1/22).
- 11900 AUSTRALIA RA; \*1500 EG, ID and station location (you mean site ID? or just Australia? -ed) (Conover 1/14); 1700 EG, nx (Hynes 1/11).
- 11900 SOUTH AFRICA R. RSA; 2018 FR (Bryan 1/15); 2330-2320 EG (Hynes 1/11, Bohlke 1/25, McCants 1/21, Brouillette 1/14); 0457-0505 FR, with IS, ID's in English & French, into FR program (Howard 1/29).
- 11905 GERMANY W. DW; 0610-0627 EG, "African Service" with "News, views, and interviews of the world"; poor, QRM from 11900 RSA (Howard 1/31).
- \*11906.0 IRAQ "R. Baghdad, the BS of the Iraqi Republic"; 0300-0400 EG to N.Am., here since 1 January per BEC M.S., but only audible one day here so far; English pgm reminiscent of R. Tirana with vituperative anti-Sadat cmtry and only references to Israel as the "Zionist entity"; irr. QRM Greenville 11905; 500 kw. (Magne nd); 0301 EG, in new English service to N.Am; said it is a repeat of 2130; poor with het, but should be very good in spring & summer (Hauser 1/21); 0308 EG with local nx, Mid-eastern mx, echo ID, pgm on ancient art and on a Palestinian festival, pop mx; poor with heavy flutter (Alvi 1/1); 0345-0355 EG, "presented to you from R.B., the Broadcasting Service of the Iraqi Rep."; Arab music (Howard 2/3). 0645 unid lang, talk & mid-East type music; poor (Uerlings-OR 2/2).
- 11920 IVORY COAST R. Abidjan/RTVI; 1845-1915 EG, African mx, nx; poor (Burke 1/19); 2025-2333 FR, ID's with lion's roar, chanting & lcl mx, chanting & drums; piano mx, pops, talks (Bryan 1/15, Thompson 1/31, Yacono-NY 1/26, Tiers 1/15).
- 11925 BRAZIL R. Bandeirantes; 2331 PT, ads, ID, Brazilian vocals (Yajko

- 1/13); 0350-0402 PT, music; poor (Earhart 2/5); 0210, Brazilian music, many IDs as "Bandeirantes, Brasil" (Word-GA nd).
- 11925 GREECE VOA-Kavala; 0610 EG, "African Safari"; poor (Bishop 1/17).
- 11935 PORTUGAL RP; 0500 EG, pgm about the 1977 musical scene in Portugal with some beautiful Schubert played throughout the pgm (Burke 1/12); 0505-0515 EG, developing trade in "non-traditional" markets; "Sand & Sea"; broadcast schedule; good (Welch 2/3).
- 11940 BELGIUM BRT; 1727 EG, "Today in Belgium" roundtable (Burke 1/19).
- 11940 SINGAPORE RS; 0300-0400, heard daily, generally on 11942 actually but not Phnom Penh. Listed 0400-0500 (Willis-AUST).
- 11942 CAMBODIA Phnom Penh R.; 1500\*, heard once again (Willis-AUST).
- 11945 SEYCHELLES FEBA; \*1415 Urdu, after another language had finished; //15325 (Willis-AUST nd); \*1527 EG with IS, ID (Conover 1/21).
- 11955a PHILIPPINES R. Veritas; 1300 with IS, 11956, no other freqs noted (Willis nd); 1307-1325 EG with ID and "Our Changing World" and "Music of Asia" (Kuala Lumpur folk songs) (Howard 2/2).
- \*11955NF ANGOLA R. Nacional; \*0400 s/on with ID, long NA, ID again in Portuguese by W, fqs given, listing of day's pgms (Magne). Thanks to Larry's report I heard this: 0356 IS with heavy HCBJ splatter; 0435 "R. Nacional"; good after HCBJ off at 0500; appeared to have xmttr trouble as off 0532-0539, then back with calisthenics: "1,2,3,4"; then sputtering sound and off again at 0550 (DLW 2/21).
- 11960 PORTUGAL DW-Sines; 1825-1830 PL with ID (Plambeck 1/15). Site is per BBCMS (BEC Monitoring Service schedule) -ed).
- 11960 USSR R. Station Peace & Progress; 1320-1328\* EG, evidently beamed to Asia in view of cmntry (Earhart 2/7); 1310-1320 EG with nx, ID & cmntry on Vietnam (Cucura 1/8); 1545 EG, nx, cmnt (Leithner 1/11).
- 11990 CZECHOSLOVAKIA RP; 1745-1800 EG to Asia & Africa (Plambeck 1/22); 1805-1826\* EG, on nation & politics, EZ-listening mx (Blossom 1/27).
- 12060h USA AFRTS via VOA-Bethany; 2315-2330 EG, primary 6030 (Conrad 2/5).
- 12085 KUWAIT RK; \*1700-1820 EG, rock mx & cmntry (6 reporters).
- 15009a VIETNAM VOV; 1224-1258\* unid lang with music, talk (McCarthy 2/3); 1435 VI, tlk by W, strong signal (Kenyon 2/3).
- 15060 CHINA RP; \*0100-0310 EG to N.Am., usual (5 reporters); 0905 EG, letterbox program by W; fair/poor (E.Miller 1/29).
- 15084 IRAN VOI; 1610 FS, world & Mideast nx involving Sadat (Yacono 1/24); 1610-1624 Parsi, talk by M, fair/poor (McClure 1/17).
- 15100 LIBYA People's Revolutionary BS; 1355-1600\* AR, Arabic music (Alexander 1/20, Yacono 1/24, Willis-AUST nd, Earhart 1/21).
- 15104.4 GREENADA R. Grenada; 1955-2202\* EG, fascinating lcl pgm (12 reports).
- 15105 FINLAND RF; 1300-1330 EG, music & features (5 reporters).
- 15105 JAPAN NHK; 2156-0318 EG/JP, nx, "Current Topics" (6 reporters).
- 15105 MALTA Deutsche Welle; 2232-2303 PT to L.Am., mx (Earhart 2/6).
- 15117 PHILIPPINES R. Veritas; 1300 with English ID, //11955; and at 0130 EG with ID, //11725 (Willis-AUST).
- 15120 NIGERIA VON; 1800-1910 EG, features & pop mx (5 reporters).
- 15125 PORTUGAL RP; 1606 PT with sports match to Brazil (Lefler 1/22).
- 15129.8 CHILE VOC; 2310-0220 EG/others; historical cmntry (7 reporters).
- 15140 USSR RSP&P; 1330-1356 EG, tlks on Communism, etc.; good (Miller 1/29). R. Moscow; 0025-0035 EG, excerpts from Pravda (Bohlke 1/18).
- 15145 BRAZIL R. Jornal do Comercio; 0110-0227\* PT, on past regular s/off with sports event; ID at 0200; good (Howard 1/30).
- 15145 PORTUGAL R. Free Europe; 1730-1800 PL, rock mx (mostly Pink Floyd); ID given at 1800 "Rozlosnia Polska Radia Wolna Eur." (Cunningham 1/20).
- 15150 ANTIGUA Deutsche Welle; 1300-1311 GM with ID in EG (Cucura 2/2).
- 15150 CANADA RCI; 2130-2200 EG, Afr. Svc., news, tlk... (Torsay 1/25).
- 15155 SOUTH AFRICA R. RSA; \*1759-1830 GM (McClure 1/19, Cucura 1/8, Lefler 1/28); 2100-2320 EG (Thompson 1/25, Torsay 1/25).
- 15165 DENMARK RD; \*1200 DN with IS and ID in EG, "This is R. Denmark, Shortwave Dept., Copenhagen"; good (E.Miller 1/29); \*1730 EG with ID (Weinhold 1/22).
- 15167 BRAZIL Ceara R. Clube; 1940 PT, Brazilian pop & MOR music, ID's, time check GMT minus 3 hours; only 19 meter Brazilian (Bishop 1/11).
- 15169v ALGIERS RTVA; 1345 AR with ID; 15168/15171 (Willis-AUST).
- 15175 GUAM KTWR; 2158-2246 IN with ID's in English, gospel (7 reporters).
- 15175 NORWAY RN; 1400 EG, Joan Baez feature (Turner 1/18); \*1400-1430\* EG to N.Am., nx, folk mx, cmntry on North Sea oil; good (Fraser 1/8); 1400-1415 NO, EG "Country Roads" (Welch 1/18); \*1600-1605 EG, nx, etc.; fair signals with slight QRM (E.Miller 1/29).

- 15180 MALAGASY REP. RN relay; \*1728 DT with IS and ID (Conover 1/21).  
 15190 CONGO RTVC; 1832-2240 FR with EG at 2130 (6 reporters);  
 2130 EG with the "10:30 News" (Wright 1/15).  
 15195 JAPAN NHK; 0130-0230 EG, nx, "Current Topics" gave answer to my  
 question on farming and ranching in Japan; 0230 SP (Thompson 1/29).  
 15200 FRANCE RFI; 1700-1704 EG, theme song: "Voice of Spring" (Bryan 1/19).  
 15200 USA VOA; USB feeder, unlisted freq, carrying "Dateline" interview  
 with ambassador. Fair. (Brookwell 1/31).  
 15220 HOLLAND Radio Nederland; 1837 Arabic, news (Leffler 1/28). So?  
 15220 MALAGASY REP. RN; 2040-2100 EG, Tom Meijer's "Happy Station"  
 (Blaise 1/29); 2116-2131\* EG, no site ID at s/off (Hermann 1/25).  
 15250 ROMANIA RB; 1300-1330 EG, nx, cmntry (Cunningham 1/22). //11940 -ed.  
 15260 IRAN VOI; 1400 Persian?, very nice mx; fair, //15084 (Zilmer 1/21).  
 15260 JAPAN AFRTS FEN (Tokyo); 0900 nx, //6155 (Willis-AUST nd).  
 15270 JAPAN NHK; 2345-0045 EG into SP at 0045; to Americas (7 reporters).  
 15275 AUSTRIA ORF; \*1230-1245+ EG to N.Am., s/on into nx; operetta Der  
 Fledermaus; fair (Yajko 1/17, Zilmer 1/21); 1255 EG, ORF has final-  
 ly wised up like Switzerland, Finland and Sweden, and started beam-  
 ing our way in the mornings; heard on tip from Zilmer (Hauser 1/28).  
 15280 USA KGBI; 2330 SP, classical & MOR mx, nx headlines (Fraser 1/19);  
 0055 SP with religious pgms, ID, and more religious pgms (Baum 1/12);  
 0054-0057\* SP, address & ID, then off (Brouillette 1/9).  
 15290 PHILIPPINES VOA-Tinang; 2345 EG, "Breakfast Show", g (Bishop 1/19).  
 15300 ECUADOR HCJB; 1930-2030 EG, "Passport" etc. (Torsay 1/26, McCants  
 1/26, Cucura 1/8); 2100-2130 GM, religious pgm (Torsay 1/25).  
 15305 SWEDEN RS; 1230-1257\* EG to N.Am. (Prath 1/22, Fraser 1/20).  
 15305 TAIWAN VOFC; 0128 EG with English/Chinese lessons (Yajko 1/14).  
 15307.7 GUINEA R. Nationale; 1330-1500+ African lang., African mx & sing-  
 ing; no ID heard; poor (Fraser 1/14); 1245 Conakry heard fading in;  
 incredible reception through 1900; W.Afr. stations like this usual-  
 ly don't fade in until 1800 (Willis-AUST nd); 1402-1410 FR, high-  
 pitched singing (Earhart 1/18); 1825 FR, M with African tribal mx  
 & anmts; fair (Uerlings-OR 1/28); 2142 FR, African chants and music;  
 heard ID by M; fair (Yacono-NY 1/18).  
 15350.0 LUXEMBOURG Radio-Tele Luxembourg; 1544 FR, mx -- rock & roll style  
 (Leffler 1/22); 1745+ FR, US pop mx, M DJ, ads, ID (McClure 1/17).  
 This station was back on channel as of 2/14, and listening since  
 then I am sure it is stronger than before. With Zaire now gone  
 from this channel and 19 meters about where it was 3 years ago,  
 this can be heard all day with fine signals. Now is the time to  
 hear it, before a 500 kw. monster takes over the frequency! -ed.  
 15350 USSR RSP&P; 1445 EG with ID & nx on Africa; poor (Uerlings-OR 2/2).  
 15360 FRANCE RFI; 1700 EG, news, host John Abrams (Turner 1/18); 1706-  
 1800 EG, music, "Paris Calling Africa" (Weinhold 1/22).  
 15365 AFGHANISTAN RA; \*1200 in foreign service (Willis-AUST nd).  
 15400 ASCENSION IS. BBC W.S.; 1724-1744, modern Afr. history (Cucura 1/8).  
 15400 ITALY RAI; 1853-1905\* IT with English mx and ID (Cucura 1/29).  
 15400 VENEZUELA R. Nacional; 2200-2300 EG, music & news (Torsay 1/25);  
 2205 EG, pop mx & a brief history of Venezuela; poor (Yacono-NY 1/18);  
 2335-2348 SP, female ancr with local songs; VOA QRM (Earhart 1/25).  
 15402 BANGLADESH RB; 0700 (language?-ed), nx; //17888 (Willis-AUST).  
 15420 ANTIGUA BBC W.S.; 2000-2030, "World News", "24 Hours" (Torsay 1/25).  
 15425 TAIWAN VOFC; \*2355-0140 EG, drama, Chinese lessons (5 reporters).  
 15440 FRANCE RFI; 1406-1425 FR with ID and music (Cucura 1/8).  
 15440 USA WYPR; 1750 EG, "Health Tips" (Swanson 1/27). France QRM -ed.  
 15445 USSR RM; 0000 EG, news (Torsay 1/25). To West Coast N.Am. -ed.  
 15520 CHINA RP; 0000-0015 EG with news & cmntry (Japan & Soviet Union,  
 China & its people) (Leithner 1/24, Welch 1/15, Woltman 1/22).  
 15520 PAKISTAN RP; 1250 Bangla, talk by M (Prath 1/14). See next!! -ed  
 15521 BANGLADESH RB; 1230 EG, good (Willis-AUST nd). QRM Pakistan? -ed.  
 17670 EGYPT R. Cairo; 1532 AR, end chants into two men screaming; usual-  
 ly a clear and strong sign (Sarrazin 1/15); 1608-1638 AR with ID,  
 Arabic music, and live sport event (Cucura 2/1).  
 17685 ISRAEL IBA; 1720-1730 Hungarian with news (Torsay 1/28).  
 17705 CUBA RHC; 1511 SP, on Jose Marti (Heroe Nacional) (Leffler 1/22).  
 17710 ISRAEL IBA; \*1400 Yiddish, jammed; poor; //21500 (Zilmer 1/28).  
 17710 NEW ZEALAND RNZ; 0030-0042 EG, relaxing MOR mx pgm; good (Howard  
 1/23); 0153-0210 EG, classical mx, 0200 time pips; gone by 0215

- (Blossom-OH 2/7); 0300 EG, 4:00 PM there, "Syncopated Clock" instrumental; ID by M, weather given (Bryan-CA 1/18).
- 11713.2 CHILE VOC; 2103-2115 EG; anti-Soviet Anti-Communist cmntry (Blaise 1/21); 2200-2230 GM; good signals (Limann-VENEZUELA 1/ ). Many thanks for your report Jack, which I was very happy to receive. You don't need to use your "Reception Report" forms, though, and lots of details about the programs of the stations you can hear from Venezuela would be especially useful to all of us. Hope to get many of your loggings in the future!! -ed. 0013 EG talk (Cucura 1/10).
- 17745v SWAZILAND TWR; \*1908-2015 FR, vernacular rel pgm 1915-1930; good (Krueger 1/14, Kenyon 1/29, Alexander 1/22).
- 17755 ECUADOR HCJB; 1600-1730\* EG, rel mx, Bible stories (5 reporters).
- 17775 FRANCE RFI; 1200-1700 FR, ex-17780; //15440 (Limann 1/ ).
- 17790 SWEDEN RS; \*1400-1430 EG to N.Am. with excellent sigs (7 reporters).
- 17800 CHILE VOC; 1236-1250 EG with ID, nx, mx & usual talk (Cucura 2/2).
- 17800 GERMANY W. DW; 1330-1350 GM to N.Am., nx, press report (Torsay 1/27).
- 17805 USSR-Armavir (European RSPSR) RM; 1625-1649 EG; pgm to Africa; Tallinn-Estonian SSR, per Roger Legge in TDXN #81. Fair (Krueger 2/1); 1644 EG, cmntry, African Svc.; is Tallinn (Phillips 12/25). However, in UHN #11 Roger Legge says he believes the xmtr for this is at Armavir, in southern European SSR; and I am inclined to go with this later opinion -ed.
- 17810a PHILIPPINES FEBC; 2342 EG, address of Friendship Club in Manila; poor (Osterman 1/26); 2357 EG, end rel pgm; good (Greenes 1/12); 0011-0030 EG, on snow in Japan & N.Y.; good (Howard 1/23); 0014-0032 EG with nx at 0030; faded (McClure 2/4); 0448-0500 EG, "Hobby of Kings" with Sydney Boyd (Wallace-JAPAN 12/25). Chess?
- 17815 BRAZIL R. Cult. de São Paulo; 2350-2359 PT, song with guitar, mention São Paulo; very poor but readable (Osterman 1/26).
- 17825 JAPAN NHK; \*0059 EG with ID; 0130-0230 EG to N.Am. (5 reporters).
- 17840 CZECHOSLOVAKIA RP; 1530 EG, nx, topics of the day (Torsay 1/26).
- 17845 USA Cf. February FRENDX; Arthur Thompson assures me WYFR does monitor their own signals off the air using type-approved equipment, Belare AMM-2 monitors. These have "straight demodulation", and the FM warble cannot be detected on them since there is no local oscillator to beat against. So it seems that WYFR is not to blame, but the FCC, for not requiring monitoring on an ordinary rcvr! (Hauser).
- 17855 GUAM TWR-KTWR; 0027 EG, "Through the Bible" pgm, ID at 0058, went & came back at 0100; best I've heard it (Wright 1/18); 0031 EG, religious sermon, good signal (Sarrazin 1/10).
- 17865h COLOMBIA La Voz de los Centauros, in Villavicencio; I think this is a test transmission; fair/good 1900-0500 SP (Limann 2/4-6). This must be a harmonic, 3 x 5955 (reported on 5954 actually) -ed.
- 17875 GERMANY Deutsche Welle; 1244\* EG to Africa, into Hausa (Richezza).
- 17900 VATICAN VR; 1644-1715\* FR/EG with Vatican nx (Bryan 1/19, Cucura 2/1).
- 17920 EGYPT R. Cairo; 1240 EG, news by woman (Prath 1/14).
- 19100h CUBA RHC; 15330 SP, 2 x 9550 (Cucura 1/22). 1/22).
- 21510 ITALY RAI; 1422 IT, with ID, mx, calcio minuti per minuti (Lefler 1/28).
- 21525 HUNGARY R. Budapest; 1414 GM with DX pgm; poor (Zilmer 1/28).
- 21535 SOUTH AFRICA R. RSA; 1424-1647 EG programs (7 reporters).
- 21540 GERMANY E. RFI; 1415 EG to S.E.As., on German economy (Prath 1/8).
- 21620 FRANCE RFI; 1432-1450 FR, sports, mx (Lefler 1/28, Richezza nd).
- 21640 NETH. ANTILLES RN-Bonaire; 2030-2120\* EG, Saturday Sound Studio, with Top 20 (Thompson 1/28); 2040-2100 EG, Tom Meijer with Japanese mx record! (Blaise 1/29); 2045 EG, "Happy Station" (Weinhold 1/22).
- 21700 PORTUGAL RP; 1226-1513 PT, local music, sports report, soccer game (Earhart 1/12, Lefler 1/22, Cucura 1/22).
- 21710 UK BBC W.S.; 1220-1226 EG, oldie songs such as "As Time Goes By"; fair (Earhart 1/12); 1440 EG, "Vintage Comedy -- take it from here (Lefler 1/22); 1445 pop music (Richezza nd).
- 21725 NORWAY RN; 1400 EG, news and comment (Prath 2/5).
- 23620h ANTIGUA DW; 1329 with IS noted, 2 x 11810 (Hauser-TN 2/4).
- 23780h USSR R. Moscow IS heard at 1330, 2 x 11890; jamming also audible on 23770 (Hauser-TN 2/4).
- 24140h USSR R. Moscow; 1332 AR, highly-produced program with M&W, bits of music; fade out before 1400, but at 1455 check back with "R. Staniya Rodina" pgm ending, giving meter bands for N.Am.; can't be sure both pgms from same xmtr, but both listed 12070 (Hauser 2/4).
- 25605 ISRAEL IBA; 1510 FR by M, poor (Abraham nd). Russian sked! -ed
- 2500h mis-sort: USA WTMA Charleston, SC; 2 x 1250 at 2300 (Alexander 1/14).



Distr. Editor: Greg Ravenhorst DEADLINE: 12th of month FIRM!

# FRENEX CREDITS

Rural Route, Hollandale, MN. 56045

Thanks go out to 88 reporters this month, including several new contributors, BUT, my deadline was the 13th, and I received 29 reports on the 14th & 15th. Thus, they did not make it into this issue, as I had sent everything on it's way to the respective Log Report editors. A deadline is a deadline, after-all! Those reports that got here late had been mailed on the 8th - 12th, so please get your contributions off in time! Reports received late were from: Batson, Bogel, N. Brown, Bunce, Cannon, D. Clark, Edelstein, Frajer, Fumelli, Goodman, Hardester, Hascall, C. Hoffman, Ihnat, D. Johnson, Jones, Levesque, Lobdell, MacKay, Matthew, McLaughlin, Overcamp, Petravick, Poppin, Sillings, C. Sherman, R. Smith, and Youndt. These reports will be in April.

Larry ABRAHAM, Bridgeport, MI (HQ-180A)... Brian ALEXANDER, Mechanicsburg, PA (DX-160)... Jamil ALVI, Saskatoon, Sask, Canada (Sanyo 16HA-862P)... Mike ANDERSON, Carlisle, KY (SSR1)... Ricky BAUM, Gainesville, FL (CRF-5100)... Rival BAYSA, Washington, MI... Robbie BEREZOWSKI, Calgary, Alta, Canada (DX160) Gerry BISHOP, Christina, PA (DX-160)... E.V. Sandy BLAIZE, Metairie, LA (51J3) Tom BLOSSOM, Austinburg, OH (SPR4)... Dale BOHLKE, St. Louis Park, MN (FRG7?) Larry BROOKWELL, San Diego, CA (SPR4)... Paul BROUILLETTE, Sault Ste. Marie, MI (DX-160)... Josephine BRYAN, Stockton, CA (FRG7)... W.C. BURAS, Metairie, LA (SSR1)... Arthur BURKE, Jr, Leesburg, FL (SPR4)... Michael CALDERWOOD, Denver, CO (DX-40)... Tony CLIFT, Campbellville, Ont, Canada (PYE-1101)... Jack CONOVER Lenexa, KS (SPR4/XCR30)... James CONRAD, Waterloo, IA (HQ160)... Vladimir CUCURA, Jr, Reading, PA (FRG7)... Larry CUNNINGHAM, Columbus, OH (DX-160)... Joe DELAP, Prairie Grove, AR (FRG7)... Kenneth EARHART, Allentown, PA (FRG7). Marlin FIELD, Hillsdale, MI (SPR4)... Robert FRASER, Cohasset, MA (XCR-30)... Gary GANS, Jerusalem, Israel (DX-160)... Editor Tom GAVARAS, Wayzata, MN (HQ180) Mark GODFREY, Bloomfield, CO (QR-666)... Jon GOLKIN, Glen Head, NY (DX-160).. David GREENES, Lynnfield, MA (FRG7)... Pete GRENIER, Azusa, CA (FRG7)... Harry HARTSELL, Lompoc, CA (FRG7)... Editor Glenn HAUSER, Knoxville, TN (FRG7/HQ160) Bob HAYES, Hillsdale, MI (SW4A)... Frank HERMANN, Kitchener, Ont, Canada (DX-160)... Hal HILLMAN, Barrington, RI (SX-99)... Bobby HOBBS, Rocky Mount, NC (FRG7)... Ron HOWARD, Santa Barbara, CA (SE-310)... Charles HUTCHINS, Rumford Pt, ME (FRG7)... Chris HYNES, Erie, PA (Zenith Oceanic)... Aaron HYWARREN, Winnipeg, Man, Canada (AR2A/ICF-5900W)... Don KENYON, Butler, PA (FRG7)... Terry KRUEGER, Casselberry, FL (QR-666)... Irving LEFFLER, Brooklyn, NY (SPR4) Chris LEITHNER, Brentwood, TN... Larry MAGNE, Philadelphia, PA (R4B)... William MANN, Brantford, Ont, Canada (SX-190)... Eric MILLER, Dorchester, MA (Zenith) Donald McCANTS, Tuscaloosa, AL (GE 10 band port/DX-160)... Dan McCARTHY, Kissimmee, FL (DX-160)... James McLURE, Lexington, KY (R390A)... Bill McMULLEN Ann Arbor, MI (DR-22)... John ONKEN, Metamora, IL... Sydney OSTERMAN, Toronto, Ont, Canada (FRG7)... Tom OVERCAMP, Seneca, SC (SP-600)... Bill PHILLIPS, Brewer, ME (XCR-30)... Wilder PICKARD II, Evanston, IL (FRG7)... Loren PLAM-BECK, Cloquet, MN (SPR4)... Stephen PONDER, Fort Worth, TX (GC-1A)... George POPPIN, San Francisco, CA (FRG7)... John PRATH, Ft. Lauderdale, FL (FRG7)... Edward PYATT, Conway, SC (XCR-30)... Ed RICCHEZZA, Philadelphia, PA (SW4A)... Kevin RINKER, Dayton, OH... Jim ROBERTS, Winnipeg, Man, Canada (Eddystone 940/FRG7)... David SARRAZIN, Denver, CO (NC-183D)... Brett SAYLOR, Altoona, PA (DX-160)... Herman SPEECE, Jr, Union Grove, NC (R392/RF2200)... Richard SWANSON, Wellman, IA (DX-160)... Leon TANNENWALD, New York, NY (SPR4)... Glenn THOMPSON, Deming, NM (HQ-145A)... Mike TIERS, W. Vancouver, BC, Canada... Eugene TORSAY, Pompano Beach, FL (FRG7/DX-160)... Jane TURNER, Charlotte, NC (DX-160)... Dave TWIGGS, Bristol, CT (DX-160)... Jim UERLINGS, Klamath Falls, OR (SX-130)... Robert WALLACE, Yokosura, Japan (CT-9505)... Terry WEINHOLD, Terre Hill, PA (ICF-5900W)... William WEICH, Tallahassee, FL (FRG7)... Mike WILLIS, Hampton, Vic, Australia (Trio 9R59DE)... Lynn WINELAND, Blacklick, OH (FRG7)... Frank WOLTMAN, Cambridge, WI (DX-160/FRG7)... Gerald WORD, Carrollton GA (FRG7)... John WRIGHT, Jr, Morristown, TN (DX-160)... Dominick YACONO, Brooklyn, NY (Zenith Transoceanic)... Robert YAJKO, Leechburg, PA (SPR4)... Robert ZILMER, Milwaukee, WI (SPR4/R390A)...

REPORT FORMS available for a large envelope and 28¢ in coin or postage. I'm back at Hollandale now. As luck would have it, I had to move in the midst of the month, the 15th, when I've just finished my deadline, and the house looks like an A-Bomb hit it. Visited the Manitoba guys on Feb 3-5th. I tip my headphones to them with thanks. DXing in a bus at -42! Interesting 173, *Shog*



# SPECIAL *feature*



## RUSSIAN TRANSMITTER SITES VERIFIED BY U.S. DXERS

TOTAL: 66

### EUROPEAN USSR: 21

Archangelsk  
Armavir  
Gorki  
Kalach  
Kalinin  
Kazan  
Kingisepp  
Konevo  
Kursk  
Leningrad  
Mitchurinsk  
Moscow  
Murmansk  
Orenburg  
Riazan  
Serpukhov  
Tula  
Ufa  
Vologda  
Voronezh  
Zhigulevsk

### BYELORUSSIA SSR: 3

Minsk  
Moghilev  
Orsha

### UZBEK SSR

Tashkent

### LATVIA SSR

Riga

### AZERBAIJAN SSR

Baku

### FINNISH-KARELO SSR

Petrozavodsk

### KIRGHIZ SSR

Frunze

### ARMENIAN SSR

Yerevan

### ASIATIC USSR: 20

Blagoveschensk  
Chita  
Irkutsk  
Kenga  
Khabarovsk  
Kanty-Mansiysk  
Komsomolsk-on-Amur  
Krasnoyarsk  
Magadan  
Nikolayevsk-on-Amur  
Novosibirsk  
Omsk  
Okhotsk  
Petropavlovsk-Kamchatka  
Sverdlovsk  
Tyumen  
Ulan Ude  
Vladivostok  
Yakutsk  
Yuzhno-Sakhalinsk

### TADZHIK SSR

Dushanbe

### GEORGIA SSR

Tblisi

### TURKMEN SSR

Ashkabad

### KAZAKH SSR: 2

Alma Ata  
Dzhambul

### LITHUANIAN SSR

Kaunas

### ESTHONIAN SSR

Tallinn

### UKRANIAN SSR: 9

Ivano-Frankovsk  
Kharkov  
Kiev  
Lvov  
Nikolayev  
Simferopol  
Starobelsk  
Uzhgorod  
Vinnitsa

### INACTIVE SINCE MID-60's

### MOLDAVIAN SSR

Kishinev (not included  
in the above totals)

### COMPILED BY:

ALVIN V. SIZER  
22 COUNTRY WAY  
NORTH HAVEN,  
CT 06473

(Edited frequently.  
Updates, additions  
and corrections are  
welcomed.)

I received a postal card from David K. Maxfield, Ann Arbor, MI with the following....

Question: What is a NASWA member's favorite nutrient?  
Answer: DXtrose, of course!

Who said vaudeville was dead?

*Bill*

# NASWA "UNITY AND FRIENDSHIP" ✱

PUBLISHES FRENDX MONTHLY

## NASWA MEMBERSHIP FEES:

First Class Worldwide.....	\$13
Airmail to Central America, Carribbean, South America, Europe.....	\$20
Airmail to Asia, Africa, Pacific.....	\$22

All remittances must be in U.S. funds and mailed to: NASWA, P.O. Box 13, Liberty, IN., 47353, U.S.A.

UPDATE: Besides FRENDX, NASWA also publishes UPDATE... a midmonth newsletter with the very latest DX news while it's still news. (UPDATE also appears in each issue of FRENDX). It is only available to NASWA members.

"UPDATE" SUBSCRIPTION RATES PER YEAR:

North America (First Class).....	\$3.
Overseas (Airmail).....	\$5.

Sample copies of FRENDX and UPDATE are available for \$1.00



EXECUTIVE DIRECTOR - Mac Leonhardt, P.O. Box 13, Liberty, IN., 47353  
CORRESPONDENCE SECRETARY - Alan Mayer, P.O. Box 321, Park Forest, IL 60466  
PUBLISHER & MANAGING EDITOR - William E. Oliver, 45 Wildflower Rd., Levittown, PA., 19057  
SHORTWAVE CENTER - Jerry Lineback, P.O. Box 325, St. Joseph, IL., 61873  
QSL REPORT - Sam Barto, 245 Cherry Ave., J-11, Watertown, CT., 06795  
UPDATE EDITOR - Tom Alleman, 615 W. 43rd Terrace, Apt. 6, Kansas City, MO., 64111  
SCOREBOARD - Myron Smith, 36 Ogden Center Rd., Spencerport, N.Y., 14559  
DISTRIBUTING EDITOR - Greg Ravenhorst, Rural Route, Hollandale, MN., 56045  
LOG REPORT (A) - Dan Robinson, 5004 Fulton St. N.W. Washington, D.C. 20016  
LOG REPORT (B) - Steve Wiseblood, 707 Loma Way, Santa Maria, CA., 93454  
LOG REPORT (C) - Tom Gavaras, 16920 17th Ave., N. Wayzata, MN., 55391  
LOG REPORT (D) - David Walcutt, P.O. Box 1051, Carbondale, IL., 62901  
LISTENERS' NOTEBOOK - Glenn Hauser, c/o WUOT, Univ. of Tenn., 232 C & E Building, Knoxville, TN., 37916  
AWARDS CHAIRMAN - Dan Henderson, 7921 Anfred Drive, Laurel, MD. 20810  
COUNTRY LIST CHAIRMAN - Don Jensen, 5204 70th St., Kenosha, WI., 53140  
U.K. REP - Alan Thompson, 16 Ena Ave., Neath, W. Glamorgan,

**FIRST CLASS MAIL**

NORTH AMERICAN SHORT WAVE ASSOCIATION  
POST OFFICE BOX 13  
LIBERTY, INDIANA 47353 U.S.A.

FIRST-CLASS MAIL  
U.S. POSTAGE  
PAID  
Levittown, Pa.  
Permit No. 319