

FRENDX

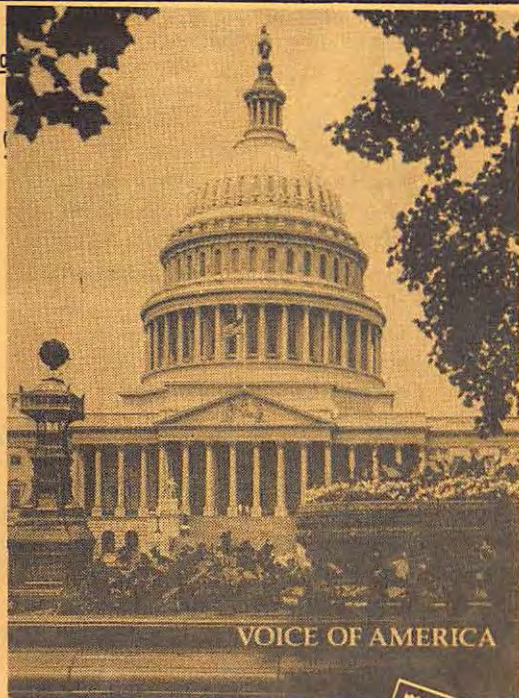

15 16 17 18 19 20 21 22 23 24
 OR1-100
 CHN



THE VOICE OF AMERICA
 WASHINGTON, D. C., U.S.A. 20547

Official Business
 Penalty For Private Use, \$300

We are pleased to confirm your
 reception of our broadcast of 2/8/78

from Tangier, Morocco
 on 9760 KHz 3025 GMT

Monica Yall
 (Signature)

Close-up view of the
 United States Capitol
 Washington, D.C.

9640 LAM GR-250
 9650 GR 250 TAN-100 DX-250 OC(UH)
 LAM EUR (UN)
 9660 SAM GR 500/500/50 250
 9670 SAM EUR
 9680 DL-250 MUN-100 NAF
 (BBC)



GR-250 EUR
 TAN-35 ME USSR

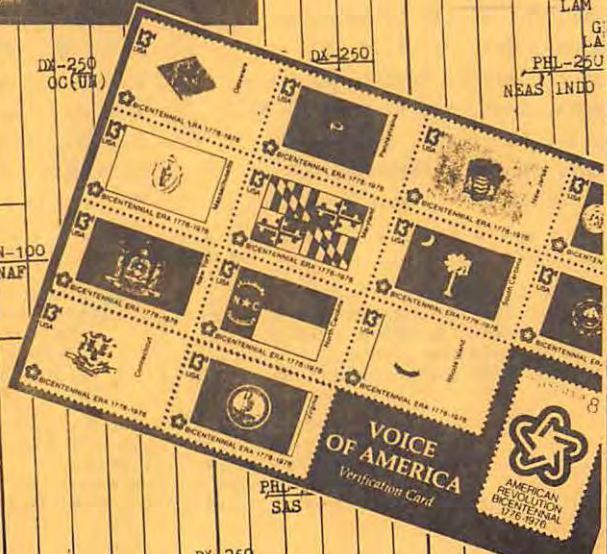

PHL-250 SAS

DX-250



ANDERSON, Eric, Greenfield, MA
 AYERS, Richard, Davisburg, MI
 BAILEY, Richard E., Dayton, OH
 BARTH, Offer, Haifa, Isreal
 BENJAMIN, Paul, Hats, KS
 BOOKER, DeLoss, Findlay, OH
 BOSWORTH, Paul L., Chillicothe, OH
 BROWN, Luther H., San Antonio, TX
 CADDEN, Tim, Glenview, IL
 CALDERWOOD, Michael J., Denver, CO
 CLARK, D.M., Scarborough, Ont.
 CLAWSON, Richard T. Largo, FL **
 COREY, James M., Athens, GA
 CORSON, George C., Waterloo, IA **
 D'ANGELO, David W., Broomall, PA
 DAWSON, Walter M., Milwaukee, WI
 DOYLE, W. Randall, Fayetteville, AK**
 DUBIN, Jeff, Philadelphia, PA **
 EPPS, Charles L., Costa Mesa, CA
 GRANT, Ian H., Rexdale, Ont.
 HAMILTON, Philip, Tucson, AZ
 HAYDEN, Sol, Brooklyn, NY
 HENRY, Calvin, Tucson, AZ
 HESSE, John, New Brunswick, NJ
 HIATT, Larry Joe, Denver, CO
 HUNT, Paul R., Savannah, GA
 HUTT, Glenn A., Boca Raton, FL

JACKMAN, Earle, Minneapolis, MN
 KEITH, Kit, Jr., Houston, TX
 KIRK, Jerry D., Tulsa, OK
 KLEIN, Peter A., Louisville, KY
 KREUTER, David, St. Paul, MN
 LAVIN, Robert, Norristown, PA
 LEBRYK, Thomas, Irvington, NJ
 LEITE, Keith, Fall River, MA
 LEITHNER, Chris, Brentwood, TN
 MCCURDY, Robert, Camp Hill, PA
 MAGAW, L.E., Camden, SC
 MERRIGAN, Shaun, Edmonton, Alta.
 MOXNESS, Alfred, St. Paul, MN
 NASH, Donald S., Rochester, NY
 O'CONNELL, Ronnie B., Richmond, VA
 PADGETT, Earl C., Kansas City, MO
 REYNOLDS, Al, Beckley, WV **
 RINKER, Kevin, Dayton, OH
 SALAY, Michael J., Cincinnati, OH
 SYLVESTER, Shawn, Houston, TX
 TENCATE, Bob, Seattle, WA
 WEINBERG, Sheldon B., New York, NY
 WHEELER, Donald R., Bay Village, OH
 WHEELER, Lawrence, Minneapolis, MN
 WIRRELL, Robert, Brockton, MA
 ZABRANSKY, Jim, Abra, Philippines **
 ** Nice to have you back as a member

 DX LIMERICKS

A DXer I know named Brock,
 Thought lightening arrestors a crock,
 But when a storm came around,
 He suddenly found,
 His rig made an excellent door stop

Ex-President Richard M. Nixon,
 Settled to do some serious DXin',
 He turned and said to Pat,
 "How about that!,"
 I've just logged VOA, Dixon."

A hot tempered DXer named Bill,
 Wrote for veries to show off his skill,
 But his anger did arise,
 When he got no replies,
 Now, they're reading the Post Master's will.

NASWA

A REPORT FROM
HEADQUARTERS

NORTH AMERICAN SHORT WAVE ASSOCIATION POST OFFICE BOX 13 LIBERTY, INDIANA 47353 U.S.A.
FEBRUARY, 1978

HQ NOTES: As this is being written, here in eastern Indiana, we have 23" of snow on the ground, and more coming down at the moment. We hope we are able to get this to the Post Office in time for it to get to Bill Oliver in time for the February FRENEX.

This issue is the first to be published and mailed from our new location, that being Levittown, PA. New publisher Bill Oliver, assisted by other area NASWA members Jon Cohen and Nick Pappas have been working for some weeks to arrange for the transfer. We might also mention that we have invested almost \$1,000.00 in new addressing equipment in the interest of improving the reliability of getting each member his/her FRENEX and Update without fail and on time. The old addressing machine, which has seen it's better days, has been donated to the Chicago Heights (Illinois) Salvation Army for their future use. The continued support by the NASWA membership makes this progress possible, and we thank you.

1978 WRTH OFFER: Word from NASWA member Donald Erickson informs us that he is able to offer NASWA members the 1978 World Radio-TV Handbook (WRTH) at a special price for a limited time only at a price of \$9.00 postpaid by book rate mail and within the U.S. only. Better yet, if you are under 18 years of age, or over 18 and have never owned an earlier WRTH, the price is just \$7.00. Each order must specify NASWA membership and payment be made by check or money order, plus as SASE for confirmation of shipment. Regular price is reported to be around \$12.00.

Send orders direct to Donald Erickson, 6059 Essex Street, Riverside, CA 92504 and allow several weeks for delivery. NASWA is not involved in this other than to announce the offer, so all inquiries and orders should be sent as soon as possible to the address given, not HQ. We do appreciate his making the special offer available to our members.

BOY SCOUT MERIT BADGE COMMITTEE ESTABLISHED: The December issue of FRENEX commented on the fact NASWA was establishing a committee to work with the National Office of the Boy Scouts to assist in updating their Radio Merit Badge requirements to include the area of SWL.

Chairman Roger Peterson, New Canaan, CT, reports the committee has been finalized with the addition of NASWA members Harold C. Rowan, Jr. of El Dorado, Arkansas and Kent Corson of Dubuque, Iowa. We thank these gentlemen on offering their services, and will look forward to further reports on the progress of this worthwhile project.

PANASONIC ADDS TWO NEW SW RECEIVERS: NASWA member Daniel Stolz, who is also National Sales Manager, Radio/Two-Way Communications, for Panasonic Divn. of Matsushita Electric reports Panasonic's new "Command Series" International shortwave receivers will be on the U.S. market during February, these being in addition to their current popular RF-2200 model. The new RF-2800 and RF-4800 receivers feature five digit LED readout display plus a number of other desirable features. The RF-2800 will retail at approximately \$249.00 and the RF-4800 at \$449.00 (about \$20.00 higher, each model on the west coast). For a handsome free six page brochure, write to David Stolz, Panasonic Company, One Panasonic Way, Secaucus, NJ 07094 and request the "Command Series" folder.

MORE ABOUT THE SLINKY DIPOLE: This new item mentioned in the December issue of FRENEX has prompted a number of inquiries about it. Todd Graves of SWL Guide, 414 Newcastle Road, Syracuse, NY 13219 offers a free pamphlet and an article with additional information and will quote prices for supplying this item to those interested. Write to the address given.

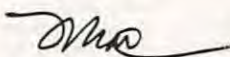

M. R. Leonhardt
Executive Director - NASWA

Shortwave Center



JERRY A. LINEBACK, EDITOR
P. O. Box 325
St. Joseph, Illinois 61873

February 1978

A special and warm welcome to all new FRENEX readers and NASWA members this month. We hope you will find information here that will help you enjoy the hobby of listening to shortwave radio broadcasts. Shortwave Center needs your support. We solicit articles on any aspect of shortwave broadcast radio. Please send your contributions to the SWC editor, address above. The usual deadline is the 10th of the month to insure inclusion of timely material. But send articles at any time.

RADIO 5

"GOOD VIBES FROM RADIO 5"

by Pitt McNeil, Washington DC

To understand the *raison d'être* for Radio 5's existence, there is a need to give a partial history of commercial radio in South Africa.

The story starts out in the unlikely place of Portuguese East Africa in 1935. That was the year Lourenco Marques Radio, the commercial service of Radio Clube de Moçambique, first came on the air, beaming primarily to the Union of South Africa. Although LM Radio's commercial activities were somewhat curtailed by World War II, things really started moving in 1947, when Davenport & Meyer Ltd., a Johannesburg-based company, took over the station's programming policy and the sale of advertising time, at the request of the sole concessionaire to the Radio Clube, one G. J. McHarry.

During the following two decades, LM Radio succeeded in becoming not only a commercially successful enterprise, but also in making its announcers into household names throughout southern Africa. A list of past LM announcers sounds like a "Who's Who" of South African broadcasting. The likes of Eric Cordell, Eric Egan, David Davis, and Clark McKay are but a few of the "extremely well-known" personalities who have added sparkle to LM Radio programs over the years.

Between 1947 and 1967, the LM Radio format consisted of music for all tastes, comedy shows, and dramas - in fact a mixed bag designed to attract as wide an audience as possible. But in the face of increasing competition from Springbok Radio, and several RSA FM stations, a decision was made to alter the program policy in order to attract a main target audience of young people between the ages 16 and 24. This new policy meant that in 1968 the station began its "Top 40" format, involving continuous pop music with a minimum of talk, for 24 hours a day, seven days a week. A major reason for the change to Top 40 was to combat the threat of television taking over radio audiences. The new format was highly successful too, and the station's audience profile changed accordingly, with over 75% of its audiences falling within the 16-24 "young adult" bracket. With South African advertisers becoming more and more aware of the vast potential of the youth market, the economic viability of LM Radio was assured.

In June, 1972, the SABC took over the responsibilities of the sole concessionaire. The station was then headed by Roland L. Boshoff in Johannesburg, with a staff including the manager, organiser, sales and administration working with him. The LM based staff included Gerry Wilmot (station manager), Evelyn Martin, Harold West, and Frank Saunders.

During 1973, the station introduced two new 120 kW transmitters, on 41 metres daytime, and 90 m at night. The introduction of these two powerful transmitters augmented the already formidable battery of equipment operating on the 25, 39, 49, and 60 metre bands on shortwave, as well as LM Radio's high quality MW transmitter.

The next major step for LM Radio was on 1 January 1975 when LM Radio's shortwave transmissions were relayed by SABC MW stations in six South African cities, giving their listeners daytime MW reception for the first time.

In late 1975, Mozambique was granted independence from Portugal. Soon afterwards, the SABC was informed that the facilities of the Radio Clube de Moçambique would be nationalized by the new government.

Conscious of the tremendous popularity of LM Radio, the SABC made advance plans to continue the Top 40 contemporary music format. At 5 a.m. on 13 October 1975, over the MW stations in South Africa that formerly relayed LM Radio, a new national network was born: Radio 5. Radio 5, so named as the fifth commercial radio network of the SABC, "but retaining the best of LM Radio and moving on to greater listener acceptance as a new sound from the SABC," as Radio 5 promos said, was thus started.

It was always realized that with the existing MW transmitters, many listeners could only hear Radio 5 with sub-standard night time signals. Accordingly, on 1 August 1977, a 100 kW SW transmitter was brought into service, operating on the 49 metre band daytimes and on the 90 metre band at night.

"With these improved facilities and aggressive programming, including the coverage and participation of Radio 5 in motor rallying with the famous Radio 5 Ford Escorts, it will be seen that Radio 5 has more than held its own against television and will continue to do so in the years ahead," according to Pietie Lotriet at Radio 5.

Radio 5 now features LM Radio DJs along with SABC announcers, including John Berks, John Novik, Harold West, Steve Katz, and SABC's own "Forces Sweetheart" Marie van Zyl.

From 6 November 1977, the schedule for "Good Vibes from Radio 5", as the station slogan goes, is as follows: 3320 kHz at 0300-0530 and 1530-2200; and 7170 kHz at 0530-1530 GMT. Reception reports from DXers are welcome; no return postage is necessary. Address them to: Senior Engineer, (Panorama), Radio 5, P. O. Box 4301, Johannesburg 2000 Republic of South Africa.

(The author thanks Robert E. Edwards at Radio 5 for the background information on Radio 5 and LM Radio. This article first appeared in Tropical DX Newsletter, Fred Heutte, Jr. Prop., on 20 December 1977.)

NASWA DX AWARDS NOTES

DX AWARDS

by Gerry Bishop, Christiana PA

THE NIGERIAN AWARDS: These are two awards that I'm working on at present, and have found them to be quite easy to get, but this ease is due, I'm sure, to the frequency of times that the Nigerians are audible here. On any given day there are usually three or four and on a good day four or five Nigerians may be heard from almost anywhere in the U.S. and Canada.

My log shows that the first week of May 1977 was an excellent week for reception from west Africa, particularly from Nigeria. I took details for as many of these stations as possible and sent off my reception reports. When I was through, I had sent out eight reports. Of those, six verified, giving me a total of seven Nigerians QSL'd. I then waited for another opening to complete the set, and it paid off, as the second week of December opened 90 m to the same area. Unfortunately, there are only two NBC stations on 90 m, but I got the elusive Kaduna, which is on 3396. Also noted, up on 6090, was the independent RTV Kaduna.

For the Senior Nigerian DXer Award you need one station in each of the 4 Nigerian regions plus the Federal District of Lagos. For the Master Nigerian DXer Award, you need verification of 9 or more transmitter sites in Nigeria.

DXER DE PACIFICA: This might seem like a tough one for the ECNA DXer, but it can be done. First off, you need 10 verified radio countries from the Pacific, as listed in the NASWA country list. There are, for openers, the big four, Australia, New Zealand, Hawaii (WVH), and now Guam. All these are easy to log and verify for an English report. Next come the two French speakers, Tahiti and New Caledonia, who QSL for a French report and a couple of IRCs. Then we have only four to go. The best bets to fill out the set are the stations in Papua/New Guinea. Port Moresby, 4890, is widely heard and friendly to QSL hunters. The rest are not too easy to hear, but are also good verifiers, with one exception - Radio Manus. It seems that they just don't like to answer the mail there. I have been trying to get a QSL for about eighteen months, but no luck so far.

There are, of course, others to try and some may be easier for you to hear, but these worked for me.

Radio Moscow

SOMETHING DIFFERENT FROM THE U.S.S.R.

by Kim Andrew Elliott, Minneapolis

On the evening of December 31, 1977 (U.S. time), Radio Moscow's North American service was on the air as usual. But Radio Moscow's programming that evening was an incredible departure from the normal fare offered by that station.

The 2230 transmission began, typically, with the news. However, the remainder of the half-hour segment was a special program entitled "New Year's in Moscow." The program dealt mostly with the holiday activities of college students in the Soviet capital. Most of the show was conducted in a manner more akin to Laugh-In than to the usual Radio Moscow format.

Early in the special, Moscow yoked it up with some jokes likely to be told by Soviet young people during the New Year's festivities. A mixture of music and laughter accompanied:

A: "I don't know what to get my husband for New Year's."

B: "Get him a book, that's always a good idea."

A: "But he already has a book!"

A: "I don't know what to get my wife for New Year's."

B: "Ask her what she wants."

A: "I don't have that kind of money."

A: "My wife has the worst memory!"

B: "Forgets everything?"

A: "No, remembers everything!"

Radio Moscow, safely assuming that its listeners' sides were not completely split by those gags, vollied some more people's humor across the Atlantic, this time a portrayal of what might happen during the oral exams of Soviet college students (of course, more music and laughter in the intervals):

A: "What's the difference between an active verb and a passive verb?"

B: "An active verb shows action, and a passive verb shows. . . passion?"

A: "What's a synonym?"

B: "It's a word you use in place of a word you can't spell."

A: "Do you think Shakespeare'd be so famous if he were alive today?"

B: "Of course, he'd be 413 years old!"

The December 31 installment of Moscow Mailbag was also atypical. Anabel Bukar began: "Here's Joe Adimov, but he's not going to answer all of your questions." Instead, Joe answered only two questions asking about the Radio Moscow North American Service announcers. He conducted informal interviews with his studio comrades and provided us with the following revelations (the spelling of names below is no doubt thoroughly botched):

Dmitri Linich is tall, dark, handsome with bushy sideburns that cover his cheeks. He is the North American Service's youngest announcer at age 26. He plays the guitar semi-professionally with a group called Zodiac, which performs mostly at colleges and universities. Linich describes the group's music as "chamber rock...a mixture of soft rock and traditional folk-style music like Bob Dylan's stuff, with a good bit of bluegrass mixed into it." A brief recording of his group's music followed.

Next, Joe Adimov spoke with Boris Neskevitch, whom he described as "tall, broad-shouldered, blushes easily, has a terrific sense of humor -- by which I mean he laughs at my jokes -- is a great fisherman, and tinkers with radios. In 1977, he moved into a new apartment and got a pay rise (sic). "I'm a confirmed bachelor" said Boris, "We have these in the Soviet Union, too, you know." Nevertheless, Boris is not indifferent to the "fairer sex." As a keen radio amateur, he pins his hopes on the on the "many beautiful female DX voices on the air in the amateur wavebands -- so the rest should be very simple." (What is the "rest" to which Boris refers?)

Joe then spoke to the female announcers. Lucy Brownunov was presented with a new granddaughter during the year. Joe opted not to ask her age. Lucy's plans were to spend New Year's Eve in the country with in-laws. Anabel Bukar, who reads the questions on Moscow Mailbag, was "indisposed" during part of 1977 (isn't that the same thing Breshnev had?) but is well now and wishes her friends across the ocean a happy new year.

Joe Adimov then describes himself: "I'm 57, stocky, I weigh 230 pounds, and whenever I go in front of a camera, they always use a wide-angle lens." Joe said he likes the suggestion of listener Brian Barry that the announcers identify themselves when reading the news -- said Joe, "This will go down in the history of Radio Moscow as the 'Barry Amendment'." (The amendment has yet to be enacted, because my listening on January 2 revealed no such giving of names at the beginning of the Moscow newscasts. Maybe the amendment has to be approved by various committees, councils, bureaus -- gosh, it could take months, years.)

Anabel Bukar herself had some questions for Joe Adimov. She asked what his most interesting experience of 1977 was. He replied that it was in England, while he was visiting Buckingham Palace. He was looking at two black lion statues and notices a hammer in the hand of one and a sickle in the hand of the other. "Hey, a hammer and sickle! What is this?" Chuckles from the others in the studio.

Then came the high point of the evening. In response to another question from Bukar, Joe said his favorite song was a catchy tune by a Latvian composer entitled "Follow Me." The Radio Moscow North American Service staff announcers gathered to sing an English translation of the song, with Eugena Stepanova of the letters department playing the piano (yes, it really happened). "We certainly are no singers," apologized Joe. "We're all a bunch of grunTERS." They grunted, not badly, the tune, with Mrs. Stepanova playing very well. (Poor reception did not allow me to comprehend the lyrics.)

After this gala performance, Mrs. Stepanova stepped on over to the microphone to wish all those crazies who insist on having "via Ashkabad," etc., written on their QSL cards (she didn't say that, but I'm sure she was thinking it) a happy new year, and to students, "good marks." Following this were some boring interviews with various Radio Moscow editors. Finally, Joe Adimov wished everyone the best for 1978 and closed by saying, "I'm going to give Anabel Bukar a big hug!" "Woooooo!" went Anabel.

Nice to know, after all these years, that the North American staff is human.

Pennants

MORE STATIONS GIVING PENNANTS

by Bill Sandborn, Savannah, TN

While reading the December issue of FRENDX, I noticed a list of stations who give out pennants. The list seemed rather incomplete, so I added all the others that I know of. The following information was taken from the QSL section of FRENDX and my own experience. I am sure the list is still not complete, but the majority of pennant givers are listed. When writing to these stations you should ask specifically for a pennant and you will have a better chance for receiving one.

COUNTRY	STATION	COUNTRY	STATION
Argentina	RAE	Germany (FR)	Deutsche Welle
Australia	Radio Australia	Guatemala	La Voz de Nahuala
Belgium	ORU	Hungary	Radio Budapest
Brazil	Radio Bandeirantes	Iran	Voice of Iran (NIRT)
Bulgaria	Radio Sofia	Israel	IBA
Chile	Radio Universidad de Concepción	Japan	Radio Japan
China	Radio Peking	Korea (north)	Radio Pyongyang
Colombia	Radio Colosal	Korea (south)	Radio Korea
	Radio Guatapurí	Mexico	Radio Mexico
	Ondal del Ortegaza	Monaco	Trans World Radio
Costa Rica	Radio Casino	Mongolia	Radio Ulan Bator
Cuba	RHC	New Zealand	Radio New Zealand
Dom Republic	La Voz de las Fuerzas Armadas	Norway	Radio Norway (small flag)
	Radio Clarin (to be printed in early 1978)	Papua/NG	NEC
Ecuador	HCJB	Portugal	Adventist World Radio
	Radio Splendit	Poland	Polish Radio (after 5 reports)
	Radio Zaracay	Romania	Radio Bucharest
	Radio Centinela del Sur	South Africa	RSA & Springbok Radio
	Emisoras Gran Colombia	Spain	RNE
England	BBC (only if you are a WRC member and win pennant competition)	Sweden	Radio Sweden
Finland	Radio Finland	Taiwan	Voice of Free China
France	Radio France International	USA	KGEI
Germany(DR)	Radio Berlin International	USSR	Radio Moscow
		Venezuela	La Voz de El Tigre, Radio Anogostura, Ecos del Torbes
		Vietnam	Voice of Vietnam

Grounds

GROUND SYSTEMS

by Mike Tiers, West Vancouver BC

A good ground system is very essential to good DX results. The ground improves antenna efficiency, receiver stability, and also helps to cut out man made noise such as power lines, passing cars, and household appliances. The basic 6 foot copper rod is ok, but it can be improved upon. One way is to dig a hole about 2 feet across and 3 or 4 feet deep around the ground rod. Fill the hole with rock salt and cover with dirt. Then douse the whole thing with water. The salt water then seeps through the dirt and improves conductivity. Just don't expect anything to grow in the vicinity of the rod.

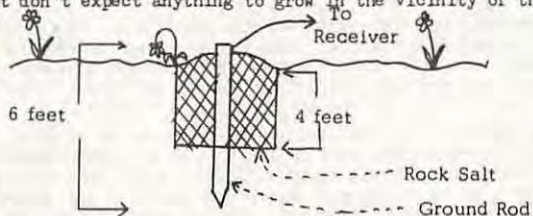

There is another variation of this design. Instead of packing rock salt in the hole, you may use charcoal. The charcoal absorbs water and improves conductivity. This method is used by some professional firms.

A ground system used by some hams is to have a center ground rod and from this extend 8 to 12 radials, 6 feet long, which are connected to smaller ground rods and driven into the ground.

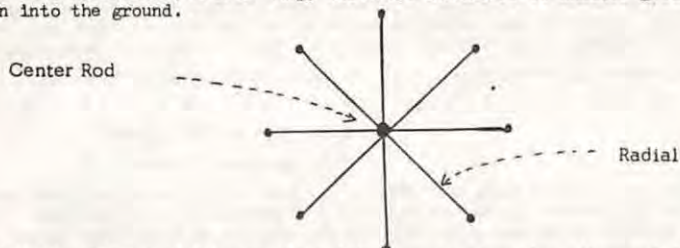

A ground system used by some electricians on construction sites and for lightning arrester systems is to bury a thick copper braid in a trench. You can bury this in the garden or elsewhere and attach a lead wire. It should be about 2 feet deep, at least, and it should be kept moist for best results. Therefore, if it is in the garden or under the lawn where you normally water anyway, you will have an advantage.

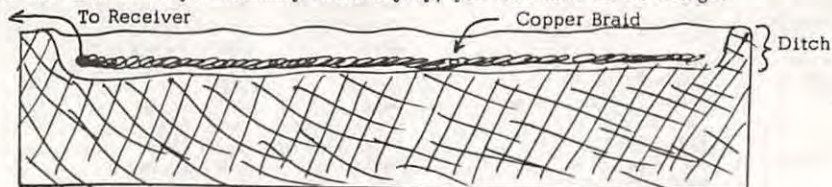

Large pieces of metal may be used for grounds. Things like engine blocks, metal bed frames, and other such items may be buried in the ground. Chemicals and acids may be experimented with to improve ground rod conductivity. Just don't pollute your environment too much.

SUGGESTION TO CONTRIBUTORS You should prepare your own camera ready copy of drawings and illustrations. Do them in black ink on white paper. Prepare them for 50% reduction. Maximum original size is 8 x 11 inches. Careful hand lettering is fine. I will cut the illustrations out and paste them in the appropriate place in the article. Otherwise you will have to put up with my spastic art work.

QRP Award

THE 50 KW QRP AWARD

by Gerry Bishop, Christiana, PA

About a year ago I wrote an article on how to acquire this award, using mostly English as the language to listen for and use in the reception report. Several factors have made that article outdated, so I now present some tips on how to earn this award now, in early 1978.

Basically, the award is an accumulation of power totals, comprising one station from each of the six continents, for a total power of no more than 50 kW.

Perhaps the easiest continent to hear and verify on a low power is Oceania. The best bet, for the lowest power and a full data QSL, within a reasonable time is Radio New Zealand. RNZ is easily heard over all of North America, despite their output of only 7.5 kW. Check Log Report, Listeners Notebook, and the WRTH for schedules, and frequencies.

Asia is covered with low-powered transmitters. For those on the west coast, Indonesia may be the best place to snag a 5 or 10 kW station, though Brunei, Malaysia, and other areas all have stations with 10 or less kW output. For those on the east coast, an Indonesian is almost the only way to get 10 kW without too much difficulty. For those who don't like to get up early, there are the Turkish stations operating around 49 and 41 metres. The Meteorological station on 6900 is sometimes heard around their sign-on, and they will verify easily, provided that return postage is sent.

Africa is next, and there are two countries that can be heard in English, will QSL, and operate on a low enough power for our use. Ghana is one, and their 10 kW transmitter on 4915 is often heard all over North America. You might also try Nigeria. The stations at Lagos are all too powerful, but the regionals all employ 10 kW output. One of the more often heard is Enugu on 6025. A QSL for this one also counts as another NASWA country, due to its location in what was once Biafra.

So far we have 27.5 kW, and three more continents to go. Let's look at South America next. There are many 1 kW broadcasters in SA, and you should have no trouble hearing at least one or two. One of the easier ones to verify is Radio Occidente on 3225 in the 90 mb. If you report in Spanish, you will very likely get a QSL in two months. (What? You say you don't know Spanish? Write to NASWA HQ, send a business SASE and ask for a Spanish report form, or all three forms, for that matter. A good report form is essential unless you are fluent in the language.)

Moving on to North America, it is possible to get away with 1 kW here, also. If you live where the reception of those low powered Canadians is possible, try them! The most powerful one is CFRX in Toronto with 1 kW. You might get one even lower. Especially for you on ECNA, try for CKZN, 6160, in St. Johns, Newfoundland. This would count as another NASWA country, and also has a power of only 300 watts.

The total is now at a maximum of 29.5 kW, leaving just over 20 kW left for Europe. Unlike other continents, however, there are relatively few low power broadcasters. In Germany, however, there are two stations that use 20 kW transmitters. Of these, Süddeutscher Ruffunk and Südwestfunk, the latter is easier to hear. 7265 kHz is the place to look, and if propagation is good and the AROs are off the frequency, they will be in after 2000 GMT. Or try around 0400. Send an IRC with your report.

Tape Your DX

THE TAPE RECORDER AS A TOOL FOR THE DXER

by Garry Sapoznikow, Winnipeg, Manitoba

Many a DXer has probably waited patiently for an ID from a weak station on a crowded frequency, only to find that because of a momentary distraction, or lack of comprehension, the ID is missed or cannot be understood. Another frustrating wait is in store, which severely limits the time available for logging rare DX on other frequencies.

But this need not happen too often, if you are fortunate enough to have a tape recorder patched into your receiver. The tape recorder will give you another chance to hear again the ID you just missed. It is often possible to replay your tape of that weak, noise ridden signal a few times, until the faint ID is suddenly understood.

If your recorder is equipped with a digital counter, it is possible to locate the exact part of the tape you might want to replay. A whole night's tuning can be recorded with the only limiting factor being the amount of tape you have available. A notebook is necessary for jotting down certain details such as the tape counter reading to permit quick reference at a later time. In addition, the frequency and time of the mystery ID, along with any other useful items, will provide excellent clues as to the station's identity. Adequate care in this record keeping will save yourself endless hours of replaying tapes in search of a few critical segments with station IDs on them.

However, if your recorder does not have a digital tape counter or you simply do not want to tie up large amounts of tapes, an effort can be made to record only the critical portions of the station's transmission. These critical portions would encompass items such as IDs, jingles, commercials, time checks, and other clues which would lead to either a confirmed or tentative logging. As experience is gained by the DXer, certain similarities are noticed in station formats.

Eventually, a sense of timing is acquired as to when a station can reasonably be expected to identify itself. Just about every international SW broadcaster identifies itself during sign on. Most stations will do it on the hour or every half hour. Sometimes IDs will be heard at the beginning or end of commentaries & news bulletins, between musical selections, or during a series of commercials. Last but not least, there is the sign off announcement which usually is a fine source for IDs.

As soon as you sense an identification is about to come in, it is very important to activate your recorder immediately. An opportunity to replay the ID several times, usually comes right after it has been recorded. While the tape is being replayed, the station would meanwhile be in the midst of a program or selection of music. If the tape is not suitable quality, it is possible to go back to the radio and make another attempt to get a better recording. The music or the program would likely be close to ending and a station ID would soon be coming up.

Depending on personal interests, there are other ways in which a tape recorder can add to the enjoyment of the DX-SWL hobby. Many interesting programs, historic news bulletins, documentaries, and unusual music can be preserved for future use at the listeners convenience. As a tool for identifying rare DX, it is almost unsurpassed. In any event, a tape recorder is a worthwhile investment for any DXer to consider when setting up a monitoring post.

DX Aids

SIX AIDS TO HELP YOU BETTER ID THE SLIPPERY ONES

by Edward Shaw, Lexington, KY

Is there just chance involved with logging those weak and faraway catches? Or, is there some way to increase the likelihood of success? The answer is YES, you can increase your chances by understanding more about how signals come to you.

THE DESIRABLE WEAKIES always seem to lie in some part of the world where no DXer can rout them out. Quite a few of them are in the tropical zones around the globe. Most of these stations are regional in nature, meaning that power is likely to be low . . . under 5 kW and perhaps only a few hundred watts. Antenna designs used by those stations are likely to be simple compared to the sophisticated arrays used by the international broadcasters. Thus, the power you might receive from an inefficient antenna system could be drowned in atmospheric noise.

ANTENNA NOISE includes a number of things, but most of us are willing to acknowledge the biggest headache is static from atmospheric phenomena. In reality, such noise is not really phenomenal. It is all caused by thunderstorms throughout the surface of our globe. The noisier conditions seem, the more thunderstorms likely to be between you and the transmitter locals. In addition, there are other noises from cosmic sources which add to the bombardment of our ionosphere. Local interference from powerlines, TV radiations, diathermy sources, etc., also contribute to our headaches.

SKIP DISTANCES are important to understand. Depending on the frequency of the station heard, the skip distances of their signal may or may not hit near your listening location. If most of their signal is being reflected off the ionosphere over your head, you aren't going to hear much of them. A signal transmitted from a radio station travels out in a straight line. If it hits the ionosphere directly straight up, it will punch through and be lost in space. If the signal is reflected too flatly off the underside of the ionosphere, the signal will pass on over the horizon in a straight line, again missing the target. There is an "ideal" distance at which point the signal can be reflected properly. This distance varies according to frequency. Some frequencies require only one reflection off the ionosphere to hit down on your radio-listening area. Others may require several up and down reflections off ionosphere and ground to reach your area. But, remember . . . your area may often be "down" when the signal is "up". Radio Nederland's propagation course gives excellent information to those interested in determining what those reflection distances may be.

DARKNESS PATTERNS figure critically into the scheme of logging distant stations. Experience soon illustrates to the serious hobbyist that certain bands are heard only during certain times of day. Though it is only a general rule of thumb, one might consider that frequencies of 10 MHz and below are available at night and periods of dusk and dawn. Conversely, those frequencies of 10 MHz and higher are available during daylight hours.

There are always exceptions to the rule. Obviously, everyone has heard such powerful broadcasts as Tahiti on 19 metres throughout the night, but consider that their signal originated in a daylight zone. Low frequencies especially can be narrowed down as to origination point with some degree of accuracy just by knowing a bit about propagation and darkness paths. The most striking example is the 60 metre band. In late daylight afternoon, stations heard on 60 metres are likely to be western Soviets, followed shortly by central and western Africans which begin to shut down by 2300 GMT. Appearing among these by 2200 GMT will be the Spanish-speaking Latins, most of which will be around until 0300, 0400, or 0500 sign-off hours. Some will stay all night. For that matter, some Africans stay all night, like SABC. After the Latins begin to subside, the Pacific Islands begin to fade in around 0800 GMT. Papua New Guinea stations and east Indonesia will appear and then fade away around 1000 GMT only to reappear again about 1100 with sometimes apparent increased strength. I call this the "Henderson Phenomenon" for lack of a better official name in recognition of Dan Henderson who was first (to my knowledge) to observe and report this predictable event. The phenomenon is most apparent on the west coast, easterners having too short of a "window" period to notice it.

KNOW YOUR RECEIVER. The best service one can do for himself is to know the capabilities and limitations of his receiver. Can you distinguish between images, spurs, and true fundamentals? Can you manipulate your receiver to eliminate or attenuate false signals? Can you determine accurate frequency to within one kHz? Professional stations of the major industrial nations will likely be "right-on" frequency - or the frequencies announced. Our Latin neighbors aren't nearly so finicky about this.

ARM YOURSELF WITH CURRENT INFORMATION. Refer to several club bulletins or subscribe to a few quality DX-information sources if you can. Admittedly, it may take a bit of money to keep in with information, but where else can you get it? If you are interested in Asian stations, then one of the excellent Japanese clubs would be a great help: For Europe, perhaps the Danish SWL club would be of interest: Australia is home for several very good clubs concentrating on the Pacific and Indonesia.

LEARN TO IDENTIFY THE LANGUAGES. Nobody says you have to learn how to converse in Urdu, but one can certainly learn to identify the sound and qualities of dozens of languages after a year or two of experience. Tuning regularly to the VoA or BEC foreign services helps tremendously. French and Spanish, German, and Arabic are absolutely essential from the first day. Anybody who cannot identify those separately, immediately without hesitance should surely study very much harder. Soon, Russian, Italian, Portuguese, Dutch, Swedish, and Japanese will come easily. Chinese is easy, too. Before long, you will be able to recognize Urdu from Tahitian.

- - - - -

The foregoing information is nothing new to hordes of DXers who have come and gone before you, but they are steps logically taken to aid in the positive identification of stations which have escaped you before. Who knows? You may have been hearing them all along, but not realizing it. 73, Ed Shaw.

NOTICE OF DISCLAIMER! We often publish electronic circuits or plans for receiver modification in Shortwave Center. The responsibility for the correctness of the circuit or of the modifications lies with the author and not with NASWA or your Shortwave Center Editor. If the circuit fails to do what is said, contact the author. We do not recommend that anyone modify their receivers unless they know what they are doing. It might be better to take the receiver to a technician for the modification. Manufacturers will void any guarantee if a receiver is modified, generally. Some modifications will do what is stated but may also cause other problems to crop up in the receiver. So beware and use caution before you take the soldering iron to that new \$300 receiver.

SELECTIVITY MODIFICATION OF THE DRAKE SSR-1

by Bill McMullen, 7-G, 555 E. William,
Ann Arbor, MI 48108

SSR-1

Drake Co. says that the AM selectivity of this unit is 5.5 kHz plus or minus 2% for 6 dB down. I soon became very annoyed by this but was pleased to see that by the simplest modification imaginable the SSB 3 kHz filter could be used on AM mode without activating the BFO. The 455 kHz filters have connected across them a 30 pF capacitor for SSB operation, and when the mode switch is set for AM an additional 60 pF is added in parallel. Therefore it is only necessary to permanently remove the two 60 pF capacitors from the system. Actually the best procedure is to simply unsolder from the circuit board the blue and blue-white wires leading to C-96. I left the short wires attached to the switch and taped the ends just in case I ever wish to restore the unit to its

original condition. The 6 dB bandwidth with this modification is between 3 and 4 kHz and I am able to locate stations adjacent to powerful locals on both shortwave and mediumwave.

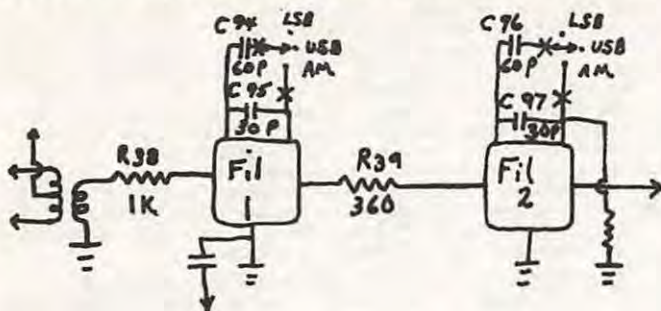

FRG-7

ZERO-BEATING THE FRG-7

by Mark Westling, 2710 Pinewood
Austin, TX 78757

A very simple modification allows the user of the FRG-7 to zero-beat a signal. In the FRG-7, the "USB-CW" and "LSB" modes add a beat frequency oscillator signal slightly below or above the carrier in frequency in the third IF stage (IF=455 kHz). To zero-beat the carrier on its correct frequency, the BFO must be tuned exactly to 455 kHz. This isn't hard if you have access to a frequency counter. The maintenance and alignment section of the instruction manual gives information on adjusting the BFO. A tuneable coil, T₄₀₆, is used to set the LSB beat frequency to 457 kHz, and a trimmer capacitor, TC₄₀₄, is used to set the USB-CW beat frequency to 453 kHz. It may be possible to tune one of these to 455 kHz, but I took a fancier approach. I inserted a capacitor in series with TC₄₀₄ which may be bypassed with a switch mounted on the back of the receiver. This extra capacitor will raise the beat frequency on the USB-CW setting to 455 kHz, while the switch will allow you to change back to 453 kHz if you desire.

I tried using several variable capacitors that I had handy, but the minimum capacitance on each of them was too large. My solution was to make my own capacitor. I took two pieces of plastic insulated copper wire and twisted them together until I had a piece a few inches long. I then started snipping off the end until the frequency counter read 455 kHz.

I find this very useful for tuning.

WE NEED MORE SHORT AND LONG ARTICLES FOR SHORTWAVE CENTER. BE AN AUTHOR, SEND US YOUR CONTRIBUTION TODAY. $\frac{1}{2}$ to 3 FRENDX PAGE LENGTHS PREFERRED, BUT SHORT NOTES APPRECIATED AND LONGER CONTRIBUTIONS CONSIDERED FOR SERIAL PUBLICATION OR NASWA SPECIAL PUBLICATIONS. SHARE YOUR EXPERTISE WITH OUR READERS TODAY. SHORTWAVE CENTER IS WHAT YOU MAKE IT. THESE PAGES WILL BE INTERESTING AND VALUABLE TO YOU ONLY IF YOU AND OTHERS SEND APPROPRIATE CONTRIBUTIONS. ARTICLES ON ANY SUBJECT RELATING TO SHORTWAVE BROADCAST RADIO CONSIDERED.

SPECIAL PUBLICATIONS AVAILABLE: The following NASWA Special Publications are still available. SP 1; Keep it Quiet by Morgan Monroe, 10 pages on limiting receiver noise \$1.00. SP 2; Precision Frequency Measurement by Charles Taylor, 12 pages on the heterodyne method of accurate frequency determination, \$1.00. SP 3; Introduction to Shortwave Propagation by John Tuchscherer, 6 pages on basics of ionospheric radio propagation, 75¢. SP 4; Complete Results of the 1976 Survey of the North American Short Wave Association by K. A. Elliott, \$1.00. SPECIAL OFFER made for the first time. ALL FOUR PUBLICATIONS SENT AT ONE TIME FOR ONLY \$3.00. Always sent First Class Mail (for what that is worth). Send all orders with payment made to Jerry A. Lineback, P. O. Box 325, St. Joseph, IL 61873. Do not send orders for Special Publications to Headquarters as that will result in a delay while Mac bundles them up and sends them on to me.

MAILBAG Paul C. Gunn, 1396 South Fourth St., Aurora, IL 60538 requests NASWA members in the Chicago area who get the Chicago Tribune or who are interested in publicity for the hobby, write to the Tribune requesting that the International Radio Broadcast Scene be given space in the paper similar to coverage of other aspects of the

radio spectrum. They even have a Saturday section 'what happened in the soaps'. His own efforts haven't produced results and his last effort was answered by "thanks for the comments on coverage, or rather lack of it on "Ham" radio". Paul also suggests that others suggest coverage of the International Broadcast Scene to their local papers.

Alan Plotnick, 77 Woodlawn St., Hamden, CT 06517, writes to inquire about the availability of the RCI cassettes that enable DXers to learn how to learn how to identify stations, anthems, and languages. With the continued growth of NASWA membership, tapes of a similar nature should be available somewhere in updated versions.

Antenna

UNUSUAL BROADBAND DIPOLE ANTENNA

by Frank Hermann, Kitchener, Ontario

Shown below are plans for a rather unusual broadband dipole antenna that was used some years ago by a university in radar studies. This should be mounted at least 15 feet above ground. The length of the center section is determined by dividing 325 by the desired frequency in MHz (example: for 10 MHz the center section would total 32.5 feet) and the total length is 460 divided by frequency in MHz. Construction is recommended of 7 x 22 pure copper wire or copperweld. The antenna has small loops at each end which are carefully hooked and soldered. The section for the center insulator where the antenna wire ends and downleads meet is also soldered. Two insulators are recommended at each end. The spacers in the loop section should be of plastic, pexiglass is good. The spreaders should be equal in number and spacing at both ends of the antenna.

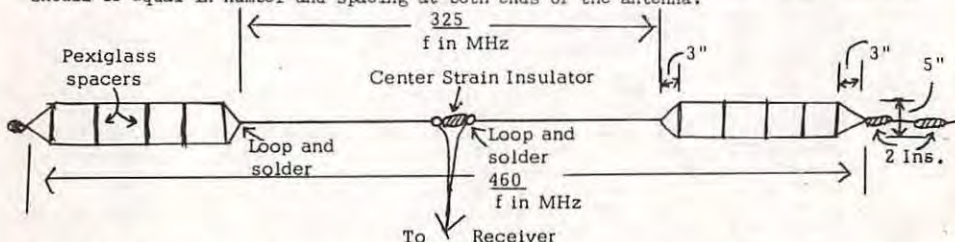

Propagation Conditions

by Jerry A. Lineback

Solar activity is picking up. The solar flux reached its highest point since October 1975

on 02 January 1978. Below are two graphs showing the difference in solar flux values between similar periods between September and January 1976-77 and 1977-78.

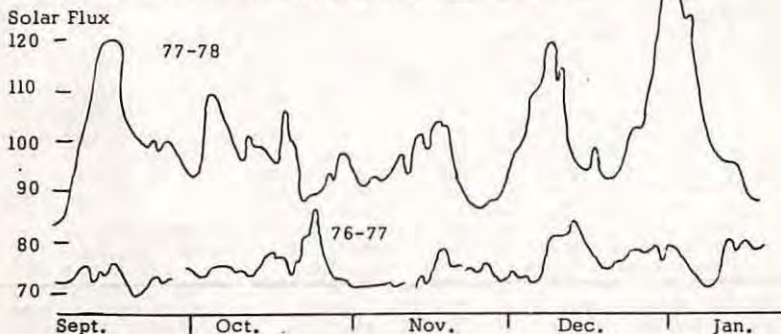

This diagram illustrates the general increase in the level of solar activity in the past year and the fact that monthly peaks are becoming more pronounced.

The forecast is that activity should be low until 22 January when the level should increase. The next flux peak would be near 29 January. Geomagnetic activity should be quiet until the 30 January to 06 February period. Flare induced disturbances are possible after 27 January. 73 till next month. Keep the material coming. -Jerry A. Lineback

- 6015 DODECANESE IS. VOA-Rhodes: 2130-2140 EG nx and rpt, poor(Sarrazin 12/27).
- 6015 AUSTRIA GRP: 0432 EG nx, and topics(Altman). 0530 GM amnts, Class mx(Brookwell).
- 6020 PERU R. Victoria: 1040 SP ads, chorus and accordion mx, pop mx(Zilmer).
- 6020 HOLLAND RN: 2145-2220 EG //6085, 9715, DX Jukebox(Zilmer, Fraser, Burke).
- 6020 USSR (European site): RS 0230 with IS and ID(Cliff 1/3) I believe this is Mayak -sw
- 6025 UZBEK SSR R. Tashkent: *1200 ID, EG nx w/quotes from Pravda(Cohen-NJ).
- 6025? NIGERIA NBC-Enugu: 1005-1035 Non-stop instrumental mx, fading 1025(Earhart).
- 6025 PORTUGAL RP: 0150 PT songs(Leffler). 0300-0330 EG nx about Portugal, 1977 highlights in Portugal(Alexander, Bohlke, Pearson). 0525 EG, mx(Swanson).
- 6030 ITALY RAI: 0100-0120 EG nx read by W(Berowski) -or is it Berezowski?
- 6030 GREAT BRITAIN BBC: *2210 IS, ID into PT w/nx(Zilmer, Brown). /PR
- 6035 AUSTRALIA RA: A surprise at 2200 via LP, EG nx. I think this is Carnarvon(Hauser-/
- 6035 LIBERIA VOA-Monrovia: 0313-0428 EG African Safari, Breakfast Show(Bryan).
- 6035? BRASIL R. Globo: 0125-0135 Rapid cmtry in PT, QRM de DW(Brown).
- 6035 USSR (Asiatic SSR) Nikolayevsk: 1905 in RS //6080, 7120, 7150, ID 1906(Hywarren).
- 6040 EAST GERMANY RRI: SP talk on Communism //6070 at 0153(Leffler 1/3).
- 6045 SWITZERLAND SBC: 0430-0450 EG to Nam, Dateline, Swiss mx, ID(Hoffmann, Hutchins).
- 6050 GREAT BRITAIN BBC: EG 0530 "Face of England"(Zilmer).
- 6055 CZECHOSLOVAKIA R. Prague: 0850 EG, "Inter Pgm", Strong(MacKay 1/1)
- 6055 JAPAN NSB: 0730 in JP, ID by M, beautiful mx, tk by M in JP(Hywarren 11/19)
- 6055 USSR (European site): RS 1850-1905, ID 1900 "Govorit Moscvn", then nx(Hermann).
- 6065 SPAIN RIVE: 0100-0157 EG, Classical mx, M&W w/nx, tk on Spains political condtions (Reno, Plotnick, Leffler). 0230 EG nx(Prath). 0300-0335 EG nx(Alexander, Welch).
- 6065 CANADA CBC(Northern Service): 1340-1345 EG and Inuktituk, cmtry(Desrosiers, Prath).
- 6065 COLOMBIA R. Super: 0650 SP, LA mx and TC, ID's(Gallagher).
- 6065 SWEDEN RS: 2110 EG holiday mx for Eur, ME, Afr.(Cohen 12/26).
- 6070 CANADA CFRX: 1935-1436 ID by M, EG nx, wx, ads, pop mx, TC's(5 reporters).
- 6070? BULGARIA R. Sofia: 2358-0100 EG, IS, ID, cmtry, EG nx replaces 9705, Bulgarian Folk mx o/CFRX(Berezowski, Welch, Zilmer, Swanson).
- 6075 WEST GERMANY DW: 2355-0007 SP nx, mx ID(Bogel). 0128-0145 EG nx, IS, ID(Welch).
- 6075 ECUADOR HCJB: GM 0930 to Sam, ID(Tannenwald).
- 6080 BELGIUM BRT: I can imagine the engineer at Wavre sound asleep. At 0014 12/11(Dec11) tuned to BRT, finding FR instead of DT; DT amnt then into EG pgm. 0017 tape went into fast-forward on air, followed by lengthy silence. More dead air as the xmtr stayed on past 0100. What an amateurish operation this station is!(Hauser). ID, nx, "Today in Belgium", "Mailbag", pop mx(Sandborn, Bohlke, Welch, Earhart, Pick)
- 6080 CANADA CKFX Vancouver: 0050 CKXK relay, EG(Berezowski 12/18).
- 6081 CANADA BBC via Sackville quite out of whack again on 12/17, when checked at 1310 Found very distorted, nothing on sked 5990, leaving it clear for NHK as it should be! Whitaker-MI called me on 12/15 saying he had BBC on 6090 at same time(Hauser-TN)wow!
- 6085 HOLLAND RN: EG DX Jukebox 2145, Dutch lang lesson(Zilmer 11/24)
- 6090 NIGERIA RTV Kaduna: 2035 EG nx to 2045, ID, Afro mx(Bishop 12/12).
- 6090 LUXEMBOURG RL: 0015-0058 M in EG w/nx, wx, ads, rock mx, Pair(5 reporters).
- 6095 POLAND Polish Radio: 0200-0220 Carters speech, EG nx(Petravick, Leffler, Bishop).
- 6095 BRASIL R. Tupi de Sao Paulo: 0225 in PT w/futbal, ID 0230, ads. Pair(UMDX 11/16)
- 6100 MAITCA DW: *0129-0150* EG nx and cmtry, tk about terrorists (6 reporters)
- 6100 MOROCCO RTVM: 2107 AR mx and men shouting(Valko 12/22)
- 6105 HUNGARY R. Budapest: EG DX pgm, ID's, tk by M&W 0314(Jones). 2130 HQ? (Valko).
- 6110 GREAT BRITAIN BBC: 0209-0220 SP nx read by M (Valko).
- 6115 MEXICO R. Univ. de Sonora: Non-stop classical mx 2210-2308 (Bogel).
- 6115 COLOMBIA LWD Llanos: 0222 SP, loud ID's, jingle-bells(Valko). 1141-1200 M in SP w/amnts, pop mx, local amnts, bells(Strawman, Prath, Taylor).
- 6120 SPAIN RIVE: 0206-0405 SP nx, tk & guitar instrumental mx(Hascall, Leffler).
- 6120? VENEZUELA R. Angostura: Close enough to be regular daytime fare in PR. ID as "en Angostura, la emisora del pueblo". (Hauser-PR) Hauser lists freq as 6119, sorry.
- 6120 PHILIPPINES FEBC: DX Mailbag pgm, Reception reports, Good w/QRM(Bogel).
- 6120 CANADA Sackville BBC: 0050 EG, //6195, 6005 et al (Cliff 1/3).
- 6125 USSR - European site: 2250-0209 EG nx, political prisoners in Chile(Leffler, Filka).
- 6130 VENEZUELA R. Valles del Tuy: noted 1304 w/ID (Hauser-PR).
- 6130 CANADA CHXK Halifax: EG dj, wx, ski conditions, Ad. Poor(Osterman 12/21).
- 6130 ECUADOR HCJB: 0930 EG, ID, IX Partyline consisting of 21 minutes of DX info, 3 minutes introduction, 4 minutes tips for real living & 2 minutes closing(Kukan-NJ).
- 6135 BRASIL RTV Gaucha: PT Accordion mx 0815M ID's, TC's, ads (Bishop).
- 6135 SWITZERLAND SBC: 0143-0211 EG tk, Dateline, cmtry, tk on Carters overseas plans (Gallagher, Leffler, Welch). 0344 FR w/orchestral mx, ID by W, then II(Desrosiers).
- 6140 AUSTRALIA VLN6-Perth: EG nx, sports & wx 1405. Good level (Florian 12/29).
- 6145 ALGERIA RTV Algeria: AR songs, AR nx 0800, freq. amnt @ 0803. //9685 (MacKay).
- 6145 WEST GERMANY DW: 0130-0145 GM, "Dixieland jazz"mx sung in GM, GM tk by M&W, pop mx(MoCante). 0300-0355 GM nx, IS, cmtry, DX pgm on Sunspot #'s (Dunn, MoCante).
- 6150 COLOMBIA LWD Buila: 0244-0349 lively LA mx, TC's, ID's(Valko, Brouillette) 1240 SP mx pgm w/M announcer (Prath).

PORTUGAL EG from Adventist World Radio via R. Trans Europe, Sines, on 9670 Sun 0900-1000; Tue 2115-2130 (ARDXC via RA DX 8/1) Am hearing "The Voice of Faith, R. Vox Fidei" on 9670 Sat only at 0630-0730. Not listed in WRTVH 77 (Larry McKinney, PA) Tnx for tape, Larry (gh)

POLAND R. Warsaw: 0200-0400 mixed with Polish, to NAM 15120/11815/9525/7270/6135/6095. 0630-0700 Eu 9675/7270/6135. 1200-1230 Eu 7285/6095. 1230-1300 Af 15120/11840/9675/9525/7125. 1600-1630 Eu 9540/6135. 1630-1725 Af 9675/7125. 1630-1700 Af 11840/9525. 1830-1900 Eu 7285/6095. 2000-2030 Af 9675/9525/7145/7125. 2030-2100 Eur 7285/6095. 2230-2300 Eu 7270/7125/5995 (BBCMS 12/77)

NIGERIA The 0555-0835 xmsn of VON was broadcast solely on 7275, for WAF. //15120 returned to the air 5/1 after a long absence, for Eur (BBCMS 5/1 & 12/1)

NEPAL R. Nepal ES anc'd that EG is at 1440-1520 on 5005/3425 with nx 1450 (BBCMS 5/1)

MONGOLIA Ulan Bator's ES in EG to SEAs & FE obs 1220-1250 on 12070/6385; 1715-1745 on 9575/7262, both not on Sun (BBCMS 22/12) The ES is not on either 17785 or 15445 (Willis, Vic.)

LEBANON EG at 0230 is on 9680 (Arthur Cushen, RN 5/1) Heard on 9680 at 0230 with ID as "This is Beirut; this is the Overseas Service of Radio Lebanon (Gary Fowler, Ont., ODXA, via Mike Bolitho) EG hrd beginning at 0236 until around 0300, on 11755, anc'd for NAM & all EG-speaking listeners overseas (Bob Padula, RA DX 1/1)

IRAQ R. Baghdad now has EG for the Ams at 0300-0400 on 11905 (BBC MS 1/78) Barely audible 22/1 at 0300, het, fadeout. But should get better and better till fall; rerun of 1930 (gh)

INDONESIA VOI ES now on 7110 ex-9585 //11790, 0100-0200, 0800-0900, 1400-1500 to SEAs & Pac (BBCMS 5/1)

INDIA AIR ES: 1000-1100 GOS to NEAs & AuAs 17387/15250/15205/15190/11775/11725. 1330-1500 GOS to SEAs 15335/11810. 1745-1945 GOS to EAF, UK, WEU 15125/11620/9730/9525/7225. 1945-2045 GOS to N&Waf, UK, WEU 11880/11620/9912/9755/9525/7225. 2045-2230 GOS to UK, WEU, AuAs 11740/11620/9912/9525/7225/7145. 2245-0115 GOS to NE&E&SE As 11850/11815/11770/9630/9535/7215/6085/3905. (BBCMS 12/77)

GUAM KTWK Agana on new 11730 *1100 EG (Graham Daff, Melbourne, RA DX 25/12) Has been announcing it would change from 31m=9640 kHz to a new 19m channel, at 1100-1500, affecting EG & Mandarin pgms, awaiting approval of FCC (RA DX 25/12) Obs on new 15195 //11730, 1100 EG; very poor, co-channel QRM with R. Japan (RA DX 8/1)

ETHIOPIA VORE ES hrd at 1700 around 6205 kHz (S. Abayashiri (sp?), Sri Lanka, SCDX 1/10)

EGYPT (Cf Dec LN-1) R. Cairo's new 6230 at 0200-0330 is ex-7120; //9475 (Charley Hoffman, PA, 3/1) Is //7260 (Richard Stoller, NY) Eu svc resked to 2230-2345 on 9805 (SCDX 27/12) ES re-organized during Dec. EG to NAM 0200-0330 on 9475/6230; to SAS 1215-1330 on 17920 (BBCMS 12/1) We can't hear anything on 9805 at 2230 (George Wood, SCDX)

DOMINICAN REPUBLIC R. Clarín gave good reception at 2130-2200 on 11700 with background QRM from Libya. Also heard with EG segment at 0630-0700. It announces as coming from "the Number One Disc Jockey of the D.R. in the Happy City". (Bob Padula, RA DX 1/1) The only R. Clarín EG programs are at 2130-2200 and 2300-2400 (Rudy Espinal, R. Clarín, 17/1) And some of these were re-run several times while Rudy was away in Miami serving as official interpreter for Pres. Balaguer (gh)

COLOMBIA R. Bucaramanga, 4845, hrd at 0323 6/1, SP & EG anmts; 0404* (Jack Jones, MS)

BULGARIA (Cf Nov LN-1) From 2/1 the 2130 R. Sofia xmsn is on 9765/9530. From 6/3 the 1930 -2000 freqs will be 9765/9530; to NAM at 0000 on 9707 (sic; 9700?) from Mar, ex-6070; and at 0430-0500 9765 replaces 7115 from 31/1 (Deith Devereux, WDXC Contact) To Af, 1830-1900 on 17845/9700; 2030-2130 on 11765/11735/9700 (BBC MS 1/78)

BELGIUM BRT at 1715-1800 is not on 9755 but 9760 with QRM from VOA, Moscow (David Crystal, Israel, SCDX 10/1 via gh)

AUSTRALIA R. Australia freq sked; D77

21570 08-10	17715 04-05	15240 22½-07½	11900 15-17½	11740 07-09	9580 11-13	
21455 22½-03	06-06½	15205 04-05	14-17½	11725 19-21½	9570 07-09	
17870 00-08½	15410 01½-04	06-06½	11840 20½-22	11705 09-16	9505 18-20½	
17795 01-05	15370 08-15	15160 21-24	11820 21-24	9670 11½-13	6035 21-22½	
	06-07½	15355 00-05½	01-05	11810 19-22	14-17½	6005 15½-17½
17745 04-10	15320 22-24	06-07	11790 22-23	9600 18-22	5995 10-20	
17745 02-10	01-05	15140 22-06	10-15	9580 18-22	(RA via BBCMS 11/77)	

ALGERIA (Cf Jan LN-1) For R. Algiers ES in EG 1900-2000, 7050 is used but announced as 7045 (Tony Legendre, France and/or Daniel Felhendler, France and/or BBCMS via SCDX 13/12)

LAST MINUTE ITEMS

NORTH SOLOMONS R. NS, 3322, 14/1 1245 Pidgin phone-in show! **GUYANA** (cf LN 7-8) GBS 0900 17/1 on 3290 **MOZAMBIQUE** (tent.) R. Moz. 2201-2213* 18/1 on 3210a AK/EG, 4-note chime IS (Syd Osterman, Ont.) **NIGERIA** (tent.) On 4720 maybe RTV Kaduna per DSWCI TBS seems Hausa E/in 2100, E/out 2145. On 5870 some Asian, 13/1 1200, 8-note IS. **USA** On 4680, WQXR NY 3 x 1560 around 1400-1500 (Richard Stoller, NY)

OTHER SCHEDULES

VIETNAM New stn R. Tranh Hoa obs on 4882 *1030-1100*, first hrd 16/12. Stn on 4599 at *1130-1200* now IDed as

"Office of People of Son Be Province". R. Son La using 4770, old R. Tay Bac outlet //6330 *1200-1400*. R. Cao Lang now on 6225, ex-6210 since early Dec, China QRM (Isao Ugusa, FE DX Review 29/12)

U S S R Spl pgm for seamen "Kamchatka rybatskaya" (Fishers' Kamchatka) is now on 5900/5940/1715/9580 from Petropavlovsk at 1800-1900 Tue/Thu/Sat; 5940 best (Takahiro Saito, FEDXR)
R. Yerevan Sun to Eur *0800-0900* in Arm & FR now obs on new 12050, but with severe RTTY QRM replacing in-band 25m channel, as of 1/8 (Bob Padula, Victoria) ES from Regional Radio Centres for Autumn/Winter 1977: R. Baku for N&ME in Turkish, Persian, Azerbaijani, Arabic 1300-1715, 1830-1950 on 6135/6110. R. Dushanbe in Tadjik, Farsi on 7275 at 1400-1500, 1530-1630, 1700-1730, 1800-1830. R. Kiev GM 1800-1830 on 7360/6020/5970. In UR: to Eur 1730-1800 on same; and 2030-2100. To Ams 2200-2300 on 15100/11790/7400/7215/7150/6020/5915. And 0330-0400 on 7400/7360/7215/6020. R. Leningrad in RS for fishermen Fri only 2230-2330 on 5950. R. Minsk via Moscow facilities, in Belorussian to Eur, 1800-1830 7420/6175; 2130-2200 7420/6200/5945. R. Riga, Sun 0800-0925 on 5935 in Swedish, Latvian. Latvian W. at 1930-2000, 2130-2200. Swedish Tu/Th/Sa 2020-2050, 2130-2200. Latvian Tu/Th/Sa 2050-2130, all on 5935. R. Tallinn, in Finnish on 6085, Mon-Sat 0915-1000, 1010-1100, 1600-1630, Sun 0800-0915. Swedish 2105-2135, Estonian 2135-2200, all on 6085. R. Tashkent on 9600/9540/6025/5945, 1230-1300 UR, 1300-1330 HD, 1330-1400 UR, 1500-1530 HD. Via Alma Ata on 6135/5035 and unspecified site on 5915, 1230-1330 Uighur. 1430-1500 Uighur on 9600/6135/5975/5915/5035, ditto 1530-1600. 1600-1630 Farsi, 1630-1700 AR, 1700-1800 Uzbek, all on 9550/9540/7145/5945. R. Tbilisi, 1900-2100 Tue/Sun Georgian on 5930. R. Vilnius via Moscow, 2200-2230 Lith to Eur 6100; 0100-0130 Lith to Ams 7215/6020. Vladivostok: Pacific Ocean Radio Station, not Mon/Thu: 0700-0800 to Pac/NAM/FE/ME/S&SEAs 21505/17705/15505/15310/15210/12020/11900/9810/9645/9620/9600/9500/7320/7210/6115/6035/5920/4050/3995/5015/4485. 1430-1530 to Pac/ME/FE/S&SEAs 9810/9665/9625/9620/9610/9530/7340/7280/6145. 1930-2030 to Pac/NAM/FE/S&SEAs 11900/9735/9685/9665/9610/9580/9540/9450/7300/7290/7280/7175/6020/6000/5940/5900/5015, all in RS. Yerevan, in Armenian 0300-0325 Sun/Wed/Thu/Sat to the Ams 9735/7130/6150. Sun 0600-0730 to N&ME 4990; 0800-0900 Sun exc. 0850-0855 FR 15435/12050. 1530-1630 N&ME 6085 1800-1830 to ME 6085; 1900-2100 N&ME 6085. 2030-2100 Eur 7270 not confirmed; 2200-2300 SAM 9480 not confirmed. In Azerbaijani 1300-1350 4990; in Kurdish 1400-1500 4990. In AR, 1500-1530 6085/4990; 1830-1900 6085/4990 (BBC MS Oct-Nov 77) Radiostansiya Rodina to NAM in RS: 2330-2430 ENAM 7150/7215/7290; WNA 11690/11790/15100; 0200-0300 ENAM 7150/7215. R. Moscow daytime Russian to NATL & NAM (incl. R. Atlantika 1300 & 1630; R. Rodina 1400 & 2000): 15485 1130-1700; 15455 1200-1600; 11790 1030-1330; 11735 1530-1730; 9685 1630-2130; 7150 1730-2130 (Dec UHN)

U S A WINB LN-1

TURKEY VOI ES reorganized 1/1; preliminary obs: Turkish for Turks abroad now 0400-2125, ex-2200. On 11800 0600-1200; 9515 0400-2125; 7170 0400-0600 & 1700-2000. New SWAs svc besides EG on 9665 has 1300-1330 UR, 1330-1400 FS, 1400-1500 AR. Balkan svc now on 7270 one half hour later: 1500 RM, 1530 GK to Cyprus, 1600 BG, 1630-1700 SK. To Eur on 7170 2000-2100 GM, 2100-2130 FR (BBCMS 5/1)

TOGO R. Togo sked: Mon-Fri on 3222/6155 0530-0900 & 1200-2300. Sat & Sun on 3222 & 6155, 0530-2300. Daily on 5047, 0530-0803, 1703-2300. 7265, 0803-0900, 1200-1703. In FR, EG, Vernaculars (Randy McCullough, NY)

TAIWAN Central Broadcasting System sked, including sites where known: 3230 10 kW Taipei, 2045-0100, 0345-0700, 0745-1900 in Mandarin. 3335 10 kW Taipei, 2045-0700 Mand, 1045-1600 Hakka, 1600-1900 Mand. 6040 7½ Tamsui 2045-0700, 0745-1900 Mand. 6087 3 kW Taipei 2045-0700, 1045-1600 Shanghainese, 1600-1900 Mand. 7150 100 kW Minhsing 2045-0100, 0345-0700, 0745-1900 Mand. 7250 100 kW Tamsui 2045-0100, 0345-0700, 0745-1600, 1615-1900 Mand. 9690 10 kW Tamsui 2045-0100, 0345-0700 Mand; 1045-1600 Cant, 1600-1900 Mand. 11905 100 kW Minhsing 2045-0100, 0345-0700 Mand; 1000-1130 Mongolian; 1140-1310 Tibetan; 1330-1500 Uighur; 1615-1900 Mand. Per Mr. Chen Mei-sheng, beams on 7250/11905 are 300 and 342° resp; all of these xmsns are thoroly jammed (Geoff Cosier, Down Under DX Survey 12/12)

SWITZERLAND (Cf Jan LN-6) The ICRC xmsns are at 0600-0700, 1130-1230, 1700-1800, 2200-2300 and are in EG on Mons; FR & GM on Weds; SP & AR on Fris. European listeners must enclose an IRC in order to get a QSL (Kenneth DeLong, PA) The 7210 xmsns are from SBC-Beromunster, 150 kW. Beamed xmsns are on Tue of the active week every two months at 0930-1015 on 9560 (150 kW) & 11775 (100 kW) both to Au, and 21520 (100 kW) to Au & SEAs.; 15305 (150 kW) to China & Japan. On Thu 0930-1015 on 21520 (100 kW) to ME, 17830 (150) ME & EAF, 15430 (150) NAF & WAF, 15140 (250) N&CAF, all via Schwarzenburg (THFBS D77 via Australian DX News)

SWAZILAND R. Paralelo Vinte Sete is the PT gmd of Swaziland Commercial Radio, Mon-Fri 0500-0700 & 1730-1830; Sat & Sun 1100-1400; see LN-1 for freq sked (Ginbey, SCDX 20/12) MS 12/1)

SUDAN R. Omdurman has introed a new ES pgm in Galla 1600-1630 Mon/Wed/Sat on 6150/5038 (BBC)
SOUTH AFRICA SAUK Afrikaans service: 0358(Sat 0427, Sun 0458)-0636 on 4880; 0636-1521 on 11885; 1521 to close down on 4880, all to SW Africa. 0358(Sat 0427, Sun 0458)-0521 on 3955, 0521-1621 on 9560, 1621-close down on 3955, all to NW Cape (SABC via Sam Barto, CT) for D77

SAUDI ARABIA HF usage of AR DS from Riyad obs: 0300-0500 11950/9720/9670/7220/5965. 0500-0730 11950/11870/9730/9720/9670/7220/6085/5965. 0730-0830 11870/9730/9670/6085. 0830-0900 11870/9730/9605. 0900-1000 21590/11870/9605. 1000-1500 21590/11950/11870/9720/9670/9605/7220/5965. 1500-1600 21590/11950/9720/9670/9605/7220/5965. 1600-2300 11950/9730/9720/9670/7220/6080/5965 (BBC MS 22/12)

PORTUGAL RDP began new ES in PT for emigrants in Eur on 9/1: 1100-1300 on 15125/11800/9740 (BBCMS 12/1) Non-EG sked of AWR via RTE Sines on 9670: Sun only RS 0500, 0530 Slovenian, 0545 Macedonian, 0600 Serbian, 0630 Croatian, 0700 Arabic, 0730 German, 0815 Swedish, 0830 French; 1630-1700 Mon Ukrainian. At 2100-2130: Sun, Swedish; Mon, French; Tue, Dutch & EG; Wed, Arabic; Thu Greek; Fri, Dutch & German; Sat, Rumanian (ARDXC via RA Japanese DX 8/1)

PAKISTAN R. Pakistan WS to UKOGBANI & Eu in UR & Sylheti 1915-2145 has been since 5/1 on 6235 ex-9465 //7095 (BBCMS 12/1) HS from Islamabad D77: 0045-0210 on 4060, 0215-0415 on 5010, 0600-0603 & 0700-0703 & 0800-0803 on 5060/9545, 1200-1325 5060/9545; 1300-1600 4020; 1400-1615 3330; 1630-1810 3330/4020. Also at 0045-0325 & 0350-0400 & 0830-1100 on 5060, 0830-0945 6030, 0900-0903 & 1000-1005 9545, 1400-1410 & 1500-1615 5060. Link Services from Karachi: 2345-0045 & 1815-1845 & 1915-2145 on 4735 10 kW; 0300-0430 & 0500-0815 on 7265 50 kW; 1330-1630 on 6115 50 kW. From Islamabad 0430-0445 on 9545 10 kW. Regional Services from Peshawar, 10 kW at 0045-0415 (Sun 0445) on 3155; 0600-1415 6080; 1430-1810 on 3155. Quetta 10 kW 0045-0400 (Sun 0345) on 3270; 0600 (Sun 0400)-1030 on 5980; 1045-1345 & 1400-1600 on 3270. Rawalpindi 10 kW 0045-0400 (Sun 0500) 3215, 0600-1100 5010, 1200-1410 3215, 1430-1900 3215. Balti Service 100 kW 0300-0400 & 1130-1330 on 4935. Sheena Service 100 kW 0300-0400 on 4060, 1000-1200 on 5110. HS from Karachi: 0045-0400 4735/7135; 0600 (Sun 0415) 4130 9645/7135; 1145-1330 9645/7135; 1400-1615 4735/7135; 1630-1810 4735/3890 (via Magne PA)

MONGOLIA Ulan Bator non-EG ES: 0730-0800 Mon/Thu Std Ch to China 11855/7262/5055. 1100-1130 Std Ch to China & 1130-1200 Mong & 1300-1330 Std Ch & 1330-1400 Mong & 1400-1430 Std Ch & 1430-1500 Mong all on 5960/4950. RS 1330-1400 Mon/Fri to USSR on 5055/4763/4082. FR Tue/Wed/Fri/Sat 1945-2015 unconfirmed. 2100-2130 Std Ch & 2130-2200 Mong on 6385/5960 (BBC MS 12/77) Ulan Bator DS Pgm-I 2200-0100 on 5055; 0100-1054 11855/7262/5055; 1054-1500 5055/4763/4082 includes some ES pgms as above. Pgm-II 0829-1050 on 6385/5960 (BBC MS 1/78) RUB 1300-1500 on 5958 & 4948v. 11856 no longer heard from 1100-1500. 4080 no longer heard here in Australia either (Mike Willis, 4/1)

MEXICO R. Mexico sked: 1315-1535, 2315-0335 on 15385/9705/5985 (BBC WRC 11/1)

MALTA Adventist World Radio via R. Mediterranean, on 9770 Sun: 0600 Hungarian, 0630 Ukrainian, 0700 Italian, 0715 German, 0730-0800 French. On 9605 0700 Rumanian, 0730-0800 Greek, Sun only (ARDXC via R. Australia Japanese DX pgm 8/1)

KUWAIT R. Kuwait AR DS on 9840 ex-9605 1600-1900 (BBCMS 5/1 & WRC 11/1) 1900-1907* hrd, ex-9605 earlier in Jan; as at 11/1 this OOB offers very good reception (Padula, Melbourne)

KOREA SOUTH Seoul is the one on 11823 from 1100-1300 on. FS (Mike Willis, DUDXS 12/12)

KOREA NORTH The Korean Coastal & Maritime BC Stn Sinchu has been hrd again on 4700 after a 2 1/2 year absence. Broadcasts words of praise for Kim Il Sung and maritime weather reports 1100-1110, 1130-1140, 2130-2140, length varying daily (Takahito Akabayashi, Tokyo SCDX)

KASHMIR R. Kashmir, Srinagar new sked: 3277 0130-0200 & 1130-1705; 4860 0215-0400; 6110 0415-0445 & 0600-1100 (letter received by Satoshi Wakisaka, JADX, via RA DX 25/12)

JORDAN R. Jordan freq sked printed on 1/6/77: 100 kW SW xmtr on 7155 0330-0730 AR omni, 9530 0930-1400 AR omni; 9560 1500-1700 EG to Eu; 9560 1800-1830 Commercial to Eu; 7155 1900+ 2330 AR omni. Another 100 kW: 11920 0330-1500 & 9530 1500-2300 AR directional to the Gulf. 7 1/2 kW xmtr on 7155 1000-1300 EG to Eu; 1430-1730 AR omni (via Sam Barto, CT)

JAPAN Standard freq stn JYJ Moved to Nazaki from Koganei, and changed sked 1/12: 00-05, 30-35 min. Second pulses & 1000 Hz tone 19-20, 49-50 Identifying signal
05-09, ----- Second pulses 20-25, 50-55 Second pulses & 1000 Hz tone
09-10, 39-40 Identifying signal 25-29, 55-59 Second pulses
10-15, 40-45 Second pulses & 1000 Hz tone 29-30, 59-00 Identifying signal
15-19, 45-49 Second pulses All frequencies are interrupted at 35-39 min after each hour. The propagation warning is given in Morse code at the ID times. Frequencies remain unchanged (Takahiro Saito, JADX, via FEDXR) 2500, 5000, 10000, 15000, 8000

IRAQ R. Baghdad non-EG ES: 0800-1030 FS to N&ME 7180/3242; 1030-1400 UR & 1600-1900 FS on 3242; 1530-1630 Hebrew 9550/6155; 1530-1925 AR "Voice of the Masses" for expatriates, 9745. 1900-2000 RS to Eur, unconfirmed; 1900-2100 Turkish 3242; 1930-2030 FR, 2030-2130 GM, 9745. (BBC MS 1/78) On 1/1 broadcasting here was re-organized; preliminary obs: VOM pgm 0258-2320 now on 11785 to Arab Peninsula/Sudan/Somalia; 9550 Egypt/Jordan/Lebanon/Palestine/Syria. On 7240 to Arab Peninsula & Somalia; 6095 Arab Gulf/Jordan/Lebanon/Syria. Also anc'd, 17770 at 0800-1700; 7180 1700-2320. R. Baghdad's Syriac svc 1400-1600 now on 3242 (BBCMS 12/1)

SCADS Southern California Area DXers will meet Sat 11 Feb 10AM-5PM PST at the Valley View School Auditorium, 5361 Sisson Dr, Huntington Beach. For info call or write Don Erickson, 6059 Essex St., Riverside CA 92504; (714) 687-5910 early eves & weekends

INDIA AIR non-EG ES on SW: 0000-0045 Tamil SEAs 9912/7125/6120. 0045-0115 Burmese 7125/6120. 0130-0215 Nepalese 7225/6105. 0130-0430 Urdu Bang & Pak 6160. 0215-0230 Tibetan 9705/7225/6105. 0245-0330 Pushtu 7225/6020. 0330-0415 Hindi Eaf 17705/15140. 0345-0415 Farsi 17387/15185. 0400-0430 Arabic 17387/15080. 0415-0430 Gujarati Eaf 17705/15140. 0430-0500 Arabic 17387/15185. 0435-0445 Konkani Eaf 17705/15140. 0700-0730 Nepalese 9630/7125. 0730-0815 Dari 11765/9675. 0830-1130 Urdu Bang & Pak 9675. 0845-0945 Indonesian 17860/15165. 1115-1130 French EAs 21675/17705. 1115-1215 Burmese 17780/15235. 1130-1230 Tamil SEAs 15335. 1130-1200 Thai 21675/17705. 1200-1300 Sindhi Bang & Pak 7260. 1215-1250 Cantonese 11745/9625/7105. 1230-1315 Tibetan 7125/5955. 1245-1315 Sinhalese 15430/11620. 1250-1315 Std Chinese 11745/9625/7105. 1300-1330 Baluchi Pak 6145. 1430-1830 Urdu Bang & Pak 3295. 1430-1545 Pushtu 3905. 1515-1615 Swahili Eaf 15125/9730. 1615-1715 Farsi 9912/3905. 1615-1700 Hindi Eaf 15125/9730. 1615-1715 Russian 9615/7270. 1700-1745 Gujarati Eaf 15125/9730. 1730-1930 Arabic 9912/3905. 1845-1930 French NSWaf 11880/9755. 2145-2220 Cantonese 7105. 2220-2245 Std Chinese 7105. 2300-2400 Hindi SEAs 9912/7125/6120 (BBC Dec)

FRANCE RFI D77 in non-EG, non-FR: PT 2100-2200 5985/5995/7135. GM 1800-1900 6010/6145. SP 2200-2300 6040 (via D. J. Weber, OH)

EGYPT Recent survey of R. Cairo DS General Svc in AR hrd in the UK: 0400-0500 9455/7075. 0500-0600 11630/9455/7075. 0600-0700 11630/9455/7075/6170. 0700-0800 15210/15175/12005/11785/11630/9495/7075. 0800-1100 15210/15175/12005/11785/11630/9495. 1100-1300 15210/15175/12005/11785/11630. 1300-1400 15210/15175/12005/11785/11630/7075. 1400-1500 17670/15210/15175/12005/11785/11630/7075. 1500-1700 17670/12005/11630/9850. 1700-1800 12005/11630/9850. 1800-2300 9850/9475/7075. 2300-2355 11915/9850/9475/7075. Voice of the Arabs pgm: 0300-0600 9850/7050. 0800-1400 17745/15475. 1600-1800 15475/11785/9740. 1800-2100 11785/9740/7050. 2100-2430 9740/7050 (BBCMS 5/1) Part of R. Cairo's new ES sked as of Dec 1 0045-0200 SP Sam 11715/9740/9475/6230. 1115-1215 AR S&SEAs 17920. 1130-1200 Thai 21465. 1200-1345 Indonesian 21465. 1330-1430 Bengali 17920 (BBCMS 12/1)

CHINA R. Peking using new 5000 for Lao 1430-1455 etc //5030 (Ugusa & Wakisaka, JADX 25/12 via FEDXR) Chinese service of Kizang (Tibet) PBS is noted regularly on 5935, and irregularly in // on either 6070 or 7085 kHz (Hiroyuki Nagase, FEDXR 29/12) The 1300-1355 & 1400-1455 Uighur & Kazak resp from R. Peking DS minority rang pgms are hrd on 7080 + 9920/8565 (BBCMS 22/12)

BURMA BBS DS weekdays 0030-0230 7185; 0330-0730 9730; 0930-1600 5985. Since 10/12 SSB 5189 obs // (BBCMS 22/12)

BELGIUM RTB FR SW sked 25/9/77 to 1/4/78 (subject to change). When two freqs are given, the first is 100 kW, the second 250 kW. SEAs: M/W/F/Sa 1305-1330 21690. SEU weekdays 1500-1645 5965. All the rest are to Af: 0500(Sat 0530)-0615(Sun 0645) 9615/11850. 0630 (Sun. 0700)-0735(Sun 0845) 17765/15210. 1000(Sun 0900)-1300 15210/21460. Mon/Wed/Fri/Sat 1305-1330 15210/17740/21460. Sun 1330-1630 15210/21460. Weekdays 1500-1645 21460. Daily 1700-2000 15230/11735. 2015-2215(Fri & Sat 2230) 9730/11735. Involved are relays of DS nets I & II as well as International pgms (via Sam Barto, CT)

MISCELÁNEA RADIAL **VIETNAM** R. Son La on 6332 1100-1430*; good. R. Bac Thai on 7087 at 1300-1400+ in Viet. Loud; new power? Hanoi on 6450 //10060 to 1630*; Hanoi on 6425 //10225 to 1600*; both loud. Hanoi settled on 4945 at 1100-1500+ no longer drifting around (Mike Willis, Victoria, 4/1)

VENEZUELA La Voz de Caroboba (sic--should be Carabobo =gh) obs on 4840 (BBCMS 5/1) News?

U S A (Cf Jan LR-D-2 11780) Correction to my assumptions about WYFR. Arthur Thompson assures me WYFR does monitor their own signals off the air, as they are required to do, using type-approved equipment, Belare AMM-2 monitors. These monitors have straight demodulation, and the FM warble cannot be detected on them, since there is no local oscillator to beat against, but it does show up on typical consumer IF superhet receivers. There was a less than 1% chance that FM would develop in the signal. All eight synthesizers WYFR has for the six transmitters had their FM-null adjustment set by the manufacturer; and this problem was just a fluke (Arthur Thompson, WYFR) Glad to set the record straight. It seems FCC is to blame for not requiring monitoring on standard superhet receivers! (gh)

AFRTS-Washington almost died as a SW station. On 8/12, AFRTS overseas stations were advised that SW would be discontinued as of 1/1 at 0500, because VOA had requested reimbursement for use of SW xmtrs, effective 1/10/77, after having provided them at no cost to DOD since 1966. A Review indicated that the vast majority of US Forces overseas do not receive AFRTS-W news via SW, but by superior quality cable and satellite circuits. (via Rita M. Vernetti, Marshall Islands) The impending execution was announced 19/12 at 1835, and further developments were given at this hour on Program Notes, such as on 30/12 that there had been an extension to 17/1/78 at 0500 GMT (Louis Goldstein, MA, Review of International Broadcasting) On 5/1 I learned from an Armed Forces source that the odds were 9:1 that SW would not be closed down after all, due to the large amount of listener protest already received; and this was revealed on my 8/1 RCI DX Digest report, and confirmed on the 15/1. Sure enough, 0500 17/1 came and went, and AFRTS continued as usual thru our closing (contd.)

date of 23/1. Meanwhile, press reports continued to predict a 17/1 closedown (gh) AFRTS-W will be discontinued on SW starting Monday 'because of costs and the increasing use of satellite transmission', a US DOD spokesman said Thursday. The VOA, because of its own budget cutbacks, must now begin to charge a \$400,000 yearly transmitter rental fee, after supplying them free for more than 30 years. The US DOD spokesman said less than 5% of overseas armed forces personnel use SW receivers. Ray Briem on KABC talkradio protested the cut. L.A. county Supervisor Kenneth Hahn said the board of supervisors feel that \$400,000 is fairly inexpensive when you consider that 5% represents some 60,000 military personnel who will be unable to receive AFRTS. That \$400,000 annual cost works out to around 76 cents a minute (James Brown, Los Angeles Times, 14/1 via Pete Grenier, CA) Paul Harvey has been publicizing the proposed cut. He speculates the reasons may be a power struggle with the VOA, 13/1 (Brett Saylor, PA) Any protest by domestic SWLs, or non-military listeners overseas, could be counter-productive. Let's hope AFRTS-W is now on SW to stay (gh)

On 19/12 I had the most startling piece of DX in years. Around 0910 I was tuning past 1610 kHz when I noticed a weak carrier. I soon realized it was a Traveler's Information Station for which these freqs were recently authorized. By 0925 the signal had risen to S5 and thru heavy QRN I heard "Welcome to IOWA!"; two continuously repeated announcements about speed limits, rainfall, etc. Still there the weak and fading when I tuned out at 1020 (Jerry Starr, Youngstown OH, NRC DX News) 1610 (and 530 kHz) allocated exclusively to TIS by FCC. With "monopole" antenna and 10 watts, range is approx 10 miles (5 mi radius). To prevent QRM, stns should be approx. 12 mi apart. With 'induction' antenna (cable type) & 5 watts, range is limited to a particular section of highway (notes taken from the Federal Highway Adm movie "Highway Advisory Radio", by Jack Jones, MS) This is "SWBC"... (gh)

WTMA Charleston SC, hrd well lately on 2500 under WWV, 2 x 1250, IDed by Gerry Bishop & me during 30/12 all-night DX session (Charley Hoffman, PA)

Charleston SC marine telephone stn noted on 2566 accidentally relaying R. Huayacocotla 22/12 at 0012. At 0015 Charleston began its nightly wx BC. Thruout this period, the mod. on 2566 was for all practical purposes standard AM (SWNS) I heard this about a year ago, but that it was from another marine op, also monitoring 2390 for traffic (gh)

TURKEY Istanbul Polis Radyosu, tentative on 6320 21/11 only from f/in 1450 to 1456*. No anmts, just ME mx; listed on 6325 to 1500*. 6340, Turkiye Polis Radyosu, excellent level 1300 past 1500 mx, anmts in Turkish (Geoff Cosier & Mike Willis, DU DX Survey 12/12)

THAILAND Radio stns have been instructed by the P.M. acting in his capacity as Chairman of the National Radio Station Administrative Board, to refrain from doing anything that will jeopardize the government's rapprochement with its Indochinese neighbours. All stations will be asked to comply with this by broadcasting news and commentaries consistent with present govt policy. The Prime Minister also said the Public Relations Dept. was planning to increase power of its stations to match those in neighbouring countries (Bangkok Post 14/12 via BBCMS 22/12) Is it my imagination that RT on 9654 has increased power? Certainly is giving first-rate reception at 1100 in EG (Mike Willis, Victoria, DUDXS)

TAIWAN Most of the CBS xmtrs (cf sked LN-3) were in fact supplied by the CIA. Powers range from a rather paltry 3 kW to a high of 100 kW, using aerials of unknown quantity and description (probably curtain arrays), at three different sites: near the capital of Taipei; at Tamsui (approx 20 km N of Taipei); and at Minhsiung, east of Kaohsiung, on the southern part of the island. Minhsiung & Tamsui are used exclusively by CBS, Taipei also by VOFC, which has two sites not used by CBS at Panchiao and Kaohsiung. The S 1972 THFBS also gave for CBS sites at Lungyon and Tsoying, presumably no longer or never in service (Geoff Cosier, Down Under DX Survey, part of a much longer article on CBS; see PUBLICATIONS) GRAM)

SYRIA The HS of R. Damascus noted 9 & 10/1 on 15165 in AR 1800-2000 (Bob Donly, SC, SPEEDX-

SWAZILAND TWR on new 17745 African to 1930, then FR (SWNS)

SURINAM Jumping back and forth again, hrd 11/1 on 4850v/725, both good (Pitt McNeil, DC)

SPAIN "Spanish Foreign Radio" as RNE/RTVE now IDs in EG, noted 15/1 at 0252 on 6065 ending DX pgm, giving new address of P O Box 150139, Madrid; saying sunspots will peak in 1982 at only 55! (gh) Since 2/1, RTVE ES IDs as "Radio Exterior de España" (BBC MS 5/1)

SOUTH AFRICA R. RSA anc'd 10/1 that it would be using 3 additional SW xmtrs from the next month, part of R. RSA's normal growth (BBCMS 12/1 which adds: these were due to become operational 6/11/77, but, construction delays) R. RSA had a special all-night program for NAM 31/12, opening early at 2153, on late past 0230, inviting phone calls at 714-0068. Many calls from NAM were put on the air. Steven Freygood on CBC said the total was 130. There had been no advance publicity about this, so it pays to check around for such specials on holidays (Glenn Hauser, Review of International Broadcasting) The ethics of the way R. RSA subsequently promoted this show will be discussed in the Feb. RIB (gh)

SOMALI REP. Hargeisa has gone from 7120, during period 1400-1500 at least; remains on 11643 at this time (Mike Willis, Victoria, 4/1)

POLAND Polish Pathfinders' Station heard on 7207 at 1430 with pop music (Noel Green, UK, BBC WRC 18/1)

PHILIPPINES PBS hrd at 1030 on new 5990 (Stig Hartvig Nielsen, Denmark, DX Fokus via DSWCI (CF Dec LN-5) I finally pulled an ID out of the 9497 mess, so wrote FEBC, and their reply dated 29/11, received via air 12/12: "The frequency 9497 you've heard is operated by FEBC on 9500 kHz at 1100 GMT using the Tribal language for SEAs." Signed by Zeny Visca, QSL Secretary. Appears they don't believe they're on 9497, but I'm not about to waste time and energy explaining to them they're on 9497 and not 9500 (Mike Hardester, Japan)

PERU R. Continental, Arequipa, currently on 9690 (BBC MS 22/12)

PARAGUAY R. Chaco Boreal noted 19/12 on 10415 0230 past 0400, apparently relayed by ANTELCO with fairly old American rock tunes (absolutely no SP lang mx at all!) on LSB (David Crawford, FL) That's 'trauc' (gh) R. Nacional del Paraguay with several IDs, also announcing 49m, MW and FM: talk about Partido Colorado, also Guaraní talks, 2310-2340, SINPO 24222 15/11 (Jugan Lohois, Bentota beach, Sri Lanka, UADX)

PAKISTAN R. Pak HS hrd in various langs 1300-1500 on 4021; in Burmese 1100-1200 on 17793 (Mike Willis, DUDXS 12/12) On 4935, R. Pak in unID lang 1300-1330*. Last Nov it was 1245* (Satoshi Wakisaka, Japan, DUDXS 12/12)

NICARAGUA La Líder is really "La Voz de la Victoria" in Managua, MW stn on 1100 with harmonic on 2200. "La Líder" is their slogan. Bruce Schoenfeld informed me of this via the ECDXA Newsletter (Bob Pinchuk, NJ)

NEW HEBRIDES R. Vila, 3945, FR, island mx, ho hams around for a change, 0845 28/12. I guess this is pretty rare on the East Coast, huh? (Doug Snyder, CA, TDXN)

NETHERLANDS ANTILLES From 1/1, the R. Nederland MW service via PJB Bonaire on 800 kHz was dropped for reasons of economy (WDXC Contact) Conveniently, I am typing this at 2300 21/1, and no RN, but TWR's SP "R. 3:16" pgm, and at 2330, TWR EG and 0030 PT (gh)

MÉXICO R. Huayacocotla SP still heard here often on 2390 till 0206* (Neal Perdue, AL, 7/1)

MALAWI Blantyre hrd well on 7130 at 1600, much mx and anmts in Chichewa (Willis, Victoria)

LIBYA PRB noted on new 6200 8/1 1955-2130+, AR //6100 etc. First that it Syria, but no EG 2030-2200; also hrd PRB recently on 9650 (Richard Stoller, NY) LBS hrd in AR on old 6185 at 2130-2253*, diff pgm than 6100/9500 outlets (David Kernick, Herts., UKOGBANI)

LAOS FS has departed from both 7070 and 7145 (Mike Willis, Victoria, Australia, 4/1)

KUWAIT RK noted 16/12 in AR at 1850 on new 9605 (David Kernick, UK) Cf LN-4, since moved to 9840 (gh)

KOREA SOUTH Per a letter from FEBC Philippines, they are using 2 xmtrs outside that country--1020 kHz in Okinawa and 17805 in South Korea (Paolo Corsetti, Jan DSWCI) ??? (gh)

JAPAN FEN SW outlets went off the air at the beginning of Dec, and re-opened on 24/12 (Sei'ichi Hasegawa & Yoshiaki Hayashi, FEDXR)

ISRAEL (Cf Jan SPEEDX-16, your comments under NORWAY 21'03) About not enough stations using the 21 MHz band to NAM. IBA has since 2/12 been there at 300 kW to Eur and (mainly E) NAM 1200-1300 in EG/FR on 21500. Results excellent in Eur, fair in NAM, despite the darkness season. This expected to continue indefinitely probably shifted to 21495. However, the band is crowding up, and you can expect more use by jammed services, so freedom from QRM won't last forever. Even 21495 will have USSR 21490 QRM (Larry Magne, PA) The EG news dept of IBA is boycotting the services of the Hebrew news dept of IBA, by refusing to carry detailed news about the Cairo talks. This resulted from IBA's decision to send only Hebrew and Arabic-department newsmen to Cairo (Jerusalem Post, via Magne)

IRAN R. Iran on new 9720 for Farsi HS, noted 2325 //9022 (David Kernick, UKOGBANI)

INDONESIA RRI Jayapura on 4981 from 0800 fade in to 1400* //6070 (Jim Young, CA, 14/1) RRI Manokwari on 6150 to 1400*; RRI Dfili gongs and ID at 1400 on 3120 (Michael Willis, Victoria) RRI Padang has an additional address; P.O. Box 77, Padang, Mgr. is Mr. Djamalul Abidin Ass. One of his secretaries is Ain Zainuddin, a stamp collector. Latter sent me a greeting card but no QSL since I sent them a report 2 years ago (Pitt McNeil, DC)

Jakarta radio reported that on 15/12 the Director General of Radio, TV and Films said the Information Minister had reaffirmed that the Indo Commercial Radio Broadcasters Assn (PRSSNI) is the sole professional comm'l radio BC organization in the country. Non-member stations of PRSSNI will not receive govt recognition or have access to facilities. The Dir. Gen. added he hoped commercial stations would relay RRI news. Each must soon obtain an operating permit so as to have legal status. He said the use of freqs outside those allocated by the ITU is illegal and will be treated as such. The illegal use of any frequency would interfere with other services and invite protests from abroad (BBCMS 22/12)

GUYANA UnID first hrd 27/12 on 3137, from band open 2300 to 0258*, last hrd 5/1; also on 29/12 at 0800-0900 tune out. Always in EG, but couldn't understand ID. Thought I heard Guyana mentioned in New Year's Eve cricket (?). Could it have been a Georgetown stn testing on a new freq? (Bob Donly, SC, SPEEDXGRAM) Presumed GBS hrd on approx 3150 29/12 and 1/1 0100 past 0500: rock mx, anmts, conversations with studio visitors. Horrendous modula-

tion, only thing understandable was a GMT -3h time check (David Crawford, FL) Hrd 31/12 on 3137, Caribbean EG 0235, ID at 0253* as GBS Cuyana, giving 2 MW freqs, usual 3.29, 5.95 MHz SW. Couldn't tell whether actually on 3290, but this 3137 doesn't work out as a harmonic of any known MW freq of theirs. Also there next night 1/1 at 0342. (Glenn Hauser, visiting Puerto Rico) Possible fundamentals of 3137 would be: 1568.5, 1045.7, 784.2, 627.4, 522.8.

EGYPT Besides 6230 to NAM, R. Cairo noted on other new freqs-- Voice of Arabs hrd 2340-0031* on 9740 //7050. Gen Svc in AR hrd at 0610 on 9620 //7075. Voice of Arabs also on 9770 and 0345. Swahili now on 11890 at 1530-1730 (David Kernick, UK) Cairo noted 19/12 on 9475 at 0200 as usual but emitting spurs at 9440, 9405, 9370, 9335, 9300, etc., with the strength of the spurs progressively weaker with decreasing frequency (David Crawford, FL)

DOMINICAN REPUBLIC On 21/12, R. Clarín, 11700, claimed its SW was operating without any financial support whatsoever. Meanwhile, //4850 hrd back on the air (SWNS) 4850 noted back on 7/1 at 0035-0200+ with LAM mx, many IDs (Neal Perdue, AL) On "This is Santo Domingo" 10/1 at 2322 Rudy Espinal was begging for samples of NASWA, SPEEDX, etc. to prove to tourism dept. that they're getting out, so they can get goodies to send to listeners. He said R. Clarín has no government backing; they are paying for the international service themselves, since they happened to have a 50 kW SW xmtx they hated to see go to waste. On 17/1 at 2337, Rudy said he would be in Miami 18-20 Jan, acting as translator for D.R. Pres. Joaquín Balaguer, necessitating reruns of his program. Said he wanted to meet Miami-area listeners and told how to contact him there. Said would like to do a program in German if R. Clarín can get a reliable signal in to Germany; perhaps on a seasonal basis. Well, if our friend Rudy is a personal acquaintance of the president, surely R. Clarín has some close ties with the D.R. govt. You don't hear it in English, but in SP programs they really build up Balaguer. Continuing xmtx difficulties, missing the Sat 14/1 pgm after inviting me to phone them for an interview on the air; and missing the Sat 21/1 pgm (gh)

CHILE R. Nacional de Chile hrd 13/12 on new 9675 with DS 2200-2305* sudden cut-off (David Kernick, UK) Radio Free Chile heard after 0100, big signal on new 11900 (Ruth Vollrath, MO) Checked for this 18/1 at 0142 and didn't hear it, tho 11704 was in (gh)

CUBA RHC now sending out full-color pocket calendar card with likeness of Dr. Fidel Castro Ruz, instead of lots of B&Ws of lesser revolutionaries as in previous years (via Louis Goldstein) During a layover at Miami AP, I tuned around on the FRG-7 I was carrying, finding on 2960, SP at 0053 5/1, listing 'empresas'; freq a bit low compared to 5960. At 0204 gave a CM-- ID and slogan like "R. Magay" (?), and said it belonged to ICR. Presumably 2 x 1480, where none listed in WRTVH, but could be 4 x 740 (gh)

ZONGO RTVC hrd in FR at 2020 on 9610. Cheers! (David Kernick, UK, 15/12)

COLOMBIA Per a report originating with a Colombian ham and relayed to us by an Elementary Electronics reader, R. Súper de Medellín, 6000a kHz, has been destroyed by fire. R. Cúcuta is a new stn on 1170 with harmonic hrd several times on 2340 as far north as Canadá to 0400v*. However, in the past a Venezuelan, R. El Sol at La Fría, less than 50 miles from Cúcuta, also had a strong harmonic on 2340, but this is definitely Colombian (SWNS) R. Súper de Bogotá on new 4785, either 24h or very late, noted 0600 1/1 ff (R. Stoller, NY)

CAPE VERDE Don't you believe that just because you hear mx on 3885, you've logged RCCV. Some hams on the channel say there's a musically-minded man with a ham rig on the freq. If you listen closely to this illicity, you may note either that there are no amts, or if any they're by an American BCB DJ (Richard Stoller, NY)

CANADA Here's a strange: CHU hd on 9173.0 at 0420+ 15/1; best tuned as USB due to QRM, but there is a carrier so AM mode (David Walcutt, IL) New freq, or spur? (gh)

CAMEROON Nat'1 Svc hrd from Yaoundé on 9745 at 0600 FR; good level, 100 kW (Willis, Aust.)

BURMA (Cf Jan LN-4) UNID stn on 4980 is possibly operated by Nat'l Democratic Front, which includes 9 minority rebel groups--Karen National Union, Kachin Independence Organization, Lahu Nat'l Progressive Party, Union Pao Nat'l Org., Kayan New State Party, Paraung State Liberation Org., Arakan Nat'l Lib. Party, Shan State Progressive Party... Six langs of these groups are included in BCs of the stn. Karen is missing, but it is because Karen has own stn "Voice of Kawthulay" in Sgaw Karen and Pwo Karen (cf CLANDESTINE CRANNY)... From the langs used, for me it is supposed the stn is operated by NDF and located somewhere in the liberated zone in Karen State or near that region--as well as "VOK". However, why doesn't the station ID, and why do they carry news items previously broadcast by BBS? This is all guess-work and may be incorrect. Oh, the NDF is anti-Burmese govt and anti-Burmese Communist Party (Isao Ugusa, FEDXR 29/12)

BRAZIL R. Educadora Rural, Coari, Amazonas, barely audible on 2490, some fade-ins, listed 250w; 31/12 0130 rauc mx, ID seems just "R. Coari" (koh-ah-REE); off at 0226*: 1/1 checked with ID at 0229, maybe stayed on late (Glenn Hauser, PR) Hrd from t/in 2305, pops, choral, ID 0033, 0230*, very good by then and could not believe 250W (Terry Krueger, FL, 8/1) Idif. Acreana, registered on 4885, hrd on 4735. R. Ed. Parnaíba, 500 W on 3365, is hard to hear even in Recife, whilst R. Congonhas 3385 has a good signal (Roberto Medina, DX Clube do Brasil, via R. Nederland's "Rádio Atividade" PT DX ogm 19/1 via gh)

BOLIVIA R. Frontera, Yacuiba, Chaco Province, now on 4805 plus 930 (BBCMS 5/1)

ARGENTINA (Cf Jan LN-7) As soon as I called you, the 9115 stn gave out 3 IDs. It should be noted that Dan Robinson heard this one first, for about 7 weeks before I did, so he deserves credit for it; and it also shows the game coverage was not a one-time affair (Pitt McNeil, DC) I noticed it once since (gh)

AFGHANISTAN RA giving good reception on 4085 around 1400; and 3391 at 1300 also well heard, both in local programming (Michael Willis, Hampton, Victoria, Australia, 4/1)

UNIDENTIFIED 17631 A curious one at 1300 with nx in Farsi or some such language, rather weak on the whole (Mike Willis, DUDXS)

9555 (Cf Jan LN-10) This is RTVG, Gabon, on new freq (Kernick, UK) 2 x 4777! (gh)

5050 Time stn with pips every 5 secs; no anmts; f/in and non-appearance in local mornings suggests Euro QTH (Pitt McNeil, DC, 11/1)

4872 at 1218-1330* only 15/12, in Meo type lang, closed w/out anmt, possible Vietnamese stn; not since (Isso Ugusa, FEDXR 29/12)

4844.5 Suspect R. San Ysidro, Honduras 11/1, clear of Mauritania after 0000-0133:10* (Whit)

4840 African 2/1 fair sig 2103-2107*, seems romance lang, doubt Brazil; Bukavu? (Whitacre)

4760 a real live Hauser-type harmonic! Giving nationwide wx 1230, frequent mentions of Waynesboro. Beats me since it wasn't there at 1200 (Perry Ferrell, NJ, TDXN 20/12) Would have to be 4 x 1190 (Phred Heutte, TDXN Ed.) Or 7 x 680! On neither freq can I find any stn listed in the NRC log in a Waynesboro, nor near such a town, checking atlas and PO list

4668 another mystery time signal, hrd often after 0100; open carrier except for SP TC (gh) on the minute in GMT. Ideas? (Pitt McNeil, DC)

2810 SP BC stn at 0307 15/1; all I could catch was an ad mentioning "9 de la mañana". Possible funds: 1405; 936.7; 702.5; 562, none of them very likely (gh)

CLANDESTINE CRANNY R. Sandino. Cuban news agency Prela reported 8/1 details of a clandestine station which broadcasts from somewhere in Nicaragua. It calls itself "YNS, R. Sandino, the official voice of the FSLN", (Ed. Note: the Sandinista National Liberation Front) and can be heard in the 41 & 49 metre bands. One of the stn's BCs starts at 0430 acc. to the Prela report which added that news bulletins have referred to guerrilla activities carried out by Sandinista groups in northern Nicaragua close to the Honduran border (BBCMS 12/1) No luck finding this one so far (gh)

R. Abdala, 7085, hrd in TN 25/12 as in Jan LN-10. A week later I was in Puerto Rico, and couldn't hear it. However, when I arrived at San Juan airport, a guy from Agrupación Abdala was handing out handbills discouraging travel to Cuba. He said the xmtr was in Florida and that they hoped to put another one on from Central America, maybe Costa Rica or Guatemala. Gave me this address: Ángel Estrada, Publicación Periódica ABDALA, P.O. Box 243, Elizabethport Station, Elizabeth, NJ 07206; reported (gh)

"WJVR", pirate on approx 1620 kHz, hrd 12/1 0600-0700 with excellent sigs; Hal Hayes saying this 'free speech stn' was in NYC. Used the old "WCPR" phone system; people called in from as far as Albany, Philadelphia and central CT. After he went off the air, I called and spoke with him about WJVR (you mean WJVR? gh). He has an elaborate studio including audio synthesizers, accounting for superior audio. Said he was connected with the old WCPR, he is WDDX and WFAT. Mentioned a friend's station, "WGOR" using a portable cassette machine and the stock mike for audio! He seems to be a great guy who is interested in the listeners... and he QSLs (James Mulvey, Seaford NY)

UnID on 1615 kHz with apparently non-stop Greek-Macedonian mx 2355 tune in 25/12 past 0330. Fair to mostly poor reception at SWNS HQ. Similar to a stn which operated from Hamilton Ont area in 1974-5, subsequently written up in Elementary Electronics. But this time modulation somewhat distorted; hrd again 0203 tune in 31/12 (SWNS, Crystal Beach, Ont)

"WSLD - Solitary Radio" hrd Sat 7/1 on 4830.6 2040-2140+, playing moldy-olies; southern-accented DJ in often with IDs, wx (temps 5° warmer than DC), and slogan "bringing you the best in oldies but goodies." Good strength, bad QSB, decent audio. Guess it's in VA (McNeil)

Free Radio Broadcasting Co., on 6213 0932-1034 1/1: pops, golden oldies, accented EG DJ, IDs for FRBC, TCs, freq anmts, addr. in Denmark. Said would stay on to 1200. Fair at first but poor by 1034. All tnx to phone call from Dan Robinson! (Pitt McNeil, TDXN) Congrats! A very rare logging of a 6 MHz European pirate in NAM! (gh)

ABC England will suspend for 6 months due to 'staff shortages' and for equipment overhaul, but the DX bulletin will still be available, says Euro Music R on 6265 (Keith Devereux, WDXQ)

The "Aida" Station (cf Jan LN-10 unID) Hrd it on 4740 twice, both on rather good African afternoons. 9/12 IS 2026-2033 lost in noise; 23/12 2030 tune in -2036 when suddenly disappeared, when Get this--man in SP or PT reading off in monotone, one-digit numbers. Yep, a numbers stn. Is the March from Aida a patriotic song, anthem? (Richard Stoller, NY) No.

I heard the same stn on 6675.0 3/1 at 2313-2320* just with music over and over; no numbers (Glenn Hauser, PR) Re the 4740 uNID in Jan LN-10. Sounds like the stn I heard on 4740v while in England Oct-Nov 1976. The IS was the trumpet fanfare from the Grand March in the Verdi opera "Aida"; the 8 seconds on, 5 seconds off pattern is about right. It is definitely a somewhat amateurish clandestine operation. It may not be audible in Am thru the QRM, but the last note of the IS descends in pitch as if it were recorded from a phonograph and the recorder turned off too soon; in a Slavic lang and heavily jammed, probably by USSR, just as soon as a speaker comes on at 2030. Certainly somewhere in Europe; the signal was strong and clear on my XCR-30 with only the built-in antenna. Strong signal + high powered jamming is puzzling, since you can scarcely hide a hi-power xmtr in WEu for a year without someone finding it; my guess is Albania or Yugoslavia. Hope this info helps and that other NASWA members will be able to ID it (Robert Clark, AZ)

Voice of the Free Sahara pgm in AR & SP, presented by Polisario, transmitted thru R. Algerie facilities, recently traced on 575 kHz 2300-2400. Last IDed on 7/10; the 575 kHz xmtr is in Bechar, a town in western Algeria near the Moroccan border (BBCMS 5/1)

Voice of the People's Front for the Liberation of Eritrea pgm is on Mon/Wed/Sat, while the Voice of the Eritrean Liberation Front, is on Tue/Thu/Fri/Sun, at 1500-1600 via Omdurman, Sudan on 6150/5038, in AR and Tigrigna (BBCMS 5/1)

R. Tanzania cland pgms sked: 0415-0430 Sun Voice of Namibia; Wed PAC=Pan African Congress; Sat ANC Programme, on 15435/6105. 1815-1830 Mon/Wed/Fri ANC Pgm; Tue/Thu/Sun PAC Pgm; 1815-1845 Sat Voice of Namibia; 1830-1845 Sun VON; 1830-1900 Mon-Sat VON; 1845-1900 Sat PAC, Sun ANC; all on 15435/6105 (BBCMS 1/78, per R. Tanzania)

Voice of Cyprus anc'd sked on 755 kHz is 0500-0700, 0900-1200, 1500-1700; site believe in Anamur, Turkey. There is a weekly GK pgm Tue 1615, "Last week in the Greek Cypriot Community" (BBCMS 5/1) Neil, TDXN)

Voice of the Communist Party of Turkey, 6200, very good signals 23/12 *0806-0841* (Pitt Mc-

Voice of Lebanon (Cf Jan LR-C-1) on 6550, La Voix du Liban, fantastic sigs at 1410 with rauc and disco mx; FR ID 1420, AR anmts too; Peking QRM (Geoff Cosier, Vic., DUDXS) VOL heard daily at 1400 in AR, FR, EG (Mike Willis, Australia, 4/1)

Voice of Palestine, Voice of the Palestinian Revolution, believed to be in Lebanon, ops on 1508 (nom. 1520) kHz, in AR 0400-0500, 1400-1500, 1800-1900 (BBCMS 12/77) The 1400 now lasts to 1600. The 0400 & 1800 were announced as 'experimental' (BBCMS 5/1) A Qatar News Agency report 4/1 said Iraq had decided to close down the VOP stn supervised by Abu Nedal, the former dissident of the Fatah organization. QNA, quoting the "Al Arab" newspaper said the VOP pgms would be resumed from Iraq but under the supervision of the PLO. However, a BC from the Iraqi-based VOPVOPR 4/1 emphatically denied the suspension (BBCMS 12/1)

Voice of the People of Burma hrd on 5110 at 1128 banging on a hollow log, wailing. 1130 news (?) in Burmese, best ever 1/1 (Pitt McNeil, DC, TDXN) Since 1/1 the 6304 kHz xmsns have been at 1400-1500; in Dec it was at 1030-1130. Timing varies month to month, but no pattern has so far been identified (BBCMS 12/1)

Voice of Kawthulay (Cf Jan LN-11) Often transliterated as "Kawthoolei", originally Karen words meaning 'full of peace' or another book says 'blossom land'. But usually the word indicates the 'Karen State' itself. The Burmese ID actually means Kawthulay Broadcasting Station, or Karen State Radio, rather than "Voice of" Kawthulay. Stn appears to be operated by "Kawthulay Govt", the govt of Karen National Union, which has the biggest military power of all the 9 minority rebel groups of NDF. Karen State is a small one in SE Burma, but the Karens are the largest minority in Burma, many living outside that state. Such a station was heard 17/11 at 1304-1320 on 4880 in EG with pop songs including "I'm Leaving It All Up to You" and "Mama Mia", but not IDed (Isao Ugusa, Japan, FEDXR 29/12)

Radio Tanafo, New Hebrides says its evening xmsn is still suspended, only on in the local mornings. But they plan to restore eve BCs eventually, and have pgms in EG and FR for their 'overseas friends'. (John Campbell, Australia, DUDXS 12/12)

FUTURE PLANS YUGOSLAVIA When R. Yugoslavia is fully equipped it will play a significant role in providing info for Yugoslav workers abroad in cooperation with other Yugo domestic stns. RY's audibility is expected to be good in all Euro countries and even much further afield. (BBCMS 5/1)

(UNITED NATIONS) BBC Review of the British Press 24/12 included a report from the NY correspondent of the Daily Telegraph: "The UN will be seeking cooperation of radio stations in both WEu and communist countries to help relay anti-apartheid programs to South Africa. BBC, R. Moscow, Peking Radio, and stns in France, the Netherlands, West and East Germany will be asked to transmit one hour of anti-apartheid pgms each day" (Kim Andrew Elliott, MN) 15 min each in EG, Afrikaans, Zulu and one other dialect. It is hoped to begin in March, and a 146,000-pound annual budget has been voted. The measure was voted for by Britain, but was part of a large anti-apartheid resolution, and the item received scant attention. The MW stns of Mozambique, Botswana and Zambia are also to be asked for air time. (Contd.)

A BBC spokesman said they had not been approached by the Foreign Office and said "We would look into the idea only when we are told about it." A UN Radio official said it would be the first time they had broadcast to a specific country without the concurrence of the country's government (Mick Kitchener, Jan WDXC Contact) Fugitive South African editor Donald Woods has been invited to make the first UN broadcast using the new facility via Botswana and Mozambique. An annual budget of US\$270,000 has been approved by the UN for this campaign, which is part of the stepping up of efforts by the UN in its movement against apartheid (Bob Padula, based on a report in the Melbourne Age newspaper 11/1) THAILAND LN-6

SWITZERLAND SBC will start transmitting to NAM in May on SSB. Also said that tests on SSB results were very good. More info in next pgm (Swiss SW Merry-Go-Round 14/1, via Pete Grenier, CA) All they said was that PTT had approved SSB tests to NAM and would probably begin in May, for a year. Tnx to everyone who returned "SSB on SBC" questionnaires; and no more of them are needed now (gh)

SWAZILAND TWR is getting two more 100 kW xmtrs to reach SAs, N & WAF (Rieth(?), GFR, SCDX 10/1)

SRI LANKA Deutsche Welle just announced that they have the final 'go' for a relay stn in Trincomalee, expected to be ready in a year. We can expect two 250 kW xmtrs to beam to Asia & Oceania (Oliver T. Goonawardena, UADX 15/12) Per the W German news agency DPA, DW's relay stn will cost between 25 & 30 megamarks. At present DW has 28 xmtrs and a staff of 1330, increasing to about 1600 in the next two years (BBCMS 22/12) TWR will not be able to use its new MW stn here to transmit in EG, Sinhala or Tamil, as the law does not permit anyone but SLBC to broadcast in these languages (The DX World Monitor, Sri Lanka; see PUBLICATIONS) I should think this law would hamper DW (George Wood, SCDX) Well, VOA-Colombo gets away with EG, see WRTVH-77, so maybe inapplicable to SW? (gh)

SOUTH AFRICA (Cf LN-6) R. RSA mentioned on its NYE special that the 500-kWers wouldn't be on until May 1978 (gh)

MONACO Powergame: TWR is planning to build a new 500 kW xmtr in order to be able to reach its listeners because of the increasing number of stations introducing powerful transmitters (Per Olsen, Jan DSWCI SW News)

LATIN AMERICA Elections often open up interesting DXing and SWling possibilities. Check the map above for dates (gh)

KENYA No plans exist at the moment to start an external broadcasting service. Present plans are geared to provide an effective nationwide domestic broadcasting service, per the Minister of Info & BC (VOK 14/12 via BBCMS 22/12)

COLOMBIA Rdif. Nacional has two 50 kW and two 20 kW xmtrs. ENTEL plans to install five 50 kW xmtrs in the next year, to use the most favorable frequencies possible (Carlos Arturo ---, R. Nederland Espacio DX-ista 21/1 via gh)

BRAZIL Brasilia will soon have a 100 kW stn on 4845, by far the most powerful on the tropical bands here, to cover remote areas lacking local radio, such as Fernando de Noronha (Roberto Medina, on R. Nederland Rádio Atividade, 20/1 via gh)

ASIA Adventist World Radio is to operate its own stn in Asia by 1979; site is not yet decided but will consist of two 100 kW and one 250 kW SW xmtrs (Allen Dean, Jan WDXC Contact)

DX PROGRAMS UKOGBANI WRC producer Reg Kennedy is away for three weeks, collecting material for a book on religious broadcasters. He's visiting the FEBC head office in the US; HCJB, Ecuador; ELWA, Liberia; FEBA Nairobi/Seychelles; TWR, Monaco; Vatican. Meanwhile Francis Crowley produces WRC (BBC WRC 11/1)

TURKEY With VOT's cutback in EG hours comes the end of its daily DX program, which never fulfilled its great potential. Reception was awful 5/1 at 2237 on 9515, but I think they said it would be on only two times a week now (gh) Or was it three times? Anyhow, I've heard it on a Mon and on a Thu (Wilder A. Pickard II, IL)

SWEDEN Before I retire from R. Sweden next fall, I'm conducting a Jubilee Contest celebrating the 30th anniversary of SCDX. During all these years I've enjoyed the most friendly relations with colleagues from other stations in all parts of the world. To compete in the contest, therefore, participants will have to tune in to as many DX programs in EG (cont'd.)



(Knoxville Journal, 14/1, via gh)

as possible during the week Feb. 27-Mar.5 1978. It's open to every SWL in the world who understands EG; no special application is required. The winner will be the listener who has logged the greatest number of DX programmes and noted the greatest number of items in these programmes. Just send a list of headlines, no recordings, to Jubilee Contest, R. Sweden, S-105 10 Stockholm, Sweden, postmarked not later than 6th March 1978. You have to find out for yourself what DX-programmes in EG are broadcast during the contest-week, but we will mention some of them with skeds in forthcoming editions of SCDX (Arne Skoog)

SWAZILAND The TWR DX Special is no longer broadcast from this site (SCDX 10/1)

SPAIN VOS says their EG DX pgm is on Sat 2118 & 2218 on 6100/7155/9505. This corrects previous info in SCDX. A DX pgm in SP is on Sun at 2200 on 6140/7105/11920 (Barraclough, WDXC)

PORTUGAL R. Portugal noted with a DX programme Fri at 2030 on 49m (Brian Wallace, WDXC Jan)

MONACO TWR DX Special is at 1500-1515 on 7230 Sats; in EG exc first Sat in GM (S. Held (?) GFR, SCDX 10/1)

FINLAND (Cf Jan LN-13) Finn-DX now on the first & third Saturday of the month, and following Mon at 1315. There will be a competition announced on the first Saturday of each month (R. Finland 7/1 via gh) However, true to previous form, on 21/1 it started at 1313 (gh)

CANADA Help get the latest DX news out as fast as possible via my weekly reports on RCI's DX Digest on Sundays (Cf Dec LN-2 & 10 for sked details). Send your items to Glenn Hauser, address on LN-1; or if it's too late to write, you may call me (prepaid) at home (615) 522 4497, anytime but 0500-1300 GMT; or at WUOT weekdays (615) 974-5375. The script is prepared late Thu night for broadcast the following Sunday; last-minute items received by 1500 GMT Friday--my last mail delivery--can sometimes be worked in. The two editions of DX Digest are now entirely different, with Ian concentrating on answering questions in part 2. He's also resumed using the catchy old RC SW Club theme, "Honey Pot" (gh)

AUSTRALIA I understand there has been a tremendous volume of world-wide protest mail received at R. Australia, concerning the deletion of "DXers Calling". Kieth Glover said the situation was being 'reappraised' in his Club Forum program 16/12. ARDXC is still preparing DX scripts, financed, translated and broadcast by the Japanese section. It would be a nice gesture by ABC senior management to reinstitute the pgm, knowing full well that there are thousands of listeners around the world who would welcome the show back. The original reasons (not to cater for a specialized audience, and financial constraints) appear to be well and truly beaten -- how about it, RA -- why not restore things to what they were? (Bob Padula, Jan. ADRX)

PROGRAM NEWS U K O G B A N I (pronounced yew-kog-ban-EYE -gh) A few BBC WS picks for Feb: London's Musical Museums, Sats 0230, Weds 2030, Thurs 1000, Fris 1430. Gloves, Ribbons & Garters, a Valentine's Day entertainment, 13th 0945, 14th 0030, 1330. Her Majesty's Stationery Office, 22nd 1430, 23rd 0330, 24th 2030. When Nothing Else Is Left, how people face imprisonment or alien situations, Tues 0145, 0745 Weds 1115, Fris 2145. The Goon Show, Suns 1430, Tues 0330, Thurs 1030. Look Ahead, weekly program previews, Sats 1409, Suns 1640, Mons 1125. Don't Miss--Sheridan Morley's preview of March programmes, 24th 1415, 25th 2315, Feb 26th 0515, 2100 (London Calling, gh)

TANZANIA (Cf LN 1 & 10) Some R. Tanzania ES non-clang pgms: 0415-0430 Tue South African Press; Thu South African Scene; Fri Freedom Magazine. 1010-1030 Sun This Week in Africa; 1115-1200 Sat Weekend Taarab; 1310-1325 Sat The World This Week. 1615-1630 Mon South African Press; Wed South African Scene; Thu Freedom Magazine; Sat The Week in Africa. 1700-1730 Fri & Sat Spotlight on Tanzania. 1745-1800 Fri Islamic Quarter-Hour (RT via BBCMS 1/78)

POLAND I'm really surprised at how good the Polish Radio programs are, 0200 on 6095. An eastern European whose programming is not rehearsed, BS. I've heard a concise history of Poland, Bob Dylan's "Blowin' in the Wind", and, get this, wishes for a "Merry Christmas" to the listeners. Did Radio Moscow do that? (Gerry Bishop, PA, Review of Int'l Broadcasting)

NEW ZEALAND Some regular RNZ features, times valid thru Feb only. Appointment with John Gordon--music and song for the more mature tastes, Mon-Fri 0300. Roundabout, magazine of music, unusual events, interviews, at 0400. Evening Showcase, daily 0630--music, stories, plays, news, special reports (RNZ via Mac Leonhardt)

ITALY RAI BCs "Europe Radio Journal" on European Community news, M/W/F 1530-1537 on HS 2nd Pgm, carried on SW at 7175 kHz (BBCMS 12/1)

HUNGARY R. Budapest has a new feature, "The Correspondents" for Hungarian press and radio, reporting from abroad, Thu 2100, Fri 0200, 0300, 1030, 1430. Rotating features Sun 0200, 0300, 1030, 2100 & Mon 0300, 1030, 1430: Feb 5-6, Floor is Yours--has socialism solved the problem of racial minorities? Feb 12-13, Treble on a Topic--The flag, the 1848-49 & 1918-19 revolutions, and who was Bela Kun? Feb 19-20, On The House--ecosystems, literacy, the joining of Buda and Pest, the currency. Feb 26-27, Backgrounds--festivals, holidays, carnivals, weddings and gala days. (Budapest International, via gh)

GERMANY WEST DW has changed format of tiny Nam svc following critique by D. Walcutt (gh)

EGYPT Some R. Cairo musical programs in the NAM svc: Daily 0202, Egyptian Music & Song; Tue 0235 Arab Music; Wed 0235 Cairo Favorites; Fri 0235 Musical Life in Egypt; Fri 0300 Light Music; Sun 0135 (sic --gh) Variety Show. Length 10-15 mins (H. Slofstra, Dec ODXA)

CANADA Heeding some comments in Review of International Broadcasting, RCI NAM svc has begun to include a brief 'billboard' of features each night of the following week, at the conclusion of Sunday (GMT Mon) broadcasts right after DX Digest. But, they don't always come true, I've found (gh)

PUBLICATIONS

Review of International Broadcasting contains listeners' program reviews and recommendations, and continuing discussions of other topics relevant to SWling. The monthly magazine is now offset-printed (and stitched!). The rates have gone up 50%, plans are, material permitting, to publish 50% more pages per year in alternating 16 and 36 page issues (dictated by postage breaks). I assure any FRENEX readers who haven't yet seen RIB that they're really missing something! Samples are 75c in NAM or surface mail worldwide; US\$1.35 or 7 IRCs international airmail. A 12-issue subscription is US\$9.00 by first class in NAM or surface mail worldwide; US\$15.00 by international airmail. Please remit in U.S. funds payable to Glenn Hauser; address on page LN-1. A bonus for RIB subscribers is a clipping copy service of material published elsewhere related to international broadcasting; 300 individual pages are now available (gh)

World Radio-TV Handbook 1978 will be delivered during early March (January WDXC Contact) Jens Frost informs that the Handbook will be out early-mid-February, not as mentioned in some DX magazines, one month later than last year! (Finn Krone, Jan DSWCI SWN) The new edition will feature special sections on "SW Antennas" and "Portable Receivers Comparisons" (R. Australia DX 25/12) Panasonic RF-2800 digital readout portable now on US consumer market. Price maybe around \$250 list. Covers 3.2-30 MHz + MW/FM. Performance like RF-2200 & ICF-5900W, except RF-2800 is larger and heavier; covers 90m (tho not very well--has images) and has digital readout to nearest kHz. Full review in the WRTH-78 (Larry Magne, PA)

Tropical Band Survey Sep-Dec 1977, an 8-page legal-size mimeoed list from 2290 to 5095 kHz, has been published by the Union of Asian DXers, available for 5 IRCs from Victor Goonetilleke, 32/4a, Malwatta Road, Dehiwala, Sri Lanka; or for US\$2 from Larry Magne, 15 Central Ave., Rockledge, PA 19111 (gh)

ECDXA Newsletter (Cf Jan LN-14) You forgot the address. It's 3113 Waterford Dr., Cinnaminson NJ 08077 (Gerry Bishop, PA) Sorry (gh)

Down Under DX Survey No. 10/1977, 7 Donald Rd., Burwood, Vic., Australia 3125; 14-page legal size mimeoed bulletin full of original info; 3 IRCs or 50c in mint Au stamps in A&NZ; 6 IRC for rest of world, all airmail. Includes 4½ pages of double column Indonesian survey 2140-15300 kHz; Vietnam: aims and goals, article on radio development there; survey of 6200-7100 kHz; 4-page article on the Central Broadcasting System of Taiwan, etc., etc. (gh)

Far Eastern DX Review No. 16, 29/12/77, 18 x 25 cm, high quality xerox including illustrations, ¥6000 per year; sample 5 IRCs by airmail from JADX, CPO Box 1766, Tokyo 100-91 Japan. This issue features Burma background including map; flashback to 1974 Laotian broadcasting. 3 pages showing new MW channel plan of N. Korea, including geog. coordinates, and 14 stations in the 250-1500 kW range; and the usual roundup of DX news; 17 pages (gh)

Play-DX, fortnightly for active DXers, has expanded bulletin for 1978; first issue was 14 legal size somewhat messily xeroxed pages. QSL and news review, MW & SW loggings by freq; new utility page; articles on solar activity in 1978, reporting to utes, ham listening news, lists of Italy's private FM&TV stations; domestic subscription is 8000 Lire per year; contact editor Dario Monferini, via Davanzati 8, 20158 Milano, for other rates. He speaks English, but Play-DX is mostly in Italian (gh)

Herbert H. Lehman College Radio DX Club News, Nov 1977 issue is a 36-page FRENEX-size magazine, xeroxed with legibility problems around the edges. Most of the columns are edited by David S. Brodsky & Michael Maghakian: oddball "World News H! Lites!" culled from press, loggings in SPEEDX format; technical and station feature articles; QSL Reports; Station Schedules; Readers Column; Time Index; BCB section; The Last Resort Antenna That Works!!!. Ask Willie, He Knows; Utility Hunters. Holds weekly meetings at the college. No subscription info given; address: Radio DX Club, H.H. Lehman College, Bedford Park Blvd West, Bronx NY

DX World Monitor, quarterly 20-p tightly mimeoed bulletin of Radio DX Listeners' League, 2 Lady Gordon's Drive, Kandy, Sri Lanka. Rs 1.50 in S.L.; 3 IRCs airmail worldwide; 2 surface edited by Ravinda Bulathgama. Many brief articles and skeds: Europe Offshore; German language BCs, logs from E & W Germany; by-freq list of some DX programs; SLBC sked; TWR's new MW site at Puttalam, SL; R. RSA sked, RBI, RN; Penfriends; schematic of 3 transistor regenerative MW rx. 12 IRCs per year, or US/Canadian \$2.50; special rates in bulk or for libraries & schools (gh)

Broadcasting from the High Seas, 1977 book written & published by Paul Harris, Edinburgh, ISBN 0 904505 07 3; 7.50 pounds. Concentrates on British pirates 1958-1976, not just a nostalgia trip but full descriptions of stns; rivalries: legal clashes (A. Pennington, WDXC)

Broadcasting to Yugoslavia: External radio broadcasting and international understanding. UNESCO Reports and papers on mass communication No. 81, 1977. A 51-page monograph written by 6 Yugoslav scholars. ISBN 92-3-101523-0. Text is mostly in plain language, with 13 figures & 13 tables with evaluations and correlations. The methodology itself is of as much interest as the conclusions. One hopes such studies will ultimately be made about countries of greater interest. No price given. Order from Unipub, Box 433, Murray Hill Stn, New York NY 10016; or from Uganda Bookshop, Box 145, Kampala, i.a. (gh)

The Night Watch, book by David Atlee Phillips, Athenium. A former psywar expert attempts to rescue the public image of the CIA. It contains some interesting info for DXers & SWLs, while the info withheld is even more interesting. The omissions are important because they provide solid clues as to which BC operations, even some apparently no longer connected with the CIA, Phillips is trying to protect--such as WRUL's role in the Guatemalan revolution; R. Swan SW operations; R. Cuba Independiente, believed to have operated from the yacht "Matusa Time" prior to the Bay of Pigs. The explanation Phillips offers for these and many other omissions is: "Finally, Colby said, there are 'good secrets', those which protect the identities of American intelligence sources (the people and equipment producing intelligence) and methods (the manner in which men and machines obtain the information). I have used literary license where necessary to protect good secrets". But how can international broadcast stations no longer connected with the CIA have anything to do with intelligence sources? (SW News Service, Ont.)

IN MY OPINION

(Ed. Note: This was written several months ago; I circulated it immediately among NASWA Executive Council members --gh)

Roger N. Peterson, CT: FRENDX vs. SPEEDX. I wrote for a sample of SPEEDX and was very surprised to see a good, clean printing job, much better make-up and, in my opinion, far better organized issue than FRENDX. So SPEEDX got a new subscriber. Now that I have seen 3 issues there is no question that SPEEDX is a far better presentation than FRENDX--except for LN. But what good is all that info if it can't be read because of poor printing? I also like the way SPEEDX organizes their Log Sections--by continent instead of by frequency. Much easier to check on a country or station that way. NASWA is obviously much larger than SPEEDX. Income for NASWA was \$21,202 as against only \$8,930 for SPEEDX. Mailing costs for FRENDX about double that of SPEEDX. But get this--printing costs were \$8,058 for FRENDX as against only \$3,499 for SPEEDX! Twice the quantity should not cost twice as many dollars. Either SPEEDX is getting a bargain or FRENDX is being grossly overcharged for a poor printing job, month after month.

gh: I think the SWL/DX hobby is big enough for both SPEEDX and NASWA, with their different approaches and presentation; though I feel in their log sections, SPEEDX has a commitment to mediocrity in discouraging intelligent comment on program details, allegedly to keep it simple (read boring) for the benefit of SPEEDX's many members in Japan. FRENDX printing was definitely inferior, but the best we could do under the circumstances. Our new printer has promised to do a much better job, and time will tell.

Richard Larson, MN (from Jan. RIB) Why can't or won't NASWA, or better yet, ANARC, put on an ad to get people interested in SWling/DXing? Ad few months ago on WCCO-830 during the CBS Radio Mystery Theatre, urging people to become Radio Amateurs. I believe it was by the ARRI.

gh: This was very likely free public-service advertising. ANARC and NASWA would have to establish standing with the Advertising Council in order to qualify. Worth looking into.

Louis Goldstein, MA: Any indication of FRENDX improvements in format? Have not found publication up to expectations for fee charged. When they added the final straw of not publishing up to date list of members, that did it for me. A secret mailing list of members from outsiders might have merit...but to keep membership secret from members is not reasonable. Members are not even able to communicate with each other in an outfit promoting better use of worldwide communications!

gh: I detect no such motivation in Mac's announcement on Oct FRENDX-3. It is a big job. Would you be willing to volunteer to do it, if that suited Mac? However, once published, it would be difficult to keep the list from falling into the 'wrong' hands. I will be glad to publish full addresses of any LN contributors who request me to.

THE PULSER

For what we believe is the first time ever, Soviet OTH radar signals have been heard below 3 MHz, i.e. on Medium Wave; centered on 2650 kHz, at least 100 kHz wide, first logged 19/12 from 2115. Again 20/12 2011; and 22/12 at the incredible time of 1906--no MW Trans-Atlantic signal has ever been heard at SWNS HQ that early in the afternoon before (SWNS) Absolutely sure this is from USSR? (gh)

INTERNATIONAL BROADCASTERS YEAR 1978

This is the year to make an extra effort to publicize SWling in your local media, and to help out your favorite stations with program comments. ANARC will appoint an IBCY Committee; if you would like to serve on it, write anarc, Dave Browne, Executive Secretary, 557 N. Madison Ave., Pasadena CA 91101 (gh)

naswa AWARDS reports

Dan Henderson, Chairman
7921 Anfred Drive
Laurel, Maryland 20810

NOTE NEW ADDRESS!!!

February, 1978

The following report gives all awards issued during the period 1 October 1977 through 31 December 1977. All awards are listed in chronological order of issue.

AFRICAN CONTINENTAL DXPERT

Marlin Field

EUROPEAN CONTINENTAL DXER

W. Robert Viau
Frank J. Harmans
Craig Warren Child

EUROPEAN CONTINENTAL DXPERT

Marlin Field

SOUTH AMERICAN CONTINENTAL DXPERT

Marlin Field

NORTH AMERICAN CONTINENTAL DXER

D. C. McCarthy

NORTH AMERICAN CONTINENTAL DXPERT

Marlin Field

DXER DE PACIFICA

Marlin Field
Pitt McNeill

ASIAN CONTINENTAL DXER

Ira Teitelbaum

ASIAN CONTINENTAL DXPERT

Marlin Field

WORLD WIDE DXER

W. Robert Viau
Edward G. Stroh
Mark Vincent
Frank J. Hermann
Ralph Alm
Mitchell Taylor
Kevin McManus

DX CENTURION

Albert E. Cannon
D. C. McCarthy
Kent Magill
Martin Foltz

SENIOR DX CENTURION

Pitt McNeill

MASTER DX CENTURION

Marlin Field (No. 6)

ALL CONTINENT QRP

Albert E. Cannon--50 Kw
Ira Teitelbaum--50 Kw

MASTER NIGERIAN DXER

Marlin Field

SENIOR SUBCONTINENTAL DXER

Marlin Field

MASTER SOVIET SPHERE DXER

Marlin Field

ORTF DXER

Marlin Field

EMISSORA REGIONAL DXER

Marlin Field
John C. Herkimer
Bill Whitacre

ECCLESIASTIC DXER

Kevin Mikell

MAPLE LEAF DXER

Marlin Field

VOA DXER

Marlin Field

SENIOR BRAZILIAN DXER

Marlin Field(No. 2)

SENIOR ECCLESIASTIC DXER

Marlin Field(No. 2)

MASTER PAPUA NEW GUINEA DXER

Marlin Field

SENIOR TROPICAL BAND DXER

Marlin Field

Well, that's all for this quarter. Congrats to Marlin Field for the Master DX Centurion award--No. 6. Also for the Master Papua New Guinea award--No. 2. Please note the new address for the awards program, and also remember that the only stamps that will be accepted for awards payment are 4-13 cent stamps. All checks should be made out to me--not NASWA. This will speed up the award application processing. Also, an updated list of awards and requirements will be published just as soon as I can get settled in my new QTH. Till next quarter-----73.

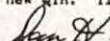

Dan Henderson
7921 Anfred Drive
Laurel, Maryland 20810

QSL REPORT



Sam Barto 245 Cherry Ave. J-11 Watertown, Conn. USA 06795

We have a very large report this month with many quality QSL's to report...so on to the business at hand!

- ALBANIA:** Radio Tirana 42mb., f/d card in 3 mo. for 1 IRC, postcards and schedule received (Stanziale).
- ALGERIA:** RTVA 6145, f/d blue "Logo and Antenna" card, sked and report forms in 75 days (Cannon).
- ANTIGUA:** DW 5960, multi-color non-QSL in 114 days (Blossom).
- ARGENTINA:** LOI 10000, card and other data in 2 mo. for 1 IRC (Hermann).
Radio Nacional Mendoza 6180, f/d view card w/ snow scene in 3 wks. for a SP report and m/s. Report was mailed to and received from
please Jose A. Sabater, Presidente-Editor, Club DX Aconcagua, Casilla 533
notel 5500 Mendoza, Argentina. (Sparks).....Its tips like these which
keep this column and NASWA tops in its field!...Sam. (Wirsz).
- ARMENIA:** Radio Yerevan 15180, small f/d card via registered mail in 105 ds.
- ASIATIC RUSSIA:** Radio Moscow via Khabarovsk on 6070 in 28 ds. (Wirsz). same site on 15100 in 39 ds. (McCarthy). via Petropavlovsk-Kamchatsky on 17720 in 42 ds. "Skyscraper with Flowers" card (McCarthy). same and also on 15450 in @ 1 mo (Hermann).
- AUSTRALIA:** Radio Australia 15160 via Lyndhurst f/d "Fringe Lily" card in 105 ds. v/s Koch, Director Overseas Service (Desrosiers). same in 6 mo. (Lobdell). same site for 5995 in 19 ds. for 1 IRC (Burns).
via Shepparton on 17715, 15205 w/ "Scarlet Crested Parakeet" card in 105 ds. and w/ "White Flowering Mallee Gum" card for same site on 15320 and 15140 in 105 ds. (Desrosiers). same site on 9580 in 24 ds. for 1 IRC. (Sandborn). same site w/ "Parakeet" card in 144 ds. (Brooker)...no site reported...15320 "Fringe Lily" card in 98 ds. (Wirsz). 9580 "Parakeet" card in 5 mo. (Miller).
VNG 12000, f/d folder and station info. in 46 ds. (Brooker).
- AUSTRIA:** ORF 9770 "Lovers" & "Glass Towers" cards in 59 and 113 ds. (Wirsz).
f/d "ORF Centre with SW Studios" card in 55 ds. for 9770. (Baum).
same freq. in 2 mo. w/ "Austrian Art" card, sked and forms (Miller).
- BELGIUM:** ORU 6080, f/d card in 68 ds. for 1 IRC. Also received sticker, sked and pennant (Baum). same in 59 ds. for 1 IRC (Sandborn). in 54 ds. w/ tourist brochure (Golkin). same freq. in 21 wks. (Stanziale).
"Globe" card for 9725 in 4 wks. for an SASE (Miller). "Modulateur" card for 21460 in 3 wks. (Barto).
- BENIN:** La Voix du Revolution 4870, f/d card in 6 mo. for EG report and 1 IRC. (M. Smith).
- BOLIVIA:** Radio Panamerica 6035, letter and small pennant in 27 wks. for an SP report and m/s. v/s Luis Penaranda Beltran, Sub. Dir. (Sparks).
- BONAIRE:** Radio Nederland 17810, "Authentic Costumes" card in 3 wks. (Barto).
"Station Staff" card for 9715 and 6165 in 2 wks. (Barto).

BRITISH HONDURAS BROADCASTING SERVICE



SUPPORT NASWA
"Friendship and Unity"

Servicio Radiodifusor de Honduras Britanica

BONAIRE: Radio Nederland 6165, f/d
"Staff" card in 2 wks. (Burns)
Trans World Radio 11925, f/d
card in 20 ds. for 2 IRC's.
Station sent religious info,
calendar and an Antilles
penny (Baum). "Island of Flam-
ingoes" card in 2 wks. (Miller).

BOUGANVILLE: Radio North Solomons 3322,
very nice letter in 3 1/2 wks.
v/s Aloysius Rumina, Acting
Station Manager. (Barto).

BRASIL: Rdf. do Amazonas 4807, post-
card in 30 ds. for a PT report.
v/s Jose Joaquin Marinho. Addr:
C.P. 311, Manaus. The v/s is a
stamp collector so take note!
(Hoogerheide).

Radio Cultural do Para 5045,
card in 60 ds. for a PT rpt.
(Hoogerheide).
Radio Educadora Sao Jose Ltda.
2400, f/d letter in 3 wks. from
Father Jorge Basile - PIME,
Orientador. Station enclosed
stamps. This was my SWBC QSL
5000. (Barto).

BULGARIA: Radio Sofia 7115, f/d card and
letter in 30 ds. for 1 IRC.

Also received sked and re-
port forms (Burns). 9700 card
in 4 mo. (Hermann). 7115 "Sofia Univ." card in 2 mo. (Miller).

BYELORUSSIA: Radio Moscow via Orsha on 7100 "Woods Scene" card in 34 ds.
(Hoffman). same in 1 mo. (Barto). same in 41 ds. with "Winter
in Moscow" card. (Yacono).

CAMEROON: Radio Yaounde 4972.5, f/d card in 78 ds. for 1 IRC (M. Smith).
CANADA: BBC via Sackville 9510, card in 45 ds. (Wirsz). CKOB 4200 (3x1400),
letter from Martin Burns, G.M. (Barto). CHU 7335, card in 5(1) ds.
(Berezowski). CBC-NS 11720, "Horizon Suns" card in 1 mo. (Marshall)
CFRX 6070, "Boat" card in 14 ds. (Wirsz).

CHILE: Radio Universidad de Concepcion 6135, EG letter, card, small penn-
ant and stamps for an EG report and m/s in 23 ds. Letter stated
that no rp. is needed. v/s Carlos Godoy Rocca, Director. (Sparks).

CHINA, PEOPLES REP: Radio Peking 15060, 15520. "Pagoda" card in 24 ds. (Burke)
7120 "Lumber" card, sked in 3 wks. (Miller). 15060 in 16 ds. Also
received pennant, magazines, etc. (McCarthy). 9780 in 22 ds. (Stan-
-

COLOMBIA: Ondas del Orterguaza 4975, letter, pennant (large rect-
angular shape) and a decal in 22 wks. for a SP report and m/s.
v/s Elizabeth Santos D., Jefe de Relaciones Publicas. (Sparks).
Radio Nacional de Colombia 9655, 13850 and 11793. "Museo del Oro"
cards in 2 mo. v/s Juan Climaco Arbelaez, Director de la Radio.
(Barto). Radio Vision 12210 and 6105, "La Veracruz Church" card
in 1 mo. for a SP report. v/s Maria Eilena Vasquez U., (Barto).
Radio Sutatenza 5095, folder card w/ station
info. in 190 ds. for a SP report. (Riordan).
same in 167 ds. for an EG/SP report and 1 IRC.

v/s Isabel Salcedo (Weber). Radio Guatapuri
4815, letter in 19 ds. for an SP report and m/s.
pennant v/s Alex Quintero. Station enclosed a 6x17"
hounds! red, white and blue pennant! (Hoffman).

CUBA: Radio Habana 11930, f/d orange and purple card
in 3 mo. (Miller). same in 3 mo. (Lobdell).
CYPRUS: CBC 6150, f/d card in 38 ds. for 1 IRC. (Hoff-
CZECHOSLOVAKIA: Radio Praha 7345, f/d card in 119
man).
ds. (Wirsz). same in 124 ds. for 1 IRC (Sandborn).
7345 "Castle" card, sked and DX Club info. in
15 wks. (Miller).

TRANS WORLD RADIO

QSL



BONAIRE, NETHERLANDS ANTILLES



- CZECHOSLOVAKIA: Radio Praha 5930, "Thermia Palace" card in 116 ds. (Desrosiers). 11990 f/d card in 4 mo. (Bohlke). same freq. in 118 ds. Also received booklets, club info, skeds, etc. (Golkin).
- DENMARK: Radio Denmark 15165, f/d "Antenna" card in 5 wks. (Barto). same card in 32 ds. (Berezowski). same in 2 wks. (Miller).
- DJIBOUTI: Radio TV Djibouti 4780, card in 4 mo. for a PR report. Addr: B.P. 97, Rep. du Djibouti
- DOMINICAN REP: Radio Mil 4930, f/d letter in 18 ds. for a SP report. Call is HIBIE (Cannon). same in 27 ds. v/s Julio Castillo Jimenez (Hoffman). La Voz de las Fuerzas Armadas 4825, letter, card and pennant in 2 mo. for a Gilfer form and 1 IRC. (Riordan).
- ECUADOR: HCJB 6075, "Power Plant" card in 3 wks. (Barto). 11955 "Diesel Generator" card in 5 wks. (Barto). same for 9715 in 3 wks. (Barto). 9745 "Transmitter" card w/ DX info. in 3 wks. (Miller).
- EGYPT: Radio Cairo 9475, f/d card in 112 ds. This was my 50th SWBC Country! (Desrosiers)... Keep it up. 7120 "Palms and Pyramids" card in 106 ds. for 1 IRC. (Burns). (Miller).
- ENGLAND: VOA Woofferton 9760, f/d card in 21 ds. (Weber). 6040 in 6 ds.
- EUROPEAN RUSSIA: Radio Moscow via Moscow on 15460 for the Af. Svc., via Kenga on 9760, Tula on 7190, Armavir on 7200 and via Moscow on 9680 and on 7440. cards in @ 1 mo. (Barto). via Moscow on 7390 in 39 ds. (McCarthy). via Tula on 7250 and on 15490 (Wirsz). via Bulgarian site on 7150 in 7 wks. (Miller). cards in @ 1 mo. for Ryazan on 15140, Voronej on 12060, Tula on 7190 and Moscow on 7440. (Hermann)... For those who have not seen Roger Legge's USSR newsletter, write to him at Box 232, McLean, VA. 22101 w/ SASE.
- GERMANY, FEDERAL REP: Deutsche Welle 9590, card and pennant in 44 ds. (Marshall). "Bullseye" card for 5960 in 2 1/2 mo. (Dawson). 6010 card in 8 1/2 mo. for 1 IRC. (Onken). same w/ engineering book in 153 ds. (Golkin). Radio Free Europe 15115 card in 52 ds. (Wirsz), card in 9 ds. for 7255 and 7145 and for 17805, 17835, 15255, 15355 and 9705 in 2 wks. (Barto). Radio Liberty 17895, 17760 and 17750. cards in 2 wks. (Barto). Sudwestfunk 7265, "Ear" card in 60 ds. for an EG report (Cannon)... How does one get the sites for RFE?
- FINLAND: Radio Finland 15105, "Finnish Flag" card in 2 wks. (Miller). same in 32 ds. for a Gilfer report form (Berezowski).
- FRANCE: Radio France International 17720, f/d card in 6 wks. and sked. (Seltz). 15210 "Couleurs" card in 3 mo. for 1 IRC. Station sent me their full series of QSL cards, bumper stickers, etc. (Dawson). Got an extra one?... Sam. 15155 "La Basilique" card in 3 mo. (Lobdell). 17800 "Chambord Chateau" card in 100 ds. for 1 IRC. (Weber)
- FRENCH GUYANA: French Region Trois 3385, card in 20 ds. for 1 IRC. (Hoffman).
- GALAPAGOS: La Voz de Galapagos 4810, "Local Birds" card in 67 ds. for an EG/SP report and 1 IRC. v/s Feliz Navidad (McCarthy). same card in 2 1/2 mo. for SP report and 1 IRC. (Cannon).
- GERMAN DEM. REP: Radio Berlin International 9730, "Altes Museum" card in 53 ds. (Golkin).
- GREECE: Voice of Greece 15345 and 17830, card in 2 wks. v/s E. Styliana, Director of Technical Ser. (Barto). 11730 f/d card and sked in 4 wks. for a Gilfer form (Berekowski). same in 16 ds. card, sked and (Marshall).
- GUAM: KTWR Trans World Radio 9640, f/d decal in 19 ds. for m/s. (Sparks).
- GUATEMALA: Radio Cultural 3300, f/d card in 23 ds. along with tourist info., sked for 1 IRC. (Onken). same in 1 mo. for a postcards and 1 IRC. Gilfer form (Riordan).
- HAITI: 4VEH 9770, f/d card in 139 ds. for 1 IRC. v/s Edna Beachy, QSL Sec. (Burns)

Your Editor has QSL Column report forms available for a .13¢ SASE. They make my life so much easier.

- HAITI:** 4VEH 9770, f/d "Control" card in 129 ds. for 1 IRC. Also received sked and religious info. (Sandborn). same in 146 ds. for 1 IRC. v/s Loretta Vittoria, QSL Secretary. (Hoffman).
- HAWAII:** WWVH 15000 "Aloha" card in 14 ds. (Wirsz).
- HUNGARY:** Radio Budapest 6000, f/d card in 9 wks. for 1 IRC. (Stanziale). 15220 "Pointed Dome" card in 14 wks. (Miller). 6080 f/d card in 5 wks. (Barto)

VERIFICATION CARD

OLDIE
BUT
A
GOODIE!

RADIO LUMIÈRE

Le Poste Culturel Haïtien
Aux Cayes, Haïti

Station of the West Indies Mission, Inc.

- INDONESIA:** (IRIAN JAYA): RRI Sorong 4875, f/d card in 8 mo. for an EG report and 1 IRC. (M. Smith). (SULAWESI): RRI Palu 3960, EG letter and used Indonesian stamps in 22 ds. for an IN report and m/s. v/s Eddy Mamangkey, Kepala Studios (Sparks).
- IRAN:** NIRT 15084, f/d "Mahabad Television" card and sked in 41 ds. for 1 IRC. (Onken). same w/ "Zahedan TV" card in 51 ds. (Wirsz). 9022 f/d card in 7 wks. for 1 IRC. (Stanziale).
- ISREAL:** IBA 9815 and 11655 f/d "Western Wall" card in 3 mo. for IBA report Form (Golkin). 11655 card and forms in 10 wks. (Miller).
- ITALY:** RAI 11810, "La Partenza di Tabiolo" card in 3 mo. for 1 IRC. (Dawson). same freq. w/ "L'Aurora" card in 15 wks. for 1 IRC. (Stanziale). "Bambino" card in 56 ds. (Wirsz). "Il Pescatore" card in 5 mo. w/ sked (Miller). 9575 "Bambino" card in 96 ds. (Baum). "Statue" card in 165 ds. sked and booklets also received (Golkin). same in 177 ds. (Weber). 6010 "Vaprio sull'Adda" card in 6 wks. (Seitz). 9710 same card in 45 ds. for 1 IRC. (Fraser).
- JAPAN:** Radio Japan 15270 and 15105 "Fireworks at Lake Ashlnoko" card in 1 mo. (Barto). 11705 same card in 20 ds. (Marshall). 5990 same card in 16 ds. along with newsletter, sked and report forms (Burns). 15270 "Hakata Dolls" card, sked in 3 wks. (Miller). (Wirsz). NSB 9595 f/d "Tokyo Forum Get Together" card in 78 ds. for 1 IRC.
- JORDAN:** Hashemite Broadcasting Service 7155, f/d card in 84 ds. for an EG report and 1 IRC. Card was "The Palestine Archaeological Museum" in Jerusalem. (Hoffman). 9530 f/d "Al Aqsa Mosque" card in 2 mo.
- KOREA, DEMOCRATIC PEOPLES REP:** Radio Pvyongvang 11535, f/d "Revolutionary Opera" card, sked, pin, postcards and a zoo booklet in 57 ds. for 1 IRC. (Onken). 9977 f/d card in 2 mo. flag, badge and postcards were also received (Sillings). 9420 same card in 152 ds. along with all of the above enclosures (Weber).
- KOREAN REP:** Radio Korea 9720, card, sked and report forms received after 4th try. On the 5th time I had the report hand delivered! (Verneti) Rita... Yes I would appreciate receiving a postcard from Kwajalein.
- KUWAIT:** Radio Kuwait 12085 f/d folder card in 79 ds. (Sandborn). same in 77 ds. (Wirsz). 9555 f/d card and sked in 2 mo. (Miller).
- LATVIA:** Radio Moscow via Riga on 12020 f/d card in 5 mo. for a SP report and a cassette tape on their LA service (Cannon).
- LIBERIA:** ELWA 4770, f/d card, sked in 290 ds. for 1 IRC. (Stauner). (Wirsz). VOA Monrovia 6035 f/d card in 13 ds. (Burke). 12010 card in 41 ds.
- LIBYA:** PRB 6185, veri letter and sked in 15 ds. for an EG report and 1 IRC. I gave up all hope on this one! (M. Smith).... Never give up hope on any station. Persistence and perseverance will pay off... with a little bit of patience.

Emisora de Radiodifusión de Santa Isabel

E A J 205

Con Q. T. II, en la ciudad de Santa Isabel, capital de Guinea Ecuatorial en la Isla de Fernando Poo, Apartado de Correos n.º 191; acusa recibo de su carta en la que nos daba control de nuestras emisiones, oídas por Vd. con fecha 15-9-65 a las 22,10 horas G. M. T. Efectivamente las señales que Vd. indica, procedían de esta Estación.

Esta Emisora de Santa Isabel, le agradece mucho su información y le invita a oír sus emisiones con regularidad. Le adjuntamos un horario de las mismas, y aprovechamos la ocasión para suscribirnos de Vd. afectísimo, seguro servidor que estrecha su mano.

El Director

Joe, I'll trade you 50 Soviet sites for this one.....Sam.

LITHUANIA: Radio Vilnius 9610, "Town Art" card in 16 wks. (Miller). 15405 f/d "Tree and Bird" card in 4 mo. for 1 IRC. Schedule and station pennant also received. (Dawson).

MALAGASY: Radio Netherlands 15385, "Staff" card in 6 wks. 11730 "Windmill" card in 2 wks. 11730 "Staff" card in 3 wks (Barto). 11740 "Staff" card in 3 mo. and other requested materials (Stanziale). 15380 "Wooden Antenna Towers" card in 1 mo. (Lobdell) 15385 "Staff" card in 22 ds (Weber).

MALAYSIA: Radio Malaysia 4845, folder card, travel info., and stamps in 27 ds. for 1 IRC. (M. Smith).

MALAWI: Malawi Broadcasting Corp. 3380, two f/d blue form letters w/ sked in 9 mo. and in 4 mo. for 2 IRC's. v/s M.J.F. Chapuma (Cannon).

MEXICO: Radio Huayacocotla 2390, postcard in 25 ds. for a SP report and m/s. v/s

take note! Jorge V. Villalobos. Addr: Sistema Educativo Radiofonico de Mexico A.C., Zaragoza # 78, Coyocaoan, Mexico 21, D.F. Station uses 500 watts. (Dileo). card in 30 ds. for a SP report mailed to their Mexico City address. (Hoogerheide)...Nice catch! Trans World Radio 7105, f/d card in 58 ds. for 1 IRC. (Sandborn).

MONACO: Deutsche Welle 11960 f/d prepared card in 31 ds. for 2 IRC's. v/s H. Berghaeuser, Station Engineer (Young).

NETHERLANDS: Radio Netherlands 9715, "Staff" card in 6 wks. (Miller). 9895 & 15220 f/d "Windmill" card in 2 wks. from the Lopik site (Barto). 11730 Lopik f/d "Authentic Costumes" card in 3 wks. (Barto). 11730 "Staff" card in 17 ds. (Marshall).

NEW ZEALAND: Radio New Zealand 11705, f/d card and pennant in 2 wks. for no rp (Russell)...I usually do not print 'no rp' if none was used; however, in the case of RNZ, I thought it was a requirement.

NIGERIA: NBC Jos 5965, letter in 4 mo. v/s Mohammed, Senior Engineer. (Sparks). Voice of Nigeria Ikorodu 7275, f/d "Flag" card in 39 ds. for 1 IRC. (Blossom). NBC Sogunle 4990, two verie letters for two receptions (Cannon).



RADIO VILA

QSL cards; One from Radio Vila and the other from Radio New Caledonia. Both are from the South Pacific and their design is somewhat similar.

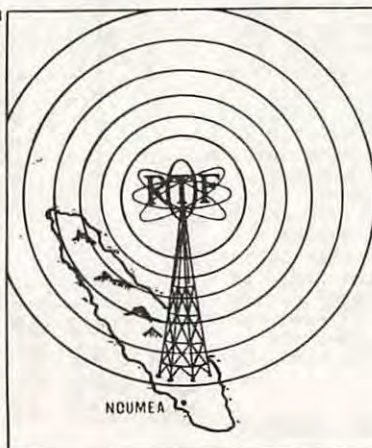

Nouvelle Calédonie

Position géographique
22° 18' 04" SUD
166° 29' 02" EST

FREQUENCES

Longueurs d'ondes d'émissions

670 Kh 448 m 20 KW
3355 Kh 90 m 20 KW
7170 Kh 42 m 20 KW

11710 Kh 25m 4KW

SUPPORT NASWA
The fastest growing DX bulletin in North America.

- NORWAY:** Radio Norway 9645, card and sked in 16 wks.(Miller).15175 f/d card and sked in 26 ds.(Berezowski). same in 16 ds. for 1 IRC.(Weber). 21730(LLQ) and 15175(LLM) cards in 1 mo. (Barto).
- PAPUA NEW GUINEA:** Radio North Solomons 3322, (sorry...should be listed as Bouganville), letter in 58 ds. for 1 IRC(M. Smith). same f/d letter in 56 ds. for 1 IRC. v/s Aloysius Sahoto, Station Manager.(Hoffman) Radio Central District 3290, f/d "Map" card, schedule and pennant in 20 ds.(Cannon). card and a small paper pennant along with a picture postcard in 18 ds. for m/s.(Sparks). NBC 4890 Fort Moresby f/d "Map" card and pennant in 40 ds. for 1 IRC.(Brooker).
- PHILIPPINES:** FEBC 17810, no QSL card but received a letter by Zeny Visca containg religious materials and a questionnaire in 93 ds. for 3 IRC's. This was my second report. Wrong Box # in WRTVH.(Onken).
- POLAND:** Polskie Radio 6135, f/d "Coat of Arms" card with sked in 12 wks.(Miller). 7270 same f/d card in 55 ds., pin also received(Sandborn)
- PORTUGAL:** Radio Portugal 11935, f/d card in 1 mo.(Stanziale)."Calvelhe Stream" card w/ sked for 11935(Miller). Vox Fidei via Sines 9670, f/d "Gustav Dore" card in GM in 16 ds. for 1 IRC.(Brooker).
- ROMANIA:** Radio Bucharest 11755 "Folk Art" card, sked, and DX Club info. sheet in 91 ds.(Miller). 5990 "Sculpture" card in 30 ds. Station sent along a brochure, sked and some beautiful stamps.(Seitz).
- RWANDA:** Deutsche Welle 17800, card in 3 mo. (Barto).
- SARAWAK:** Radio Malaysia Sarawak 4950 Kuching, f/d "Broadcast House" card in 16 ds. for 1 IRC.(Wirsz).
- SEYCHELLES:** FEBA, white, black and yellow card in 31 ds.(Gercken). 11800 f/d card in 29 ds. for 2 IRC's. v/s Liz Scott, QSL Secretary. (Burke).
- SOUTH AFRICA:** Radio RSA 9585, "Southern Africa Sunset" card in 21 ds. for 1 IRC. (Ventura). same f/d card and freq. in 6 wks.(Stanziale).9585 "Giraffe" card and magazine in 2 wks.(McCarthy).11900 "Sunset" card in 26 ds. for 1 IRC.(Weber).same card and freq. in 31 ds. for 1 IRC.(Fraser). 9585, 11800 and 11900 "Sunset" card in 2 mo. (Barto).11900 same card w/ pennant in 25 ds.(Baum).11900 "Johannesburg at Night" card in 43 ds.(Miller). Springbok Radio 4810, card in 1½ mo. Also received a South African penny, sked and fact sheet.(Sillings). 4810, card and pennant in 24 ds. (Hermann). SABC 4880, f/d card in 3 wks. (Barto).
- SPAIN:** RTVE 9360, 9630 and 11775 3 different f/d "Antenna" cards in 37 ds. using their report forms(Wirsz). 11880 f/d card, sked in 32 ds. (Miller)...Was this the Canary Islands Relay?...Sam.6065, f/d card in 21 ds. Also received an XMAS card and sked.(Fraser).
- SWAZILAND:** Trans World Radio 11955, f/d "Antenna / Warrior" card in 22 ds. for 1 IRC. (Onken). same card in 1 mo. for 2 IRC's.(Hermann).
- SWEDEN:** Radio Sweden 15305 Horby, f/d "Map" card in 29 ds. v/s Ada Fung. (Burke). 15305 f/d "Northern Lights" card. v/s Anette Beijer. (Burns).same card and freq. in 1 mo.(Miller).21690 Horby 2, f/d card in 2 wks.(Barto).same card and freq. in 18 ds.(Swanson). 9630, 11915 and 11780 cards in 5 wks.(Barto).



Radio Del Pacifico

LIMA
PERU

Your Editor has report forms for use in the QSL column. I would appreciate your using them. Send a .13¢ SASE for copies.

AM	OAZ	4K	640	KHZ
FM	OAZ	4X	102	MHZ
OC	OAZ	4L	9675	KHZ
OC	OCX	4H	4975	KHZ

SUPPORT YOUR COLUMN AND YOUR BULLETIN

SWEDEN: Radio Sweden
17770 Horby 1,
21690 Horby 2,
9745, 15305
Karlsborg and
21590 Varberg
site for USB,
cards in 3 wks.
(Barto).

SWITZERLAND: SBC 15140,
card in 11 wks..
(Miller).
Red Cross Radio
7210, card in
49 ds. (Golkin).

TAHITI: French Region
Trois, 11825, f/d card, sked in 36 ds. for 1 IRC. (Blossom). 15170, f/d card "Nudie Cutie" in 71 ds. for a French report and 1 IRC.

TAIWAN: Central Broadcasting System 11905, f/d large blue card in (Burns). 24 ds. v/s Chen mel-sheng. Station sent along postcards, sked and a letter requesting more reports. (Hoffman). Voice of Free China 17890 f/d "Snow Geese" card in 50 ds. (Wirsz). 15425 "Birds and Rich Grain" card with a sked in 2 wks. (Miller).

TOGO: Radio Togo 5047 Lome, f/d "Map" card in 46 ds. for an EG/FR report and 1 IRC. (Desrosiers). same card in 6 wks. for a FR report and 1 IRC. (Bohlke).

TUNISIA: RTVT 7275 Sfax, f/d "Les Oasis" card in 3 wks. (Barto).

TURKEY: Voice of Turkey 9515, "Native Costume" card in 88 ds. for 1 IRC. Pennant and sked also received. (Fraser). 9515 "Matbaasi" card in 18 ds. for 1 IRC. All types of tourist info. and pennant received. (Weber). 9515 "Tapestry" card w/ sked in 29 ds. for 1 IRC. (Ventura). same freq. but "Mosque" card in 28 ds. along w/ same stuff as above. (Burns). 11880 same card w/ pennant in 11 wks. (Miller).

TURKMEN: Radio Moscow via Ashkhabad on 11930, f/d card in 5 mo. for a SP report and a cassette tape on their LA Service. (Cannon).

UGANDA: Uganda Broadcasting Corp. 15325, form letter w/ no data in 47 ds. for an EG report and 1 IRC. (M. Smith).

UKRAINE: Radio Moscow via Vinnitsa on 5940, card in 1 mo. (Hermann). same in @ 1 mo. (Barto). Via Starobelsk on 7175, Simferopol on 7135, Kiev on 7165 and via Lvov on 7100 all f/d cards in 28 ds. (Wirsz). Via Lvov on 6070 and 6120 and via Ivano-Frankovsk on 7110. cards in 1 mo. (Barto). Via Kiev on 12030, card in 5 wks. (Barto). Via Simferopol on 7130 in 39 ds. (McCarthy). Via Lvov on 7210 and on 6120. cards in 1 mo. (Hermann). Via Ivano-Frankovsk on 7110 in 1 mo. (Hermann). Radio Kiev on 7390, f/d card and sked in 77 ds. (Miller).



BLUEFIELDS Ap. 72 NICARAGUA Tel. 54

ZYJ=465  **580 KHZ**
4905

RÁDIO RELÓGIO FEDERAL LTDA.

WE HEREBY ASCERTAIN THAT :
CONFIRMAMOS QUE :

Sam Barto
245 Cherry Ave. J-11
Watertown, Ct.
06795



AV. PRESIDENTE
VARGAS, 417-A
18º ANDAR
RIO DE JANEIRO-RJ
ZC 00- CEP 20.000
BRASIL

USA

HAS HEARD OUR RADIO STATION :
OUVIU NOSSA EMISSORA : 28/11/77

USA: WYFR 6155, f/d card in 18 ds. (Burns). 15110 from Okeechobee, FL. f/d card in 2 wks. for .26¢. (Hoffman). 6155, Scituate, card in 17 ds. for 1 IRC. (Hermann). 15110 "Mike" card, sked in 2 wks. (Miller). 15440 card in 2½ wks. (Stan-ziale). United Nations Radio 6055, blue and white card in 7 mo. (Sillings). WINB 11730, f/d card in 5 mo. v/s John Norris, VP. (Lobdell). KGEI 5980, "San Francisco" card in 12 ds. (Miller). AFRTS 15330, card in 12 ds. (Miller). VOA Dixon card in 7 ds. (McCants).

USSR: Radio Moscow 7170, card and pennant in 21 ds. (Baum). 9810 and 15455 card in 1 mo. (Barto).

UZBEK: Radio Tashkent 11730, f/d blue card, postcards, sked in 46 ds. (Brooker). 9600 f/d card in 34 ds. (Fraser). 9600 "Statue of Lenin" card in 7 wks. (Miller).

VENEZUELA: Radio Lara 4800, letter in 60 ds. for 1 IRC. (Riordan). Radio Juventud 4900, "Dancers" card in 28 ds. for a SP report and 1 IRC. (Burns). La Voz de El Tigre 3255, letter in 22 ds. for a SP report and m/s. v/s Graciela Cedeno. Large pennant was also received. (Hoffman). Radio Nacional de Venezuela 15400, f/d "Corocoras" card and sked in 60 ds. v/s Charlie Nash. 1 IRC. (Onken).

YUGOSLAVIA: Radio Belgrade 9620, f/d folder card in 79 ds. after a follow up. The station sent a personal letter in which they regretted that none of my previous reports reached the station. My other report was sent to the Yugoslavian Embassy in D.C. (Hoffman).

ZAIRE: La Voix du Zaire 15245 Kinshasa, letter in 32 ds. for a PR report and 1 IRC. v/s Yembi Nsampala and Lumembo Alinga. (Hoffman). letter and sked in 254 ds. for a PR report. v/s Edope Mondengela (Brooker). 15350 and 15245, 2 f/d letters in 2 mo. for a PR report. v/s N'Siala-Mavambu Mbwetete, Le Directeur de L'Exploitation des Telecommunications. (Barto).

check
out
the
v/s!

This month we had 93 countries reported. Let's get at least 7 more for the March issue. Next month we will spotlight some African QSL's. Get your copies in for filler material.... Sam.

"FRO / FRC HOLLAND" - P.O. BOX 9460 - THE HAGUE - HOLLAND.

Tune in & TURN ON



RNI

Radio NorthSea International

Good QSL
hunting
till next
issue.

Sam

I LISTEN TO
World Music Radio

transmitted by RADIO ANDORRA INTERNATIONAL

No. ONE
IN EUROPE

ON SHORT WAVE 49 METRES



LA VOZ DE BOGOTA
890 KHZ.

update

February 1978 Number 12

Tom Alleman
615 W. 43rd Terr., Apt. 6
Kansas City, MO 64111
(816) 931-5943 0030-0430 GMT

UPCOMING DEADLINES: 10 February (Mid-Feb); 20 February (March); 10 March (Mid-March)

Reprinting permitted provided due credit is given the original reporter and NASWA UPDATE. BBC Monitoring Service (BBCMS) items are copyrighted and may not be reproduced without their permission. Dates, times, and days are GMT; freqs are kHz. UADX denotes Union of Asian DXers Bulletin.

CONTEST REMINDER: Still time to get details on the 1978 Tropical Bands Monitoring and Contest event, which is described more fully in the January UPDATE. Write Mr. James W. Young, Post Office Box 576, Wrightwood, California 92397 USA.

- AUSTRIA** ORF, 15275 NF, noted 1230-1255 in EG to Nam. // 6155, 9770, and 17710. S/on is probably 1200. (Bob Zilmer, WISC) *** Welcome aboard, OM. TBA
- BRAZIL** R. Educadora Rural, Coari, 2490, TENTATIVELY noted 25 December from 0950-1008 w/ W in PT between bars of "Silent Night". Possible nx by W after 1000. Weak but readable. Also noted 13 January at *1000 w/ clear PT signals. Joe DiLeo, monitoring the same stn, heard a TC for GMT-4 which fits with general area of Coari. Joe also believes that he heard Coari mentioned. Listed in WRVH as 250 w. (Sam Barto, CONN) *** Welcome, Sam. See Glenn Hauser's report on this in Mid-Jan for more details. tba *** R. Poti, 4965, in PT at 2200 w/ ID and "A Voz do Brazil" px. Afterwards, into pop mx. QRM from Santa Fé after 2320. (Gerry Bishop, PA) +++ R. Cultura, 5015, in PT at 0230 w/ MoR mx, anncr and occasional IDs and ads. UTE QRM. (Bishop, PA) +++ R. Diario da Manha, 9675, at 2300 in PT w/ local arrangements of US and UK pop mx. Had one very good recording of "Honky Tonk Women". (Bishop, PA; emphasis in original.) +++ Ceara Radio Clube, 15167, in PT at 1940 w/ px of MoR Brazilian mx, frequent IDs and several TCs. Only 19m Brazilian heard at this time. (Bishop, PA) +++ DX Party line has picked up the story [reported in Jan LN-11. tba] that all privately owned Brazilian SW stns will soon leave the air. Would seem at first glance to cover many stns, but exact impact is unknown at this point. Seems clear that the move will have a large effect on the tropical bands. (Neal Perdue, ALA) *** See also RIB 11, p. 3. No one seems to know what will happen with the Brazilians. Shake-ups like this usually reflect someone's fear that private owned broadcasters are a threat to the existing government. An old but oft-repeated story I fear. (tba)
- CAPE VERDE IS.** R. Barlavento, 3920v, TENTATIVELY noted at 0735 w/ PT pop mx, popping through the AROs now and then. Don't know what else it could be. The freq tended to move up to 3923a, but never up to where it belonged. Measured against 3985 and time sig on 3810. 3930 was clear of QRM. (Bishop, PA) *** Interesting report. Can anyone else help ID this once and for all? tba
- COLOMBIA** Ecos del Combeima, back on 4785, in SP, primarily featuring px from the Super network. Many Super IDs, but also heard EdC IDs to be sure of ID. (Pitt McNeil, DC) *** this clears up any confusion about the two Colombians reported on this freq last time. tba *** R. Bucaramanga, 4845, 0330-0400* on 13 January. Nice latin mx w. EG and SP anncmts on the beauty of Colombia; e.g., "Come visit beautiful Colombia . . .". Full SP ID at 0355. Also mentioned R. Continental. Weak w/ some QRM. (Chuck Hafter, N.CAR.)
- ECUADOR** R. Rio Amazonas, 4870, in Indian at *1134 w/ anthem, high-pitched singing and chanting in Indian lang. (Jack Jones, MISS)
- EGYPT** Cairo, 9620 NF, at 0447 // 7075. VOA also noted in AR on this freq at 2023 w/ loud sigs. UAE watchers beware. (McNeil, DC)
- GERMANY (FED. REP.)** Sueddeutscher Rundfunk, 6030, in GM at 0630 w/ px of popular MoR tunes, weather report, ID and an occasional comm. AFRTS QRM, as usual. (Bishop, PA)
- GUINEA** Conakry, drifting between 15307-15310, at 2200-2337. Fine level. Mx, 2200-2230; FR talks and comment, 2233-2252; more mx, 2300-2330; nx of Senegal 2330-2337. (Randy Doyle, ARK)
- HONDURAS** R. Juticalpa, 4780, in SP at *1201 w/ ID ("Esta es R. Juticalpa . . ."), call and freq. Then into "Musica tropical." (Jones, MISS)
- IRAN** Tehran has now added 15260 // 15084 during its morning transmissions. Schedule remains as before. (Zilmer, WISC)
- IRAQ** Baghdad, 9745, now using the following schedule: *1930-2029* in FR; *2030-2130* in GM; *2130-2230* in EG, w/ nx, "Oriental Mx" (their description), comment, feature on the cultural scene w/ stories on Iraqi museums, artists and authors. Missed part of the EG tx for dinner. (Ed Ricchezza, PA) *** We all have priorities, Ed. Hi. tba

ISRAEL IBA usually uses alternate freqs of 9740 and 11960 during its 2000-2030 EG tx, // 9425, 9009, 7412, and 5900. (Zilmer, WISC)

ITALY RAI, 5990, in EG at 0100 w/ nx by the hilarious female announcer and IT light mx. Moved from 6010; poor decision. (Bill McMullen, MICH). *** Touché. tba

LEBANON Beirut, 5980, in AR w/ local songs 0447-0500, then gong, ID, and AR nx. Noted on a Monday when loud 5985 was off. (McNeil, DC)

MEXICO R. Huayacocotla, 2390, in SP at 0034 w/ usual fare of IDs, Mexican mx, occasional nx px, and TCs. Not strong; had to dig for them. (Bishop, PA)

MOZAMBIQUE RM, 4865, heard to s/on at 0255 rather than as listed in WRTVH. IDs in EG, FR, and PT before s/on. Good level, but some het. (Gerald Word, GA)

NEPAL Lucked on to RN, 3425 at 0030; subont mx, hosted by M; ID and short talk at 0050, then back to mx till 0120, when ID was given. Nx followed. Still audible at 0125 tone out. Px was in apparent Nepalese. (Bishop, PA)

NIGER ORTN, 5020, in FR at 0530 10 January w/ chants and idle talk by announcer. Good level. 3280, also used by them, not heard at this time, but has been in the past. (Bishop, PA)

NIGERIA RN-Kaduna, 3396, at 2140 w/ local px of area mx, and into national relay at 2200 after IS and ID. (Bishop, PA)

PERU R. El Sol, 5970, in SP at 1029. "B. Dias Hermanos de Peru, H'mnos de America y H'mnos del mundo . . ." Then Peruvian mx. (Jones, MISS) +++ R. Nacional, 6082, in SP at 1125 w/ slicked up Peruvian mx. Troubled by HCJB on 6075. (Jones, MISS)

SAUDI ARABIA BSKSA, 11855. In EG at 1900. Nx at 1915. (Zilmer, WISC)

SOUTH AFRICA SABC-Springbok R., 4810, in EG and Afrikaans at 0300 w/ Good Morning S. Africa px. Barnyard sounds, roosters crowing, ads for Peter Stuyvesant, and mx. (Jones, MISS)

SPAIN RNE, 9520, in SP at 0800 on this apparently unlisted freq for this service. Good level but mild QRM from HCJB. (Charles George, TEX)

SPYLAND Unusual numbers stn on 14965. OC 2135-2225, then pips to 2230. Then W repeats same three numbers to 2240. (E.g., 4-2-5 on 9 Jan; 9-2-9 on 10 Jan.) More OC to abrupt s/off at 2241. (Gilbert Morlan, CAL)

SRI LANKA SLBC, 9720, in EG at 1845-1945 during a test tx; mixture of local and EG pop mx, frequent requests for listener mail and opinions. Engineer/announcer also solicited advertisers and made frequent references to test nature of tx. (Barry Frajer, NY) +++ Plans for a DW relay stn at Trincomalee have been finalized according to a report by Oliver T. Goonewardena in UADX 50. The facility is expected to be ready within a year w/ two 250 kW transmitters beamed to Asia and Oceania. (UADX 50) *** Congratulations to editor (and good friend) Victor Gonetilleke and everyone in the Union of Asian DXers on their 50th bulletin from all of us. Continued success and the best DX. tba

SURINAM SRS, 4850, at 0905 w/ nx by M in lang and very strong sigs. Also noted w/ apparent live futbol game between Australia and Mexico and DT announcers at 0125. (Bishop, PA) Also noted on 4850 to 0330v* from 17 January w/ usual px. (McNeil, DC). Noted almost nightly on same freq w/ MOR EG rock and DT mx. NA at 0330 s/off then abruptly off. (Word, GA) Heard on 4850 during evening of 11 Jan in awful mess w/ Clarin back on. Why doesn't someone grab 4950 ??? (Perdue, ALA) *** AGREED!!! tba

SWAZILAND TWR, 4760, *0356 w/ bells IS and into GM past 0430; also noted one night on 5055 w/ EG religious px at 0420 but not noted since. Tentatively noted on 4790- at 0315. (McNeil, DC)

SWEDEN RS, 11850 NF, in EG to WNAW from 0230-0300 replacing 11705. (Zilmer, WISC)

SWITZERLAND SBC has dropped 15305 in favor of 9765 NF for its 1315-1345 EG tx. (Zilmer, WISC)

SYRIA Damascus, 6200, presumed here at 1945 w/ AR talk by M about Arabiya and regional mx. No ID and buried by RM co-channel and BBC off by 5 kHz at 2000. Not Tirana, as px continued w/o break at the hour. (Bishop, PA)

USSR Kalinin, 4055, at *0400 w/ M3 px, not the *0530 listed in TBS-5. (McNeil, DC)

YEMEN ARAB. REP. Sanaa, 4853, in AR, 0410-0420 w/ Arabic mx, then brief talks by M. Reception very good for 10 minutes, then suddenly much worse. (Frajer, NY)

FROM THE EDITOR: As you can see we have plenty of room for material; nonetheless, welcome to a sizable number of new faces. Hope you'll all become regular UPDATERS.

Since the last issue, I've been asked about how strictly deadlines must be enforced. Policy is this: For the mid-month issue I can be somewhat flexible, and will therefore accept phone material within 24-36 hours after the printed deadline. I also allow some extra time if the mails appear to be running even slower than usual. FOR ISSUES APPEARING IN FRENCH, HOWEVER, I CANNOT ACCEPT COPY AFTER 7p.m. CENTRAL TIME ON THE DATE OF THE DEADLINE. THIS IS NECESSARY TO MEET MAILING AND PRINTING SCHEDULES. Thanks for your help in observing these deadlines. (If material comes too late for one issue, I ordinarily save it for the next.)

73s to all---

Tom

log report section



Ed. Sec-A: Dan Robinson

1601 - 4900

FEBRUARY 1978

5004 Fulton St., N.W.
Washington, D.C. 20016
(202) 686-1683

As we go to print from Levittown, much of the country will be digging out from under heavy snowfall. Speaking of snow and cold, please note the following address change for Greg Ravenhorst: Rural Route, Hollandale, MN 56045, and remember that the deadline for reports to Greg is the 12th of the month. Interesting things continue to happen in the lower bands, and in the high frequencies as well. On January 1, I was pleased to catch FRBC, a Dutch pirate on 6,214--but we'll leave that for Tom to report in Section C. LR-A has its own pirate(s) this time around, from New York!!

SPOTLIGHT SPOTLIGHT SPOTLIGHT SPOTLIGHT SPOTLIGHT SPOTLIGHT

USA: WICE "Free Speech Radio" is being reported widely as of this writing, a pirate from New York City (according to anmts). Most recently measured on 1626.5, was // 3261 on 1/21 from 0504 through 0730 t/o. IDs as "WICE 1625," "This is ICY Radio, WICE" Frequency varies from 1625 to 1630. On 1/21, fairly professional-sounding talk show host taking calls ranging from Albany to Washington, D.C., most of them lacking much intelligent content. Said that WGOR is also on the same frequency, and the two are likely closely related if not one and the same. "You learn a lot when you go on a pirate radio station...a lot about people" In DX HOTLINE of Feb. '76, Bob Foxworth reported on WCPH with just such a talk show/free radio format, and postulated that the telephone numbers used (most recently 626-9906 & 830-9900) are "internal usage loops" for phone company purposes only. Thus, one of the participants might well be a "frame-man for Telco and going up into the frames and either clipping across (exchanges) onto another phone line which reaches the radio station, or arranging for a transfer of calls onto an otherwise unidentified line." Presently, seems to run an extended/extensive schedule with current and oldies music, Simon & Garfunkel, etc...Many calls from Brooklyn which led Foxworth to believe the location was there...And, when one calls, the line is simply busy until you get through--but there is no actual ringing, only a quick connection. Whether they knew of the harmonic 90 meter frequency I don't know, but when I called I was led to suspect they might--they were very evasive about studio equipment in response to caller's queries, understandably so (Robinson 1/21/1/22 credit to Bob Foxworth)

- 2340 CHINA Fujian: 1429 in CH w/tlk by M& W (Bryan 12/30)
2340 COLOMBIA LV de la Heroica: 0330 SP, pop mx, ments of Bogota, ID (Bishop)
2390 MEXICO R Huayacocotla: 0030-0200 SP, back here after short absence, often 20/S-9 w/M&W ancrs, Mexican mx, many IDs (Perdue) 0140-0206* M&W in tlk, fast guitars and fiddles--LV de Atitlan probably here during/after s/off (Osterman)
2390 GUATEMALA LV de Atitlan: 1115-1125 SP, Latin "Gaucho" mx, M w/ID, heavy noise (Blaise 12/28)
2428 PAPUA NEW GUINEA R New Ireland: 1253 Pidgin, rx by W, then ID by M, NA 1300* (Bishop 12/28)
2490 BRAZIL R Educadora Rural, Coari, Amazonas: Barely audible but some f/ins; listed 250w; 12/31 0130 w/rocky mx, ID seems to be just "R. Coari(koh-ah-REE)" PT anmt 0222 and off 0226 w/"Boa Noite" and a bit from the overture to Russian & Ludmilla (Hauser)
2850 N. KOREA Pyongyang: 1445 in KR, W in tlk (Bryan 12/30)
2920H NICARAGUA Ecoe de las Brumas: 0430 w/lively I AM mx; 0504 ID said would be on until 4 a.m.; strongest harmonic heard in Miami 1/5(Hauser)
2950T HAITI LV du Peuple: Previously hrd here, 2x1475; 0305 in seeming Creole French (Hauser, PR/FL)

- 2960 CHINA Changchung: 0930 CH, lots of CH tlk by M (Prath 12/26)
- 3060 NUMBERS 0107--actually letters noted strong lvl, not obviously local(Hauser)
- 3137 GUYANA GBS: Caribbean-type EG noted 12/31 at 0235, and I envisioned an off-Frequency 3rd harmonic of 1045; but IDed as GBS giving 2 MW freqs, and usual 3.29, 5.95 SW; couldn't tell if actually on 3290 or not, but this 3137 does not work out as harmonic of any known MW freq of theirs(Hauser-PR 12/31)
- Here 0830 1/1 with excellent sigs; no sign of 3290--IR
- 3160H DCM REP. Local rx items and ads 2145 12/28; 2203 ID "Somos la emisora del pueblo" Two Dominicans listed 1580, R Neyba the one w/harmonic here in past (Hauser-PR)
- 3200 CHINA PLA: 1115-1130 CH, M w/tlk, CH mx //3400, 3900 (Sherman 1/6)
- 3210 MOZAMBIQUE RM: 0255-0327 PT, s/on w/NA, ID, M w/world nx; pop mx later on, larg anmts and tlk(5 rpters) 2155-2212* PT, instrumental mx, PT nx 2200, NA 2212(Cannon 1/2)
- 3213 SULawesi RRI-Ujung Pandang: ID 1329 IN, "GOJOONG PAHH DAHNG" and into W with rock mx (Poppin 12/28)
- 3222 TCGO Lama Kara: 2140-2220 FR, African chants/vocal mx, M in tlk, FR pops, local mx (Cannon, Osterman, Yajko)
- 3225 VENEZUELA R Occidente: 1101 SP, anmts, LA mx (Strawman 1/2)
- 3227 LIBERIA ELWA: 2158 in vern, M w/tlk not //4770 which had VOA nx in EG(Osterman 2206-2215 vern, African mx and tlks (Cannon 1/1)
- 3232 CONGO RTVC: 2215 FR, M w/tlk, seemed // 4765 (Osterman 1/3)
- 3241 MOLUCCAS RRI-Ambon: 1200 in IN, lcl ID into Jakarta nx relay; hrd during auroral disturbances (Hywarren 12/29)
- 3245 VENEZUELA R Libertador: 0330-0357* SP, M/W ancrs, variety of LA and EL mx, IDs, s/off with march and NA(Perdue 12/19)
- 3250 SOUTH AFRICA SABC: 0119 EG, with dance mx (Leffler) 0250-0254 EG/AK, mx(Filka)
- 3250 KALIMANTAN RRI Banjarmasin: 1200 w/Indo pops, lcl ID, then nx(Hywarren 12/29)
- 3255 VENEZUELA LV del Tigre: 1115 SP, fast tlk w/2 M ancrs (Prath) 1046 SP mx, fast tlk, LA mx (Strawman 1/2) 1009 with LA vocals, ID(Richezza)
- 3260 ECUADOR LV del Rio Carrizal: 0225 SP, LA/Ecuadorian mx, electronic, M ancr, IDs--takes a good night(Perdue 12/19) Thanks Neal--DR...
- 3285 BELIZE RB: 0320 EG, pop mx, IDs, comedy (Sandborn 12/30)
- 3290 PAPUA NEW GUINEA R Central Province: 1131 Pidgin, booming lvl w/Pidgin TC and ID; modulation was poor however (Pinchuk 1/7) Nice Bob--DR
- 3300 GUATEMALA R Cultural: 2350-0000 SP, strong sigs, rel. songs, M in tlk(Gallagher) 0240 EG w/Christmas songs(Sandborn 12/19) 0310 EG, rel. pgm (Alexander)
- 3316 SIERRA LEONE SLEB: 2125 EG, M w/PSAs, TC 2135(Bishop) 2241 pop mx, lcl nx by M (Osterman) 2255 EG, ID-"This is the SLEB"(Onken) 0646 in vern, percussion mx and vocals (Cress 1/4) 0713-0715 EG, local nx by M/W; police offered reward for stolen safe...(Dunn 12/10)
- 3320 SOUTH AFRICA Radio 5: 0340 EG, pop mx, IDs and TC (Valko 12/2) Thanks for the card Dave....
- 3322 PAPUA NEW GUINEA R North Solomons: 1220-1245 EG/Pidgin, C&W mx, ID, TC(Osterman) NA prior to 1300* (Poppin)
- 3325 ECUADOR Ondas Quevedenas: 0410-0440t/o SP, lively folk mx, chimes, clear ID 0435, tlks by M, F (Florian 12/29)
- 3325T GUATEMALA R Maya: 1204-1225 hymns in UNID lang, (Blaize 12/28)
- 3335 SUMATRA RRI Banda Aceh: 1201 IN, Jakarta nx relay, QRM CHU (Hywarren 12/29)
- 3340 ECUADOR R Tropical: 0210 SP, ID by M, LA mx (Taylor 12/24)
- 3360 GUATEMALA LV de Nahuala: 1106-1115 SP, Marimba type mx with SP tlks, ID (Blaize 12/28) 0145 SP, tlks and LA mx, 0200 ID (Strawman 1/10)
- 3365T BRAZIL R Cultura de Araraquara: 0830 in PT, M ancr but no ID hrd; nice vocals by W and old US Top 40 hits, F (Hywarren 12/17)
- 3366 UNID: 0324 SP, good signals but UTE QRM, LA "Gaucho" mx w/muffled tlk by M (Richezza)
- 3366 GHANA GBC: 2125 EG, rx about UN session on So. Africa(Dunn) 2245 w/nx, s/off with NA (Cannon 1/2)
- 3380 ECUADOR R. Iris: 1115-1125 SP, "Mexican" type mx with accordians and two fine IDs (Blaize 12/28) 1159 w/mx, ID, TC (Jones 1/1) 0247-59 SP, live Ecuadorian mx show, M/W ancrs, LA "Musica del Ecuador" pgm; XMTR problems 0259(Perdue 12/19)
- 3380 GUATEMALA R. Chortis: 0122 SP, tlks (Leffler 1/3)
- 3380 MALAWI MBC: 2202-2212* EG, organ and chorus in hymn, orch mx selection and off, F (Osterman 11/28)
- 3385 TIMOR RRI Kupang: 1100 with FULL ID, time pips and into Jakarta nx; QRM de Papua and Guinea, F; hrd during auroral disturbances (Hywarren 12/29)!!
- 3385 PAPUA NEW GUINEA RENB: 1212-1245 EG/Pidgin, pop mx, EG ID, TCs (Osterman) 1230-1245 Pidgin, religious Xmas songs, Noel, etc....(Sherman)

- 3385 FR GUIANA Cayenne: 0900-0950 FR, time pips, IS, ID, tlks in FR, mx(Taylor) "Ici Cayenne" into a pop pgm with M host(Hywarren 12/17) Pops, FR tlk(Osterman) Pops and ads; Paris nx at 0930, 0942 back to Cayenne (Hansen 12/31) Mx and tlks(Tannenwald) 0350-0402* with FR tlks by M, pop mx, TC/freqs by W, then "La Marseillaise and the IS (Delap 1/14)
- 3390 ECUADOR R Zaracay: 1100 SP, ID and Ecuadorian mx (Strawman 1/2) 1120 SP, many good IDs, various potpourri of mx, SP tlk(Blaise 12/28) 1109 with frequent IDs(McCarthy 1/1) 0340-0351 LA mx, Ecuadorian mx(Bryan, Alexander)
- 3395 VENEZUELA R Universidades: 1110 SP, LA mx, M w/ID(Blaise 12/28)0010 SP tlk, ID, pop YV mx and ad for GE(Cannon) 0204 LA mx, IDs(Strawman) 0254(Filka)
- 3395 SUMATRA RRI Tanjungkarang: 1300 IN, Jakarta nx, F (Hywarren 12/29) Nice...DR
- 3396 NIGERIA NEC-Kaduna: 2205-2240 EG, US pops, ID 2215, also in lang(Bishop, Osterman)
- 3396 RHODESIA RBC: 0355-0405 EG, Mx and ID 0400(Blossom 12/30)0400(Sarrazin)
- 3425 NEPAL RN: Hrd daily 1245-1435 Nepali; short smts, lcl mx--seems ME, HS. Asian--often excellent signals(Sarrazin) 1239 in Nepali(Strawman 1/2) 1501 W ancr and lcl mx(Bryan 12/30)
- 3550T WEST TIMOR RRI-Kupang: 1202 IN, barely audible w/weak sigs, tlk by M, but strongest lvl was S3(Pinchuk 1/6)
- 3810 ECUADOR HD210A: 0940-0950 w/usual pips, IDs(McCants 1/5)
- 3892 N. KOREA Pyongyang: 0953 in RS cmnty about American imperialism cont'd until 1000(Poppin 12/18)
- 3905 ADMIRALTY IS R Manus: 1157 Pidgin, chime at 1200 and ID by M in Pidgin ment Admiralty Island, followed by weather(Poppin 12/22)0805-0830 with Silent Night and other carols w/ M&W smts between(Sarrazin 12/25)Orange Crush--a soft drink?
- 3910 JAPAN FEN: 0733-0742 EG, with US big band orch mx(Poppin 12/29)
- 3925 PAPUA NEW GUINEA NBC: 1322-1328 EG, pop mx, calculator ad, Xmas song //4890 (Osterman 12/23)
- 3945 BALI & LESSER SUNDA IS RRI-Denpasar: 1059 w/subcontinental mx; 1100 M ancr into nx relay in Jakarta; QRM de AROs & NSB--no ID hrd(Hywarren 12/29)
- 3952 GT. BRITAIN BBC: 0710 in EG, nx then commentary //3970(Hywarren 1/1) 0125 EG with "Outlook"(Leffler 1/3)
- 3975 GT. BRITAIN BBC: 0128 in Urdu, tlks with nx following(Leffler 1/3)
- 3980 SOUTH AFRICA SABC: 0310 AK, pop mx and ads (Grenier 1/6)
- 3985 CHINA RP: 1354 in presumed CH tlk; hrd Internationale at 1354 w/1355*--my first record of this freq...(Poppin 1/5)
- 3995 W. GERMANY DW: 0130 GM, with operatic fare (Leffler 1/3)
- 3995 ASIATIC SSR Nikolayevsk na Amure: 1354 RS with pop mx, chime and TC "17 hrs Moscow Time, Mayak in Progress..." Literally "Working" Nx bulletin after (Poppin 12/19) 1513 RS folk mx, vocal and inst (Bryan)
- 4040 ASIATIC SSR Vladivostok: 1246-1300 RS with "Govorit Moskva" and TC for 16 Chasov(Poppin 12/16) 1518 RS folk mx //3995 with same pgm(Bryan 12/30)
- 4055 USSR Kalinin: Beautiful RS folk songs and vocal harmonization; Moscow TC at 0532, into tlk by M in RS; //4860 also Kalinin listed(Robinson 12/31)
- 4110 CHINA RP: 0029-0045 hrd a definite RP IS here, f/b a W in lang tlks...If WRTVH is still right, this is Urumqi(Delap 1/1)
- 4115 N. KOREA VORPR: 1403 EG, ID and W in commentary about achievements in 1977; possible ID by W 1428 (Poppin 1/5)
- 4200T CHINA RP: 1408 with W in commentary, 1413 oriental orch mx, 1414 M in cantry; TBS lists as possibly inactive(Poppin 1/5)
- 4395 ASIATIC SSR Yakutsk: 1516 RS, W in brief description of songs and mx pgm, vocals and orch mx (Poppin 11/29)
- 4400T CHINA Xinjiang: Listed in WRTVH; 1509 CH with W vocalist, 1513 Internationale and power off(Poppin 12/4) SRTY George, did they s/off with Internationale??? You say not on your report...keep on eye on this one(ear)...DR
- 4485 ASIATIC SSR Petropavlovsk: 1359 RS, popular mx, G(Strawman 1/2) 1532 w/RS contemporary mx/ID by W and nx (Bryan 12/30)
- 4585 USSR UNID: 1334 RS, Mayak pgm w/pop mx and piano; not listed(Poppin 12/19) Sure this is not a feeder George?--DR
- 4680 ECUADOR R Nac Espejo: 0049 SP, vocal with piano (Leffler 1/3) 0248-0302 w/mx pgm and ID 0301 (Earhart)
- 4696 BOLIVIA R Riberalta: 0356 t/in with Male chorus, childrens chorus songs; 0400 w/TC and many mentions of Beni; into series of chorus and Ranchera style mx, F (Hywarren 12/10 UMDX)
- 4698 JAVA R KIP Surabaya: 1115-1124 IN, tlk by M (Poppin)
- 4719 SULAWESI RRI Ujung Pandang: 1100-1300* IN, lcl piano IS 1100, ID, into nx; IN tlks by M ancr, island mx; //4986 on past 1300 w/time pips and nx; also nx at 1200(? rptre)
- 4725 BURMA BBS: 1140 in presumed Burmese, tlk by W; ID 1200 by W at strong lvl, same day as Palangkaraya(Pinchuk 1/5) 1432 W in tlks(Poppin 1/5)

- 4750 CAMEROUN R. Bertous: 2000-2030* FR, peppy African rock mx, w/male ancr to 2030 s/off(Pinchuk 12/8)
- 4755 COLOMBIA Emisora Nuevo Mundo: 1100 SP, news and tlk w/2 M(Prath 12/26) 1111 w/SP mx, F(Strawman 1/2) 0052 in tlks(Leffler) 0502 w/mx(Poppin 12/2)
- 4770 VENEZUELA R. Bolivar: 1100-1200 & 0000-0445 SP, IDs and pop tunes, LA mx; YV style mx(12 rpters)
- 4770 LIBERIA ELWA: 2106 EG; mx request pgm(Dunn) 2150 EG, tlks about real meaning of Christmas, mx (Taylor 12/23)
- 4775 INDIA AIR-Gauhati: 1205-1215* in lang; sub-continental mx/chants, EG ID, M in tlk, short march and off (Osterman 12/14)
- 4775 AFGHANISTAN RA: FS *1259-1312 Urdu, carrier on 1256, RA IS, M in tlk, chants, W in tlk (Osterman 12/14)
- 4777 GABON RTVG: 2235 FR, African tunes, M ancr and ID, G w/QRN(Hywarren 12/25) 0521 w/popular African mx and ancr in FR(Cannon)
- 4779 Cf the last two LR-A's: I didn't think it possible to make two mistakes in a row on a frequency, but I've accomplished that....Surinam should have been listed as 4779^{1/2}--DR
- 4780 SURINAM SRS: 0305 EG, EL mx pgm w/erotic-sounding W ancr giving New Years wishes to DXers, many IDs; s/off 0330 after NA(Hywarren 1/2) 0315-0330* w/the same on 1/2(Florian) 0422-0432* DT/EG, pop song in "Early Sunday Morning Show" (Osterman) 1009 pop mx, amts in DT, full ID 1015(Hansen) Guess what folks... SEE 4850--DR
- 4780 VENEZUELA LV de Carabobo: 2145 SP, mx and W vocalist (Leffler 1/2)
- 4780 KARELO-FINNISH SSR Petrozavodsk: 0400 time pips and into RS tlks pgm; then played some fast RS mx; no ID hrd(Gavaras 12/24) 0608 (Earhart)
- 4781 HONDURAS R Juticalpa: 1140 SP, M w/ID, LA mx and vocals (Osterman 12/17) 1235 instrumental and Christian hymns, no amts/no ID hrd(Lineback)
- 4781 DJIBOUTI: 1302-1310 w/Afar and ME sounding chants, a short anmt, more chants w/some African type mx; no ID, but positive of freq; only hrd once(Sarrazin) Time just doesn't sound right Dave though I've hrd Djibouti on West coast LP at times--check it again if you can and let me know--DR
- 4785 COLOMBIA Ecos del Combeima: 0715 SP, typical HJ/R Super format with ads and many Super IDs; May have moved here fm 4875 to avoid LV del Norte(Hywarren 1/1) 0350-0407 LA mx, tlks, ID--move fm 4875(Florian 1/2) 0910 IDs and TCs; tuned 0605 0920 and found // 4785(Hansen 1/1) 0600 w/strong sigs, and canned IDs (Bishop) 0610 (Cress 1/4) 0332-0530(Jones, Lineback)
- 4785v TANZANIA RT: 2035-2102* SH, African instrumentals and chanting, nx to 2055 in SH, NA 2102* (Cannon 12/31) 0359 drums, time pips at 0400, EG ID and into nx, F w/QSB and HET (Hywarren 12/28)
- 4785 AZERBAIJAN SSR Baku: 0200 RS, two NAs, ID, nx by W/M and string mx to 0230 f/o (Bishop 12/21)
- 4790 PERU R Atlantida: 1100 SP, mx and ID (Tannenwald) 0200 several IDs, TC, amts (Yajko 1/1) 0431 soft Peruvian instrumental mx, SP tlks and many IDs(Cannon)
- 4795T USSR UNID: 1443 RS, piano solo, W in cmty; 1445 organ w/musical chime f/b W "The latest news..." M&W in nx after(Poppin 1/5) Two Soviet stns listed TBS...
- 4795 ECUADOR LV de los Caras: 0055 SP, mx and very weak sigs(Leffler 1/3)
- 4800 VENEZUELA R Lara: 1100 SP, mx and M DJ(Prath 12/31) 2140-0315 LA mx, IDs, tlks and musica Venezolana(Leffler, Grenier, Cannon)
- 4805 DOM REP R Norte: 2235-2245 SP, IDs and pop LA mx(Cannon)This rpt fm 11/5--DR
- 4807v SAO TOME E PRINCIPE R Nac: 2045-2301* light mx, gorg, TC and Radiodifusao Nacional ID 2100; HET de SABC 4810 at this time but GREAT LEVEL(Roberts-UMDX) PT w/lcl pops and M in tlk(Bishop) Nx and tlks, drums(Osterman) 0615 PT, clear R. Nacional ID, rock-like percussion mx and vocals, slow guitar solo 0630(Cress) In the clear here 0600--DR
- 4810 ARMENIAN SSR Yerevan: Noted 12/31 in //4780, 5040, 5065 at 0500 w/F-G signals, an excellent Soviet night(Robinson) 0500-0509 UNID, nx by M&W(Earhart)
- 4810 GALAPAGOS IS LVG: 0130-0230 SP, "Esta es La Voz de Galapagos..." with nice Programa Musical (Sarrazin) 0225 EL mx, ID by M, program promos, mentions of Christmas, Jingle Bells by orch(Taylor 12/24)
- 4810 SOUTH AFRICA SABC: 2000-2119*/v and 0300-0425 w/mx, commercials, frequent TCs, IDs, cig ads; EG/AK;amts; also runs past 2119*(Bohlike, Desrosiers, Plotnick, Berezowski, Brouillette, and 8 other rpters)
- 4815 COLOMBIA R Guatupuri: 1020 SP, pop mx and M DJ(Prath) 0057 w/musica Colombianas (Leffler) 1114 M in tlks, LA mx (Strawman) 0443-0503* w/ballads, frequent IDs (Bohlike 1/3) 0445 w/Xmas celebration(Tannenwald)
- 4815 UPPER VOLTA RTV: 0620 FR tlk by M, some instrumental Christmas mx, possible ID; nx pgm (Gavaras 12/23)
- 4820 HONDURAS HRVC: 2340-2350 SP, religious SP tlks and mx; a few IDs(Cannon) 0300-0400 in EG pgm, IDs, Night Sounds, religious tlk by M; 0400* and ID as "Voice of Honduras"; another s/off was 0556*(Burke, Blaise, Desrosiers, Cannon, Sandborn, Earhart)

- 4825T USSR RM: 2132 in CH; W in tlk, 2159 RM IS and into lang pgm, G-F...what is the site??(Hywarren 12/29) I guess Ashkabad--DR
- 4830T THAILAND RT: 1501-1517 in tlk by M&W in presumed Thai, slow organ mx, soap-opera type dialogue(Poppin 1/5)
- 4832 COSTA RICA R Reloj: 2149-0803 with usual SP tlk and mx, IDs, nx, ads(Sandborn, Leffler, Desrosiers, Tiers)
- 4835 SOUTH AFRICA SABC: 2135 EG, pop mx pgm, song by Neil Diamond, anmts(Kukan) 0411 M with agricultural nx, Springbok Radio pgm(Bryan)
- 4835 SARAWAK RM: 1414 in Malaysian w/M in tlk, UTE QRM (Hywarren 12/6) 1549 in Bahasa Malaysia, M with chants(Bryan)
- 4840 VENEZUELA R Valera: 2220-2235 SP, many IDs and soft YV classical mx(Cannon)
- 4843T CONGO Pt Noire: 0510-0520 FR/vern tlks--could be Nouakchott drifting(Lineback) That's what I like to see, caution in reporting--DR
- 4844 HONDURAS R San Ysidro: 0055-0200 SP, Xmas and LA mx, IDs, hrd one weekend only. Expected them for Xmas, but R, Bucaramanga came back on 4845; next chance will be Easter Eve if Bucaramanga off(Perdue 12/4,5) Thanks Neal.... 0100 w/Id, ads and mx(Leffler 1/3) Sure about this Irv??--DR
- 4845 MOLUCCAS RRI Ambon: 1152 with local string mx and screechy voiced W ancr, G (Pinchuk 1/6) 1347-1400* IN, pop mx, tlks by M, s/off anmt and Love Ambon at 1358 (Florian 12/29)
- 4845 BOTSWANA RB: 0340-0410 w/long cowbell and moo IS, anthem 0400, EG ID, into 1cl mx. That cowbell IS varies as to starting time, but this evening it began quite early (Gallagher 12/30) 0441-0511 Setswana tlks by snrcr, African drum and chants/mx, nx 0505(Cannon)
- 4845 MALAYSIA RM: 1518 in Indian lang w/sub-cont mx and drums, vocals(Poppin 1/5)
- 4845 MAURITANIA Rdf Nationale: 2150-2340 AR, tlks and mx, string mx, chants (Leffler, Cannon, Valko) 0600-0713 AR, drums and guitar, IS and IDs, tlk by M, Koran (Poppin, Taylor, Blaize)
- 4845 COLOMBIA R Bucaramanga: 1100-1200 and 0000-0400* SP/EG with M ancr, ID and mention of "International Program of R Bucaramanga..." Pgm of Colombian mx (Hywarren 1/6) 1145 w/mx about Colombia, ads, IDs(Blaize) 0020 back here w/LA and Xmas mx, IDs, also plugs for Guatapurí, et al(Perdue) EG/SP anmts hrd with NA at 0404 s/off on 1/6(Jones) 0330-0405 mx, SP/EG IDs "From the progressive country of Colombia..." 1 KW per WRTVH (Fleck) 0310(Lineback)
- 4850 CAMEROON R Yaounde: 2125-2258* and 0500-0544 FR at 2125 w/US rock, W DJ, 7/9745(MacKay) 0505 w/vocals and drums(Lineback) 0536 w/mx(Bryan) 2258* at strong 1vl, 1cl and pop mx, "R Cameroun"ID and off with NA (Perdue) 0544 with balafon mx (Poppin)
- 4852 YEMEN Sanaa: 0320-0335 AR, vocals and anmts at 0330, then tlks (Lineback)
- 4850 VENEZUELA R Capital: 0416 in SP w/US pops, "Radio Capi-tal" singing IDs, F(Hywarren) 1046 with ads, singing ID, "Noticiera Capital." (Jones) Sorry for the out of order--DR
- 4850 ECUADOR Ondas del Zamora: 0130-0320 SP, LA and US mx, overmodulated anmts and IDs by M (Perdue 12/8) This, the one with Canal Juvenile IDs rptd earlier... they should all move off this freq and let Surinam stay put, see next item--DR
- 4850NF SURINAM SRS: In another move, they are back here with booming signals and little QRM. These frequency moves are driving everyone crazy, and sooner or later these stations will have to agree on set numbers or complain in 1979 at the WARC conference--editorial comment DR
- 4855 BRASIL RC do Para: 0315 with tlks by M in PT (Lineback)
- 4855 SUMATRA RRI Palembang: 1413-1446 IN, with mx and nx (Poppin)
- 4860 PERU R Chinchaycocha: 1010-1024 with local mx, TC/ID, in SP(Sapoznikow 1/1) 0200-0215 hrd early in absence of R Maracaibo; LA and Andean mx, ID--mentions of Ecuador so beware when chasing Radio Mundial I (Perdue 12/19) 0430 full ID, ads and into Pop/EL mx; mentions of Junin (Hywarren 12/17)
- 4865 COLOMBIA LV del Cinaruco: 1116, SP, commercials, early morning pgm, ID, ECUADOR CARACOL ID (Jones 12/16)
- 4865 BRUNEI RB: 1331-1431* ID as "Inllah....Brunei", rock mx, vocals and comments, Islam prayer 1423 and off 1431(Poppin 12/2) Is this exactly 4865 or low/high??--DR
- 4870 BENIN LVR: 2152 FR, 1cl mx and drums, vocals(Leffler 1/2) 0415 FR/vern tlk, mx, ID 0455 (Desrosiers 12/16) 0530 w/vocals and 1cl pop(Bryan) 0614(Poppin)
- 4872 IRIAN JAYA RRI Sorong: 1301 with Jakarta SP, mx by M/w, G(Hywarren 12/29)
- 4875 BOLIVIA La Cruz del Sur: 0210-0234 SP, IDs, mx, but not religious(Valko 12/15)
- 4875v IRIAN JAYA RRI Sorong: 1343-1400* IN, tlk by M&W, pop mx, s/off anmt 1357, and into Love Ambon(Florian 12/29)
- 4880 VENEZUELA R Universo: 1135 SP, LA mx and IDs (Alexander 12/31) 1150-1200 singing IDs, ads and tlk(Blaize) 2153 (Leffler 1/2)
- 4880 SOUTH AFRICA SABC: 0406 AK, conversation between M ancrc(Florian 1/2) 0435 with pop mx(Poppin 12/2)

- 4885 COLOMBIA Ondas del Meta: 0858 w/Coca-Cola ad, ID in SP 0858, orch and vocal mx (Hansen) 1119 w/LA guitar mx(Strawman 1/2) 0630 w/2 step Colombian mx w/ accordians--(Blaise) 0230 ID, Colombian mx, CW QRM fm KKN-44: US Embassy in Monrovia (Cohen 1/3)
- 4890 PAPUA NEW GUINEA NEC: 0740-1400* w/US pop and disco, also South Sea Island style mx; ID 1300; EG tlks(10 rpters) 0855-0926 EG, mx, TCs, mx forecast, ads, rx--There was an item on the rx about the rat problem in PNG. They wanted cats to combat the problem. Anor said "although any breed and color of cats are welcomed, preference will be given to those with rat-killing experience" (Ihnat 12/27) Now that's funny.....IR
- 4890 SENEGAL Rdif du Senegal: 2205-2242 FR, instrumental mx, tlks, QRM fm Rdif Venezolana(McCarthy) 0645 FR, tlk by M, string mx, time pips, drums, ID, and rx by M (Taylor 12/27)
- 4895 SARAWAK RM: 1415 brief ID by W and into rx by M; Fair and //4950(Hywarren 12/16) Aaron--//4950 Sarawak or 4970 Sabah??!--DR
- 4895 CHINA Huhhot: 1500 CH, East is Red sung by chorus (Poppin)
- 4900 VENEZUELA R Juventud: 2154 SP, US pop mx, ads(Alexander 12/31) 2245 w/rock mx (Leffler 1/2) 0130-0206 pop mx, Beatle record ads, much use of echo chamber, rock arrangement of "Deck the Halls"(Desrosiers) 0244 US pops, rx and ads (Burke 12/15)

ONE MISSORT BELOW.....

- 4890 ECUADOR R Centinela del Sur: 0445-0502* in SP with Ecuadorian pops, full ID for s/on, NA, then off at 0502* Good but QRM present(Hywarren 12/17)

A good increase in the number of reports this month so a thank you is in order, especially to the many new reporters to FRENEX. I had two requests/suggestions last month with regard to addresses and the size of reporting slips. I'd still like to have some more addresses from new members and those who have moved from previous locations. In cases where it becomes necessary for me to contact a reporter about a logging, this is very important. If I may, I'd like to add another request--TRY TO USE ABBREVIATIONS AS SPARSELY AS POSSIBLE. This may sound like a departure from usual custom, however I'm not saying to drop them altogether, just less. For example: W-TLK-M-TLK-M-TLK could become: Tlk by woman/man with music interspersed or Tlk by M&W, Mx in between. In short, just take a look at your reports before sending them in and try to decode them. Makes IR-A a bit easier to read, and I usually try to type this section up at about a 70-80 w.p.m. clip so it makes for easier typing as well.

As I close, WGR was noted back on 1630 in place of WICE. Its not often that we get a pirate that is so widely heard, but indications are here in Washington from FCC sources that action has been taken already to silence the station(s)....Until March,

73a-----DAN

HELPING HAND For Sale. Barlow-Wadley XCR-30 portable receiver, model w/silvered, not grey painted dial area of front panel. fine condx. Best offer over \$175. FRG7, like new, seldom used, original carton, Best offer over \$225. Sears spirit duplicator machine ("Purple ink Ditto" type), manually operated, will print sheets up to 8 1/2 by 14 inches. Uses clean, easy to type carbon stencils and alcohol duplicating fluid, available at any office supply store. Less than 3 yrs old, works well. Bought new for \$110. Will sell for \$50. Perfect for publishing bulletins for small club, nxltr, etc. Add shipping to all above items. Also, WANTED: Have you a spare copy of the September 1977 FRENEX? Will pay postage and mint 31¢ airmail stamp for copy. Write first. Don Jensen 5204 70th St, Kenosha, WI 53142

HELPING HAND For Sale. Sony 10 Band Port, model CRF-5100, new cond, (only used 10-14 hours) original carton. \$235. FRG7 w/Gilfer Filter, excellent condx, original carton (9 months old). \$250. Gilfer MI antenna tuner, not used over 2 hours, \$30. Sony ICF-5900W, 3 months old, bought in Tokyo, excellent condx, \$95. Write: Gorman S. Cantrell, 1528, Hallam Dr, Lakeland, FL 33803 or call (not collect) 813-646-3524.

HELPING HAND Wanted. NASWA members who are able to tune a receiver and write down what they're hearing. If you qualify so far, then send in some reception reports for publication in FRENEX to: NASWA Distributing Editor, Greg Ravenhorst, Rural Route, Hollandale, MN 56045 (I should think that all 1600+ NASWA members should qualify! If not, lay off the Seagrams, & DX & write)

log report *section*

4900-6200kHz

B

Steven C. Wiseblood, 707 Loma Way, Santa Maria CA 93454

- 4905 BRASIL R. Religio Federal: PT 0110 with time signals (Tannenwald 12/26).
4905 CHAD RMT: M in FR 0544 with Afro news (Bryan 12/23).
4907 KAMPUCHEA R. Phnom-Penh: South-East Asian string and chanting music 1134-1200(Cannh)
W in CB with talk and flute music 1232-1300 (Osterman).
4910 ECUADOR Em. Gran Colombia: 0515-0520 Ecuadorian pop mx, SP ID (Perdue, Hywarren)
LA mx and SP mx and ads 1110 (Tannenwald 12/24).
4910 GUINEA R. Conarky: AR type chants 0520 (Lineback 12/17).
4919 GHANA OBC: "Inner Perspective" religious program, into ID and nx 2225-2229(Jones,
Tiers). 0655-0705 Christmas mx, ID, EG nx 0700+ (Poppin, Earhart).
4915 BRASIL Rdf. de Macapa: 0810-0935 PT amnts, Brazilian mx (Tannenwald, Hywarren)
4915 CHINA Nanning: W in CH w/talks, Orchretral mx 1425-1558(Hywarren, Bryan).
4920 USSR Yakutsk: SP rhythmic mx including the'TJ Brass"! , amnts in RS 1545 (Poppin).
4920 UKRAINE SSR R. Kiev: IS 2130, GM afterwards. Pair (MacKay).
4920 AUSTRALIA ABC: 0857-1314 EG mx, ID's, Classical mx, local time (Bogel, MacKay).
4920 HONDURAS R. Progreso: Slow vocal SP mx 0856, SP ID (Hansen-NY).
4925 BRASIL R. Taubate: M in PT w/accordion mx 0850 (Bishop).
4925 CHINA (Heilongjiang) Haerbin: CH orchestral mx 1217, W in CH (Sarrazin 12/31).
4926 ECUATORIAL GUINEA R. Ecuatorial: 2153 Afro chants & W in lang. w/mx (Hywarren).
Afro chants & local mx, M in verniculars 0553 (Bryan).
4927 INDONESIA RRI Jambi: Amnts by M in Indo 1456, Electronic organ mx, 1500 nx.(Poppin)
4930 DOMINICAN REPUBLIC R. Mil: 2310-0535 ballads & SP mx, ads(6 rpters) 1130 (Tannenwald)
4930 VENEZUELA "LV de la Fe": 2156 SP ads and TC's (Leffler 1/2) .
4930t TURKEMEN SSR Ashkhabad: Mazak Relay 1430, Could also be Tbilisi. (Hywarren 11/25)
4932 NIGERIA NBC: 2159 M in lang, time pipe 2200 then EG ID and nx. Pair (UMDX-Hywarren).
4935 BRASIL R. Capixaba: 2343-0010 PT vocal mx, TC's & numerous ads! (Bishop,Hywarreb).
4940 USSR (Asiatic) Yakutsk: RS 1604 w/"Anniversary Waltz" mx (Bryan 12/30) .
4940 IVORY COAST Abidjan: FR tlk 2200 & drum mx (Desrosiers). 0710 FR nx by M & W(Poppin)
4944 VIETNAM VOV: 1526 M in VT w/commentary, flute mx, electric organ mx (Poppin 1/5).
4945 COLOMBIA R. Colosal: 0104-0910 SP ads, rhythmic LA mx, ballads (7 reporters).
4950 SARAWAK 0945-1442, ID as "Radio Malaysia -Kuching", W in Lang., Soap opera(Poppin).
4951 PERU R. Madre de Dios: light mx, ID by M in SP, NA to 0403* (Bishop).
4960 ECUADOR R. Federacion: ID 0325, M in SP hosting music program (Perdue).
4960 VENEZUELA R. Sucre: LA vocal mx 0105 (Leffler).
4965 COLOMBIA R. Santa Fe: 0108-1124 lively LA mx, M in SP between songs (6 reporters).
4970 VENEZUELA R. Rumbos: 2200-0900 Ads, LA mx, M in SP, nx (9 reporters).
4970 ECUADOR R. Tarqui: Xmas mx, ID @ 0100, ads for a bank in Quito, Rumbos off (Bishop).
4975 COLOMBIA Ondas del Ortaqueza: 0300 Colombian pop mx, ID's by an OM, 0303* (Bishop).
4980 SWAZILAND Radio SR: pop mx & rock mx 0400-0410, tobacco ads, ID (Taylor, Bishop).
4980 GHANA OBC Ejura: 2238-2302* Xmas mx pgn in EG & verniculars (Kukan). 0621-0643
Cigarette ads, obituaries of local people, mx and talk (Dunn, Dubin, Utter).
4980 VENEZUELA Ecos del torbes: 2201-0410 EG ID, SP ads and ballads, 2 minute jingle,
"Happy Birthday" in SP (Florian, Hywarren, Leffler, Tannenwald, Earhart).
4980 UNID talk by M 1328-1402*, Middle-Eastern flavored mx, possible Burma. (Florian).
4985 BRASIL R. Brasil.Central: 0001-0744 Brazilian mx & ads (6 reporters)
4985 SULAWESI RRI: 1300-1310 M in IN w/talk, Island style mx (Osterman 12/12).
4990 VENEZUELA R. Barquisimeto: SP pop mx 1115, M in SP. (Prath).
4990 NIGERIA NBC: EG nx and commentary 0615 (Swanson).
4990 CHINA PBS Changsha: 0948 banjo type oriental mx, W in CH (Poppin)
4995 PERU R. Andina: 1040-1046 Local mx & ID (Sapoznikow).
5000 ITALY IEP: 0700, Morse code ID's, TC's; gave call in FR & EG, WWV QRM (Polaize)
5005 BULGARIA R. Sofia heard here in EG & RS w/Big Band mx 0530+ (McCarthy_FL, Spur???)
5010 CAMEROON R. Garoua 2025-2200 Afro mx, ID, FR & AR, chants, bells, IS (Bishop,
Desrosiers). 0510-0625 EG, FR & AR nx, Afro mx, Koran chanting (6 reporters)100kHz!
5010 COLOMBIA R. Surcolombiana: ID, NA @ 0940, ads and LA mx. Good. (6 reporters)
5010 NICARAGUA Rdf. Nacional de Nicaragua: Noted here only 12/9 w ID's, mx(Gallagher).
5015 USSR Asiatic SSR,Vladivostok: 1110-1415 Classical mx and RS vocals, RS tlk,
7/11495 (Zilmer, Alexander, Hywarren).
5025 BRASIL R. Barboresa: 0215-0331 Brazilian pop mx and PT amnts (Tannenwald, Bishop).
5030 VENEZUELA R. Continente: 0015-0310 SP ads, ID, Violin mx & LA mx(Hywarren, Prath,
Tannenwald, Leffler, Cohen, Alexander). -Prath heard it at 1105 w/ SP mx pgn

- 5030 SARAWAK RM Kuching: 1404 electric organ and vocal mx, ID, M in MA (Poppin).
- 5035 BRASIL R. Aparecida: ID's and pop mx 0034, mentions of Sao Paulo (Bishop 12/14).
- 5038 CENTRAL AFRICAN EMPIRE Voix de L'Empire Centrafricaines: 2224-2301* FR talk & mx (Valco 12/19). Xylophone, guitar mx and group singing, ID 0536 (Poppin 12/19)
- 5040 CHINA Fuzhou: 0758-0816 CH tlk by M&W, then to Quemoy (Brookwell 12/28)
- 5040 COLOMBIA R. Cinco: 0020 peppy LA mx, ads, TC's, ID (Hywarren 1/12)
- 5045 BRASIL Cultura do Para: 0225 Brazilian mx & ID (Tannenwald 12/25)
- 5046 INDONESIA RRI Yogyakarta: Band mx and vocal mx 1415 (Poppin 12/28)
- 5047 TOGO R-T: Xmas songs 2125, tlks by M in FR (Taylor 12/24.) 0600-0622 Drum mx, and speeches by M in FR. Over Cook Islands, hi. (Earhart, Gallagher).
- 5052 SINGAPORE RS: 1214-1616 Vocal pop mx and rock mx, ID by W (Poppin, Bryan, Kukan).
- 5057 ALBANIA R. Gjirokaster: 0524-0603 childrens chorus mx, W in AL (Dunn, Florian).
- 5060 ECUADOR Em. Progreso: 0550 Andean mx, ID's (Brookwell). 1151 vocal mx & ID (Poppin).
- 5075 COLOMBIA Sutatenza: SP educational pgm w/many ID's. //5095 (Hywarren). (Poppin/
- 5090 UNITED 1202-1232 EG tlk, then into Lang, string mx, distorted audio, partial ID/)
- 5095 COLOMBIA Sutatenza: 0114-0350 nx, ID, TC's, vocal mx, SP ads (Blaise, Leffler).
- 5115 CHINA R. Peking: possibly the one here with RS, drifting from 5145? (Poppin 12/31).
- 5125 CHINA R. Peking: Orchestral and chorus mx, tlk in Lang. 1230 (Zilmer).
- 5145 CHINA R. Peking: 1435 in CH w/tlks by M & W (Hywarren). I have EG listed! -sw
- 5163 CHINA R. Peking: 1230 female chorus mx, //6345 (Zilmer).
- 5170 CHINA PFBS/PLA Puzhou: 1230 chorus mx and CH talk (Zilmer 11/26).
- 5265 CHINA PFBS/PLA Puzhou: 1245 CH talk by M&W, //5240. CH mx (Zilmer 12/22).
- 5290 USSR Krasnoyarsk: Orchestral big-band type mx, RS news bulletin 1239 (Poppin 12/9)
- 5880 CHINA R. Peking: 2232 W in CH w/talk. Good. (Hywarren)
- 5882 ISRAEL IBA: Home service program in Hebrew, pop and rock mx, ads (Zilmer).
- 5886 INDONESIA RRI Pekanbaru: M in Indo w/light mx in background 1440 (Poppin).
- 5900 USSR R. Moscow: 0258-0405 EG nx, cmty, "Moscow Mailbag" (Hywarren, Zilmer, Bryan).
- 5900 ISRAEL IBA: 2230-2244 EG nx, IS & ID, DX Corner (Woltsman, Sandborn, Brown). 0445 SP nx (Zilmer). 0520 FR nx (Lineback 12/31).
- 5915 BULGARIA R. Sofia: 2132-2148 EG nx & discussion on coal production (Clark, Fraser). 0529 IS then into nx in Lang., this ex-9705? (Earhart).
- 5915 USSR R. P&P: SP talk 0408-0430 (Earhart). 'Tis a Bulgarian site -sw
- 5919 NICARAGUA Rdf. Nacional: 2340-1325 light SP vocals, nx & frequent ID's (19reporer's)
- 5930 CZECHOSLOVAKIA R. Prague: 1910 EG nx (Johnson). 2010-2015 "Weekend Magazine", ID's (Desrosiers). 2315 SP nx & ID (Tannenwald). *0100-0132 EG nx, commentary, sports (Prath, E. Miller, Leffler). *0200-0210 SP nx by M&W (Bohke). 0258_ 0334 EG nx, IS, ID, program review, asking for reports (Burke, Hascall, Welch).
- 5935 USSR (Latvian SSR) R. Riga: RS 0537, Choir mx and pop mx (Dunn). 0717 mx (Blaise).
- 5940 UKRAINE SSR R. Moscow: 0131-0200 EG nx, ID, commentary (Hascall, Sandborn, Leffler).
- 5940 USSR (Asiatic SSR). 1754-1900 Italian opera mx, RS folk mx, TC's (Poppin)
- 5950 GUYANA GBS Action Radio: 2145-2200* EG, mx & ID (Sherman). Need some pgm details-
- 5950 UNITED (USSR): 0720-0730 M&W in RS, Unknown location, //5935, mx (Blaise).
- 5954 COLOMBIA LV de los Centauros: 2340 LA pop mx, ID after each song (Cohen-NJ). 1030 Many ID's, LA mx (Zilmer).
- 5960 CANADA RCI: 2232-2238 EG nx, interviews and features (Bogel). 0140 SP nx & review of 1977 (Leffler, Hascall). 0300-0325 EG nx, Commentary, features (McCants).
- 5960 ANTIGUA DW: *0530-0550* EG, European nx and features (Blaise).
- 5965 NIGERIA NEC Jos: 2155 in Lang, M w/talks and Afro. rythms (Hywarren)
- 5970 PERU R. El Sol: 0540 ID, M&W in SP (Lineback). 1030 SP talk, mx (Zilmer).
- 5970 USSR (Asiatic SSR) Khabarovsk: 1420 RS pop mx to Mayak IS 1430, nx (Poppin).
- 5970 WEST GERMANY RFE: IS 0354, ID in Czech 0400, then into mx, unjammed (Hywarren).
- 5975 GREAT BRITAIN: 0308 EG world news, M in EG, talk about Carter (Bryan).
- 5980 USSR R. Moscow: EG 0015-0045 Commentary on SALT talks (McCants).
- 5985 MEXICO R. Mexico: 0058 SP talk, ID, Mexican mx (Taylor). 1324 ID by W, mx (Jones).
- 5985 BURMA BEB: 1536 light pop & rock mx to 1556, W in EG 1558, NA 1559 (Poppin).
- 5990 MALTA ISRA: 2030-2100 EG hymns and religious program (Hermann).
- 5990 JAPAN RJ: 0758 IS, full ID, NA, EG nx (Hywarren). 1415 M&W in JP, rock mx (Poppin).
- 5990 USSR (Asiatic SSR) Nikolayevsk: Mayak IS, time pipe & ID 0759 (Hywarren).
- 5990 ROMANIA R. Bucharest: 0130-0203 EG nx, tlk, commentary, IS, ID, "Radio Newsreel", "Mailbag" (Taylor, Leffler, Ihnat, Welch). 0412-0414 EG nx and comment (Earhart).
- 5995 VATICAN STATE V-R: *0100-0115* EG news, religious talk, stories, bells at IS, ID Songs "Going My Way", "Try to Remember". Popes Xmas message (5 reporters).
- 5995 AUSTRALIA RA: 1405-1534 EG nx and ID, pop mx (Poppin, Earhart, Beresowski).
- 6005 CANADA CFCZ: 1735-1930 EG wx, pop mx, "Radio-60", ID's (Alexander, Desrosiers).
- 6006 COSTA RICA R. Relejo: 0045 LA mx, SP talk, ID's, fluttery sigs (Gallagher). 1000-1200 Classical and pop mx, ID's, sounds bassy (Johnson, Hascall).
- 6010 PHILIPPINES VOA: 1320 EG nx (Lineback). Always a potent signal here! -sw
- 6010 USSR (European site): 1906-1929* EG nx to GB, poetry, Dutch at 1930 (Hermann). *2000 GM nx to Germany, ID and IS. (Brown). 2120-2127 EG talk abt Neutron bomb (Valco).
- 6010 ITALY RAI: 0110-0130 EG to NAM, ID followed by Xmas talk (Yacono, Brown).

Listeners NOTEBOOK

FEBRUARY 1978



• Editor: Glenn Hauser, WUOT, U-Tenn.,
232 C&E Bldg., Knoxville, TN 37916

PROPER CREDIT Other publications and broadcasters may use material from LN provided due credit is rendered to the original reporter and the NASWA Listeners Notebook. This courtesy does not extend to closed organizations which do not allow reciprocal access to their publications. BBC Monitoring Service items are copyright and may not be further reproduced without BBCMS permission. All times, days and dates are day/month GMT, unless otherwise specified.

ENGLISH SCHEDULES

VIETNAM VOV 1800-1900, 2030-2130 on 10040/14990/15012 (Phil Cox, Jan. WDXC Contact)

U S S R Regional Radio Centres' ES, Autumn/Winter 1977: Kiev via R. Moscow facilities at various sites: 1930-2000 to Eur 7360/6020/5970. 0030-0100 Ams 15100/11790/11690/9800/7400/7215/7150/6020. 0300-0330 Ams 12010/9800/9665/9635/9580/9470/7400/7360/7215/6020/5905.

Tashkent to SAs 1200-1230 & 1400-1430 on 9600/9540/6025/5945 (BBC MS Oct/Nov) Hrd on 5975 (Richard M. Utter, NY, SPEEDX, 2/12) BBC MS lists 5975 for R. Tashkent, used for other languages, as a relay via Alma Ata! (gh) Vilnius via R. Moscow facilities: 2230-2300 Eur 6100 + MW. 2300/2330 Ams 7400/7360/7215. **Yerevan** "The Voice of Armenia" 0325-0330 Sun/Wed/Thu/Sat Ams 9735/7130/6150 (BBCMS Oct/Nov) For Yerevan, BBC says nothing about it being via R. Moscow facilities, but DXers obs that these are via Far East sites far from Armenia (gh) Feeders carrying the R. Moscow Nam svc 2230-0400 are to Ukraine/Bulgaria, from Kalinin on 4860; Kazan on 6175 (Moscow); 0130-0300 9665 Chita; 9635 Vladivostok to Petropavlovsk 2230-0300; 9470 ?? from 0130 to 0300; 6020 Khabarovsk to Petropavlovsk 2230-0300. Here is a different version of regional stations, cf above: R. Kiev to East Nam 0030-0100 7150/7215, 0300-0330 7215/7360/7400. To West Nam 0030 on 11690/11790/15100. R. Vilnius to East Nam 2300-2330 7150/7215/7360/7400; to West Nam 11690/11790/15100. (December UHN)

U S A Current sked of WINB: 15340 1700-2100 Eu; 11775 2100-2300 Eu; 15170 2300-2400 Sam; 11710 0000-0330 Sam. in EG, except: 2045-2100 FR Wed, GK Fri. RS 1900-1930 Sat. SP 2315-2400 Mon-Fri. PT 0003-0030 Mon-Fri. Latin Mass 2200-2230 Sun (ARDXC via RA DX 25/12)

URUGUAY R. SODRE International Service transmits 15-min EG nx at 2200, 2330, 0100, 0230 on 11885/9515 (BBCMS 22/12) Subject to considerable variation (gh)

TURKEY From 1/1, VOT moved EG to Nam to 2130-2300 on 9515, to Eu on 7170. Also new EG to SWAs 1200-1300 on 9665 (David Kernick, UK) 7170 ex-7175. The time change is welcome because at their old time of 2200-2430, BBC-9510 obliterated VOT after 2300 (John Barnett, NC) The new sked applies every day but Fri, when still 2200-0030 (M. J. Collins, WDXC Contact) Turkish noted past 2200 on 9515, with EG on 7170 only (Edwin Southwell, WDXC Contact, Jan.)

TANZANIA ES of R. Tanzania, all EG except Afrikaans and vernaculars in some cland pgms. 0330-0500 & 1530-1915 to E&C&Saf 15435/6105. 0900-1030 (Sat/Sun-1530) Eaf on 9750 (R. Tanzania via BBCMS 1/78) See PROGRAM NEWS for more details, LN-12; CLANDESTINE CRANNY, LN-10

SWEDEN R. Sweden made a further mid-season change, as of 19/1 EG at 0230 to Nam on 11850 ex-11705 (SCDX 17/1 via gh)

SWAZILAND Swazi Commercial Radio reorganized services 28/11. **Radio SR** is now in EG 0200-0500 & 1530-1730; Sat 0400-0800 & 1600-2200; Sun 0600-0800 & 1600-1900. R. Truro is in EG with Indian langs weekends: Mon-Fri 1100-1530; Sat 0400-1600; Sun 0800-1100 & 1400-1600. The Jewish Sound, in EG is Sun 1900-2000. Freq sked: 3223 at 0200-0400; 4980 0400-0600 & 1730 to close-down; 6155 0600-1830 (Richard Ginbey, RSA, SCDX 20/12) Both SCR and TWR have vacated 90m for local eve pgms. SCR noted on 4980 in 1900-2100 period, entirely EG, QRMing Ghana 13/1. TWR obs on 5055, EG religious 2000-2036* 13/1 (Bob Padula, Victoria)

SOUTH AFRICA SABC Domestic SW Services, D77: R. South Africa: 0358 (Sat 0430, Sun 0500)-0635 on 4835; 0635-1520 11790; 1520-close down on 4835, all to SW Africa. 0358 (Sat 0430, Sun 0500)-0520 on 3965; 0520-1620 on 9680; 1620-close down on 3965, all to NW Cape. **Springbok Radio** (mixed EG and Afrikaans) 0300 (Sun 0400)-0637 on 4810; 0627-1522 11935; 1522-2200 on 4810, all to SW Africa. 0300 (Sun 0400)-0522 on 3980; 0522-1622 on 9710; 1622-2200 on 3980, all to NW Cape. R. South Africa-All Night Service 2200-0300 (Sun 0400) on 3250 & 3980. **Market Reports & Meat Prices** (evidently mixed EG & Afrikaans) Mon-Fri 1605-1650 3250. **Radio 5 EG & Afrikaans** 0300-0530 3320; 0530-1530 7170; 1530-2200 3320 (via Sam Barto, CT)

- 6155 AUSTRIA ORP: 0055 GM followed by FR(Cliff). 0137-0158 EG Feature(Earhart). 0212 GM talk on Austrian Economy(Leffler). 0353 EG, "How to cook Fish" (Dunn).
- 6155 PORTUGAL Rdf. Portuguesa: IS, time pips, PT talk and mx(Zilmer).
- 6155 U.S.A. WYFR: *0100-0244 EG, "Conference Echoes", bible readings, ID (McCants).
- 6160 HUNGARY R. Budapest: *0130-0214 HG & EG, mx on Hungarian economy, dramatic reading M&W w/commentary on Hungary, Belgrade conference(Berezowski, Brown, Zilmer, Leffler).
- 6160 GRAT BRITAIN BBC: 2200 world news, EG(Zilmer).
- 6160 CANADA (Newfoundland) CKZN: 1000 EG local news, wx, sports(Taylor). 1615 nx, pgn previews, talk by a W on fish for the holidays (Desrosiers 12/14).
- 6160 PHILIPPINES VOA: *1258 ID in EG, into possible CH @ 1300 (Jones-MS).
- 6160 COLOMBIA Emis Nueva Granada: 0910 SP amts, ads & LA mx (Tannenwald).
- 6165 HUNGARY RB: *2330 HG, IS 2325-2330, mx (Zilmer).
- 6165 NETH ANTILLES (Bonaire) RN: 0030-0045 DT nx & cmtry (McCants). 0230-0320 EG nx, DK jukebox, xmtry, IS&ID (McKinney, McCants, Welch, Sandborn, Miller) 0530-0620 EG "Focus", "Studio-6", "Letterbox"(Swanson, McKinney).
- 6165 MEXICO LV de Amer Latina: SP freqs, pop mx (Jones-MS).
- 6168 CANADA BBC via Sackville terribly mistuned, but missing on 5990 11/12 at 1320; had FM warble on carrier during "Letter from America". At 1329 closing referred listeners to 9580 later, as Sackville usually does on 5990. Also, audio was characteristic of Sackville, i.e. trans-Atlantic cable feed, rather than SW relay off air as is customary with Antigua, which continued as usual on 6195 (Hauser-TN).
- 6170t MONSTERRAT BBC: EG world news, strongest station on the band!, perhaps a test from Monsterrat or Antigua relay station. 500kHz? (Zilmer). -time was 1300 -sw
- 6175 ANTIGUA BBC: EG 2330-0730 "Country Music British Style", top 20, radio theater, "Radio Newareel", "Pinal Checkup", EG nx and cmtry (McKinney, McCants, E. Miller).
- 6180 CYPRUS BBC: EG world news at 2315, ID, gave xmtr site (Zilmer).
- 6180 GUATEMALA R. Nacional: 1150 SP Marimba band mx, ID (Tannenwald).
- 6190 CHILE CE619, RN de Chile: Heard 1/5 with a special election program in SP. 0408 M in SP w/speech. Traffic noises and crowd cheers. //9530, 11705, 15148. program ended at 0415. 0417 "La voz de Chile" theme song, gong, then s/off. (Hywarren).
- 6195 CANADA CEC-NS: 0220-0600 EG, eskimo and FR programs, EG rpx mx, and nx. Eskimo country mx. (Leffler, Swanson, Desrosiers).
- 6195 WEST GERMANY VOA-Munchen: 2130-2205 in Lang., ID's clearly hrd 2200 (Desrosiers).
- 6195 ANTIGUA BBC: *2000 s/on w/EG world news (Prath).
- 6200 UNID M in FR 2015, AR mx o/Radio Moscow IS heard 2030. (Kukan).
- 6200 ALBANIA R. Tirana: ID, nx by M in EG, commentary and NA (Plotnick-CT, Welch).
- Please make sure your strips of paper are not less than 3/8 inches and not more than 1 inch. This way I will be able to sort the frequencies easier. NASWA rpt forms are IDEAL! Please excuse all the mistakes I made this month but we had a very early deadline. Next month shows no sign of improvement as an early deadline exists also. However, April and beyond I will have more time to improve my typing skills in doing this column. So please be patient (at least through the March issue).

SCADS TO MEET: The Southern California Area DXers (SCADS) will meet on February 11, 1978 at the Valley View School Auditorium, 5361 Sisson Drive, Huntington Beach, CA. Doors open at 8:00 AM with the meeting being from 10:00 AM to 5:00PM. Voluntary donation of \$1.00 to help cover expenses. For additional information, contact Donald Erickson, 6059 Essex Street, Riverside, CA 92504 (SASE appreciated), or for last minute call 714/687-5910 anytime through February 10, 1978. All NASWA members invited.

HELPING HAND: For sale. Barlow-Wadley XCR-30 Mark II receiver with accessories. \$220.00 including shipping. Also, Gilfer A-20 Preselector, 3.2 - 18 MHz version, \$42.00 including shipping. Both in mint condition. Contact Andrew Pappas, 11421 S. Maplewood Avenue, Chicago, IL 60655.

HELPING HAND: For sale. Heathkit HW-8 QRP CW transceiver and power supply. Almost new, \$125.00 plus shipping. Must sell to pay for new FRG-7. Contact Gerald Word, 801 Rome Street, Carrollton, GA 30117.

HELPING HAND: For sale. SX-190 receiver with speaker in good condition. \$170.00 or best offer, plus shipping. Operating and technical manuals included. Contact Solomon Wilson, 8048 Rodney Street, Philadelphia, PA 19150 or call 215/CA4-5382.

HELPING HAND: For sale. Gilfer C-10 Calibrator, mint condition. Just \$35.00. Contact J. Huniwell, 188 Chestnut Drive, Barneget, NJ 08005.

Ed. Sec-C: log report

6205 kHz to 11700 kHz
FEBRUARY, 1978

section



Tom Gavaras 16920 17th Ave. N. Wayzata, MN 55391

ALL REPORTS FOR THE LOG REPORT SECTIONS SHOULD BE SENT TO OUR DISTRIBUTION EDITOR: GRBG: RAVENHORST, RURAL ROUTE, HOLLANDALE, MINNESOTA 56045! HIS DEADLINE IS THE 12th OF THE MONTH!

- 6205 LIBYAN WATERS Mebo II; 2031 Continuous pop and rock music with talk by man in English stating that this is a test transmission. Very poor but still around. (Osterman 12/23). -Now listed on the air from 1800-2100* (editor)-
- 6213 HOLLAND (PIRATE) Free Radio Broadcasting Co; 0912-1030 English with British DJ, TC, IDs, pop music. Special program. Gave address as Box 41, Dedemsvaart, Holland. Listed 6 KW. Good signal! (Robinson 1/1). -Thanks for the call Dan! I hope I got everything correct. Fantastic Catch!!!! (Editor)-
- 6225 CHINA R. Peking; 1435 unidentified lang (Chinese?) with talk by OM. Poor (Hywarren).
- 6230nf EGYPT R. Cairo; 0200-0315 English ID, News, cntry, Mailbag, etc. // 9475. (Lefler, Sandborn, Sapoznikow, Desrosiers, MacKay, Petravick, Utter, Delap).
- 6232 MEDITERRANEAN WATERS Voice of Peace; 0100 Lang with pop music w/some English records. At 0115 a YL gave news. Poor audio quality. (Zilmer 12/23). -This is the first report I have seen of this stations shortwave transmitter. Congratulations Bob!!! Did you hear anything resembling an ID? (Editor)-
- 6235nf PAKISTAN R. Pakistan; 2100-2145* Urdu & lang w/talk & native music. National Anthem and off. (Osterman 1/3, Utter 12/31, C. Sherman 12/31).
- 6250 KOREA (NORTH) R. Pyongyang; 2213 Korean talk by OM & YL. Poor w/CW QRM. No sign of Equatorial Guinea. (Hywarren 12/25).
- 6270 CHINA R. Peking; *2130+ Language with talk by YL (Hywarren 12/29, Utter 12/31).
- 6290 KOREA (NORTH) KCBS; 2148 Korean into March music & play. Good (Hywarren 12/29).
- 6340t TURKEY Turkish Police Radio; 1535-1606 fade in w/many Turkish announcements by man. The announcer would talk for about 1-2 minutes, then play a short section from an orchestral LP. He'd lift up the needle, make an announcement, and then continue playing the same LP! No ID, but w/freq and with language so positively Turkish, I have no doubts. Good signal at times, but f/out by 1606. (Sarrasin 12/27) Great Catch!
- 6345 CHINA R. Peking; 0932 Chinese 2nd pgm w/play & piano mx (Brookwell). 1230 lang w/choral mx & tlk/5163 (Zilmer). 1433 lang w/revolutionary play (Hywarren).
- 6410 CHINA R. Peking; 2330 Chinese talk by man & woman (Prath 12/30).
- 6540 KOREA (NORTH) R. Pyongyang; 1324 Japanese program with Korean music (Yajko 1/1).
- 6550 LEBANON V. of Lebanon; Reported to have increased power, and this is the prime season to hear it in NAM, if ever. Checked 12/10 at 2125, and heard very weak music with beat; exalted carrier helped; armt at 2158 and different music—anthem? Stayed on past 2200, it seemed. Trouble is, VOL normally closes at 2100. In any event, this was certainly not R. Peking which has EG on this frequency. Maybe a 5 x 1310 harmonic? (Hauser).
- 6560 CHINA R. Peking; 1353 Russian talk, ID, IS. (Brookwell 12/31).
- 6600 KOREA (NORTH) KCBS; 2250 Korean talk by YL into Childrens choir vocal (Hywarren).
- 6675 SPY STATION; Same as the one reported by Berg and others on 4740; hrd 1/3 at 2313 to 2320* playing opening of triumphal march from Aida over and over. Didn't give any Slavic numbers (Hauser).
- 6683,5 CHILE R. Nacional de Chile; 0439 Spanish relay of R. Nacional pgm on suppressed carrier, 4 note chime IS. (Brookwell 12/22-23).
- 6750 CHINA R. Peking; 1143 Chinese HS w/tlk & mx (Strawman). 1200 lang w/IS & tlk (Zilmer) 2155 lang tlk & Chinese type mx (Hutchins). 2253 Chinese(?) talk. Poor sig. (Hywarren)
- 6770 KOREA (NORTH) R. Pyongyang; 1330 Korean talk w/Choral music (Yajko 1/1).
- 6955 CHINA R. Peking; 1145 Korean talk (Strawman). 1358 lang w/high pitch vocal (Florian).
- 7035 CHINA R. Peking; 1146 Chinese talk. Fair signal (Strawman 1/2).
- 7055a UNIDENTIFIED; 0632 French talk w/Louis Armstrong Jazz. Loud Buzzing Het (Blaise 12/3).
- 7065 ALBANIA R. Tirana; *0000-0025* English mx, cntry, etc. (McCants, Prath, Fraser).
- 7085 CAMBODIESTINE R. Abdala; Heard 12/25 from 2337 with "Ave Maria" music every few minutes and anti-Soviet, anti-Castro propaganda. At 2348 played theme to "2001: A Space Odyssey" and off. Was torn to pieces by CW hams. Checked a week later and couldn't hear it. However, when I arrived at San Juan airport, a guy from the Agrupacion Abdala was handing out handbills discouraging travel to Cuba. He said the transmitter was in Florida, and that they hoped to put another one on from Central America. (Hauser). -Any idea as to where in Central America? Fantastic Glenn!!! (Editor)-
- 7100 USSR R. Moscow; 0045 English Press Review w/talk about Trade (Prath 12/4).
- 7105 MONACO TWR; 0736-0829+ English Religious programs (Hansen 12/31, Tiers 12/5).

- 7110 MALI Rdf National du Mali; 0802 FR ID "ici Bamako," military mx (Dunn 1/1).
- 7110 USSR R. Moscow; 0130 English news, cmntry about "Wilmington 10", etc. (Pearson).
- 7115 USSR R. Moscow; 0300 English s/on w/IS, ID into news program (Gallagher 12/30).
- 7115 BULGARIA R. Sofia; 0430 IS, EG ID, sked, etc. (Zilmer). 2140 EG News, ID (Clark).
- 7120 ALBANIA R. Peking Relay; 0100 EG pgm (Hlossom, Fraser). 0200 SP ID, etc. (Yacono).
- 7125nf MONACO TWR; 0800 English Radio Bible Class (Dunn 1/1).
- 7150 USSR R. Kiev; *0030-0100* EG news, etc. (Fraser, McKinney, Earhart, Fick).
- 7150 USSR R. Vilnius; *2300-2328* English nx, cmntry, folk mx, etc. (Burke).
- 7160 GERMANY (WEST) DW; *1720-1750* English news, commentary, music (C. Sherman 12/28).
- 7170 GREECE VOA (Kavala); 0200 Urdu w/IS, ID, News by OM (Kukan 12/18).
- 7170 SOUTH AFRICA SABC; 0854 French late hits w/DJ pgm. Weak but clear (Brookwell 12/28).
- 7170nf TURKEY VOT; *2130-2300* EG news & cmntry. NF- not on 71751 (C. Sherman 1/7).
- 7170 USSR R. Moscow; 0405 English cmntry about USSR's Continued Quest for Peace (Bohlke).
- 7175 TURKEY VOT; 2239 EG w/mailbag, ID, etc. (Sillings). 0420 Turkish talk w/string rx (Earhart). 2045 Turkish(?) talk and music//9515 (Cress). -also see 7170kHz (editor)-
- 7175 USSR R. Moscow; 0446 English with commentary about the Right to Work (Johnson 12/20)
- 7190 USSR R. Moscow; 0025 EG "Thinking Out Loud" pgm (Prath). 0331 EG cmntry, tlk (Elaize)
- 7200v USSR R. Moscow; 0000-0220 EG Nx, cmntry, etc. (Rend, Fick, Fraser, Prath).
- 7200 ENGLAND VOA; 0435 English with the Breakfast Show (Florian 12/30).
- 7205 USSR HS pgm; 0550-0601 Russian with electronic music (Desrosiers 12/8).
- 7225 PHILIPPINES FEBC; 1110-1130* English religious pgm, ID, etc. (Kukan, Burke).
- 7225 RWANDA DW; 0413 lang w/talk about India, ID (Bogel)-I have Swahili listed as lang(ed)
- 7245 ANGOLA R. Nacional; 0655-0710 Portugese talk w/local piano music (Alexander 1/1).
- 7265 GERMANY (WEST) Sudwestfunk; 0203 German news, US pop music. Good sig. (Sarrasin).
- 7270 ASCENSION ISLAND BBC; 0530 EG James Morgan comments on "Postboy Africa" (Elaize).
- 7270 POLAND Polish R; *0200 EG talk about Carter's visit to Poland (Cohen, Fraser, Altman, Yajko). 0640 English ID, mx, answers to listeners questions (Alexander).
- 7270 SOUTH AFRICA RSA; *0256 English ID, nx. Announced reduced power on 7270 due to transmitter difficulties (Welch 12/16, Gallagher 12/30).
- 7275 CYPRUS BBC; 0610 English w/British news, cmntry on Fireman's Strike (Elaize 12/10).
- 7275 NIGERIA VON; 0555-0613* EG ID, news, cmntry, etc. (Poppin, Sandborn, Burke).
- 7280 LIBERIA VOA; 0453-0527* ID in EG, Breakfast Show, mx, etc. (Berezowski, Bryan).
- 7285 MADAGASCAR R. Nederland; 2125 IS, Indonesian ID, nx. Fair signal (Hywarren-UMDX).
- 7290 ALBANIA R. Tirana; 0430 IS, s/on, Arabic ID, News. HAM QRM (Florian 12/30).
- 7300 USSR R. Moscow; 2138-2150 English news & Africa mailbag (Earhart 12/25).
- 7320 ENGLAND BBC; 0000-0453 English news, Talk about Britain, etc. (Reno, Kukan, Earhart).
- 7335 CANADA CHU Time Station; 1427-1525* EG/FR Time arnts, pips (Berezowski, Desrosiers).
- 7340 USSR R. Moscow; 1832 Italian news with QRM from CHU (Hermann 12/18).
- 7345 CZECHOSLOVAKIA R. Prague; 0100 EG pgm (Pearson, Fraser, Kukan). 0330 EG pgm (Prath).
- 7360 USSR R. Kiev; 0310 EG cmntry (Prath). *1800 ID & News in German (Hywarren, Hermann).
- 7360v USSR R. Vilnius; 2310 English news about famous Lithuanians, etc. (Plotnick 12/27).
- 7375 VIETNAM VOV (Hanoi); 0833 Talk by man & woman, music. Bad Het! (Brookwell 12/12).
- 7390 USSR R. Vilnius; 2315 English talk about Lithuania by YL (Prath 12/23).
- 7412 ISRAEL IBA; 0506 EG News & Press Review (Tiers). 2230 English wrld nx (Prath).
On 12/24 IBA had special service from Church of Nativity in Bethlehem with a nice organ concert until 2330, closing with EG & FR arnts//9815, but not on 9435. Cf my earlier report about audio differences on IBA frequencies; I now understand this is due to individual audio processing at each of the four transmitters, not because of a secret IBA relay base in some other country, hi (Hauser).
- 7417 VIETNAM VOV (Hanoi); 0016 Vietnamese talk w/songs sung by a female (Brookwell 12/25).
- 7465 ISRAEL IBA; 0430 Hebrew talk and music to 0500 news (Brookwell 12/18).
- 7470 VIETNAM VOV (Hanoi); 0026 Indonesian talk & oriental mx (Brookwell 12/25) -I have Vietnamese listed here! (Editor)-
- 7490 USSR Unid; 1225 Russian TC. Piano mx, cmntry, vocal mx; "It Pleases me" (Poppin).
- 7504 CHINA R. Peking; 1150 Chinese talk (Yajko). 2129 Chinese(?) mx & vocals (Hywarren).
- 7512 VIETNAM VOV (Tay Nguyen); 1152 Vietnamese music & talk (Yajko 12/12).
- 7590 CHINA R. Peking; 2132 English ID into News. Fair signal (Hywarren).
- 7600 ECUADOR HD210A Time Station; 0453 Time pips & Spanish time announcements (Tiers).
- 7620 CHINA R. Peking; 0908 Chinese 2nd pgm (Brookwell). 2133 talk in lang (Hywarren).
- 7651 USA VOA (Greenville); Yes, this is here 0630 EG w/xmas mx on SSB1 (Sarrasin 12/25).
- 7780 CHINA R. Peking; 2026 German political talk by OM. Fair sig. (Hywarren 12/28).
- 7991 ENGLAND BBC; 0020 Spanish feeder on RCSSB with news program (Hauser-PR 1/4).
- 8000 JAPAN JQ2AE Time Station; Second & minute pulses w/ID at 0059 (Brookwell 12/25).
- 9009 ISRAEL IBA; 1611 w/IS. Good (Hywarren) -language? (ed)- 2030 FR ID & nx (Fraser).
- 9020 CHINA R. Peking; 0904 Chinese talk and nice music (Kukan 12/17).
- 9065 CHINA R. Peking; 1151 Chinese talk & music. Poor-fair (Straman 1/2).
- 9022 IRAN VOI; 1930* English ID, nx, cmntry, mx, etc. (Sandborn, Sapoznikov, Hutchins).
- 9022 KOREA (NORTH) R. Pyongyang; 1216 Chinese talk, classical & chorus mx. Not listed in BBC-MS but heard several days (Brookwell 12/27).

- 9115.0 ARGENTINA; Pitt McNeil called me 11/22 at 0250, so I tuned in to try to ID it. Was playing music at 0258 on full AM, 0301 vibraphone IS and "R. Rivadavia" ID, news, mentioning AM & FM. Is listed on MW only, 630 kHz. Went off at 0316; SIO:2h2(Hauser)
- 9290 CHINA R. Peking; 0019 Sing Song lang w/talk, Squeaky violin, EIR, etc. (Brookwell).
- 9350 ISRAEL IBA; 2300 Hebrew talk with pop music (Zilmer 11/20).
- 9365 CHINA R. Peking; 0035 talk in language with Oriental music. Strong (Brookwell).
- 9365t USSR R. Pacific Ocean; 1900 Russian news with R. Pac. Ocean IS (Brookwell 12/8).
- 9410 ENGLAND BBC; 1909 EG w/soul mx (Bryan). 23L5 EG Matthew on Music (Swanson).
- 9420 KOREA (NORTH) R. Pyongyang; 1321 Spanish tlk & mx (Strawman). 1802 FR pgm (Brookwell)
- 9435 ISRAEL IBA; 2230 English w/IS, ID, News, Talk on Sadat, etc. (Hoffmann, Hauser).
- 9455 EGYPT R. Cairo; 0621 Arabic chanting, talk, Arab mx//7075 (Hlaize 12/3).
- 9460 CHINA R. Peking; 0300 Chinese lang lesson in English. Strong signal (Watson).
- 9465 PAKISTAN R. Pakistan; 2100 English speech to crowd & His Excellency of Pak.(Sarrazin)
- 9475 EGYPT R. Cairo; 0200+ English ID, News, Arabic mx, etc. (Reno,Welch,Bohlke,Prath). 1915 Arabic tlk & mx (Bryan). 22L7 Arabic interview, music, etc. (Poppin).
- 9480 ALBANIA R. Tirana; 2225 English Identification into s/off (Poppin 12/16).
- 9500v LIBYA PRB; 0030-0058* Arabic mx & talk about Sadat (Gallagher, Earhart).
- 9505 PERU R. America; 1042 Spanish Identification, music & talk (Zilmer 11/20).
- 9505 SPAIN RTVE; *2200 English commentary on woman's rights (Zilmer 11/23).
- 9505nf SWEDEN R. Sweden; *0030 English news, cmntry, panorama, etc. (C.Sherman,Zilmer).
- 9510 TAIWAN WOF; 1300 Chinese Identification, talk and music (Yajko 1/1).
- 9515 TURKEY VOT; 2103 Turkish nx (Leffler). 2202* English News, cmntry, mailbag, mx, etc. (Innat,Reno,Bogel,Desrosiers,Berezowski,Hoffmann). VOT has shortened and retimed its English to 2130-2300. Noted 1/5 at 2237 with DX Corner. I think they said it had been cut to only two times a week now, but reception was awful. (Hauser).
- 9515 URUGUAY SODRE; 0040-0235 English and Spanish talk with ID, cmntry, soft music, etc. (Sandborn,Gallagher,Innat,Tiers,Cannon,MacKay,Fraser,Yajko).
- 9515 UNIDENTIFIED; 0356 IS, tinkling quality, unid language under VOT. Help! (Brown 1/8).
- 9518 PERU R. La Cronica; 1045 IS, Spanish ID, Peruvian style mx, tlk (Zilmer 11/25).
- 9520 PAPUA NEW GUINEA NBC; 0735 English talk w/rock mx. Cllobbered by RTVE 0750 (Brookwell)
- 9520 SPAIN RTVE; 0827 Spanish w/ID, Pop music, etc. (MacKay 1/1).
- 9525 CUBA RHC; 0200 EG w/P.O. Box 7026 pgm (Swanson). 0735 EG w/Local mx (Gallagher).
- 9525 INDIA AIR; 1830 English with lengthy excerpts of President Carter addressing Indian parliament 1/2. (Hauser-FR). 2000-2226 English News, cmntry, interviews, mx, etc. (Taylor, Bishop, UMDX, Poppin).
- 9525 POLAND Polish Radio; 1630 English news & cmntry w/talk about Ethiopia & Somalia
- 9525 USA WYFR; 0035-0051* German religious talk, mx, ID. Fair. (Bogel). (Sapoznikov).
- 9530 BULGARIA R. Sofia; 2158 English music and ID by a woman (Valko 1/2).
- 9530 CANADA RCI; 2107 English news & music with heavy QRM (Leffler 1/2).
- 9530 GREECE VOG; 1930 English talk by YL, International news into French pgm (Cohen).
- 9530 JORDAN HKBS; 1925 English news into French pgm at 1930 (Yajko 12/26).
- 9530 ROMANIA R. Bucharest; 1500 English news and commentary (Dunn 12/26).
- 9535 CANADA RCI; 0100 EG News (McCants). 0215 EG Pop pgm (Prath). 0312 EG tlk (Hlaize).
- 9535 SWITZERLAND SBC; 1815 IS, Italian Service w/talk about Cairo Cnference(Desrosiers).
- 9540 AUSTRALIA R. Australia (Shepparton); 1020 English nx, cmntry, Countdown pgm(Miller).
- 9540 CYPRUS BBC; 1215 English cmntry and news (Valko 12/7).
- 9540 USSR R. Tashkent; 1206-1226 English news and music (Valko, Prath).
- 9540 NORWAY R. Norway; 0000 English w/Norway This Week, News & Views (Zilmer 1/1).
- 9555 PHILIPPINES VOA (Tinang); 1250 English Lessons, etc. Fair. (Strawman 1/2).
- 9555 USA KGEI; 0109 Spanish with music, religious announcements, etc. (McCants 1/8).
- 9560 AUSTRALIA R. Australia (Carnarvon); 2155 Indonesian service w/rock mx (Utter 1/2).
- 9560 ECUADOR HCJB; 0055-0337 English w/Passport, Unshackled, DX Party Line, etc. (Fraser,McCants,Sandborn,Valko,Bryan).
- 9560 JORDAN HKBS; 1640-1730* English nx, cmntry, weather, etc. (Alexander, MacKay).
- 9565 USA VOA (Delano); 1530 English. Ben Grauer lived on via reruns some 6 months past his death as host of VOA's "New York, New York". Checked 12/17 to find that Arlene Francis has taken over the program. Good job. VOA seems to prefer personalities who were once well-known on domestic radio/TV but have been out of the scene recently, cf. Garry Moore who preceded Grauer. (Hauser).
- 9565v CHILE V. of Free Chile; 0210-0230 English talk abt rights in Chile (Miller,Swanson)
- 9570 QATAR QBS; 1320 Arabic chants and stringed music (Osterman 12/11).
- 9570 UNIDENTIFIED; 1309-1331 Arabic mx w/male announcer. (McCarthy). -See above (editor)-
- 9572 CHILE R. Diego Portales; 0113 Spanish ID, talk, comedy play, etc. (Cannon).
- 9575 ITALY RAI; 2350 Italian talk by M&W (Prath). *1000 EG News, mx (Reno). I guess RAI xmtr engineers don't pay attention which audio feed goes into which xmtr; anyhow, on 12/28 at 0101 this was in Spanish//9710 instead of sked English, but 6010 was English. See 11905 (Hauser).
- 9579m PHILIPPINES VOF; 0938 English w/OM & US pop music, IDs, etc. (Kukan 12/11).
- 9580 AUSTRALIA R. Australia; *1100-1300* EG News, cmntry, pop mx (Prath, Fraser).
- 9585 HUNGARY R. Budapest; 0200 English news //6160 (Zilmer 12/26).

- 9585 SOMALIA R. Mogadishu; 1830-2000 Arabic & Somali pgm of nx, cmntry, mx (McCarthy).
- 9585 SOUTH AFRICA RSA; 2130 English w/DK Corner (Ihmat). 2230-2320 EG ID, nx, cmntry, etc. (Kukan, Fraser, Hoffmann, Prath, Swanson). 0048-0110* English with Special New Years Call-in program. Gave phone number as 7140068. (Sillings, Bohlke, Gavaras). -I hope they do another call-in type pgm in the near future! (editor). 0349 English news about South African Animal Conservation (Bryan).
- 9590 NETHERLAND ANTILLES R. Nederland; 0230 EG pgm (Reno, Pearson). 0403 SP ID (Desrosiers).
- 9590 NORWAY R. Norway; 0050 Norwegian nx & ID (Tiers). 0200 EG Norway this Week (Zilmer).
- 9590 PHILIPPINES R. Veritas; 1400-1500 English ID, address, Flashback 77 pgm, DX pgm. (Yajko 1/2, Florian 12/29, Vargo 1/1).
- 9590 SRI LANKA SLEBC; 1330 EG ID, music into Sinhaza pgm. (Osterman 12/21).
- 9595 ECUADOR HCJB; 0202 French talk w/Ecuadorian mx then Religious talk (Earhart 12/15).
- 9595 JAPAN NSB; 1603 English with Tokyo Forum program (Grenier 12/31).
- 9600 ASCENSION ISLAND BBC; 0511 English news about Rhodesia (Bryan 12/23).
- 9600 USSR R. Tashkent; 1200 EG News, etc. (Miller, Dubin). 1417 EG tlk & mx (Florian).
- 9605 CZECHOSLOVAKIA R. Prague; 1428 English commentary (Tiers 12/4).
- 9605 JAPAN R. Japan; 1930 IS, Russian ID & talk. s/off in English (Bryan 12/25).
- 9605 NORWAY R. Norway; 1400 English with Norway This Week (Zilmer 12/25).
- 9605nf SWEDEN R. Sweden; 2300 English news, panorama, SCDX, etc. (Zilmer 12/6).
- 9605 VATICAN STATE Vatican Radio; 0030 SP w/ID, religious nx (Gallagher). 0100 English ID, Religious news, etc. (Valko, Berzowski, Sandborn, Kerr).
- 9610 AUSTRALIA ABC (Perth); 1127-1528 EG ID, nx, etc (Earhart, Reno, Hascall, Sandborn, Bunce)
- 9615 MOROCCO RTVM; 2156* Arabic music, ID, news, etc. (Valko 12/1, Zilmer 11/24).
- 9615 VATICAN STATE Vatican Radio; 2215 English with Religious news (Zilmer 11/24).
- 9620a USSR R. Moscow; *1130 English nx, cmntry, The Young Generation pgm (Miller 12/26).
- 9625 CANADA CBCNS; 0005 EG w/As it Happens (Swanson). 1300 Cree Indian & EG tlk w/pop mx (Fraser). 1640 EG Remember BBC's "Listening Post," telling us what other stations were saying? Now there's something like it, but much less serious, each Monday. (Hauser). 2345 English with Perspectives (Swanson).
- 9625 USSR R. Moscow; 1005 German news and commentary (Prath 12/18).
- 9630 SPAIN RTVE; 0401 Spanish w/time pips, ID and news (Bryan 12/28).
- 9630 SWEDEN R. Sweden; *1100 English news, cmntry, Press Editorial (Miller 12/28).
- 9630 USA WYFR (Florida); *2100-2230 IS, EG ID, Religious pgm (Zilmer, Alexander, Cannon).
- 9635 IRAQ R. Baghdad; 1935 EG cmntry, pop mx into German at 2030 (Osterman, Dubin).
- 9640 GUAM TMR; 1046 English w/Religious music & talk. (Kukan 12/11).
- 9640 KOREA (SOUTH) R. Korea; *1600 EG ID (Desrosiers). *2300-2330* EG ID, nx (Bishop).
- 9645 COSTA RICA TIPC; 1200 Spanish religious talk, organ music & ID (Valko 12/20).
- 9650 AUSTRIA ORF; 0158 IS into German program (Petravick 1/3).
- 9650 GERMANY (WEST) DW; *0930 English news about Soviet Union & West Germany (Miller).
- 9650 MOROCCO VOA; 0340 English w/review of top songs of 1977 (Bohlke 1/3).
- 9650 SEYCHELLES FEBC; *0314 English w/IS, cmntry about S. Africa, etc. (Earhart 12/26).
- 9650t TUNISIA R. Tunis; 1920 Arabic w/monotone cmntry, IDs not readable (Desrosiers).
- 9655 COLOMBIA R. Nacional; 0150 SP Classical mx & ID (Alexander). 0420 SP w/march mx (Brown). 1159 SP ID & Classical mx (Strawman). 1610 SP tlk, ID, old US pop mx (Delap).
- 9655 MALTA DW; 1645 German ID, News, etc. Poor signal (Hermann 12/12).
- 9660 VENEZUELA R. Rumbos; 0257-0344 SP nx, talk, ID (Valko, Hascall). 1210 SP pgm (Prath).
- 9665 BRAZIL R. Nacional Brasilia; 1022 Portuguese w/IDs, ads, announcements (Yajko 12/27)
- 9665 KOREA (SOUTH) R. Korea; *1430 English news program (Zilmer 11/26).
- 9665 MALAYSIA R. Malaysia; 1512 talk in lang by OM & YL (Strawman 1/2).
- 9665 SWEDEN R. Sweden; 1400 English news & talk about unemployment (Woltman, Tiers).
- 9670 AUSTRALIA R. Australia (Shepparton); 1200 English ID, News, etc. (Alexander, Burke).
- 9675 BRAZIL R. Diario da Manha; 2230 Portuguese w/A Voz do Brasil Relay. Fair (UMDX).
- 9675 PERU R. del Pacifico; 1100 Spanish Identification, Religious pgm (Zilmer 11/25).
- 9680 SOUTH AFRICA SABC; 0520 English report from Tel Aviv, xmas carols (Mackay 12/12).
- 9680 USSR MAYAK; 1945 Russian news, music, Moscow Nights, pips, IS, etc. (Hermann).
- 9685 ALGERIA RTVA; 2055 Arabic ID followed by Arabic mx (Yacono 12/2).
- 9685 BRAZIL R. Gazeta; 2220 Portuguese w/Footbal Brasilia vs Corinthians. Good (UMDX).
- 9685 CUBA RHC; 0100 EG (Reno, Valko, Bohlke). 0432+ EG nx, etc (Tiers, Burke).
- 9690 ARGENTINA RAE; 2325 EG nx (Swanson). 0200 SP pgm (Miller). 0305 EG pgm (Plotnick, Yacono).
- 9690 USSR R. S. Atlantika; 1637 Russian tlk, mx, IS, etc. (Hermann).
- 9695 BRAZIL R. Rio Mar; 0000 Portuguese TC, ID, Guitar music. Very good signal (Bishop).
- 9700 SWITZERLAND SBC; *0145 English w/Dateline/9725 (Alexander 1/3).
- 9705 BRAZIL R. Ipanema; 0107 Portuguese w/Footbol, odd ID. Fair (UMDX 12/11).
- 9710 SOUTH AFRICA Springbok Radio; 0540 EG/AK w/pop tunes, ads, ID (Mackay 1/8).
- 9715 HOLLAND R. Nederland; 2200-2220* English conversation w/Scotch editors (Reno 1/2).
- 9715 NETHERLAND ANTILLES R. Nederland; 0530 IS, EG ID, World Nx, etc. (Blaise 12/10).
- 9720 USSR R.S. Atlantika; 1627 Russian talk, IS and R.S. Atlantika ID (Hermann 12/18)
- 9725 BURMA BBS; 0659 tune in w/end of mx interlude. OM ID at 0700 "This is Burma, the Burma Broadcasting Service..." into nx. 0709 nx ends, ID into a mx pgm entitled "music". Fair signal. Now for the QSL. (Hywarren 12/16). -Nice catch, Aaron(ed)-

- 9725 SWITZERLAND SBC; 0145-0200 English news, Dateline, etc. (Welch, Woltman, Reno).
- 9725 USSR R. Moscow; 1100 English news and music (Woltman 12/25).
- 9730 GERMANY (EAST) RBI; 0145* EG pgm (Berezowski). 0302 EG mx, nx, cmntry (McCants).
- 9730 UGANDA UBC; 2030-2100* EG ID, nx, xmas mx (Desrosiers, Hywarren, Sandborn, Vargo).
- 9735 GERMANY (WEST) DW; 0340 German ID (Bogel) - I have Malta listed here (ed) - (Gavaras).
- 9740 GREECE VOA (Kavala); 0408 English w/world nx, etc. (Bryan 12/28).
- 9740 PORTUGAL R. Portugal; 2120 Spanish mx, ID to Latin America (Tannenwald 12/18).
- 9745 CAMEROON R. Yaounde; 0610 EG ID, nx, sports, etc. (Poppin, Dunn). 1945 French cmntry about Arabic mx & ther. played some Arabic music. (Burke 12/8).
- 9745 IRAQ R. Baghdad; 1720-1920 Arabic ID, nx, etc. (Fraser, Desrosiers). *1930-2030* EG nx, cmntry (Fraser, Burke, Berezowski, Dunn). 2210-2230* EG pgm, nx (Delap).
- 9750 ALBANIA R. Tirana; 0000 EG ID, news, cmntry (Yacono, Miller, Swanson).
- 9750 CHILE R. Minería; 0945 SP news, TC, xmas mx, etc. (Miller 11/26).
- 9750 GREECE VOG; *0215 IS, EG Identification, news, Greek mx (Miller 11/24).
- 9750 TANZANIA R. Tanzania; 1510 EG cmntry by man on Tanzania's roll in Africa, ID (Onken).
- 9765 ASCENSION ISLAND BBC; 0030 Identification in Spanish, tlk, mx. Good (Alder 12/18).
- 9765 GERMANY (WEST) DW; 2110* English ID, talk about Steve Biko (Welch, Zilmer, Yacono).
- 9765 SEYCHELLES FEBA; 1735 Arabic religious pgm, ID, IS, etc. (Hermann 12/8).
- 9770 AUSTRIA ORF; 0000 German IS, ID, nx (Fraser). *0130-0200* English news, cmntry, tlk on human rights, etc. (Fick, Berezowski, Earhart, Welch, Sillings, Fraser).
- 9770 GREECE VOA (Kavala); *0200 Urdu w/IS, ID in English, pgm in Urdu (Alexander 1/1).
- 9770 SEYCHELLES FEBA; 1730 Religious talk in lang, mx, ID. Good level (C. Sherman 1/7).
- 9780 ALBANIA R. Peking; 0130 English w/mailbox & usual propaganda (Prath, Zilmer).
- 9780 USSR R. Peace & Progress; 1245 English news & talking about USSR (Woltman 12/5).
- 9780 YEMEN ARAB REPUBLIC R. San'a; 1205 Arabic nx, ID (Hermann). 1922-2109* Arabic Koran chanting, music & talk. (Sarrazin, Bogel, McCarthy, Desrosiers, Gavaras).
- 9790 ALBANIA R. Tirana; 0000 Albania with news and commentary (McKinney 12/12).
- 9850 EGYPT R. Cairo; 0435 Arabic with female singer (Johnson 12/13).
- 9860 CHINA R. Peking; 1638 English talk on animals in Tibet (Grenier 1/1).
- 9895 HOLLAND R. Nederland; 1325 English news, etc. Good signal (Fick).
- 9900 CHINA R. Peking; 1300 Russian w/IS, ID, Speech (Fraser 12/18).
- 9912 INDIA AIR; 1720 lang (Persian?), mx, tlk (Utter). 2115 EG ID, nx, mx (Sandborn).
- 9915 ENGLAND BBC; *1745 Swahili w/IS, EG ID, Swahili nx (Hermann 12/18).
- 9910 CHINA R. Peking; 0120 EG ID & cmntry (Yajko, Desrosiers, Cohen). 1137 lang tlk (Yajko)
- 9977 KOREA (NORTH) R. Pyongyang; 1225 EG talk & martial mx (Plotnick). 2120 Japanese talk & mx (Alexander). *2300-0048* English ID, sked, news, cmntry mx (Shine Forever the Fatherland of Korea, etc.). (Gavaras, Bishop, C. Sherman, MacKay, Brouillette, Sandborn, Cannon, Valko, Dunn).
- 10040 VIETNAM VOV (Hanoi); 1025 English ID, freq & sked (Burke 12/17).
- 10060 VIETNAM VOV (Hanoi); 1256 talk in lang w/singing. Weak signal (Strawman 1/2).
- 10690 USSR; 0347 Russian w/opera and folk songs, beeps, "Govorit Moskva" with Moscow Time Check. Feeder? Not listed? (Poppin).
- 11445 CHINA R. Peking; 0037 in Spanish w/talk by YL & Chinese opera. (Hywarren 12/31).
- 11495 USSR HS Pgm; 1145 Russian with music & talk by OM. IS.//5015 (Zilmer 12/28).
- 11515 CHINA R. Peking; 0031 Chinese music & lots of talk (Dunn 12/18).
- 11535 KOREA (NORTH) R. Pyongyang; 2320-0032 English News, Korean mx//9977 (Swanson, Sillings, Dunn).
- 11620 INDIA AIR; 1220 English state & development news, sked, etc. (Zilmer 11/21).
- 11640 PAKISTAN R. Pakistan; 1440 English talk on Arab countries (Osterman 12/31).
- 11645 SOMALIA R. Hargeisa; 1411-1505 Arabic/Somali talk & music (Osterman, Sarrazin).
- 11650 CHINA R. Peking; *0000-0055* EG ID, news, cmntry. (Desrosiers, Valko, Dubin).
- 11655 ISRAEL IBA; 1200 English w/news, cmntry, features, ads, wx, etc. (Zilmer 12/28).
- 11700 CHILE V. of Free Chile; 0209 English ID, discussion on human rights, talk about UN reports on Chile, etc. (Plotnick 12/27, Sillings 12/11).
- 11700 DOMINICAN REPUBLIC R. Clarin; 1905-2122 Spanish ID, talk & music. 2130-2204 English with talk about Miss Universe contest & asked for reports. 2300-0000 English w/Rudy Espinol who answered listeners letters over the air, IDs, etc. 0000-0720 Spanish IDs and music. (Dubin, Filka, Desrosiers, Woltman, Bance, Sillings, Alder, Miller, Swanson, Berezowski, Grenier, Sandborn, Prath, Burke, McCants, Blaize, Swanson, Vargo, Tiers, Yacono, Gallagher, Alexander). Wow!! - Odds and ends gleaned from listening to "This is Santo Domingo," Mon-Sat 2300-2400 on R. Clarin; also at 2130-2200, and this half hour is repeated during the 23-24 hour, not always the same day. In the 2nd half of January, R. Clarin will mail out a program sked for Feb-Apr. May is election month, and programming may change. No pennants available until 2nd half of 1978. On 12/13, there was a break in transmission at 2338 conjuring up visions of another 3-month period of silence, but they soon came back. However, on 12/14 at 2240 check, was off, but back at 2330, announcing at 2333 that there had been a power failure, then playing tape of 2130 pgm. On 12/18 noted on late 0603 in SP giving phone numbers. (Hauser).

Thank you to all who contributed this month. A lot of good items were sent. Welcome to those who reported for the first time! Until March, 73, *Don*

log report section



David L. Walcutt, Editor

11701 khz. & above

February, 1978

- 11704.3 CHILE VOC; 0209-0230 EG into SP, the story of international Marxism, directed against Chile while violating human rights, esp. in Russia, and spreading propaganda against Chile (Earhart 12/25); 0210-0230 EG, about Pres. Carter and UN (Reno 12/23); 0215 EG, on Chile's freedom (Swanson 1/3); 0225 EG, ID & frequencies (Yacono 12/22) 1 0240 SP, "La Voz de Chile", cmntry (Desrosiers 12/13). R. Nacional; 0145 SP, celebration about Pinochet's referendum victory, but very choppy signal as was 15149 (Hauser-PR 1/5).
- 11705 FRANCE RFI; 1720-1730 EG, PCA, Christmas mx, special Christmas Bumper Edition (Desrosiers 12/24); 1732 EG, PCA (Grenier 12/26).
- 11705 GUAM KTWR; 2244 EG, ID with ref. to 17830, 17855 and then played IS; SINPO 15332 (Hauser-TN 12/14).
- 11705 JAPAN R. Japan; 0010 EG, Japanese mx (Swanson 12/21).
- 11705 SWEDEN RS; 2257-2313 EG, IS, New Year's resolutions, mx, pen pal list (Welch 12/31); 2300 EG, IS, ID, nx, SCDX (Kukan 1/4); 0000 SP, news & comment by W (Prath 12/7).
- 11705 USSR 1325-1338 RS, heard "R. Atlantika" stated (Earhart 12/25).
- 11709.7 ARGENTINA RAE; *2300-2320 EG, nx, cmntry, mx, etc. beamed for N.Am. (E. Miller 12/10); *2302-2346 EG, nx & cmntry by M&F ancrs, folk & tango mx; good (Burke 12/7); 2320-2358* EG, fine tangos introduced by W; RAE will send px notes for 5 IRC's (Kerr 1/5); 2335-2350 EG, singing by a quartet in harmony -- said to be folk mx (Earhart 12/23); 2340 EG, talk about Buenos Aires (Prath-FL 12/23).
- 11710 USA WINB-Red Lion, PA; 0315-0333* EG, rel pgm, rel mx; ID in Spanish only at 0330 sign off (Alexander 1/1).
- 11714.9 ECUADOR HCJB; 2200-2300 JP to S.Am., //15294.9; not NHK! (DLW 1/20).
- 11720 AUSTRALIA RA; 0629 EG, nx of National Coalition returned to power (Dunn 12/10); 0730 EG, grain experimentation (Byron 12/29).
- 11725 AUSTRALIA RA; 1937-1945 EG, ID, pop mx, W ancr., report on drug surveillance in Australia; good (Bogel-CA 1/5).
- *11725 PHILIPPINES R. Veritas; 2220 Asian langs, Christmas and other kinds of mx; ID's (Bishop 12/24).
- 11730 GREECE VOG; 1525 EG, world nx followed by ID; poor (Yacono 12/26); 0015-0030 EG, nx by W; into Greek at 0030; good (Fraser 12/12).
- 11730 UK? BBC W.S.; 1505, special unlisted freq for Queen's Message to Commonwealth; stayed on till 1514 w/R. Newsreel (Hauser-TN 12/25).
- 11735NF MALAGASY REP. R. Nederland; *2130-2230 IN; 2230-2300 DT; 2300-0000 IN; 0000-0030 DT; not on 11730 (C. Sherman 12/31).
- 11740 AUSTRALIA RA-Shepp.; 0800 EG w/ID, freqs, and nx (Kukan 12/17).
- 11740 INDIA AIR GOS; 2132 EG w/ID and folk music (Hauser-PR 12/29).
- 11740 HOLLAND RN; 2030 EG, nx to Africa; //11730-Malagasy (Zilmer 12/26).
- 11750 UK BBC W.S.; 2115-2130 "Sandy Jones Show" pop mx (Fraser 12/23).
- 11755 FINLAND RF; 1839 FN, "Silent Night" sung in Finnish and cmnt on Christmas (Bryan 12/25). Buried beneath Moscow on 1/20 -ed.
- *11755 LEBANON R. Nacional del Libano; 0030 SP after Arabic mx; off at 0100. Inaudible on 9680 if moved to there at 0100 (Hauser-TN).
- 11755 SEYCHELLES FEBA; 0339 w/IS, heard once, then off; good signal while it lasted. (Hywarren 3/1).
- 11765 USSR RSP&P; 1040 EG, about neutron bomb (Prath 12/11).
- 11770 INDIA AIR; 2315 EG, cmntry & program preview (Hauser-PR 12/31).
- 11770 NIGERIA VON; 1820-1920 EG, nx & Afro mx, // 15120 (Zilmer 12/31, Yajko 12/12). Measured 11769.9 at 1905 on 1/20 -ed.
- 11775 ANTIGUA BBC W.S.; *1300-1330* to N.Am., nx & "Letter From America" on Groucho Marx and Bing Crosby (Fraser 12/25).
- 11775 SPAIN RNE; 0345-0355 SP w/ID, nx about Sadat & ME (Blaize 12/11).
- 11775 USA WINB; 2123-2145 EG, rel, QRM from Spain (McCants 1/4).
- 11780 BRAZIL RNB; 2050-2110 PT w/ID, good (Alder 12/9); 2127-2200 PT, ID & ment. Matto Grosso, M&W DJ's (Desrosier 12/26); 2130 PT, music (Saylor 12/13); 2200 "Voz do Brasil" pgm, poor (Yacono-NY 12/26).

- 11780v KOREA N. R. Pyongyang; 0000-0100* SP, nx, cmntry, mx; level better than //9420 (C.Sherman 1/7). Measured freq as 11780.6 at 2352 on 1/52; so I've egg on my face since I reported to Update that this was Argentina's R. Belgrano on exactly that frequency -ed.
- 11780 NEW ZEALAND RNZ; 0553-0600 EG, record requests and service from Auckland Baptist Tab. in the "National Program" (Osterman 12/25).
- 11780 USSR "R. Vilnius"; 2305 EG, news (Swanson 12/27).
- 11780 USA WYFR-Okeechobee; 2022 EG w/rel pgm, prayer, and readings; to Europe; mixing with Brazil; //9630 noted at 2100, good on both freqs; tnx to G.Ravenhorst for this tip (Hywarren 12/25).
- 11785 BRAZIL R. Gualaiba; 0205 PT w/ID (Yajko 12/28).
- 11790 USSR "R. Kiev"; 0040 EG, "Roundtable", on socialism (Saylor 12/15).
- 11792 COLOMBIA R. Nacional de Colombia; 1730 SP, mx, //15334 (Zilmer 12/26).
- 11800 NETH. ANTILLES TWR; 0300-0320 SP, rel, mx, good (Brown 12/19).
- 11800 SEYCHELLES FEBA; *0300 EG, IS, rel pgm, mx (Alexabder 1/1); 0446 EG, hrd only ID only heavy interference (Dunn 12/10).
- 11800 SOUTH AFRICA R. RSA; 2230-2300 EG (McCants 1/4, Prath 12/22).
- 11805 BRAZIL R. Globo; 0015 PT w/mx (Saylor 12/6); 0012 PT, Brazilian & US pop selections, ads & ID's (Bishop 12/12).
- 11805 VATICAN VR: 0100 EG, rel nx, //5995 and 9605 (Zilmer 11/21).
- 11810 ANTIGUA DW relay; 0341-0350* SP, mx (Earhart 12/12); 1305-1320 w/ID in EG and GM; nx, mx; good (Alder 12/29).
- 11810 AUSTRALIA RA-Shepparton; 2030-2100 EG, nx, mx (C.Sherman 1/7).
- 11810 GERMANY W. 1745* EG, Afr. Svc pgm; Zambia; good (Cohen-NJ 12/25).
- 11810 INDIA AIR; 1455-1500 EG, nx, ID, partial sked (Berezowski 12/24).
- 11815 NETH. ANTILLES TWR; 1123-2245 EG, "Light & Life Hour" (McCants 1/5).
- 11820 ASCENSION IS. BBC W.S.; 1849-1950, class mx (Bryan 12/25, Bogel 1/5).
- 11820 AUSTRALIA RA; 2125 EG, better than //1810 (Hauser-TN 12/17).
- 11820 NEW ZEALAND RNZ; 0927-0930 EG, pop mx, M reading story "Ring of Bright Water" about geese (Osterman 12/16).
- 11830 LIBERIA ELWA; 0627 EG/FR with IS/ID repeated, into children's chorus at 0630, some QSB; poor (Hutchins 1/1); 0815* unid. lang/EG, "Box 28400 Abidjan... box 192, Monrovia" (McMullen 12/10).
- 11835 USSR RSP&P; 1240 EG, nx & cmntry; fair (Yacono-NY 12/27).
- 11835.1 URUGUAY R. El Espectador; 0030 SP, ID's, orchestra mx, TC (Sandborn 1/5); 0150 SP, local then international news; "Buenos Noches" and off without anthem at 0207 (Petraevick 1/8). Freq: (DLW 1/2).
- 11835NF VATICAN VR; 1500 EG, apparent NF; IS to 1509 when English ID and anno. pgm to S.E.Asia -- in unid. lang (Cress-VA 1/6).
- 11845 SEYCHELLES FEBA; 0245-0300 unid. lang, w/IS & ID and Arabic-type mx (Alexander 1/1). Was on 11840; ex-11840? -ed.
- 11850 GERMANY W. DW; 1020 EG, to Asia, music (Prath 12/18).
- 11855 LIBERIA ELWA; 2053 EG, "Back-Bible", Liberian nx, ID's (Sandborn 12/17); 2105-2125 EG, barely audible (Berezowski 12/18); 2115 EG, local news, ID, end transmission at 2122 (Cohen-NJ 1/4).
- 11854.7 SAUDI ARABIA B.S.K.S.A.; 1858-1950 EG + AR, preview, Koran chant, Islam talk, 1915 nx, 1927 talk on Riyadh's recreational areas; 1930+ Western pop mx (Blossom-OH 12/30); 1900 EG, time/freq sked then Holy Koran and nx; fair (Zilmer 12/18); 2030 EG, nx, talk on Carter's trip, pop mx (Kukan 1/3); 2115-2148 EG w/ID as "R. Jeddah" followed by "String Sound" EL mx arrangements (Derosiers 12/12).
- 11860 ASCENSION IS. BBC W.S.; 0620-0630, world nx etc (Earhart 12/18).
- 11860 FRANCE RFI; 1702 EG, "Paris Calling Africa" (Grenier 1/8).
- 11860 LIBERIA ELWA; 2115-2125* EG (Zilmer 12/10, Hauser 12/12, Brown 1/8).
- 11865 ANTIGUA DW relay; 0005 SP, world nx & ID, good (Yacono-NY 12/20).
- 11865 CANADA RCI; 2000 EG, nx & ID's by W (Valko 12/31).
- 11865 CUBA RHC; 2045-2100 EG (Berezowski 12/11); 0000 SP (Prath 12/21).
- 11866.5 BRAZIL Radio Clube de Pernambuco; 0414 PT w/commercials and occasional ID's; 11865; fair (Hywarren-UMDX 1/12).
- 11880 SPAIN Voice of Spain; 0130 EG, nx & mx (Woltman 12/30).
- 11880 AUSTRALIA RA; 1430-1440+ EG, nx; to PNG from Shepparton (Brown 1/8); 1705 unid lang/EG anmts; considering time, a fair signal (Utter 1/1).
- *11880.7 ARGENTINA R. Splendid; 0001 SP, nx beginning "Informa Splendid" and ending at 0003 "Inform6 Splendid"; 3-tone chimes (DLW 1/21).
- 11890 FRANCE RFI; 1857 FR, rock mx, ID, and s/off (Bryan 12/25).
- 11895 NORWAY RN; 1800 EG, "Norway This Week", fair (Zilmer 12/18).
- 11900 AUSTRALIA RA-Carnarvon; 1503-1709 EG to S.E.As. (6 reporters); at 1555 ending "Point of View", a much more substantial pgm than I have come to expect from this station -- but they did their best to tri-

- vialize it by filling out the hour with pop music (Hauser-TN 12/17).
- 11900 SOUTH AFRICA R. RSA; *2153 EG, came on early and stayed on late w/ special New Year's Eve call-in pgm to 714-0068 (Hauser-TN 12/31); 2319 EG, New Years pgm, phone calls from world points (Desrosiers 12/31). I heard it; did the "right" people get advance invites? -ed.
- 11900 USSR 0345-0900 RS w/Mayak IS and time pips (Bogel-CA 1/3).
- 11905 ITALY RAI; 2225 EG, nx & mx beamed to Japan (Prath 1/1).
- 11905v IRAQ R. Baghdad; 1600 AR? (Ricchezza nd); 2200 AR, w/IS, ID and classical mx; poor (Zilmer 12/10); 0430-0501 (t) AR; M&W talking, mx, singing; fair (Alder 12/9); 0443 AR, local mx & vocals, TC at 0500 4 sec. late; fair but fluttery signal (Cress 12/20).
- 11914.9 ECUADOR HCJB; 0100-0545 EG to N.Am., rel pgm (6 reporters).
- 11925 BRAZIL R. Bandeirantes; 0001 PT, w/ID's and Brazilian mx (Sandborn 12/30); 0226-0246 PT, ment. Sao Paulo, ads (Earhart 12/27).
- 11925 NETH. ANTILLES TWR; 1205-1235* EG "Thru the Bible" (McCants 1/2); *0033-0045 EG w/IS, ID, "DX Special" language test (Welch 12/15).
- 11930 PHILIPPINES VOA; 2355 CH w/EG lesson, time pips (Mackay 1/8).
- 11935 SRI LANKA VOA relay; 1520-1600 EG, "Letters from Listeners" & "NY, NY" (Alexander 12/24), Greenville is: *1800+, this fay -ed.
- *11940 KUWAIT RK; 1420 AR w/practically continuous Arab-type mx but not of the Koranic type (Earhart 12/17). Try around 0500 also -ed.
- 11940 ROMANIA R. Bucharest; 0650 EG, nx by M&W (Dunn 1/1); 1303 EG, world nx & cmtry; good (Yacono 12/27); 1321 EG (Desrosiers 12/28).
- 11945 CHINA RP; 0058-0115 EG on reunification of Korea (Welch 1/3).
- 11950 KAZAKH SSR; R. Alma Ata; 2357-0035 RS-sounding; at 0000 bells toll six times for Kazakh time, followed by anthem (Blossom-OH 1/2+3).
- 11955 MALAYSIA BBC W.S.-Tebrau; 1015 EG, about Britain (Prath 12/11).
- 11950 USSR RSP&P; 1306-1318 EG, cmtry, nx, usual ID (Valko 12/7).
- 11960 ISRAEL IBA; 0510 EG, nx, wx, review of Israel press; for Aus/NZ (Cohen 12/22); 0520-0531* FR w/nx (DLW 1/20); 2000 EG, nx, cmnt (Zilmer 1/2); 2058 RS, w/ IS, ID, nx (Leffler 1/2).
- 11965 FRANCE RFI; 1730 EG with French music (Prath 12/25).
- 11970 CUBA RHC; 2330 SP with ID followed by guitar music (Yacono 12/20).
- 12000 AUSTRALIA VNG; 0729 EG, retardation of clock 1 Jan 78 (Dunn 12/10).
- 12000 USSR 1200 RS w/"Mayak" mx as given on page 125 WRTVH (Earhart 1/2).
- 12010 LIBERIA VOA-Monrovia; 1953-2300 EG to Africa, "African Safari" etc.; ute QRM (Hywarren 1/1, Earhart 1/3, Brown 12/26).
- 12015 AUSTRIA ORF; 1455-1505 GM, waltz mx, ID at 1500, nx (Fraser 12/26).
- 12077 ISRAEL IBA; 1430 HB, pop mx; Home Svc.; //15545 (Zilmer 12/25).
- 12085 KUWAIT RK; 1725 EG, pop mx (Dubin 12/7); 1740 EG, weather report (Burke 12/13); 1835-2001* EG, mx, NA (Sandborn 12/19, Hywarren 1/1).
- 12175 ICELAND Reykjavik R; 1200-1247 Icelandic; operatic mx; poor, sounded like SSB (Blossom 12/22); 1230-1240 EG, world nx with mentions of S.Afr., into Icelandic? at 1240 (Sarrazin 12/29).
- 15104.4 GRENADA RG; 2000-2200* EG, greetings, requests (13 reporters).
- 15105 ASCENSION IS. BBC W.S.; 1843 FR into 1900-1945* EG (Brookwell 12/22).
- 15105 FINLAND RF; 1315-1515 EG/FN (9 reporters); David Mawby said that during 1978 the Saturday Finn-DX pgm would become 10 minutes every 2nd Saturday rather than once a month at 25 minutes (Hauser 12/17).
- 15105 JAPAN RJ; *2200 EG w/IS, ID, into nx (Gallagher 12/30); 0030 EG, ending of DX pgm, freqs, and ending with nx & NA (Byron 12/18).
- 15115 ECUADOR HCJB; 1430-1525 EG (5 reporters); 0440 SP (Desrosiers 12/8).
- 15115 PAKISTAN R. Pakistan; 1100-1115* EG, dictation nx (C.Sherman 1/4).
- 15120 NIGERIA V.O.N.; 1700 EG, pop & Afro mx; poor (Zilmer 12/18); 1758 OC into drums IS, *1800 EG with the lousiest modulation ever; IS booming but terrible quality audio on the program (Hywarren 1/2); *1800 EG, nx (Swanson 12/31); 1903-1927* EG, nx, press review, pgm preview, ID as international svc.; bad het & QRM (Desrosiers 12/14); 1915-1935 EG, roundup on Lagos Trade Fair; into FR at 1930 (McMullen 12/10); 2004 FR, beautiful local music (Leffler 1/2).
- 15120 VATICAN VR; *1700 EG, church nx (Leffler 1/2, Zilmer 12/17).
- 15125 GERMANY E. RBI; *1200-1220 EG to S.E.As. w/nx, mx, etc.; not on 15115 as reported in December FRENDX, at 1200 (E.Miller 12/26).
- 15129.8 CHILE VOC; 2321 EG, on human rights (Grenier 12/17); 0230 SP/FR/EG at 20 min. intervals (Sillings 12/10); 0321 EG (Bryan 12/28).
- 15130 USA WYFR-Okeechobee; 1815-1950* EG, Bible study with Clifford Wilson (Desrosiers 12/14); 2152 PT, new pgm w/EG Bible (Hauser-PR 1/3).
- 15140 SWITZERLAND SBC; 1315-1345 EG, into 1345 FR (7 reporters).
- 15145 BRAZIL R. Jor. Com.; 2030 PT w/soccer game; f-g (Bishop 12/11).

- 15145 PORTUGAL RFE; 1556-1605 Polish, on Uniroyal Corp. (Hermann 12/17).
- 15150 CANADA RCI; 2130-2158 EG to Afr. (Cress 1/4, Brown 12/30).
- 15155 GUAM KTWR; 2200-2244 EG w/ID and pgm in Indonesian (McCarthy nd).
- 15155 SOUTH AFRICA R. RSA; 1706-2320* DT/GM/FR/EG (12 reporters).
- 15160 AUSTRALIA RA-Lyndhurst; 0640 EG, pop mx (Grenier 12/26, Dubin nd).
- 15160 HUNGARY RB; 1205-1230* EG, nx, mx (E. Miller 12/26, Yacono-NY 12/23).
- 15160.4 MEXICO XEWW; 2100-2115 SP w/ads, nx, ID "V. Am. La." (Gallagher 12/30).
- 15175 GUAM KTWR; 2159-2212 w/ ID in EG and into IN, mx; good (Alder 12/13); 2200-2230+ EG w/ID, then pgm in Indonesian; good (Brown 12/30); 2200-2258* w/ EG ID's and Indo. pgm, religious in nature (M. Smith nd); 2201 EG w/IS, ID by female into Indonesian pgm which consisted mostly of music; severe interference from Radio Nederland at 2225; fair (Gavaras 12/25); 2215-2230 IN w/island & rel. mx, many ID's, exc. signals (Sarrazin 1/2); 2250-2300* EG Christmas mx (Dunn nd).
- 15175 NORWAY 1405-1415 EG, marred by horrid QRM (Kerr 12/18).
- 15190 CONGO RTVC; 1632-2215 FR/EG (2130-2230 EG) (9 reporters); 1632-1702 EG, "Voice of Namibia" pgm with polit. cmnt. (Desrosiers 12/13).
- 15220 MALAGASY REP; 2030-2120* EG to Africa (Zilmer 12/26, Berezowski 12/7).
- 15225 TUNISIA R. TV Tunisienne; 1200 AR, time pips, ID by W, talk by M (Taylor 12/13); 1530-1601 AR, march mx, local mx (Blossom 12/30).
- 15240 GERMANY E. RBI; *1245 GM w/IS, ID & world nx (Yacono 12/23). 12/24).
- 15250 ROMANIA RB; 1300-1325 EG, nx, tourist pgm (McMullen 12/27, Miller).
- 15255 NETH. ANTILLES TWR; 1228-1330 EG w/Bible (McCants 1/7, Prath 12/18).
- 15260 ASCENSION IS. BBC W.S.; *2000 to Americas, world nx (Yacono 12/27).
- 15260 CANADA RCI; 1800 EG, weekend magazine & DX Digest (Sandborn 12/18).
- 15260 FINLAND RF; 1300 EG, nx, //15105. Poor. (Zilmer 12/26).
- 15260 IRAN VOI; 1400 unid lang w/IS at 1400; fair; //15084 (Zilmer 12/26).
- 15270 CHINA R. Peking; 1200 EG, nx, cmnt, mx; poor (Zilmer 12/20).
- 15270 JAPAN R. Japan; *2343-0044* EG to N. Am. (13 reporters). Some names: Welch, Brouillette, Reno, Burke, Bunce, Richezza, Sillings, Dubin.
- 15273 URUGUAY (t) S.O.D.R.E.; 2322-0008 SP, rock w/EG artists; no ID but between KGEI 15275 & R. Japan 15270. Poor. (McCarthy-FL nd).
- 15300 FRANCE RFI; 1705 EG with IS, ID, nx, pop mx (Sandborn 12/18).
- 15305 SWEDEN RS; 1240-1300 EG, nx, talk on stamp collecting (Reno 1/2); 1255 EG, mx pgm (Prath 12/25). Moves to 11790 at 1300, I think -ed.
- 15307.6 GUINEA R. Nationale; 2100 FR w/ID "La Voix de la Revolution" and Vernacular talks/chants; ID by M at 2115 "Tei Conakry, Radiodiffusion Nationale" followed by more chants; 15309 w/ slight het (Hywarren-7UMDX 11/26); 2122-2215 FR/unid lang, African mx and guitar IS (Blossom nd); 2225 FR, nx (Taylor 12/27); 2330 FR, hi-life mx, almost no talk until 0000 when ID (t) by female (Mackay 1/6).
- 15315NF NETH. ANTILLES RN; 0145-0206 SP, ex-15310 in sked (Earhart 12/27).
- 15315 SWEDEN RS; 1400 EG (to S. Asia -ed); ID, nx, SCDX (Sandborn 12/20).
- 15333.9 COLOMBIA R. Nacional; 1945 SP, classical mx, pgm promos (Taylor 12/27); 2140 SP, classical mx pgm, ID by W & TC at 2146; then back into mx; good, but het; //11705v and 9655 (Hywarren-7UMDX 5/1).
- 15385 MALAGASY REP. RN; *1825-1844 EG to Afr., Happy Station w/ Tom Meyer, nx; fair, RAI QRM; //11730 (Desrosiers 1/1, Zilmer 12/10).
- 15385 MEXICO RM; 0035-0045 SP, Mexican mx, comedy pgm? (Desrosiers 12/19).
- 15400 VENEZUELA R. Nacional; 2120 SP with Venezuelan mx; fair w/QRM; do they still offer the large green pennant? (Hywarren 1/2); 2207-2220 SP with ID, mx, tlk on economy; good (Alder 12/9).
- 15420 ANTIGUA BBC W.S.; 2000 (-2115 to S. Am. -ed), nx (Leffler 1/2).
- 15420 CYPRUS BBC W.S.-Limassol; 1455, ech effect (Desrosiers 12/28).
- 15425 AUSTRALIA ABC; 0434 EG, world nx, TC's (Dunn 12/10).
- 15425 TAIWAN VOPG; 0100-0145 EG, Chinese mx pgm (Zilmer 12/11, Brookwell 12/11, Reno 12/23, Berezowski 12/5, George 1/4).
- 15435v TANZANIA RT; 1750-1821 EG, nx re: Namibia & Africa (Hermann 12/10).
- 15520v PAKISTAN RP; 1430-1502 Urdu w/stringed Pakistani mx; ID and news at 1500; very good signal (Gavaras 12/23).
- 17665 PAKISTAN RP; 0831 EE/unid lang, ID followed by news (Dunn 1/1).
- 17710 NEW ZEALAND RNZ; 0435 EG, Christmas & band mx; good (Altman 12/21).
- 17713.2 CHILE VOPG; 2248 FR, new freq, ex-1780lv, harp mx; het VOA 17710 (Hauser-TN 12/14); 1835 EG, measured fqy (DW 1/20).
- 17745 SWAZILAND TWR; 1945-2015* FR, rel tlk & mx; IS once at sign/off; good-medium level (C. Sherman 1/8, Mackay 1/8).
- 17790 SWEDEN RS; 1320-1338 FR, ex-15305; ok until BBC came on at 1335 (Earhart 12/18); 1400+ EG, about Nobel prizes (Earhart 12/10); 1400-1430 EG into 1430 SW; Panorama. Good. (C. Sherman 12/31, Cohen 1/3)

- 17790 UK BBC W.S.; 1305-1315 EG, on Israeli offer to Palestinians on W. Bank; no QRM from Sweden this morning (Earhart 12/19).
- 17810 HOLLAND RN-Lopik; 1630-1700 AR w/IS, nx, cmnty; QRM from bird-chirp IS (Italy? -ed); weak signal (Derosiers 12/14).
- 17810 NETH. ANTILLES RN-Bonaire; 2030 EG w/IS, ID, "Newline" and special edition of DX Jukebox with World Radio Club (Kukan 12/29).
- 17815 ISRAEL IBA; 1200 EG, nx, cmnt, wx, ads; to S.E.As., fair (Zilmer 12/28); 1221 EG, cooking recipe & TGIF pgm; poor (Osterman 12/16).
- 17825 VATICAN VR; 1458-1520 EG to India & Southeast Asia, IS, ID; into Hindi at 1515; QRM de RCI (Welch 12/19).
- 17830 PAKISTAN RP; 0312 Swahili, chanting Pakistan mx (Bryan 12/28).
- 17830 SWITZERLAND SBC; 1631 FR w/ID, heavy QRM (Leffler 1/2).
- 17840 ASCENSION IS. BBC; 1633 EG, "Banners & Bonnets" (Leffler 1/2).
- 17845 USA WYPR-Scituate; 1340 with bad ripple on carrier; Arthur Thompson later informed me they're having trouble with their frequency synthesizers here & in FL introducing a 500 hz pulse onto their carriers; they are unable to monitor the trouble themselves!; no doubt it would help if dxers phoned WYPR when the buzz is heard: (617)-545-5700; or if from FL, (813)-763-0281 (Hauser-TN 12/11). By 1/20 seemed to have been reduced from an aggravating buzz to merely an annoying hum -- on this freq at least -ed. 1952-2015 EG, mx, nx, "Family Bible Reading Fellowship" pgm (McCants 12/26).
- 17855 LIBERIA VOA-Monrovia; *1730 PT to Africa (Bryan 12/25).
- 17865 RWANDA (?) DW; 1200 EG, nx & cmnt to Africa (Prath 12/26). Seems to me a W.Germany site is more likely propagationally at this freq if Africa is the target area, in terms of skip distances -ed.
- 17870 LIBERIA VOA; 1722 EG, "Africana" w/Tanzanian interview (Bryan 12/25); 1639 EG, rock mx w/female disc jockey (Leffler 1/2).
- 17880 GERMANY E. RBI; 1400 EG, nx, cmnt, topics, mx (Zilmer 12/26).
- 17885 CYPRUS BBC W.S.-Limassol; 1540-1605, chamber mx & nx (Earhart 12/18); 1600-1615, news, poor but good ID (Reno 12/31).
- 17890 USSR 1609-1619 RS, M&F nx, unid which svc. (Earhart 12/18).
- 18080 UK BBC Asia Svc.; 1300 Cantonese talk (Yajko 12/27).
- *18317a MEXICO La Pantera (?); 2210 SP, lively L.A.m. stn w/occasional fade-ins; no ID heard but very likely La Pantera, previously heard on 18315; checked fund. of 6105 and found instead a carrier on 6105.7 which fits (Hauser-TN 12/16). I hear Mexican mx on 18314.8 w/ment. "La Pantera" -- at respectable level, at 2040 on 1/22 -ed.
- 19369h ALGERIA (?) 1408 Arabic mx, likely Algiers 2 x 9684 $\frac{1}{2}$ (Hauser 12/10).
- 19480h PORTUGAL RP; 1530 PT, sports, //21700; 2 x 9740 (Hauser-TN 12/17).
- 21455 AUSTRALIA RA; 2330 EG, M DJ, pop mx pgm; strong (Hart 12/27).
- 21460 BELGIUM BRT; 1541-1545 FR, pop mx, //15210 (Leffler 1/2, Zilmer 1/1).
- 21465 EGYPT R. Cairo; 1230-1243 AR, classical and Arabic mx, talks; fair (Zilmer 12/31, Kukan 12/15).
- 21475 BELGIUM BRT; 1530 DT, pop mx, //17740, fair (Zilmer 1/1).
- 21495 PORTUGAL RP; 1835 EG to ME/India, interview, echo (Sarrazin 12/17).
- 21500 ISRAEL IBA; 1200 EG, nx, cmnt, wx, ads; fair (Zilmer 12/31).
- 21535 SOUTH AFRICA R. RSA; 1415-1425 EG, item on agreement between Kenya & Zambia airlines (Welch 1/2); 1546 SH, "Baracuda" sung (Leffler 1/2); 1610-1650* EG, Christmas carols, review of '77, Christian Barnard (Ihnat 12/26, Blossom 12/30, Byron 12/3, Earhart 12/30).
- 21525 HUNGARY R. Budapest; 1430-1453 EG, about trade between Eastern Eur. & the West; short ID; free of QRM (McMullen 12/22). Oops, missort!
- 21540 GERMANY E. RBI; 1400-1415 EG, nx, cmnt (Zilmer 1/1, Welch 12/19).
- 21555 SWEDEN RS; 1345 SW, tlk & mx; in Upper Side Band (Zilmer 12/30).
- 21580 FRANCE RPI; 1545-1600* PR to W.Afr. (Earhart 12/26, Leffler 1/2).
- 21585 SWITZERLAND SBC; 1552 PT to S.A.m., on Swiss economy (Leffler 1/2).
- 21600 LIBERIA VOA-Monrovia; 1730* relay to Africa; poor (Brookwell 12/27).
- 21640 HOLLAND RN; 1554 AR w/ID & "Guantanamo" mx (Leffler 1/2).
- 21640 MALAGASY REP. RN; 1635-1719* AR, some mx & address (Earhart 12/10).
- 21640 NETH. ANTILLES RN; 2032 EG, nx, ID; fair, lite QSB (Hywarren 12/28).
- 21670 USA VOA-Greenville; 1715-1730 EG to Africa (Earhart-PA 12/18).
- 21685 MALAGASY REP. RN; 1605-1615 DT, Dutch songs (Earhart 12/26).
- 21700 PORTUGAL RP; 1745-1800 PT, song by M, song by W with accordion accompaniment; 1750 song by female; 1758 gave khz & probably ID (Earhart 12/18).
- 21710 UK BBC W.S.; 1558, "Outlook"; to N. & W. Afr. (Leffler 1/2).
- 21730 NORWAY R. Norway; 1400 EG, "Norway This Week" (Zilmer 12/23).



Distr. Editor: Greg Ravenhorst

FRENDX CREDITS

Rural Route, Hollandale, MN. 56045

FEBRUARY AND MARCH DEADLINES FOR ALL LOG REPORTS - 13th OF THE MONTH. ALL OTHER MONTHS FOR 1978 - 12th OF THE MONTH.

Thanks go out to the 86 reporters this month.

Bill ALDER, San Antonio, TX (SPR4)...Brian ALEXANDER, Mechanicsburg, PA (DX160)
 Richard ALTMAN, Knox, PA (DX-160)...Robert BEREZOWSKI, Calgary, Alta, Canada
 (DX-160)...Gerry BISHOP, Christiana, PA (DX-160)...E.V. "Sandy" BLAIZE,
 Metairie, LA (51J3)...Tom BLOSSOM, Austinburg, OH (SPR4)...Bill BOGEL, Santa
 Barbara, CA (FRG7)...Dale BOHLKE, St. Louis Park, MN (Zenith)...Larry BROOK-
 WELL, San Diego, CA (SPR4)...W. Noel BROWN, Ann Arbor, MI (SB-313).....
 Josephine BRYAN, Stockton, CA (FRG7)...William BUNCE, Browns Mills, NJ (FRG7)
 Arthur BURKE, Jr, Leesburg, FL (SPR4)...Albert CANNON, Jr, Wilmington, NC
 (HQ-100AC)...William CLARK, Cherry Hill, NJ (FRG7)...Tony CLIFT, Campbellville
 Ont, Canada...Jon COHEN, Willingboro, NJ (FRG7)...Hadley CRESS, Harrisonburg
 VA (HRO-500)...Joe DELAP, Prairie Grove, AR (FRG7)...Roland DESROSIERS,
 Chicopee, MA (R-388)...Jeff DUBIN, Philadelphia, PA (FRG7)...Guy DUNN, Glens
 Falls, NY (SPR4)...Kenneth EARTHART, Allentown, PA (FRG7)...Dean FICK, Lake-
 side, OH (DX-160)...Dennis FILKA, Parma Hts, OH (SPR4)...Robert FLECK, Oak
 Park, IL (SW4A)...Jay FLORIAN, Round Lake, IL (SPR4)...Robert FRASER,
 Cohasset, MA (XCR-30)...Dan GALLAGHER, Denton, TX (DX-160)...Editor Tom
 GAVARAS, Wayzata, MN (HQ-180)...Charles GEORGE, Dallas, TX (SSR1)...Pete
 GRENIER, Azusa, CA (FRG7)...Christian HANSEN, Yonkers, NY (SPR4)...Irwin HART
 Grass Valley, CA (DX-160)...Dave HASCALL, Portville, IN (S-53A)...Editor
 Glenn HAUSER, Knoxville, TN (plus Puerto Rico, Miami, and points between)
 (FRG7/HQ-180)...Frank HERMANN, Kitchener, Ont, Canada (DX-160)...Emmett HOFF-
 MANN, St. Louis, MO (51S-1)...Charles HUTCHINS, Rumford Pt, ME (FRG7).....
 Aaron HYWARREN, Winnipeg, Man, Canada (AR2A/ICF-5900W)...Joe IHNAT, Jr,
 Coraopolis, PA (DX-160)...Dale JOHNSON, Pinawa, Man, Canada (SB-310)...Jack
 JONES, Jackson, MS (DX-160)...Nelson KERR, Jr, Towson, MD...Robert KUKAN,
 Irvington, NJ (HQ-180)...Irving LEFFLER, Brooklyn, NY (SPR4)...Editor Jerry
 LINEBACK, St. Joseph, IL (SPR4)...Don MACKAY, Newark, DE (SPR4)...Eric MILLER
 Dorchester, MA (Zenith)...Donald McCANTS, Trussville, AL (GE port)...Dan
 McCARTHY, Kissimmee, FL (DX-160)...Larry McKinNEY, Adamstown, PA...Bill
 McMULLEN, Ann Arbor, MI (DR-22)...John ONKEN, Metamora, IL...Sydney OSTERMAN
 Toronto, Ont, Canada (FRG7)...W.J. PEARSON, Avonmore, PA (DX-160)...Neal
 PERDUE, Falkville, AL (HA-600A)...Don PETRAVICK, Chicago, IL (2C)...Alan
 PLOTNICK, Hamden, CT (XCR-30)...George POPPIN, San Francisco, CA (FRG7).....
 John PRATH, Ft. Lauderdale, FL (DX-160)...Louis RENO, Atchison, KS (SPR4)...
 Ed RICOZZEZA, Philadelphia, PA (SW4A)...Bill SANDBORN, Savannah, TN (FRG7)...
 Garry SAPOZNIKOW, Winnipeg, Man, Canada (FRG7)...David SARRAZIN, Denver, CO
 (NC-183D)...Brett SAYLOR, Altoona, PA (DX-160)...Clayton SHERMAN, Hoosick
 Falls, NY (SPR4)...John SILLINGS, Cornwall, NY (SW-717)...Editor Myron SMITH
 Spencerport, NY (SX-190)...Jerry STRAWMAN, Cedar Rapids, IA (FRG7)...Richard
 SWANSON, Wellman, IA (DX-160)...Leon TANNENWALD, New York, NY (SPR4).....
 Mitchell TAYLOR, Riverdale, GA (DX-160)...Mike TIERS, W. Vancouver, BC, Canada
 UNIVERSITY OF MANITOBA DX CLUB, Winnipeg, Man, Canada (SPR4)...Richard UTTER
 Rochester, NY (SPR4)...Dave VALKO, Dunlo, PA (DX-160)...Joseph VARGO, Detroit
 MI...William WELCH, Tallahassee, FL (DX-160)...Frank WOLTMAN, Cambridge, WI
 (FRG7)...Dominick YACONO, Brooklyn, NY (Zenith)...Robert YAJKO, Leechburg, PA
 (SPR4)...Robert ZILMER, Milwaukee, WI (SPR4)...ALMOST FORGOT to mention:
 Paul BROUILLETTE, Sault Ste. Marie, MI (DX-160)...

+ + + + + + + + + +
QUESTION FOR MEMBERS On the Credits Page, do you find it more important to have the contributors town included, or do you prefer to know all of the radios that he has for his use in SW? Example: Would you prefer: Greg Ravenhorst, MN (R4C/DX-160/Grundig)...OR...Greg Ravenhorst, Hollandale, MN (R4C)... showing primary receiver only. LET ME KNOW YOUR PREFERENCE. Some have written me about this. If I don't get much response, it'll stay the same.
ADDRESS Please notice that I want everything sent to my Hollandale address again. This is because previously it was thought that I would not be back in Hollandale, until April. Now, I could go back on 4 days notice. If I'm still up here, there's only 1 day forwarding delay. Many ask what am I doing going NORTH for the winter. No, I haven't lost my marbles! Work for the winter meant going to Hackensack, building homes on lakeshore. -30 F. today! 73, *Greg*

NASWA "UNITY AND FRIENDSHIP" ★

PUBLISHES FRENDX MONTHLY

NASWA MEMBERSHIP FEES:

First Class Worldwide.....	\$13
Airmail to Central America, Caribbean, South America, Europe.....	\$20
Airmail to Asia, Africa, Pacific.....	\$22

All remittances must be in U.S. funds and mailed to: NASWA, P.O. Box 13, Liberty, IN., 47353, U.S.A.

UPDATE: Besides FRENDX, NASWA also publishes UPDATE... a midmonth newsletter with the very latest DX news while it's still news. (UPDATE also appears in each issue of FRENDX). It is only available to NASWA members.

"UPDATE" SUBSCRIPTION RATES PER YEAR:

North America (First Class).....	\$3.
Overseas (Airmail).....	\$5.

Sample copies of FRENDX and UPDATE are available for \$1.00

EXECUTIVE DIRECTOR - Mac Leonhardt, P.O. Box 13, Liberty, IN., 47353

PUBLISHER & MANAGING EDITOR - William E. Oliver, 45 Wildflower Rd., Levittown, PA., 19057

SHORTWAVE CENTER - Jerry Lineback, P.O. Box 325, St. Joseph, IL., 61873

QSL REPORT - Sam Barto, 245 Cherry Ave., J-11, Watertown, CT., 06795

UPDATE EDITOR - Tom Alleman, 615 W. 43rd Terrace, Apt. 6, Kansas City, MO., 64111

SCOREBOARD - Myron Smith, 36 Ogden Center Rd., Spencerport, N.Y., 14559

DISTRIBUTING EDITOR - Greg Ravenhorst, Rural Route, Hollandale, MN., 56045

LOG REPORT (A) - Dan Robinson, 5004 Fulton St. N.W. Washington, D.C. 20016

LOG REPORT (B) - Steve Wiseblood, 707 Loma Way, Santa Maria, CA., 93454

LOG REPORT (C) - Tom Gavaras, 16920 17th Ave., N. Wayzata, MN., 55391

LOG REPORT (D) - David Walcutt, P.O. Box 1051, Carbondale, IL., 62901

LISTENERS' NOTEBOOK - Glenn Hauser, c/o WUOT, Univ. of Tenn.,

232 C & E Building, Knoxville, TN., 37916

AWARDS CHAIRMAN - Dan Henderson, 7921 Anfred Drive, Laurel, MD. 20810

COUNTRY LIST CHAIRMAN - Don Jensen, 5204 70th St., Kenosha, WI., 53140

U.K. REP - Alan Thompson, 16 Ena Ave., Neath, W. Glamorgan,

Great Britain SA11 3AD

FIRST CLASS MAIL

NORTH AMERICAN SHORT WAVE ASSOC
POST OFFICE BOX 13
LIBERTY, INDIANA 47353 U.S.A.

