

# F R E N D X

*North American Short Wave Association*

## SWBC NEWS 4-75

**NOTICE** After an effort of nearly two years, I (Dan Ferguson) have finally found someone to take over the work of handling NASWA HDQS and getting FRENDX published and mailed. The next issue of FRENDX (May, 1975) will be the last to be mailed from the Charleston, WV, area. Beginning with the June, 1975, issue FRENDX publishing will be handled by Alan Mayer of Park Forest, Illinois. Headquarters mail, renewals, etc., will be handled by Mac Leonhardt, who is currently editor of the B section of Log Report. I will continue to keep the Box in S. Charleston, and will forward any mail received to Mac Leonhardt for handling.

If your membership expires after the May 1975 FRENDX (i.e., if your last scheduled issue of FRENDX is June 1975, or later), your renewal can be sent to Mac Leonhardt at the address given on the heading for the B section of Log Report. If your last issue of FRENDX is scheduled to be the April, 1975, or May, 1975, issue, it will simplify matters if you will send your renewal to the South Charleston address on the back of this bulletin.

**ABOUT FLASHSHEET** Getting FRENDX published is quite enough for one person. However, Alan Mayer has indicated that he will try to handle FLASHSHEET publishing also, if it is changed to only one separate mailing per month. PERHAPS ONE OR MORE OTHERS IN THE GENERAL AREA OF PARK FOREST, ILL., CAN PROVIDE SOME HELP WITH THE PUBLISHING OF FLASHSHEET AND/OR FRENDX. Publishing help needs to be within reasonable distance of Alan Mayer, since he will have the addressing machine, used for addressing both FRENDX and Flashsheet. Alan will be in contact with members in Illinois/Indiana. YOUR HELPING IS IMPORTANT!!

I am expecting to redo my listening set-up during the summer, and hope to be listening and reporting to the various sections of FRENDX during the next DX season. Perhaps, from time to time, I'll be able to put together an article for SWC as well.

#### THE LOUDENBOOMER REPORT

One of my excursions this past summer had me exploring the delights of Peru, a tour more frequently taken by our European DX friends.

It would be impossible in the paltry amount of space allotted to me here, to cover my trip fully, but you will be interested in at least one Andean account I'm sure.

One of my stops was a delightful day spent in Huancayo. I arrived on a Saturday afternoon, checked into the Hotel Turistas, bought a map of the city, had a pisco sour and sat down to study the lay of the land.

As you well know, there are several broadcasters in Huancayo, among them, Radio Negativo. I had sent a sufficient number of reports to this outfit to know that the station was located on Calle Real and I had every intention of paying them a visit. Another pisco sour, and I was ready.

A few minute's walk found me in front of a two story structure of some considerable age. A small sign announced "Radio Negativo." So this was it!

I entered a hallway and to my right I could see a man seated behind a control board playing records. Another man came out of an office to my left. I introduced myself and said that I was one of their listeners from Estados Unidos. The man, who turned out to be Sr. Alfonso Nunca V., the gerente, lit up in a brilliant smile. Obviously he was delighted to see me and I had hopes of success at last in obtaining my long-sought QSL.

After a quick tour of the single studio and office, we went up to the second floor which served as Sr. Nunca's apartment. And, over pisco sours, I asked him why DX'ers so seldom received replies from Radio Negativo.

"Ah, the mail here is no so good as it perhaps is in your country. We do not get much mail from outside Peru."

I asked him about the few he did receive.

"Well, we reply to those but perhaps it is that those do not get out. Besides, the time available to do these favors is not much. For example, tonight I have to run the station so my assistant can have an evening off, and tomorrow I will have to go to Ayacucho."

"I see", I said, "Well, do you think you could give me a QSL before I leave? I have my report right here."

"Certainly my friend," the gerente replied. "But first, another pisco sour!"

We sat talking awhile and then the announcer came in carrying a huge basket full of bits of paper, leaving a trail fluttering behind him.

"Ah, here are the requests for tonight," said Sr. Nunca, stirring them around with his hand.

"That's quite a few," I remarked.

"Si. Tomorrow is Sunday, fair day, so the city is already crowded. We shall be on the air late tonight!"

I picked up a handful and looked at them. They were small printed forms with space for the name of the song requested, artist and name of the person for whom the song was to be played. I turned one over and on the back saw the words "I would be happy to receive..." The reverse side of a second one had "NPO 34333" typed on it! I began to get an inkling of what was really happening here! I downed the rest of my pisco sour and said that I thought I'd better be getting back to the hotel and what about my QSL?

"Ah si, I'll type it right up for you. Have another pisco sour while you wait."

I did. And Sr. Nunca began to plunk away at his typewriter. With a flourish he signed, stamped and handed me a viewcard of Huancayo on fair day which said "This QSLs your receipt of Radio Negativo, Huancayo, 5,835 kcs."

I thanked him, we said goodbye and I walked out into the late afternoon sun, headed back to the hotel. The crowds were already gathering and somehow, in the effort of dodging oncoming people, my QSL slipped out of my pocket and was lost!

I fumbled my way back to the hotel, had a sorrowful dinner and drowned my sorrows in you-know-whats.

Next morning, I had a train to catch and I'd overslept. I was late, so I couldn't take the time to do anything about the youngish European fellow buying postcards at a souvenir stand near the hotel. One of them seemed to have something typed on the back.

Too bad. If I'd had the time, I'd have invited him to have a pisco sour with me!

# Shortwave Center

Charles A. Wooten  
4911 Battery Lane, Apt. 1  
Bethesda, Maryland, 20014

## Down Memory Lane

by Charles H. Brunner, Jr.

Circa 1922 my father received a home made radio set from a friend, who, incidentally, was a chief surgeon. Undoubtedly his surgical skill was put to a different use when wiring the set. Even though the set had no cabinet, it consisted of a bakelite panel, some tubes and operated on big dry cell batteries - arranged in series.

The panel had three spider-web coils for its tuner; the middle one being in a fixed position, and the ones on each side were hinged so they could be swung out and back with both hands until a station was heard. Each coil was many windings of copper wire on a piece of thin fiber board.

The set had an on/off switch and a volume control - but, of course, no calibration. We used a phone jack for at least two different stages, and by plugging in our 4 headsets in series we were all able to hear signals. In 1924 we listened to the 103 roll calls for Presidential Nomination at the Democratic Convention.

About this time, medium-wave DX-ers had a ball. Each night the MW stations in the Eastern Time Zone shut down at a set time, and we heard the Mid-West or Central Zone Stations: Chicago, St. Louis, the famous Kansas City Night Hawks and Ft. Worth. An hour later they shut off and the Rocky Mountain stations were heard. Then the stations in this zone closed down and we listened to the Pacific Coast: KFI - Los Angeles; KGO - San Francisco, etc. I do not remember if all stations had to sign-off, but the process gave us clear channels for DX-ing. One night my rather heavy aunt shook the floor and a spider web coil moved slightly and we jumped from WOO in Philadelphia to KDKA in Pittsburgh!

Then we bought a Garrod Neutrodyne set with a separate powered upright horn speaker. This, as I recall, was powered by house current and created a lot of squeals in neighborhood sets.

In 1934 I bought a Philco Table Radio. It has SW bands 2.3 to 2.5 and 6.5 to 18.0 with vernier tuning. The I got QSL cards from 2LO - London; Binhoven, Holland; and an EAQ - Spain; and also Switzerland. Among other things, the Depression helped to curtail my DX-ing around 1935.

In June 1973 I bought a Zenith Trans Oceanic D7000Y and with it have logged 110 countries using mostly its attached whip antenna, but sometimes a long vertical wire which carries my VHF/UHF leads from my 56 foot tower. I still use the beautiful Philco. I have even used 2 fourteen foot traverse curtain rods as a dipole.

Yes, the old days were easier for many DX-ers: nothing like the high powered mess nowadays....

## FACTS ABOUT VOA

AS RELATED BY NASWA REPORTER

David C. Mackes in conjunction  
with a trip to Greenville, N.C.

The Edward R. Murrow Transmitting Station is located near the city of Greenville, North Carolina. The station is divided into three parts: transmitter sites A and B, and the manager's office and receiver plant at site C. The three sites form a triangle with sides of 25 miles.

When you drive up to the gate, you must get out of your car, call in on the gate telephone, and explain your business. Then the gate is opened electrically by remote control. The first place I visited was site C. I signed the guest book and was then introduced to Mr. William Harmon, the station manager. He told me about VOA, and Greenville in particular.

Sites A and B are transmitter stations. They are both identical. Each station covers 2500 acres. At each site there are 3x500kw, 3x250kw, and 3x50 kw transmitters for broadcast use. In addition, each plant has 2x40kw Independent Side Band (ISB) for

point-to-point use. Power comes in at 465 kv, stepped down to 4.6kv for direct use by the 500kw transmitters. The voltage is reduced even further for other transmitters.

The 500 kw transmitters were made by Continental Electronics and use the Doherty high efficiency amplifier circuit. The modulator and final tubes, of which there are 8, are cooled by water flowing at 30 gpm. The 250 kilowattlers were made by General Electric and are vapor cooled, i.e., the tubes which dissipate a lot of power sit in insulated containers and constantly boil water into steam. The 50 kw transmitters are Gates units. It is interesting to note that transmitter heat is used to warm the building in winter.

Right next to the transmitter building is the switchhouse. The high power RF enters through screened feeders. It is then connected to the correct antenna. All antennas are fed by means of 300 ohm open transmission line.

At each of the transmitter sites there are 14 dual and triple band slewable curtain arrays with a gain of 20 db. Site A has 21 rhombics and 2 log periodics, which are used for point-to-point. Site B has 20 rhombics, 2 log periodics, and 1 dipole antennas.

Greenville is partly responsible for coverage of Europe, the USSR, South America, and part of Africa, by direct broadcast. The 40 kw ISB transmitters broadcast program material to the VOA's European and African relay stations. Usually one sideband is program material and the other sideband carries RTTY. This is because Greenville is the main hub of the teletype network between Washington and the overseas sites.

Site C is the program distribution and receiver center. Here the programs are distributed to a designated transmitter after coming off the microwave link from Washington. In addition, there is a large antenna farm which is used for dual diversity (space diversity) with segmented audio reception of the BBC.

The VOA relays BBC programs into South and Latin America; in return, the BBC relays VOA programs from Ascension Island.

When talking to the station manager, Mr. Harmon, I found the answers to several questions about VOA operation:

Electricity for Greenville costs about \$3,000 per day, but, more importantly, their fuel adjustment charge has gone up as fast and as far as ours. In fact, this charge is almost \$25,000 per month in addition to the basic electricity cost. For this reason, broadcasting time was being cut. How much of this time was not known at the time I was there. I was told that the cut would be as large as necessary to get the station back on its budget.

The next thing I asked about was the VOA AM transmissions people have heard in the point-to-point bands. This is not true as the VOA does not use AM in the utility bands. At certain times on certain propagation paths the 40kw ISB transmitter cannot deliver a signal of high enough quality to the relay sites. When this happens, one of the broadcast transmitters are used. When this transmitter is used for relay, it utilizes the "Kahn compatible single sideband system". The Kahn adapter allows a regular AM transmitter to transmit a SSB signal with a vestigial carrier. It is this vestigial carrier that allows a receiver to demodulate the signal when the receiver is in the AM mode. It should be noted that by far the greatest majority of signal power lies in the SSB portion.

In summation I can say this about the Greenville site: the station personnel are very competent and really understand the business of International SW Broadcasting. Politics, interdepartmental and otherwise, is non-existent. An efficient cost reduction program is in effect so that more program hours can be used efficiently. In addition, they showed me every courtesy during my visit, no matter how busy they happened to be during the time I was there. I think we are very lucky to have such a dedicated group of people running this important international broadcasting operation.

USIA EXHIBITION: The U.S. Information Agency maintains a public exhibit tour at the headquarters of the Voice of America, on the second floor of 130 Independence Avenue, S.W., Washington, D.C.

During the free, guided tour, visitors watch broadcasts take place, see excerpts of USIA motion picture and TV programs, learn about Agency publications distributed in multiple languages around the world and of USIA's libraries, reading rooms and bi-national centers in other countries.

Forty-five minute tours are given at 9:00, 10:00 and 11:00 a.m., 1:00, 2:00, 3:00 and 4:00 p.m. Mondays - Fridays except on holidays. Groups of ten or more should make reservations in advance through USIA's Office of Public Information, Area code 202 755-4744.







Observations on a personal visit to



by

NASWA Traveller: Dan Robinson

## Trans World Radio

As many of you already probably know, TRANS WORLD RADIO - SWAZILAND, is now on the air from a transmitting site just outside of Manzini in that small land-locked country. Currently, TWR and Swazi Music Radio are the only stations on short wave from Swaziland. In this two part article, I will try to give you some idea of radio broadcasting in Swaziland as I experienced it this past summer.

It was an ordinary day in March or April of 1974, and I had just gone out (dashed out!) to fetch the day's mail. There was nothing there except the usual TWR news letter and envelope. But this news letter was different! It described the new stations which were under construction in Swaziland and Guam. After so many nights of futile listening for Swazi Music Radio, was I finally to have a chance to log Swaziland??? Little did I know that not only was I to have a chance to log Swaziland, but in four months from that moment I would be flying my way to Johannesburg, South Africa,



THE AUTHOR AT A LUNCH BREAK AT TWR SWAZILAND

on my way to Mbabane, Swaziland, for the most incredible 2½ months of my life. I suppose it has to be luck, but in the past two years I have travelled to the Soviet Union ( to visit Radio Moscow and Radio Kiev ), and to Southern Africa (visiting TWR, SMR, and the SAEC). This past summer I spent over two months living and working in Swaziland under the American Field Service.

My location in Swaziland for the better part of my stay was at a boarding school just outside of Mbabane, the small but very nice capital of this country. It was from here that I did my DX-ing and made my contacts for my first visit to TWR - Swaziland. The construction site is located outside of Manzini about 8 miles on a good paved road, and another 10 on a very rough and rocky dirt road with deep culverts and holes. It was easy to see where the bulldozers simply drove through the brush and trees to make the road. After a long, bumpy ride, we arrived at the station. I was accompanied by David Fisher, and several other people involved with the station. At the time of my visit, which was during the month of August, the site consisted mainly of the following:

1. The aluminum storage building which held all the equipment to be installed at the station was the main attraction. It held the transmitters as well.
2. There was a small building housing the diesel generators that will be used to supply power for the transmitters.
3. Besides these buildings, there were many small houses for the Swazi workers helping with the construction, a tool shed, and an office inside a trailer.

I wanted to make myself useful, so, amid the constant drone of the diesel generator, I went to work almost the moment I got there helping Dave (who is one of the station technicians, and now a good friend) string wires for the transmitter (made by GE) on a wooden model. Lunch was about 1:00, and after a full morning of stringing electrical wire I was ready to eat anything! At lunch time, there is always a devotional, when thanks are given for the safety of those working and those travelling, and also a reading from the Bible. Lunch is a nice break in the hard work that is necessary all day.

After lunch is over, work continues, and among the many activities going on during my three visits to the station were pouring concrete for the floors, making bricks for the walls of the transmitter and studio building, and conducting tests on the transmitter. Only one of the transmitters was actually working when I was there, but by now I assume the second one is about to be put into operation. On the last day I was at the site, the first omni-directional antenna went up with the help of all of us, and it was a sight to behold! While we were trying to hoist it up between two towers, a thunderstorm was passing overhead, and later it sent bright sparks of lightning dancing across the wires.

Helping with the construction were a group of Swazi men who take care of most of the really tough work like pushing wheel barrows of concrete to and from the transmitter building where the floors are being flattened and formed. They also make bricks, which is a whole other job in itself, and they deserve a lot of credit.

Most of the current frequency detail is now well publicized, and I have listed some of it in LN in FRENEX. I hope the illustrations with this article will give you some idea



VIEWS OF THE SITE WITH ANTENNAS ON THE FOREGROUND

transmitter will probably divide its time between the north antenna and the Cape Town vicinity antenna".

In my many conversations with people on the staff of TWR, it became clear that letter from SWL's and DX-ers will be welcomed, but until dedication on 4 December 1974 and during the first few months of operation I would not doubt that replies will be slightly longer in coming here.

In conclusion, I owe many thanks to the entire staff of TWR-Swaziland for their hospitality and help in writing this article (via a large amount of station information), and for frequency changes, technical information, and scheduling. For further flashes regarding TWR Swaziland, READ LN in FRENEX!

#### PART II: SWAZI MUSIC RADIO

Tucked back in the thick woodland of Swaziland amid pine and eucalyptus trees is the first radio station to offer a short wave voice of this small country in Southern Africa. When one lives in Swaziland for a while, he learns that where people say something is, does not necessarily mean that it is in that particular place. And, so the same with Swazi Music Radio. After over two and one half grueling hours crawling over dirt roads, rocks, streams, and ditches, I had my first look at the transmitting site of Swazi Music Radio.

As I have previously mentioned in LN, the site is situated almost directly on the border between South Africa and Swaziland - one can walk to South Africa if the fence lining the border were not there. As for the location itself, I could not think of a better location for a radio station. It is situated on the top of a small hill surrounded by other hilly country, but there are no really high mountains in the area and the antennas seem to have a lot of breathing room. There are five MW masts at a height of 173 feet, each forming lobes to Natal and the Transvaal for 1376 kHz. By now, there should be an additional antenna up at a height of about 140 feet for SW. Each MW antenna is actually what is called a "hot" antenna - in that it is a vertical half-wave dipole with

of the mammoth job it is to erect a radio station in the middle of Swazi bush country. There are five antenna masts scattered in close proximity to the buildings and these will be sending programs to Capetown, North to Malawi, and North-east to Angola.

The following information was received from David Fisher in Manzini:

"Our present operation is on 6070 from 0330 to 0700 GMT, extending to 0845 on Sunday. We are also on 6070 in German from 1615 to 1645. Then we operate on 3365 from 1655 to 2000 GMT. We are now using the Log Periodic Antennas, using the omni during most of the hours on the first transmitter. The second

copper mesh and a spark gap (for lightning), so I did not venture much nearer than necessary.

Stan Gobbi and his wife were very nice to me and to those with me and gave us a complete tour of the entire station and much technical information. Due to the isolation of the station, the Gobbi's spend much of their time at the station, and when visitors come, it is a welcomed, if not invasive, occasion. I had the opportunity to look at some letters sent by overseas DX-ers from countries like Sweden, Norway, England, and the U.S.A. There are three giant diesels for power and two giant 6000 gallon tanks for fuel to supply the generators. Twenty-four Swazis work at the site along with 2 Europeans and, of course, Stan and his wife.

Perhaps the high point of the visit was going into the transmitter room, where I saw the MW and SW transmitters - named "Mama", "Pipsqueak", and "Big Shorty". I believe the new 100kw transmitter was "Big Shorty" because it did not look large enough to handle 100kw. It was not yet in operation, but Stan said that it soon would be. To be exact, he told me that beginning in September or October (1974) the new 100kw transmitter would be put into service and programming would go to 18 hours a day. The frequencies can be found in the November (1974) issue of FRENDX, but as of November 30, the GATES transmitter that I saw at SMR is not in operation or else is just not coming across to the U.S. With that kind of power in that location, I cannot imagine why, but perhaps by the time you read this, SMR will be fairly well heard in North America. At any rate, the whole operation is extremely efficient and professional. Unfortunately, I have no black and white photos of the site, only color.

I hope all the above has made for interesting reading as it sure was a heckuva lot of fun being there in person!!

## Alexander Borell and Radio Luxembourg

The Los Angeles Times

**LUXEMBOURG** — "Do you have a problem? Do you need advice? Alexander Borell helps you."

Borell's deep, authoritative voice rings through the kitchens and across the highways of German-speaking Europe every Friday, as he publicly counsels five of the many distraught or neurotic people who write him each week. The 51-year-old author, jack-of-all-trades and amateur psychiatrist is the newest star of the liveliest and probably most profitable communications medium in Europe: Radio Luxembourg.

A privately owned operation, Radio Luxembourg is a rarity in a Europe dominated by state-controlled radio and television networks, virtually all of which pile up massive deficits. Compared to its bureaucracy-ridden rivals, Radio Luxembourg operates on a shoestring, beaming out a mixture of pop, chatter and dreary soap advertisements over the most powerful medium wave sender on the continent.

Rainer Holber, a refugee from the West German state radio and television network and the man who brought Borell, the "mailbox uncle," to Radio Luxembourg, is typical of the young, insouciant people who make the station a success.

"For every job here, there are 10 in the West German network," he said.

The accent is on pep and cheer with a delightful informality to Radio Luxembourg's programming. Newscasts can run 1 or 10 minutes, depending on news.

For the housewife, a steady stream of advice and information ranges from new recipes to beauty hints. For the driver, the program is peppered with the latest reports on weather conditions and — equally important — how to avoid the daily highway traffic jams.

Radio Luxembourg's service to motorists is so good it recently led to a government crisis in North Rhine-Westphalia, the biggest German state. Dissatisfied with the service put out by the state's own radio network, Interior Minister Willy Weyer offered Luxembourg full facilities in the state's traffic control center.

Political objections were raised and an angry debate took place in the state legislature. Weyer, a strong man in the Free Democratic Party, threatened to resign. Rather than see the government break up, the Social Democrats capitulated, and Radio Luxembourg is still reporting on traffic conditions directly from the control center.

Every summer, the station, as a special service for vacationers, broadcasts messages to tourists ranging as far from home as Yugoslavia and Spain, urging them to contact home or office because of emergencies. Usually included are a description of the car and the license number so motorists who are listening can alert others to emergencies.

Such services give it a massive audience. Borell's listeners every Friday morning are estimated at 2 million. And Radio Luxembourg also broadcasts in French, English, Flemish and Italian.

Radio Luxembourg first went on the air in 1935, when a backyard tinkerer named Mathias Felten put together the first small transmitter and began broadcasting. Today, it operates from a park in downtown Luxembourg, in an ancient stone tower which was once the powder magazine for the city's medieval fortifications. Felten, now an elderly patriarch, is still its director general.

Its popular appeal can be understood best in the context of the deadly dull programming of Europe's state-run communications media. Nothing illustrates this better than a current controversy over advertising in football stadiums.

Borell is no learned psychiatrist, but nonetheless considers himself ideally qualified for his job as "life adviser." His father was a stiff Prussian officer, his

mother only a servant of her man, and he left home at 18.

Since then, he has been a racing car driver, a zoo keeper, a production line worker and an author of several dozen novels, some of his novels are detective stories based in Los Angeles, a city he has never visited.

He has been married four times, the last time for 22 years.

He writes advice columns for five magazines, three of them under female pseudonyms, and has unbridled contempt for the run-of-the-mill professional psychiatrist.

"You can't learn about life from books," he said. "Too many psychiatrists are disturbed people themselves."

Watertown Daily  
Times (Jan. 14, 75).

VIA  
Bill Quinn  
Box 21  
Moirs, N.Y. 12957



ADD SHORTWAVE TO YOUR CAR RADIO  
and drive around the world as  
you drive to work!!!!

A NASWA EXCLUSIVE REVIEW by

Dennis Patrick Driscoll

When you drive to work in the morning does your body start to twitch and a pain shoot into your gut? If so, you are just one more radio junkie going through DX withdrawal. It happens everytime that you part company with your receiver for longer than five minutes. Once you have tasted DX you will never be the same again. You just can't get enough of that shortwave radio.

Are your families just about ready to sign your commitment papers to the funny farm because of your all-night SWL'ing? Or because of that night when you almost axe murdered the neighbor who started running his '57 Chevy just as you heard a conch shell IS on 5045? Well, convince them that you are totally bananas. Install a Becker Reims Short Wave Adapter (Model #10) in your car. Cruise the town to the strains of R. Moscow, R. Habana, or even HCJB! The folks will have you crated off to the nut house in no time flat. How could anyone who listens to short wave every waking moment be sane? They just don't understand the cravings of a radio junkie!

Dan Henderson's fantastic "Travel Log" article in the January 1975 FRENDX was only half of the traveling DX story. Why wait until you arrive at your destination? Why not listen to short wave while on the road? If your ears hurt because of the fast talking DJ's on AM and the Muzak on FM, install a shortwave adapter and find real variety in radio.

The Becker Reims Shortwave Adapter is a ten band, solid state converter that can connect to any AM car radio. It covers the 90, 75, 60, 49, 41, 31, 25, 19, 16 and 13 meter bands. It can run on 6 or 12 volts, negative or positive ground. The unit is 1 1/2" tall, 7" wide, and 4" deep. It weighs 34 ounces. It has eleven push buttons (one on/off switch and ten band selector switches) for easy operation. The price is \$61.24 (this includes mounting hardware, connection cables, and a six month warranty). It can be ordered directly from: Becker AutoRadio, USA, Inc., 613-19 South 24th Street, Philadelphia, Pa., 19146. If you pay with a certified check or money order, the unit will be shipped immediately upon receipt of the order. (I ordered mine on a Wednesday and received it via UPS on the following Tuesday). Becker provides prompt and courteous service.

Installation is a dream. The unit can be mounted either under the dash or in the glove compartment. I chose the latter to keep it out of sight of theives. The signal from the antenna is run directly into the Adapter. When the Adapter is switched off the signal bypasses the Adapter and allows normal AM reception. This is accomplished by a short cable connected between the Adapter and the AM radio jack. The only other connections are the power and ground. These two are quite simple, as they can be hooked to the existing power/ground connections on the AM radio. All instructions for installation (including diagrams) are included along with the necessary equipment. Becker, as you may know, is the German company that makes radios for the Mercedes-Benz automobile company. Their quality is very excellent.

### Reims ShortWave Adapter, Model 10



Tuning of the Adapter (to match it to the antenna and the AM radio) is accomplished by the adjustment of two screws. One is the output trimmer and the other is the antenna trimmer. First, trim the antenna on the AM band. Then, trim the output trimmer and the antenna trimmer with the Adapter on the middle of the 41 meter band. These simply adjust the signal and unit to peak. Longer tuning instructions are supplied with the Adapter, but these are for the rejuvenation of an old Adapter...not for the simple tuning adjustment required by a new Adapter.

Operation of the Adapter is quite like selecting radio stations with the push buttons on most AM car radios...Once the AM radio is turned on, simply depress one of the buttons on the Adapter to select a short wave band. Then tune the SW band on the AM radio dial just as one would normally tune. Only one thing to get used to when using the Adapter: it tunes backwards! Most radios increase in frequency as you dial right-to-left. The Adapter decreases in frequency. Example: If, on the 31 meter band, WWV (10 MHz) shows up at 700 kHz on the AM dial, then Radio Cairo (9805 kHz) will be at about 900 kHz on the dial. If you remember this one fact, finding stations will be no problem. The 200 kHz spread on the AM dial will still mean a 200 kHz spread when tuning shortwave. (You can use your present receiver to determine the exact frequencies of stations heard in the car and then make calibration charts. This will allow you to obtain good calibration of your car radio).

Reception has been quite good with the Adapter. All of the super power stations offer "clear channel" reception. Stations with about 50 - 250 kW power are obviously no problem; 10 - 50 kW stations are very good but not as booming as their big brothers. This is true of all short wave radios, so it is nothing new. There are more audible stations in the car than one may think. In the one week that I've owned the Adapter, I've also heard a number of good 60 m.b. catches. These include Togo on 5047 and Turks Island (VSI8) on 4788. It was quite a strange feeling to hear these while driving around town!!! This is not a unit restricted to receiving the VOA and CBC. The sensitivity is greatly improved over earlier Becker models. It is comparable in quality to many good shortwave receivers. I have made simultaneous comparison tests between the Adapter in my car (using the regular AM car radio antenna) and a Drake SPR-4 (using a Musch 86-D dipole antenna). Obviously, the SPR4 far outweighs the Adapter in selectivity, but I was quite impressed with the sensitivity of the Adapter. There have been a number of stations whose signal was stronger in the car! Yet, crowding is quite apparent on the Adapter bands.

If you are indeed tired of AM radio or can't get enough of shortwave --- try the Becker Reims Short Wave Adapter (Model #10) for added listening enjoyment. At the very least you can scare the h--- out of hitch hikers when they jump into your car and hear Radio Moscow booming away.

73's, and keep your eye on the road!

#####

## REPORTER'S JOURNAL

YES, WE NEED A NAME

by

Morgan Monroe

When Ed Shaw took off for the Pacific, he left me the assignment of reporting suggestions and comment stemming from the December FRENDC article: Do We Need A Name? Response hasn't been heavy, but among replies are some thought-stimulating comments.

Carl Rozycki, Patchogue, NY, agrees that our hobby urgently needs a name, but believes that "the priority is not identification, but survival". In expressing his concern, Carl employs this formula: "No listeners identified as a group = less transmissions; less transmissions = less receivers; less and less receivers = fewer members of NASWA (or any other group); eventually: zero". His name nomination is: "World Radio Communications Monitor".

Jimmy C. Jones, Nashville, TN, shares Carl's concern for the hobby's future and thinks a "generally acceptable name" would aid in spurring greater public recognition and participation. "There's strength in numbers," reminds Jimmy. "Witness government and public participation and encouragement of the hobby in Scandinavian countries where it is enjoyed by a much larger percentage of the population." He believes the term "International Radio" could stand alone once it is understood and accepted.

Lawson Booker, Columbus, OH, came up with four name nominations. They are: "Radio Transmission Monitor", "Foreign Broadcast Monitor", "Radio Communications Monitor", and (hang on!) "International Radio Communicologist". (SWC ed note: the last title would evenly encompass LW, MW, SW, UTE, ARO, etc., Dexters quite well!)

R. A. MacLeod, Erie, PA, feels a suitable name should extend beyond the international concept. "We also monitor such things as ships at sea, aircraft, and even space craft," he writes, suggesting as his candidate: "Universal Broadcast Monitors".

A. L. Garrou, Valoese, NC, proposes "Worldwide Radio Monitor" and the acronym "WORM". He explains that the acronym "has a catchy touch to it and is easy to say". (SWC: yep!)

Several members thoughtfully sent along their endorsements of my "International Radio Monitoring" suggestion. They are Mrs. M.M. "Grandma" Greene, Bell CA; Carroll R. "Pat" Patterson, Decatur GA; L.P. Benjamin, Lompoc, CA; and Ken Earhart, Allentown, PA.

So, we have a total of 10 name possibilities including "International Radio Enjoying". Considering NASWA's size, that's not many. But it's a beginning - one that could at last lead to a descriptive identifying name for our hobby. All who wrote agree that we do, indeed, need a name.

But unless NASWA's full organizational weight is placed solidly behind this need, it may be filled by others. QUESTION: Shall we meet this challenge or sit on the bench while some other organization picks up the ball and scores? What do you think? Drop me an 8¢ postcard with a brief summary of your ideas and thoughts on the matter. Morgan Monroe, 1225 Pine Street, Sandpoint, Idaho, 83864, USA.

#####

## portfolio

- The grand daddy of all DX shows was started in 19 September 1922 over
- WBAY-AM New York. The ATT station broadcast between 1630-1730 and known as "The Radio Digest". Hosted by George F. Thompson, it was mainly a
- news show, but questions from listeners about radio were read and QSL'd.

# Receiver Construction

## is ready when you are.

by Bill Davis with a little encouragement from Werner Selby

Why would anyone in their right mind undertake a project like building his own "Communications Receiver"? Receivers of almost any size and shape, with an assortment of desirable operating features are available commercially in a number of price ranges. Almost any feature you want is available somewhere. The rub comes when you start combining desired features for the receiver YOU want. As you add to your list of features, the field of choice becomes smaller and smaller, until one last feature drops them all out of the picture, and the only way to get the receiver you want is to really design it and build it yourself. That is what happened in my case. As a second benefit, the price is lower in cash, although the man-hours to accomplish what I wanted make me wonder:

What features make this receiver difficult to duplicate? First, plug-in ganged coil assemblies, as in the National HRO. They have inconveniences, but any one who has ever seen what a high "Q" antenna coil in a good shield will do for a receiver signal-to-noise ratio above 10 mHz will think long before he packs a receiver full of bandswitch and coils.

Next, remember the old Hammarlund Super-Pro with the variable coupling I-F transformer which gave continuously variable selectivity, controlled from the front panel? I wanted that, too, as well as double conversion (for image response reductions), a "hole pusher" type noise silencer, A.G.C. which worked for telephone or code reception, a built in crystal calibrator, and enough audio to sound fairly good when signals justified its use.



The block diagram at the end of this article shows what finally evolved from my requirements, and the photo (above) shows the general appearance of the 90 pound monster which finally took shape.

The National "PW" dial gives a 12 foot scale length for calibration; used HRO and HRO Jr coil sets, retracked for the 2747.5 kHz first I-F, provides high Q plug-in coils for complete general coverage, and bandspread sets if desired. The first I-F feeds the second mixer and a 3010 kHz crystal oscillator yields the second I-F of 262.5 kHz. A crystal filter provides added selectivity, but is mostly used for its rejection notch to remove heterodynes. This is followed by four stages of gain at 262.5 kHz. The agc is taken off before the detector, so is usable for cw and as well as phone.

One stage of audio gain and a cathode follower feed the headphone jack, a jack for the tape recorder and a phase inverter which drives two triode connected 6V6GT's in the push-pull for good loudspeaker volume.

The "hole-puncher" noise silencer is in the first I-F and the amplified noise pulse is used to turn off a buffer amplifier between the 3010 kHz crystal oscillator and the second mixer. A little unconventional, but it works.

Also included is a 100 kHz crystal calibrator controlled by a panel switch. With a vernier index on the dial, it provides calibration to about 2 kHz at 20 mHz from the dial readout which is adequate for most needs.

The variable coupling 262.5 kHz I-F transformer were built at home, too, using Miller coils, air dielectric trimmers and lots of elbow grease.

The use of octal tubes may surprise some, but looking back on the service record of tube replacements I think it was a good choice. The tuner uses miniature tubes for short leads and low electron transit times, which are important above about 10 mHz, but few of them seem to last more than a year or so, while many of the octal tubes have been in the same old socket for over five years.

The final results have borne out my hopes and expectations. Good sensitivity, excellent selectivity - I only hear an image response about once a year, and it is reliable and easy to use.

Now, for the \$64 question: Would I recommend you building your own receiver? Well, yes and no. If you know enough electronics to do the necessary design work, are enough of a craftsman to convert the design to good hardware and can't find what you really want on the market - yes.

Otherwise: NO!!

-o-

Werner J. Selby lives not too far from Bill Davis and sometime ago went over to his house to check out the receiver himself, as he was curious to know more about a "homebrew" that he kept seeing after Bill's name in the Log Report columns. A little polite arm twisting and we see the results of Bill's handywork. Werner says, "Nothing against a Drake SPR-4...but...we hooked up my Drake which I brought along, at his antenna - - what an embarrassment! Not only was there hardly any receiver noise on his "homebrew" but the stations came also in much stronger and his 'S' meter was far more sensitive than mine." Thanks to both Bill and Werner for providing NASWA with an item of top-notch interest!

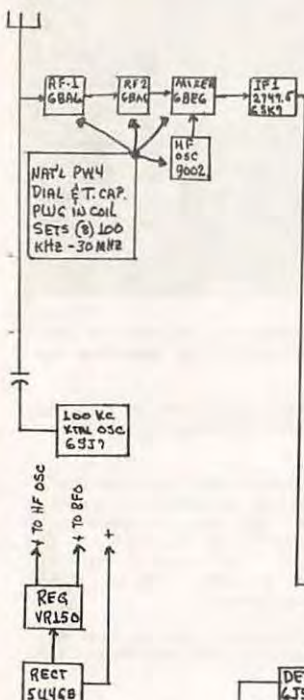

BILL DAVIS of CALIFORNIA

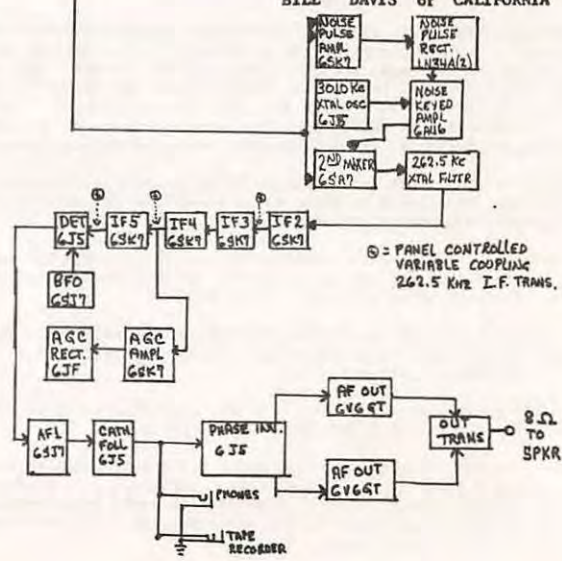

# QSL REPORT



RT

EDITOR:

BOB ZABOT  
POB 62659  
VIRGINIA BEACH  
VIRGINIA 23462

DEADLINE  
10th of the month

SAUTI YA TANZANIA



APRIL 1975

Well we are moving very rapidly out of the DX "season" and into the spring and summer. Hopefully many of you will be receiving cards and letters from all the reports that were sent out the past few months.

## QSL's FOR

- AFAR & ISSAA: ORTF, 4780 Folder c in 2ld air for 3 IRC, pc, FF rpt, used US stamps (REEVES) 4780, Djibouti in 15d, air for 2 IRC & FF rpt (Mayer)
- ANGOLA: R Clube Do Mexico, 5192, topless native woman ppc w/veri statemanonly in 19d air for EE rpt & 1 IRC (Mayer)
- ANTARCTICA: AFAN, 6812, stenciled lttr, seammil in 8w, according to ARDXC QSL Survey only 5 QSLs recd by Australian DXers even though reception is common here (Padula) same in 1m air (Field) same in 9w air (Zabot)
- AUSTRALIA: RA, 5995, 6005, 9540, 9570, 11810, 12930, 15355, 15425 various c no rp from lhd to 120d (Barto, A. Howell, McCarthy, MacLeod, Mayer, Padula)
- AUSTRIA: Vienna, separte cds for 9710, 11945, 7170, 7105, & 7205 in 2-6w air & 1mas cds, sked, & rpt forms (Padula)
- AZAD KASHMIR: AER, 4915v, FD lttr sked in 3 wk registered for Urdu rpt, pc, 3 IRC EE reply. v/s M Sajjid Sli Siddiqui, Eng Mgr for station Dir, envelope sealed w/wax seal (Reeves)
- BELGIUM: Brussels, 17740 15205, 2 c & sked sea in 10w (Padula)
- BOLIVIA: R Centenario, 4855, personal lttr, 1mas c, in 1m on 3rd try for SASE (M Field)  
R Panamericana, 6035, lttr in 18d from Jamie Vasquez de la B "co-ordinator" (Dexter)  
R Movima, 4467, lttr & photos in 2m. V/s Edger Vaca Dierz J Dir (Dexter)
- BOTSWANA: RB 4845 Elephant c in 8m for EE rpt/2 IRC (Lay)
- BOUGAINVILLE IS: ????? c w/freq & time of entire bc in 3w air v/s Alfred Edoni (Sgrulletta) what station? what freq? ed.
- BRASIL: R Cairal, 4785, PP lttr in 6w 3rd try air for sase (M Field)  
R Jornal do Brasil, 4875, c in PP & EE in 5w for PP rpt 6ms (Barto)  
R Poti, 4935, lttr in 5w for PP rpt & ms v/s Cesar Rizzo, dir programacao (Barto)
- BULGARIA: R Sofia 9700 FD c sked forms in 5pm 1 IRC #1 (T Fields)
- CANADA: CBC, 11720 northern service c in 26d air (Wiles)  
CFRX, 6070, carnival c w/FD sked in lhd air (Morits)  
CHMX, 6130, e/FD sked in 13d for rp (Morits)
- CHAD: R Nat, Tchad: 4904q e7FD & sked in 20d for FF rpt & ms (Driscoll) same in 4m on 2nd try c shows 3 pix of Africa (Sgrulletta)
- CHILE: LV de Chile, 9560, FD casino c in 65d air for EE rpt & 2 IRC, (Brunner) 11810 colored c & sked air in 15w for EE rpt & 1 IRC (Padula) 15150e & sked in 6w air for EE rpt (Padula) 15150 pe in 2m air no rp (Criswell)
- COLUMBIA: LV del Anarueo, 4865, lttr SS, pc, rate sheet in 6w 5th try, v/s Garrad Muns Tello, Ger (M Field)  
R Nacional 4955, Manisales c w/no details except lttr date in 12d airm ms (Slaff)  
Ecos del Strato, 4955 lttr air 1m after f/up from Edis Nauffall Dualiby (Dexter)  
Ecos del Atrato, lttr air in 1m sase, v/s same as above. lttr states freq as 50L6 as been off sw 2km because chief stole 3 RCA 833 tubes. which are difficult to obtain in Col. & would appreciate assistance from US (M Field)  
R Nacional, 6030, HJCT, 1m, v/s German Vargas Dir (Barto)

COSTA RICA: R Casino, 5954, long green c /FD in 6m air for ms (Paschke) 6107, c in 3w 2nd try (M Field)  
 TIPC, 9645, c in 10d air for 3 IRC (Criswell)  
 CUBA: R Havana, 9525, c in 66d w/3 IRC also books, newspaper, sked (Wiles) 11875 c & sked air in 11w (Padula)  
 DENMARK: RD, 15165, c in 28d for EE rpt 7 l IRC (McCarthy)  
 DOMINICAN REPUBLIC: RTV Dominicana, 9505, SS lttr no date in 40d for SS prt & 2 IRC (Brunner)  
 R Clarin, 4850, SS lttr & pennant for SS rpt 22d for ms v/s Lilly Morales (Slaff)  
 SS lttr in 11hd for SS rpt & 1 IRC (McCarthy)  
 CZECHOSLOVAKIA: R Prague, 5930, c/FD 1m for 1 IRC (Morits) 15130 Zvikow castle e in 11 w sea (Padula)  
 ECUADOR: R Iris, 3350, lttr in 24d for SS rpt & ms, pennant v/s Klara Marcial (Barto)  
 R Centro, 3515, lttr, photos v/s Artura Encalad Peratta in 7w regis. (Dexter)  
 R Pas Y Bien, 4820, c & per. lttr, 1mas c, in 3w for SS rpt & ms (Barto)  
 Emisoras Gran Colombia, 4910, lttr & pennant in 3w for SS rpt & ms (Barto)  
 R Quito, 4923, c in 1m for SS rpt & ms, also Pennant (Barto)  
 R Splendit, 5025, lttr, pennants from Edmundo Valencia 3w (Dexter)  
 R Nacional Espejo, 5044, lttr 3" tape in 5m 4th try by air (M Field)  
 HCJB, 5970, 9560 various c from 20d to 40d (Slaff, Paschke, Marshall, Wiles, Howell)

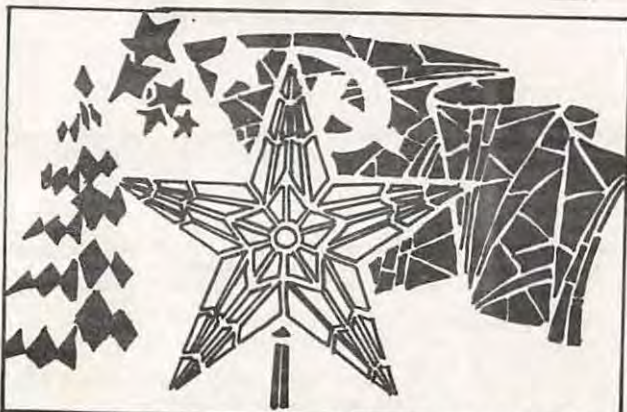

С НОВЫМ ГОДОМ!

ENGLAND: CBC Daventry, c from Montreal air in 1w 61h5 (Padula)  
 VOA Woolferton, 6080, in 7d EE rpt (McCarthy)  
 EGYPT: R Cairo, 9475, c sked in 34d no rp (Brandt)  
 FINLAND: R Finland 15185 c lttr sked ante:na sheet in 1m for 1 IRC (Morits) winter e in 20d air for 1 IRC (Rockwood) same in 12d (Brandt)  
 FRANCE: CRTF 15120, 15160, 15300 c & lttr from 1hd to 95d for up to 2 IRC (Cole, Wiles McCarthy)  
 GABON: RTVgabonaise 4777, c/FD air in 4hd for FF rpt & postage stamps (Paschke)  
 GERMANY D: DW 6040, 11880 c from 5 to 10m air (Padula, Criswell, Quinn)  
 GREECE: VOA KAVALA 11840, c sked in 11d no rp (Brandt)  
 GRENADA: RG, 5015, c in 20d for 2 IRC (Brandt) after 5 repts 45d for 4 IRC v/s C. A. Alexis QTH poB 34 St Georges Genada (Earhart)  
 GUAYMALA: R Maya, 2360/3325 c/each freq. in 10d air v/s Loran Veith by air (M Field)  
 GUYANA: Action R, 3290 fm lttr FD in 15d for 2 IRC (Brandt)  
 HOLLAND: RN 15185, air in 4w w/new style c (Padula) 21745 c in 2w (Padula)  
 HONDURAS: LA Vos dal Junco 6075, nice c in 15d air for ms, pc, SS rpt v/s A.S. Hasbun whed me 73 (Reeves)  
 HUNGARY: Budapest 7220 c shows tradional costumes in 10w; 9630 & 9655 separate cards sea in 10w (Padula)  
 ICELAND: Voice of Iceland, 12175, pc in 450d for 3 IRC (Earhart) map card in 395 d (M Marshall) same after f/up in 365d total time for ms (Driscoll)  
 INDIA: AIR4775, lttr in 5w air for 2 IRC v/s P P Lal via Dan Hendersons penpal at this station (Reeves) 9912 c for no rp in 18hd by air (T Smith)  
 INDONESIA: IDH-2, 3925, Semarang 6w for II rpt v/s Rachmat Bosowoeharto (Barto)  
 RRI Pekanbaru 5854, lttr photo of annc 3w after several f/ups (Dexter)  
 IRAN: Tehran home service 7044 long c w/FD air in 6w (Padula)  
 TvoI 9745 c & pennant in 27d no rp (Brandt)

ISREL: IBA 7395, c in FF for EE rpt in 56d no rp (Slaff) 17690 c in 13m for 1 IRC (T Field)  
 IVORY COAST R Abidjan 11920 c/FD in 18d air for 1 IRC (Cole)  
 JAPAN: MHK 5990, 5995, 11725, 15105, 152701 15430 various c from 12 to 30d (Padula, Wiles Criswell, Paschke, Marshall, Howell)

STATION DE DJIBOUTI

RADIO DIFFUSION

Nos émissions sont diffusées chaque jour, sur deux chaînes, en quatre langues  
 Français - Afar - Issa - Arabe, sur les fréquences suivantes

Fréqenc. en KHZ	Longueur d'onde en M	Puiss. en KW	Horaire des émissions en h GMT		Bulletins d'informations (en heures GMT)
			En semaine	Dimanches/Fêtes	
<b>CHAINE FRANÇAISE:</b>					
1169	256	4	03h 20 à 19h 30	05h 00 à 19h 30	Français: 04 h 00 - 10 h 00 - 17 h 00 Afar 03 h 45 - 11 h 00 - 18 h 00
<b>CHAINE LOCALE:</b>					
1538	195	4	03h 00 à 06h 00		Issa: 04 h 15 - 10 h 00 - 17 h 00
4780	62,76	4	09h 00 à 20h 00	05h 00 à 20h 00	Arabe: 5 h 15 - 15 h 00

TELEVISION

CANAL K'5 — Programmes de 15 h 15 à 20 h 00 tous les jours  
 sauf mercredi: 14 h 45 - 20 h 00 et samedis, dimanches et fêtes: 13 h 15 à 20 h 00  
 \*ournaux télévisés en Français, Afar, Issa, Arabe - de 15 h 30 à 17 h 30 GMT

KAZAKH SSR: Ltr from R Moscow states that they will not verify programs in Russian or native language from Soviet Cities (M Smith)  
 MADAGASCAR: RN 11730 c sked fact sheet in 49d (Brandt) 28d (Slaff) 18d (Rockwood)  
 MALAGASY REP: RN 17780 c air in 2 weeks (Padula)  
 MALAYSIA: R Malaysia 4845 FD folder c in 117d air foe EE rpt & 1 IRC (Mayer)  
 MALI: RM, 5995 FD yellow/brown/white/black c map of africa in 2m on 4th try. total of 4 IRC & FF rpt (Earhart) same in 24d air for FF rpt & 1 IRC (Mayer) same in 104d for EE rpt & 1 IRC f/up (M Smith)  
 MALTA: CBC, 6100, c in 1m (Earhart) same by air in 4 w (Padula)  
 W. DW, cd in 5 m for 2 IRC (Reeves) c w/site in 1m (Sgrulletta)  
 MAURITANIA: RM, 4845 FD green/yellow/white/black c in 140d sea 7 FF rpt (Mayer) 4845 & 4850 cards in 30d & 20m for FF rpts & f/ups (Driscoll)  
 MEXICO: XERMX, RM 15125, FD ltr sked pennant in 150d air 1 IRC (Rockwood)  
 MORROCCO: VOA 7220, c sked in 6d no rp (Brandt)  
 NETHERLAND ANTILLES: TWR 6045 c/FD & sked in 86d (Slaff)  
 R Netherland relay, 17810, 17830, c/in 20d (McCarthy)  
 NEW CALEDONIA: RN 7170, usu c in 2w for EE rpt & 2 IRC (Lay)  
 NEW GUINEA: R Wewak, ltr air in 1m for tape rpt w/ms v/s Phillip Kovirono (Sgrulletta)  
 NEW ZEALAND: NZBC, 11780 fm ltr in 49d (Brandt) 9540 ltr in 44d air for 1 IRC & EE rpt - QTH Box 98, Wellington NZ (Howell)  
 NICARAGUA: YNRG 5955, R Zelaya c in 3 w for SS rpt & ms v/s Ray A Golppo (Barto)  
 NIGER: ORTN Niamey, 5020, Oocra map c giving time date and sked on back. for FF rpt and 3 IRC in 30d (Michalenska)  
 NIGERIA: NBC Lagos, 7275, sked in 26d no rp (Brandt)  
 NBC Maiduguri 49000 ltr in 1m for a 72 rpt v/s N E Alouby Eng (Barto)  
 NORWAY: RN 6180, 15175 logger c in 1m air (Slaff, Rockwood)  
 PAPUA?: R Kerema, 3245 mimeo ltr in 1m v/s a. Nase, stn agr (Dexter)

OSLO 9/10 19 74

DEAR LISTENER,  
 WE THANK YOU FOR  
 YOUR REPORT AND ARE  
 PLEASED TO CONFIRM  
 THAT YOU HAVE HEARD



**NORSK  
 RIKSRINGKASTING**

RADIO NORWAY

ON 15175 KHZ 19-77 MJ 120 KW  
 CALL LETTERS LLM ON 29/9 19 74

SINCERELY YOURS  
*Teleg. Thore*  
 SHORT WAVE DIVISION

1600 GMT

17

PAKISTAN: PBC, 7085, ppc w/FD in 50d for ms (Earhart) 4751 & 6230, cards for 3 IRC in 40d (Reeves)  
 PERU: Quillabamba, 5025, SS ltr & pennant in 1m air for ms v/s Joaquin Barriales (Earhart)  
 PORTUGAL: RP 6025, 9670, 15295, 21495 c stickers sked (Barto, Slaff, T Field Padula)  
 REUNION IS: Now France-Regions-Trois station de la Reunions (Centre BF 97405 St Denis) not ORTF sent form ltr w/FP in 19w (8w after f/up) for taped rpt & ms. v/s R. Carrie (Sgrulletta)  
 ROMANIA: R Bucharest 9570 c & sked in 2m (Cole)

RWANDA: DW, 9700, card in 17d no rp (Earhart) 15380 c in 330d (M Smith)  
 RYUKTU IS: VOA, 7165 card in 10d no rp (Brandt)  
 SAUDI ARABIA: 21460, c & ltr in 44d air for EE rpt & 1 IRC (M Smith) 6620, cd & sked registered air in 6w (Padula) 9620 not 6620 my mistake ed

Note: Valdersbunder.  
 Norway: Local customs from  
 the Valders district.  
 Foto: Normann, 70-13.  
 at.

APRIL 1975

QSL REPORT 4

FRENCH

SARAWAK: RM, 5005 for rpt on the Sibo Ex the site not listed on card in 6w (Dexter)

SEYCHELLES: FEBA 11865, 11785, 15160 separate c air & religious material in 4-5 w for 2 IRC with each rpt. Also 9605 c air in 6w for 2 IRC this freq only noted on days when E propagation mode around local noon is operative and rare (Padula) 11785 FD c sked in 42d for 3 IRC (Rockwood)

SIERRA LEONE: SLBC 3316, FD ltr in 2m for 2 IRC v/s H. Pele Roberts Eng (Lay)

SOMALI REPUBLIC: R Mogadushu, 6097, FD c in 37d for EE rpt 1 IRC v/s M M Afrah. he requests used stamps (Mayer)

SPAIN: RNE 15420 15145, 11775 cards in 3w (Barto)

SPANISH SAHARA: El Aaiun, 11805 large Qsl c w/text in SS v/s Pablo Ignacio de Dalmaes also sent copy of current station n ltr in SS and promised to send a book about the country air in 12d for 4 IRC and SS rpt. Not new to me but a nice interesting QSL all the same (Padula) 11805 all above in 11d and a book for 1 IRC (Mayer) 7230, cd and sked in 1m for SS rpt & ms (Barto)

SOUTH AFRICA: RSA 5980, 9525, 11900, 15155 c in 20 to 30d (Dean, Howell, Marshall, Slaff)

SRI LANKA: SLBC, 11800 no date ltr and sked in 18d for 1 IRC (Rockwood)

SWAZILAND: TWR FD c sked in 21d no rp (Reeves) 6070, c in 32d air for EE rpt for 1 IRC (Mayer)

SWEDEN: RS, 9630 c in 2w (Barto) 11755 c air in 6m (Padula)

SWITZERLAND: SBC, 17830, 11720, 15430 15140, 9535 all in 1m (Barto)

SYRIA: FD c in 6m for 2 IRC (Reeves)

TAHITI: L5170, cartoon c in 90d (Quinn)

TOGO: RT, 5047, c in 27d for EE rpt and 1 IRC (Word) same in 35d (McCarthy)

TURKEY: VOT, 11880, c in 30d (Brandt)

TURNS & CAICOS IS: 4788, mimeo veri in 25 d for 3 IRC air. v/s W. G. Grand (Cress) ltr in 15d for EE rpt (McCarthy)

USA:

AFRTS, Delano 9700 c in 11d air (Howell)

AFRTS, Greenville 11790 a in 20d (Slaff)

KOEI, 11905 c sked in 1m (T Fields)

UN, Bethany 11850 c sea in 10w (Padula)

UN, Bethany 11860 c sea in 10w (Padula)

UN, Dixon 9555 c sea in 18w (Padula)

UN, Dixon 9660 c sea in 10w (Padula)

VOA Greenville 5995 c in 20d (Howell)

WYFR 6065, 9715, 11805, 15140 FD cards sked 14 to 21d (Brandt, Padula, Moritz, Slaff)

USSR:

R Kiev 5910 c in 58d air (Slaff)

R Kiev 7200 c sked in 45d (Brandt)

RM, 7160, FD c in 43d air (wiles) 1 IRC

R Vilnius Q 9735 card and nice pc folder sea in 10 w (Padula)

VATICAN: VR, 6165, 7235, 9615, c & sked fr 21 to 31d (Barto, Brandt, Rockwood)

VENEZUELA:

R Carupano, 3305 pc air 10w 4th try (Field)

R Puerto La Cruz, 3365, SS ltr in 24 M for ms v/s D R de Alcalá (Dean)

R Lara, 4800 c in 44d for SS rpt & used stamps (McCarthy)

R Valera, 4840, c in 26d for SS rpt & ms v/s Carlos Julio Balza (Barto)

R Los Andes, 6010, Dmas c as response to report no data in 2m 4th try c/s Globo (Field)

YEMEN: PR, 7190, FD c in 4m air for 3 IRC & EE rpt v/s R M Ahmed (Lay)

YUGOSLAVIA: R Beograd, 15240, FD c sked on 30 d for 2 IRC (Brunner)

WINDWARD IS: R Gernada 5015 c in 62d for EE rpt & 1 IRC (McCarthy)



OFFICE DE RADIO-TELEVISION FRANÇAISE  
RADIO TAHITI ÉCOUTE POSTALE 425  
PAPEETE

## CONTRIBUTORS FOR MARCH

Tony FIELDS, MI  
Sam BARTO, CT  
Ken EARHART, PA  
Bob WILES, WVA  
J COLE CO  
Neal FERDUE, TN  
Myron SMITH NY  
Henry MICHALENKA RI  
John MORITZ Jr OH  
Austin HOWELL BC  
Scott REEVES MD  
John SGRULLETTA NY  
Marlin FIELD MI  
Deanis DRISCOLL NC

Mildred MARSHALL ND  
Gerry DEXTER WI  
Todd SMITH CT  
Henry ROCKWOOD OH  
Kerryn BRANDT NY  
Dan MCCARTHY IN  
Bill PASCHKE WI  
Alan MAYER IL  
Charles BRUNNER PA  
Bob PADULA Australia  
Dennis DEAN OH  
Jerry WOED GO  
Bob CRISWELL TX  
Dan HENDERSON MD

Jerry Slaff NY  
R A MACLEOD PA  
Russel LAY VA  
Hadley CRESS VA  
Bob ZABOT VA  
Jeff POWERS PA  
Bill QUINN NY



# LISTENER'S



**ANGOLA** RC de Angola Dan Jamison  
is hrd occasionally 4491-F Lakeside South  
on 9630 at 0700 + Columbus, OH 43227  
w/guitar and vocal 614-861-1125  
mx. W/a good Afro  
opening, this is an  
easy Angolan logging. Deadline: 15th  
What out! R. Nac -  
Portugal is also on  
this freq, but not sked'led at this time.  
(this from Dan Robinson, PA)

**AUSTRALIA** The NA Svc fm RA is b/c fm 0100-0300  
on 15320 and 17795 Khz. The morning xnsms is b/c  
fm 1115-1315 on 9580.

(via Henry DuRant, Thailand; Glenn Hauser, OK)

Radio Australia may also be hrd testing fm their Nangara site which is  
located near Perth. Nangara beams to Indonesia fm 0100-0400 on 17895;  
0400-0900 on 21745; 0900-1200 on 15445; 1200-1500 on 9765...to the UK  
fm 0700-1200 on 17885; 1600-2000 on 9720. (via DX'er Glenn Hauser, OK)

**BANGLADESH** EE fm R Bangladesh to Europe may be hrd fm 1815-1915 on 5825  
// to 7370. The HS is now on 4780, vice 7285; also check them out  
fm 0030-0213 on 4890. From 0600-0930, look for them on 7230 and 6008,  
vice 9550 and 7285. (by permission, BBC Monitoring SVC)

**BRAZIL** Do you wonder why you have not received that QSL card from  
R Nac de Brasilia for that detailed rpt you sent? Charlie Brunner, PA,  
has the answer for us. Charlie said that he was informed by the  
Director of the International Svc that many reports are mis-sent to  
R Nac de Rio de Janeiro! How about them apples gang. You might try using  
the address appearing in Gerry Dexter's SWL ADDRESS BOOK for your next  
rpt, that's what Charlie did.

## Radio Canada International

(via Glenn Hauser, OK; Bob Underdown, AK; David Snyder, NY)

United States / États-Unis			
0100-0157	ENGLISH/ANGLAIS	9655	8085
0200-0257	FRENCH/FRANCAIS	6020	
0400-0500	ENGLISH/ANGLAIS	9655	8135
0500-0600	ENGLISH/ANGLAIS	9655	8135
1100-1115	FRENCH/FRANCAIS	5970	
1115-1215	ENGLISH/ANGLAIS	5970	
1215-1230	FRENCH/FRANCAIS	5970	

**CHINA** Peking's China Press Agency b/c's in Std CC at  
1100-1400 on 16105, 15574, 14820, 13845, 13760, 13700, 9180,  
5925, and on an SSB feeder on 4480,  
1500-1700 on 16105, 11522, 11204, 10487, 10173, 9135, 7425, 5925,  
and in SSB on 4480. (by permission, BBC MS)

**CLANDESTINE PATRIOTIC VOICE RADIO:** (anti-Burmese Gov't Gland.) Look for  
this one fm 0030-0115 and 1230-1315 in BB on 7240, 7235, 7230, 7198.  
This sta was once known as "Nat'l United Liberation Front Radio" and also  
as the "Patriotic Youth Front Radio".

**VOICE OF THE NATIONAL FRONT OF CAMBODIA:** This pro-commie Cambodian  
lang clandestine station is now sked'led fm  
0001-0200 1030-1230 all on 12005v, 10120v, 10080v, 9985v, 7015v, 6142v, and  
0400-0500 1330-1430 on 4675v. (by permission, BBC MS)

**VOICE OF NATIONAL UNITED FRONT OF KAMPUCHEA,** a Cambodian speaking sta,  
appeared in late Jan and disappeared in late Feb. Freq's were 7285,  
then 7325, then later on 7300 and it was sked'led fm 1257-1330. The ID  
and opening mx are the same for this sta and the pro-commie VNUFK. Maybe  
this is a black clandestine sta?? (via DX'er Isao Ugusa, Japan)

**PHNOM PENH NATIONAL UNITED FRONT OF CAMBODIA:** This is a new sta b/c'ing  
in Cambodian fm 0100-0130, 0700-0730, and 1300-1330 on 7287. Material fm  
this sta is anti-Phnom Penh Gov't. (by permission, BBC MS)

**VOICE OF THE PEOPLE FROM THE HEART OF THE ARABIAN PENINSULA:** This is  
an anti-Saudi clandestine sta which uses the 25 meter band outlet of  
11800 for its xnsms fm 0400-0500 and 1200-1230. (by permission, BBC MS)

**VOICE OF TRUTH:** This Greek-lang pro-commie sta and that its xmsms  
were to be discontinued. The VOT was 1st hrd on Mar. 20, 1958, using a  
Leipzig SW xmtr on 9730, and in April, two more xmtrs, believed to be  
located in Romania, became operational. The sta had been b/c'ing 13 times  
a day on two xmtrs believed to have been located in East Germany. The  
last VOT b/c was at 1120 on Jan 14, and, therefore, it must be assumed  
that the sta has closed down. (by permission, BBC MS)

**COLUMBIA** R Nueva Grande is installing two 15 KW xmtrs which should be  
in operation by 1976. (via Mide Peraaho, MN)

**CLANDESTINE OPSSI,** out of order. The Korean lang cland. sta, Radio -  
Echo of Hope, has extended their sked. They now b/c fm 0200-0500 and  
1230-1530 on 6348. (many thanks Isao...Isao Ugusa, Japan)

SUPPORT NASWA - CONTRIBUTE TO YOUR FAVORITE SECTION TODAY

**ECUADOR** Escuelas Radiofonicas Populares is located in the city of Riobamba in central Ecuador. Riobamba, capital of the province of Chimborazo, is a city of 30000 people nestled in the Andes close to Mt. Chimborazo (20577 ft). Some of the most beautiful scenery in Ecuador is to be found in this area. The region is chiefly agricultural although skilled craftsmen are also found in the area who produce folklore items and various other things. In addition to pgms of music, the sta b/c's courses of basic education directed primarily toward the peasant population. Escuelas Rdf Populares has been noted with a good signal on 3985 after 1000. (very good Joe...Joe Di Leo, CT) If some of you all would like to make similar contributions to LN, "write on", they will be quite welcome. Maybe this could be a regular thing if we has enuff support.

**ECUATORIAL GUINEA** R. Santa Isabel has been noted carrying EE news at 2030 on 6250. (by permission, BEC MS)

**ENGLAND**



K1,K2 Central America and Caribbean

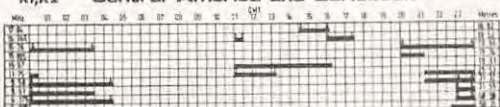

(thanks to Glenn Hauser, OK and David Snyder, NY)

L1,L2 Canada USA and Mexico

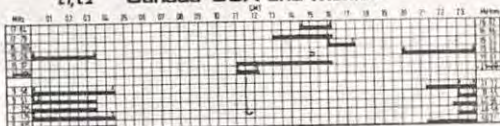

**FRANCE** Check out "Paris Calling Africa" which is b/c daily fm 1700-1800 on 15140 and 15120. Its a pgm worth listening to, sez Al Miller, OH.

**GERMANY, WEST/SIERRA LEONE** DW has been testing their new 250 KW xmtr which is located near Freetown, Sierra Leone. Ancmts in EE and GG are b/c fm 0627 on 5980. (by permission, BEC MS)

**HOLLAND** R. Nederland has announced some Spring changes, such as these:  
 2130-2250 11730 X-5965 // 9715 (all Lopik) (via Glenn Hauser, OK)  
 2000-2120 15120 X-11720 (Talata) by the way, be sure to listen to Glenn's NA rpt which is b/c in the RNDXJB.

**INDONESIA** Craig Tyson, Australia, rpts some corrections and additions to the Indonesians listed in the 1975 WRTH. For instance ....

- RRI Ujung Pandang 2490 s/on 2130, not 2100
- 3541 RPKD Bangkalan: X-3578 w/nx fm Surabaya
- 3055 Kalubatan Sampang, X-3047 (RKPDK)
- 3909 RPKD Tasik Malaya, not Pusat Melaya
- 3908 RPKD Surakarta: delate
- 4089 RPKD Blita - not Butar
- 4535 R. Sukahardjo: delete and add R Sura Magelang
- 3762 delete RKPDK Kupang; add RKPDK Tuban
- 3612 RPKD Bandor, delete ... add RPKD Banjar
- 3462 RPKD Timor - delete

(many thanks for the updates mate, Craig Tyson, Australia)

**JAPAN** Radio Japan b/c's their NA svc fm 2345-0045 on 15270 and 15300. At 0100-0300, tune 17825, 17725, 15235, 15235, and 15195 for the North and Latin American and Hawaiian Svc. (Glenn Hauser, OK; Henry DuRant, Thail'd)

**KOREA, NORTH** The local station at Wonsan is now on the new freq of 3030v. It is presumed that this channel is ex-2610. A local ID was caught before and after the local pgm at 1100-1110. (via DX'er Isao Ugusa, Japan)

**RADIO PYONGYANG** is sked'led w/English fm  
 0500-0600 on 15630, 12075, 3890  
 0600-0800 " " " " 9820  
 1000-1100 11535, 9340, 3560 ... to the Americas  
 1200-1400 15630, 9372, 7580, 3560 (by permission, BBOMS)  
 1800-2000 9977, 6338, 3560  
 2000-2200 9415, 6575, 3890  
 2300-2400 15630, 11535, 3560

**MALAYSIA** LOOK for the Voice of Malaysia in English fm 0625-0855 on 15280 (fm 0830), 11900, and on 6173. (by permission, BEC MS)

**PORTUGAL** Emiss. Nacional, Lisbon, b/c's to NA in EE fm 0230-0300 and fm 0430-0500, both on 11935 // 6025. (Henry DuRant, Thailand)

NEW ZEALAND The NZBS beams to the Pacific Islands fm  
 1700-1945 on 9755, 11780  
 2000-0545 15110  
 0600-0845 9540, 11780

To Australia fm  
 0900-1145 on 9520, 11780  
 2000-0545 17900

To Antarctica (Sun's)  
 0015-0045 on 15280

(via Larry Talbot, WI)

NIGERIA The NBC is currently starting on a development project under which new b/c'ing houses and xmt'ing stations are being erected in each of the 12 Nigerian states. The external svc (Voice of Nigeria) is being equipped w/3 new 500 KW xmtrs, one of whose transmissions will be beamed to the Americas. (via Chief Engineer, NBC, Calabar; by way of J. DiLeo, CT)  
 WNBS, Ibadan, was hrd on 6060, but smothered by the BBC fm 0430-0500.  
 (via Dan Robinson, PA)

PORTUGAL The Voice of Hope has EE on 9670 every Sunday at 0830-0900 and 0930-1000. Also fm 2100.  
 (via Jim Toney, GA)

SAO TOME E PRINCIPE Try tuning 5338 before 2300. Sao Tome used to be here, but it has not been noted for awhile. (Dan Robinson, PA)

SOUTH AFRICA

(via David Snyder, NY  
 & Hank DuRant, Thailand)



**radio**  
**rsa**  
**THE VOICE OF SOUTH AFRICA**

East Africa & Middle East	1600-1850	15155 KHz (19m)	
		11900 KHz (25m)	
		7270 KHz (41m)	
West Africa & Europe	2100-2150	15155 KHz (19m)	9525 KHz
		11900 KHz (25m)	7270 KHz
North America	2230-2320	15155 KHz (19m)	9095 KHz
		11900 KHz (25m)	9525 KHz

TIMOR Dili continues to be hrd on 3668, contra to the listing in Feb's LN. In fact, Dili is probably the most consistent stations hrd in Perth; consistent monitoring of Dili confirms that is has not changed to 3268. This noted by Craig Tyson, Australia.

UNITED STATES OF AMERICA Although the brand new 1975 WRTH says that Radio Sta KGET, La Voz de la Amistad, in Calif., accepts reception rpts from "target zones only", it is possible to get a QSL fm them if you live outside of the "TZ". The station quotes, "We preferrpts fm IA and the Far East and require two IRC's for a surface mail response and six IRC's for airmail. Within the US, rpts will also be acknowledged with a QSL card; include 22¢ in stamps for airmail and 16 cents in stamps for surface mail. No IRC's fm the USA please!" Their latest sked has EE slated on 5980 fm 0700-0800 and 1000-1100. (via Kerryn Brandt, NY)

USSR The March IFRB Tentative HFBC Schedule lists much USSR usage with Central Asia locations which check out precisely with the observed hours and beams for the Winter period. Some usage changes noted so far in March and more will probably be made in early April. Signal strength and fading characteristics indicate Central Asia locations. The listed QTH's therefore appear to be accurate. The following were hrd in VA during Feb., mainly fm 1100-1300, particularly on days of moderate ionospheric disturbances. They are dropping down now (March), but some still are holding up, particularly 9720.

6080	Frunze	1100-1730	9655	Tchita	1300-1600
7135	Dushanbe	0200-0430	9710	Frunze	1130-1500
7170	Novosibirsk	0930-1300			2200-0400
7205	Frunze	1230-1500	9720	Frunze	1130-1600
9580	Dushanbe	1230-1530	11820	Krasnoarsk	1130-1500

(an excellent job Roger ... Roger Legge, VA)

VIET NAM, NORTH Since early Feb., VoV's 6384 has been replaced by 6450, which is hrd until s/off at 1700. (That should clear the way now for Ulan Bator on 6383) The VoV also uses 4995 // 7510 // 9840, all in the home service, which signs off at 1630.

(thanks for your find contributions Isao ... Isao Ugusa, Japan)

English may be hrd at 0100, 1000, 1300, 1600, 1800 on 12035, 10040, and 15012 from Hanoi, according to a sked received fm Hanoi by Dave Snyder, NY

ZAIRE R. Kisangani has been hrd lately fm 2048-2059\* w/ fair to good signals on 6085. Give them a whirl, sez Dan Robinson, PA.

The following is something that might be of interest to some of our Pacific area DX'ers. Scott Reeves, MD, has sent an interesting clipping from the WALL STREET JOURNAL's February 10th edition which gives some good information on the Timor/Indonesian situation.

## Portuguese to Leave, And Colony Isn't Sure It Wants Them to Go

Island Sees Need for Help;  
Some Back Indonesia Tie;  
Does Region Face Chaos?

### 'Tourists at a Hippie Hilton

By WILLIAM D. HARTLEY  
Staff Reporter of THE WALL STREET JOURNAL  
DILL, Portuguese Timor — When Lisa began, the Manbal people say, the younger of two brothers on Timor led to make his life overseas. When the older brother could no longer control the warring tribes, he went in search of his brother, seeking a sign of authority. He returned with the Portuguese flag.

It was in the early 16th Century that the Portuguese first came ashore here to buy sandalwood from the natives and convert them to Christianity. Over the years, despite an occasional interruption such as occupation by the Japanese in World War II, the Portuguese influence has become pervasive. As the Manbal tale illustrates, Portugal has crept into a mystical role in religion and myth, a role that won't easily be cast off by new rulers.

But new rulers there will be, because Lisbon is getting out of the business of running other lands. "Timor," a visiting Portuguese official has said, "will be what the majority of the people want it to be."

The prospect is disquieting to this most remote, most ignored, least developed colony of Portugal, asleep for generations, knowing little of the outside world and caring less.

#### Little Thought of Freedom

The Timorese are still struggling with the idea of change. They had given freedom much thought before last April 25, the day an army camp in Lisbon overthrew the dictatorship of Marcel Caetano, the last of the European colonists. The government press and radio here had never told of independence movements elsewhere, and a deliberate policy of nondevelopment and isolation kept political aspirations nil.

What there is of an active political elite is concentrated in Dill, the capital, and there are so few politicians that leaders of competing parties are sometimes related. Some of these men want to stay with Portugal, at least until they are sure Timor is ready to go it alone. Others want early independence. A third group would join Indonesia. About the only agreement right now is that the people are too immature, the economy too weak, to stand without some kind of aid.

The political parties, all formed after April because any political activity before then ended with a jail term or deportation flood the government radio with their messages and four villages seeking converts. Locals flock to the banner of the party making a plea one day, only to change allegiance when the next arrives.

#### A House Without a Roof

"Timor has been a house for 450 years with everyone locked inside," says Antonio

Muniz de Silva, a native Timorese who followed the custom of adopting a Portuguese name on baptism. Mr. Muniz de Silva is a "turra," which is a sort of hereditary supreme chief of a large area. "Now," he adds, "they've pulled the roof off the house and everybody is going in different directions."



The people have always done what the Portuguese told them to do, and making a decision is strange to them. Before that momentous day in April, there was a servile council to advise the governor but "the governor would say 'This is what I want' and they'd say 'It is okay,'" says Mario Lemos Pires, the newly appointed governor, who is trying to create a new council. "Now I ask for advice and they say 'You decide,'" he says. "The people aren't prepared to make decisions."

Soon they must: Lisbon and Gov. Pires are talking of an October election of an assembly to draw a constitution.

#### Impact on Indonesia Seen

If the only thing at stake were the future of the 650,000 persons in this colony about the size of Connecticut, the rest of the world could ignore the place. But there are those who believe that what happens here could affect the stability of the largest nation in Southeast Asia, Indonesia, and in general cause chaos.

Timor, an island of 13,071 square miles, sits near the end of the chain of islands arching eastward from Java. Portugal occupies the eastern half of Timor. Indonesia occupies the western half except for the tiny Portuguese enclave of Oekusi on the northern coast. Indonesia considers the whole area within its sphere, though as long as Portugal was here, the Indonesians didn't worry.

But an independent Portuguese Timor, the Indonesian leaders are believed to think, would provide a bad example for their country. Indonesia is, after all, less a nation than a conglomeration of 125 million people of different cultures, races and languages, often with little in common.

"There is independence talk in the Celebes and the Moluccas (parts of Indonesia)," says one diplomat familiar with the area. "These people could say that if Timor is independent, then why not them?" Some say the Indonesian half of Timor might be first to go.

A fracturing Indonesia could add to uncertainty in an area that already sees a east-then-stable Papua-New Guinea about to separate from Australia and a growing secessionist movement in Muslim Mindanao in the Philippines. Huge oil and mineral investments in Indonesia would be threatened.

Indonesians publicly decry talk of separation as nonsense, but some do express their worry that an independent Portuguese Timor would be a vacuum-unstable, ungovernable and broke. Not the least of their worries is that Lisbon's new leftist leaders have made overtures to Peking.

Currently Portugal recognizes Taipei and there is a Nationalist Chinese consulate in Dill watching over the 14,000 Chinese here, nearly all of whom carry Taiwan passports. A change could put a Communist Chinese consulate in its place. Indonesia, which doesn't recognize either China and sees, according to one analyst, "Reds in under every bed" since an attempted Communist coup in the mid-1960s, isn't happy with the prospect.

The Indonesians may have thought their fears were justified when Maoist slogans were painted on a monument of Prince Henry the Navigator in a Dill park a while back. Then it was discovered that the paint-

ing was the work of Portuguese soldiers who wanted to go home and who figured that signs of unrest might prompt the government to pull out precipitately.

Most outsiders dismiss Indonesia's fears. They say that China is trying to improve its relations with Southeast Asia, not subvert the region. Nor is there much, if any, Communist influence among local Chinese, it is believed.

In any case, Indonesia clearly would like Portuguese Timor to join up. Radio Kujang across the border in Indonesian Timor constantly broadcasts propaganda to this half, calling on Timorese to "join your brothers," a political party here called Apodeti, which Pires unit, admits, according to its secretary that it is financed by "private people" in Indonesia. The party doesn't seem to have widespread support.

One political leader in Dill, assessing the possibility of an Indonesian invasion after the end of Portuguese rule, says, "When the Portuguese leave, we will ask the Americans to come in and guard our borders."

That sort of naivete in the wake of Vietnam isn't unusual here, for the Timorese know little of the outside world or of what has happened in the past few decades. Mainly, they know Portugal. In some parts of the colony, the Portuguese flag is sacred; to stand in its shadow is sacrilege.

In little ways the natives in the mountains adopt Portuguese customs. Visitors must be given thick, sweet coffee in dentulase cups. Catholics get mixed with the native animism and in one village a statue of the Virgin Mary has become something of a weather deity used to appease the gods who would let the river rise and flood in the wet season.

The Portuguese discovered Timor between 1510 and 1515, and today it is one of the last remnants of their once wide influence in Asia. Portuguese carrying coals and cashbox opened much of Asia to the West; they were the first Europeans to visit Japan. Along the way they founded their colony of Macao on the coast of China and settled along the Malacca Strait in what is now Malaysia. Some small fishing villages there still speak a corrupted form of Portuguese.

In Timor the Portuguese mostly let the natives follow the old ways as long as it didn't interfere with the colonial government. Blood feuds and vendettas remain common, anthropologists say, because the Portuguese never really cared if one native killed another. Up to a few decades ago, they say, open tribal warfare was tolerated. By design (locals weren't allowed to travel without a pass, and passes were seldom given) and by nature (the island's soaring mountains make movement difficult), the colony developed as a collection of isolated tribes and villages—what one man calls "an anthropologist's delight"—speaking some 35 separate languages.

In the towns, secret police, which have gone under many names but most recently were called the "General Direction of Security," or DGS, kept order with an iron hand. The police haven't any power now, but most Timorese still shy away from discussing them. "Sometimes we'd be talking at home with friends about government," says one young man who will identify himself only with his pre-baptismal name, Kaitula, "and the next day the police would come."

"Half the population was on the payroll of DGS," he says. "You never knew if you could trust your friends or relatives." This same man once landed in jail for eight days when seen talking to tourists. The DGS didn't want Timorese contaminated with foreign ideas, so they kept him in a cell until the tourists left. Many men were sent from Timor to the African colonies if they became ostreperous. Ironically, some whites were deported from Portugal to Timor for the same reason.

## Timorous Timor: The Portuguese Will Leave, and Colony Is Uneasy

Portugal ignored development until recent years. "It's only been in the last six years that Lisbon... money." It has been in the past four years that primary schools were built outside Dili. There still is only one high school, and although there are about 75 university students from Timor in Portugal, half of those are in their first year. There are only one or two university graduates among Timorese on the island. The illiteracy rate is put at 95%.

Portugal hasn't taken much from the island, though. Lisbon supplies more than half the current \$8.5 million budget and all the \$24 million for a five-year plan to improve roads and communications. Timor consistently runs a trade deficit, which Lisbon also makes up. "As a business, Timor is nothing," says Luis Ricardo, a government official. "It is hopeless." The main export is a rich coffee, but the quantity is small.

Development plans hinge on small industry and tourism. Timor now gets about 6,000 tourists annually but officials admit that these aren't the kind Timor wants. Mostly they are the barefoot backpack crowd from Australia who see Timor as the first stop on the road to Southeast Asia—and spend little.

Many stay at what locally is called the "hippie Hilton," a bare beach-house where for only \$120 a traveler can flop his sleeping bag on the concrete floor for as long as his visa lasts. Drawing more affluent travelers, even those attracted by the island's raw beauty, will be difficult until there are decent hotels and roads.

The Portuguese are trying to build up agriculture as well, believing that the island could be self-sufficient in food. But natives practice "slash and burn" cultivation: They burn down trees and underbrush, use the area for a year or two, then move on, and it is hard to change the practice.

Gov. Fries would like to develop a meat industry for export—there are tens of thousands of head of buffalo and the Balinese cow here—but since these are considered wealth and are particularly valuable when young men have to pay the "bride price" to the family of their girl, natives are reluctant to slaughter until long past the time the meat is any good.

Outsiders are becoming interested in Timor, though, and so local hopes are high. Broken Hill Proprietary Ltd., the largest company in Australia, is exploring for a variety of minerals, including manganese, chromium and gold.

Most encouraging are plans to drill for oil in Timor's offshore waters starting next May. Geologists know there is oil around because for decades natives have scraped seepage off coasts and used it for lighting.

Thanks to all of those who contributed to LN this month. All contributions to LN are most welcome. If you desire the return of your sked, please enclose a SASE with your report. Please, all times in GMT.

73 and Happy Listening,

*Dan*

### HELPING HAND

**FOR SALE - or trade** Hallicrafters S-38E general coverage receiver, excellent electrical condition...\$30.

Also, AMECO AC-1, 15 watt QRP transmitter, excellent condition, coils for 40/80 meters, crystals for 3825, 3980, 7120, 7250 KHZ...\$20.

Also, Heath RF Generator, 190-220 MHz...\$35.

...You pay postage...

Write Tony Fields, 124 South Shore Drive, Portage, Mich, 49002.

### NEBRASKA DYERS TO MEET

April 20, Sunday, from 2:30-5:30 pm CDT at Commercial Federal Savings & Loan, 12255 West Center Road, Omaha, Nebraska...From all appearances it should be one of the largest state-wide get-togethers ever held. For further details contact Mary Robbins, 6922 Spring St., # 207, Omaha, Nebraska 68106...Main thing is to be there!

BC221-C FREQUENCY METER w/crystal and original calibration book & w/regulated ac power supply. Also copy of appropriate sections of original technical manual. \$40 plus shipping or make offer...Write Tom Overcamp, 5107 57th Ave. #302, Bladensburg, MD 20710/...

Planning to revamp entire listening set-up, including new equipment. The following for sale...

Hammarlund HQ145A receiver, general coverage, \$120.

Allied AX-190 with modified bandswitch so that it now has 3 bands on upper range, rest on lower...\$170.

Heathkit SB310 receiver plus Heathkit SB620 Scanalyzer (gives 'scope display of received signal and spectrum on either side of received signal). Receiver has crystals for 90/60/49/41/31/25/20/19/16 meters. Receiver has 5 KHZ AM filter. Both for \$270...Have CW and Deluxe SSB filters for the receiver, both for \$50.

AMECO PCL-P RF Preamp...\$25

GILFER A-20 Preselector...\$30

Audio filters...MFJ CNF-2BX \$18 (750 Hz center fcy)  
MFJ CNF-2BX \$18 (400 Hz center fcy)  
MFJ LFF-1 \$10 10 pass audio filter  
(all filters used abt 2 hrs)

DATA ENGINEERING FMS-3 Frequency Marker Standard -\$20

(For all above, write Dan Ferguson, Box 8452, South Charleston, WV 25303...or call (304)-744-9609.)



# LOG REPORT

## SECTION - A

EDITOR: Bob Hill, WIARR/6  
1626 Bonita Avenue  
Berkeley, CA 94709

ASSISTANT  
EDITOR: Kevin Szot

DEADLINE: 15th of month

Despite deteriorating condx, a pretty fair crop of DX was reported this month. The stuff is there, all right -- just takes a bit of spadework. So let's start shoveling . . .

- 2200 CHINA. Foochow, Fukien. 1410 CC by W; weak (Young).  
2301 N. KOREA. Hyesan. 1235 KK by M, 1239 W took over and sounded like a PLA DJ gone wild; usually G lately; //2850. Never hrd as low as 2297 listed in WRTH (Szot). KK by M; //2670 (Young). (Time? BH).
- 2310 CHINA. R. Peking Home Svc here 1300, unlisted; was not //HS1, HS2 or PLA (Willis 2/18). Oriental lang & mx to 1300, then TC; seemed nx to 1306 with M&W. Definitely not JJ (even tho 770 X 3 = 2310!). VV? (Young). 1408 Red CC mx, CC talk by M&W; quite sure Communist, but not //other 120M CC's, HSl or HS2; F (Szot 3/9).
- 2312 JAVA. RRI, Jakarta. 1430 local IS(?), W in nx; //2450/2377 (Young).  
2325 (T)INDONESIA. UnID; suspect Indo with choral mx; no //s found (Young). (Time? BH).  
2333 (T)JAVA. RRI, Jember. 1318-1504 mx, talks; //other RRI till 1325 and again 1500 with TC, IS, into RRI nx. Extremely strong 1423 (Young 2/26).
- 2340 CHINA. Foochow, Fukien. CC mx and W voice; strong by 1415 (Young).  
2340 NEW BRITAIN I. RWNB. 1109 nx by M; F (J. Davis). (Lang? BH). 1256 Pidgin, 1300\*; Foochow het. Other PNG stns stay on till 1300 at times (Young).
- 2350 CHINA. Tsinan, Shantung. 1312 CC conversation (Young).  
2350 JAVA. RRI, Yogyakarta. 0950 native birdcall IS, 1000 local ID and into evening syc in Indo; //5047. Logged in Denpasar, Bali; local time 4:50 PM (Padula 2/18).
- 2360 GUATEMALA. R. Maya. 1130-1145 SS, many IDs, seemed relig mx; F (Price). 1235 SS mx; weak; gone by 1306(Young).
- 2370 JAVA. RRI, Surabaya. Well hrd with daily EE svc for visitors 0930-1000. Opens w/ nx by W (mostly local items), 0945 "You are tuned to Radio Republik Indonesia Surabaya, the English Service"; TC, then and that EE would be hrd tomorrow same time; continued with modern EE/Western pops till 1000 close. Not listed WRTH/75 or anywhere else I've seen. Hrd from Denpasar (Padula 2/18). 1436 Indo talk; wk (Young).
- 2376 NEW GUINEA. R. Chimbu. 1131 M; F (J. Davis). (Lang? BH). 1237-1300\* Pidgin, mx (").  
2377 JAVA. RRI, Jakarta. 1428 Indo mx; strong; //2450 (Young).  
2390 GUATEMALA. Voz de Atitlán. 1115-1130 SS talks, few IDs, sev ancts in Indian lang; F-G (Price). 1236 SS mx, guitar; 1303 gone (Young).  
2390 (T)JAVA. RRI, Cirebon. 1417-1437 Indo mx & voices; strong; no //s found (Young). (Jim, Cirebon is about 50 mi. ENE of Bandung; old spelling is Tjirebon. BH).
- 2410 BRAZIL. R. Em. Educ. Rural. 0930-0945 vocals, PP talks, ID; F (Barto 2/23).  
2410 NEW GUINEA. R. Goroka. 1153 bagpipe mx; F (J. Davis). As early as 1245 with EE C&W mx, M in vernac or Pidgin; 1302\*. Seems harder catch than other PNG stns (Young).  
2415 CHINA. Wenchow, Chekiang. \*1230 NA, into CC; vy strong (Young).  
2428 NEW IRELAND I. RNI. 1215 chants (J. Davis). 1246-1258 S. Seas mx, M in vernac; off 1302 RC. Strong het from PLA/2430 (Young).
- 2430 BALI & LESSER SUNDA IS. RRI, Denpasar. Noted after 0900 (4 PM local). 0920 gamelan mx, 0931 local ID with TC and wavelengths, ancg as "Siaran dalam Bali, Indonesia"; into warta berita (local nx read by W); //3945. Also 0700 with relay of Jakarta nx, 0710 local ID; again //3945 (Padula 2/16).
- 2430 CHINA. PLA. 1236-1419 CC by M; G (Young, J. Davis).  
2440H COLOMBIA. R. Cordobesa. \*1123 ID, NA, ID again, ads, mx; F (Jones 3/10).  
2440 VENEZUELA. R. Girardot. 1032-1100 vocals, IDs, TC, mucho speeches; G (Barto 2/24).  
2441-2 UNID. 1110 native Islands-type mx, 1110:30 mx off, 1111 back on briefly with Hawaiian mx, then CC; F (Whitacre 2/28).
- 2450 JAVA. RRI, Jakarta. 1135 anct "This news broadcast is coming to you from the Metropolitan English Service of Radio Republik Indonesia Jakarta" (Padula 2/18). 1445 Indo mx, M&W in Indo; not //4805. 1500 RRI IS, then // all RRI stns (Young).  
2450 PAPUA. R. Western Highlands. 1252 M in vernac, light mx, seemed like Bible quote past 1300; ancts to 1301, then off (Young).
- 2460 CHINA. Another unlisted R. Peking outlet, again not HSl or HS2. 1245 atop Indo, better than other new CC on 2310 (Willis 2/18). 1259 positive CC by M, 1300 no ID or anct; 1327 seemed lang lesson (Young). Noted around 1400-1415 (Szot, Hill).  
2468 PAPUA. R. Northern District. 1227 vernac ancts, mx; 1230\* (Young).  
2475 CHINA. Hangchow, Chekiang. 1259 CC mx; strong (Young). 1305 CC play; VG (Willis).

- 2490 JAVA. RRI, Semarang. 2330 chimes, ID, "Warta berita, Radio Republik Indonesia Semarang, pagi ini," then local political and financial nx. Hrd in Semarang (Padula).
- 2490 SULAWESI. RRI, Ujung Pandang. 1317 W Indo voices //4719 (Young).
- 2510 S. KOREA. KBC, Taegu. 1140 KK drama (Sparks). 1307 KK by M; strong (Young).
- 2600 CHINA. PLA. 1323 CC mx, singing (Young).
- 2670 N. KOREA. Sariwon. 1300 KK ancts. Also 2300 under Indo stn (Willis). 1307 KK //2301/2775/2850/4273 and prob others, altho not hrd; F. A regular in CA (Sztoc). 1326 KK mx, ancts //2301 (Young).
- 2750 N. KOREA. Chongjin. 1148 Pyongyang relay, military chorus (Sparks). 1331 KK by M //2670 etc. (Young). J. Davis, Willis, Young).
- 2775 N. KOREA. Hamhung. 1150-1335 KK, military mx; 1300 nx; //2750 etc. (Sparks, Sztoc, 2800 CHINA. PLA. 1243 W in CC; G (J. Davis). 1336 W in CC vocal (Young).
- 2850 N. KOREA. Pyongyang. 1348 KK by W; strong (Young).
- 2960 CHINA. Changchun, Kirin. 1340 CC mx, singing; weak (Young).
- 3016 N. KOREA. Pyongyang. 1300-1500\* JJ //6455/6538/6623.5 (Willis, Young).
- 3031 N. KOREA. Pyongyang. 1347 W in KK //2850 (Young). (Young 3/3).
- 3092 UNID. 1211 light mx; earlier thought to be Central America as was gone by 1247
- 3140 UNID. 1452 seemed KK, 1500 poss bell IS; perhaps 2 X 1570 of FEBC, S. Korea, 250 KW (Young). (Right, Jim -- both your Editor and Asst. Ed. have ID'd as such. BH).
- 3165 JAVA. RKPDP Kotamadya Surabaya. 1250 local ads for things like "Untuk Anda" and Surabaya products; strong in Denpasar (Padula 2/18).
- 3205 INDIA. AIR, Lucknow. 1420-1430 Indian mx, M ancts; weak (Young). dula).
- 3205 JAVA. RRI, Bandung. 1240 local ID, then gamelan mx; 1300 into Jakarta relay (Pa-
- 3210 MOZAMBIQUE. RCM, L.M. "A" Pgm in PP 0440-0445 with local mx; P (Mayer 2/19).
- 3215 VENEZUELA. Ondas Panamericanas. 1035 SS talks & mx; G (McCoy).
- 3220 NEW GUINEA. R. Morobe. 1245-1300 Pidgin, G6W mx; nice relay, some ute (Tuchsch'r).
- 3223 BALI & LST. RRI, Mataram. Hrd all day in Bali -- strongest 90M except for Banjarmasin/3250. Sked in WRTH/75 needs updating, as noted 0200-0400 too (Padula 2/18).
- 3223 INDIA. AIR, Simla. At last! 1715-1730+ chant-type pgm (relay of Delhi) after Mataram s/Off (Willis 2/17).
- 3225 VENEZUELA. R. Occidente. 0024-0100 pretty LA mx; CW & ute QRM (Miller, Tuchsch'r). \*1025 full IDs (calls, freq), then nx; G (Jones, McCoy).
- 3235 INDIA. AIR, Gauhati. \*1300, into Hindu mx (Young).
- 3240 IRAQ. Baghdad. 0414-0424 M talk -- sounded Asian, listed Kurdish (Reeves 3/2).
- 3240 PERU. R. America. 0345-0355 ID, SS talk on Peru; P (Mayer).
- 3245 PAPUA. R. Kerema. 1247 chimes; F (J. Davis).
- 3245 VENEZUELA. R. Libertador. 0344 SS nx, TC, 0357\* NA; G (McCoy). 0433-0505+ with a dozen IDs, long dull speeches (perhaps pre-Lent carnival pgm); //most YVs (Reeves).
- 3250 KALIMANTAN. RRI, Banjarmasin. 1058 local ID; dominant this time from Bali (P'la).
- 3250 S. AFRICA. SABC. 0135-0147 EE, US pops, clas mx, ID; F but hvy RTTY (Shingler). 0250-0310 pops, ads, Western-flavor orch mx, "mx to relax by"; not as much interruption by ads as other SABC svcs (Earhart). 2200-2330+ pops, ads, EE (Whitacre).
- 3255 LIBERIA. ELBC. 2300-2330 EE, hi-life mx on 2/28; not hrd too often now (Whitacre).
- 3255 VENEZUELA. Voz de El Tigre. 0305-0315 SS talks, many IDs; F (Powers). 1028 SS, LA guitar mx; F (McCoy).
- 3259 JAPAN. NHK, Sendai. HS relay. 1125 M in JJ (Sparks).
- 3260 CHINA. Kweiyang, Kweichow. 1406 CC mx, W singing (Young).
- 3265 MOZAMBIQUE. RCM, L.M. 0404 pops, EE DJ; F (McCoy).
- 3277 JAVA. RRI, Jakarta. 3rd Pgm. 1115-1120 Indo pops. Hrd in Denpasar (Padula 2/18).
- 3280 ECUADOR. Voz del Napo. 0330 SS relig talks, 0338\*; F (McCoy).
- 3286 JAVA. RRI, Madun. 1120 local ID by M. Hrd in Denpasar, 500 KM away (Padula 2/18).
- 3288 MALAGASY REP. RTM. Now has Malgache lang this freq instead of former FF. Noted 1750 at E level (Willis 2/9).
- 3290 GUYANA. GBS. 1106 EE, pops; strong (Jones).
- 3300 BELIZE. RB. 0427-0512\* EE, soul & rock mx, 0500 nx; off with NA & GSTQ; P-E (McCoy, Lineback, Moritz, Nebron).
- 3300 CHINA. PLA. 1249 W in CC; G (J. Davis). 1409 CC by W //3200 (Young).
- 3305 INDIA. AIR, Ranchi. 1415 Indian mx; buried by OC (Young). (That's what happens when you put a Ranchi signal on the air. BH).
- 3307 RHODESIA. RBC. 0400 EE ID, pops; F-G (Whitacre 2/27).
- 3310 CHINA. Changchun, Kirin. 1307 CC singing; buried by RTTY (Young).
- 3315 INDIA. AIR, Bhopal. 1257-1304 Hindu mx, ancts (Young).
- 3316 SIERRA LEONE. SLEBC. 0610-0625 EE ads for cigarettes ("get the best, get ???"), also vernac talk; drum mx, some pops. QRM de hi-speed RTTY on 3315 (Earhart). 0700 BBC nx (Tobin). 2309-2336\* EE, rock, lots of IDs (Tobin, Barto, Whitacre, Miller). (Sev reporters wondered if SLEBC using new hi-pwr xmtr now. BH).
- 3320 UNID. 1251 excited W in Oriental (J. Davis). (What else but Pyongyang? BH).
- 3322.5 BOUGAINVILLE I. RB. 1130-1300\* daily, native & pop mx, EE ancts; G (Whitacre).
- 3325 GUATEMALA. R. Maya. 1150-1202 soft relig mx, lang, 2 mentions of Maya (Russell).
- 3325 VENEZUELA. R. Monagas. 0100 (Whitacre) 0955 (Perdue) 1032 (Jones) ads, LA mx.
- 3325 W. IRAN. RRI, Jayapura. 1200-1400\* over another Indo -- Jember? (Willis 2/16).
- 3335 NEW GUINEA. R. E. Sepik Dist. 1140 Pidgin, native chorus with local songs (Miller). 1235-1305\* Is. and C64 mx, 1258 gave many freqs incl 19MB (lang poss EE), off with GSTQ (Russell).
- 3336 SENEGAL. RdS, Ziguinchor. 0624-0706 native mx, vernac; F-P (Earhart, Hauser).

- 3345 HAITI. 4VSO. 0042 FF or Creole(?), kids singing relig songs; F (Miller).
- 3346 ZAMBIA. ZBS. 0423 lang w/ mx & such; not a bad sig considering distance from WCNA -- 120 KW helps, though (Sztot). (I've noted this phenomenon for years, Kevin: the South-Africa-to-WCNA path is invariably better than South-Africa-to-ECNA at the same time. W6's and W7's commonly beat out W1's and W2's into ZS and -- since we're talking about Zambia -- 9J2. But as for why ... who knows? BH).
- 3360 GUATEMALA. Voz de Nahualá. 1135-1218 FO, songs, strong mx, SS; bad RTTY (Earhart, Kusalik). 1305\* after ID; late; hrd after PNG s/off (Willis).
- 3365 VENEZUELA. R. Pto. La Cruz. 0030-0100 IDs, LA mx, some US rock, ads; G-VG (Perdue, Price, McNeil). 0158\* on Sun. (list 0400\*) (Perdue). 0210-0345 SS, LA mx, frequent IDs (Tuchscherer). 1043 LA mx, ID, ads (one for General Electric) (Jones).
- 3366 GHANA. GBC. 2253-2305\* EE, relig pgm, NA; VP-F (McCarthy, Miller).
- 3375 ANGOLA. Em. Oficial. 0001\* PP ancts, into "A Portuguesa" (Miller 2/25).
- 3375 BRAZIL. R. Olinda Pernambuco. 0245-0310 PP, LA mx; 0300 ID & bulletins, then back to mx (Tuchscherer). 0418-0501 soccer, then lively Braz mx, singing ads, many IDs as "Radio Olinda" (never added Pernambuco); some CW QRM at times (Patterson, Miller).
- 3380 ECUADOR. R. Iris. 1120 block ancts in SS (Willis). 1122 ID by M&W, mx, ads (Mer-)
- 3380 MALAWI. NBC. 0342-0405+ EE & Chichewa IDs, EE relig talk & choir, Af barbershop quartet; IDs came at 0345 and 0405 (Whitacre, McCoy).
- 3385 FR. GUIANA. ORTF. \*0916 FF ancts after "La Marseillaise"; LA QRM (Perdue). \*1000 same stuff (Jones).
- 3385 NEW BRITAIN I. R. Rabaul. 1254 mx; G (J. Davis).
- 3390 ECUADOR. R. Zaracay. 0431 dominating 90M w/ LA pops, M DJ; slight QRM (Sztot 3/8). 1025-1124 Andean mx, ancts, ads ("Fantastica") (Earhart, Whitacre, Miller).
- 3395 VENEZUELA. R. Universidad. 0015-0030 "Música Popular," ads, IDs (Tuchscherer). \*1020 NA, W giving ID; G (Jones).
- 3396 NIGERIA. NBC, Kaduna. \*0430 EE ID, Hausa chants; F (Mayer 2/14).
- 3396 RHODESIA. RBC. \*0355 church bells, 0400 ID in EE, then nx, pops, ads (Kusalik).
- 3400 CHINA. PLA. 1145-1204 CC; P-F. 1st time hrd (Whitacre). 1225-1232 CC mx, W talk, then M (Perdue).
- 3425 NEPAL. RN. \*1146V IS, talk in Nepali (presumed); F (Whitacre). 1220-1245 FO, weird Oriental mx, M singing in Nepali; another day 1206-1240 FO, IDs on  $\frac{1}{2}$  &  $\frac{1}{4}$  hr (Kusalik).
- 3520 UNLD. Seemed CC by W (Young). (Time? BH).
- 3550 UNID. 1226 Indo singing, mx; weak (Young 3/1).
- 3558 N. KOREA. Pyongyang. 1110 RR; drifting from nominal 3560 (Willis 2/26).
- 3607 JAPAN. NHK, Kawaguchi. HS relay. M in JJ, 1200 pips (Sparks). 1223 JJ (Young).
- 3640 UNID. 1153-1200+ SEA-type violin/string mx, M&W Asian lang; 1200 six pips; hi QRM (Perdue). (This is of course PLA, which has been on this freq for sev months. BH).
- 3668 PT. TIMOR. ERTP. Around 1000, PP political talks; G (Padula). 1327-1434 PP ancts; mx, etc.; het with 3670 (Young).
- 3775 (T) BALI & LSI. RPKPK, Sumbawa. 1427 Indo ancts, mx to 1440; wk but clear (Young).
- 3797 UNID. Seems Indo. Indo ancts, mx from 1232 past 1311; no RRI relay or IS at 1300
- 3800 JAVA. RPKPK, Jember. Seemed \*1230, Indo talk & mx past 1240 (Young). (Young 3/3).
- 3892 N. KOREA. Pyongyang. \*1400-1530\* FF //9820 (Young).
- 3910 JAPAN. FEN. 1214 W DJ in EE, rock mx; 1st time hams let up enough! (Whitacre 3/1).
- 3935 JAVA. RRI, Semarang. Sunday 0100-0200 & 0600-0700 (extended svc) (Padula).
- 3940 CHINA. Wuhan, Hupei. 1246 M in CC (Young).
- 3945 BALI & LSI. RRI, Denpasar. S/on is 0957 (not 0900 as per WRTH); gongs and gamelan mx till 1000, when local ID and greeting "selamat malam" by W. Joins 2430-kHz out-let then. Also hrd 0600-0700, when is weaker than Surabaya in Surabaya (Padula).
- 3945 (T) NEW HEBRIDES. R. Vila. 0850 M in FF, 0900 tent ID, then native mx; P (Whitacre).
- 3950 CHINA. Sining, Tsinghai. 1247 W in CC (Young).
- 3965 PAKISTAN. RP, Islamabad. Often \*0055, chants, 0200 ID, nx //3915; 0244 EE nx; F. Per Hairon via DSMCI, this is my "Iraq" of 2/75 LR-A (Reeves).
- 3970 W. GERMANY. DW. 0000 IS, then seemed GG, clas mx; clobbered by QRM (Moritz). 0040 GG by M&W, also mx (Tobin).
- 3970 CHINA. Huhehot, Inner Mongolia. 1250 W in CC //3950 (Young).
- 3975 ENGLAND. BBC. 0220 clas mx, Farsi lang; 0229 WS ID, nx; 0235 interview. Not // other WS channels; not accounted for in published skeds. 0300 tones every 2 sec, then s/off; P-F (Hauser 3/6).
- 3975 JAVA. RRI, Surabaya. S/on 0958 (not 0900 as per WRTH) with theme mx, chimes, ID for RRI "Programa Satu" (1st Pgm); hrd 2/18 from Denpasar. Also hrd from Surabaya itself, 0001 relay of Jakarta nx //1260 MW (Padula).
- 3980 S. AFRICA. SABC. 0230-0400 EE nx, ads for cigarettes & soft drinks; pop mx; also Afkns talk. Poss VOA Munich under around 0245 (Miller, Earhart, Moritz).
- 3985 ECUADOR. Escuela R'fonica Pop. 0240 SS & relaxing LA mx (Miller). 1050-1118; before 1100, seemed in lang, mentioned Af countries like Uganda & Zambia. After 1100, SS, Ec mx (Earhart).
- 3985 SWITZERLAND. SBC. 0700 EE; strong (Tobin). hart.
- 3990 LIBERIA. VOA, Monrovia. 0535-0550 EE, Judy Garland records, etc. Only 8 KW (Ear-
- 3991 N. VIET NAM. Viet Bac. Finally ID'd. VV till 1400\* //6793V. Pleased re this! (Wil-
- 3995 S. AFRICA. SABC. 0256 R. RSA IS, \*0300 EE to EAF; much ham QRM (Price). 1s).
- 3995 W. GERMANY. DW. 0030-0100 GG, typical band mx, 0100 poss nx (Earhart). Another "first" for DW, apparently, as this freq now listed for NA Svc per anct on 6145 at 0201 on 3/3. Ckd, found P //6145. Anyone recall any other stn using 75M for NA Svc?

- (Hauser). (And so DW opens a new dimension in its policy of "the public be damned" -- first ruining large segments of the SWBC bands with its innumerable megawatt relays, now operating a NA svc on 75M in total disregard of the ITU rule against QRM'ing another region's amateur band. Grrrrrrr! (BH). 2332 CG, IS, ID (Miller).
- 4010 KIRGHIZ SSR. Frunze. 1242 RR mx, occasional ancts (Willis 2/17).
- 4068 CHINA. Huhehot, Inner Mongolia. 1320 M; G (J. Davis). (Lang? Details? BH).
- 4081 INDONESIA. New stn here hetting with Ulan Bator, but irreg operation. 1200 Jakarta relay (Willis 2/10).
- 4110 CHINA. Urumchi, Sinkiang. Uighur svc //7050, whilst 6280 has CC. 1130 (Willis). 1257 M in CC (Young).
- 4114 CLANDESTINE. V. of the Rev. Party for Reunification (Korea). 1325 M6W; G (J. Dvs).
- 4180 CHINA. R. Peking. \*1100-1130\* in Lao(?) //7050 (Willis).
- 4273 N. KOREA. Kanggye. 1238 W in KK seemingly //4114 but 20 sec out of sync (Sztot). 1328 KK by excited W (J. Davis). (Of course she was excited, Jim -- she knew you were listening! BH). 1356 KK mx, ancts by M (Young).
- 4328 CHINA. PLA. 1331 CC; G (J. Davis).
- 4375.5 INDONESIA. UNID RPKM hrd here daily since 2/20 from as early as 0930. Variety of Indo mx (pop & local), 1200 RRI nx relay, then mx till 1430, when usually Moslem chants. 1500 either s/off or RRI relay, in which case 1520\*. Modulation makes ID super-difficult; also ute and PLA QRM. No listing on or near freq (Hill).
- 4470 BOLIVIA. R. Movima. SS, ID 0500; P (Mayer 2/20).
- 4535 JAVA. R. Sukoharjo. 1040-1304 sev nights w/ Indo mx, ancts. Not //RRI stns. 1200 TC, 1300 non-RRI nx (Young).
- 4600 (T)JAVA. R. Trenggalek or RRI, Serui. 1300 //RRI with nx. Trenggalek reported inactive, Serui supposed to be on 4605, so ...7 (Young).
- 4679 ECUADOR. R. Nac. Espejo. 0115-0130 SS, EL mx, W talk, sev IDs (Moritz). 0335-0340 SS by M, LA mx (Powers). 0547 quiet SS mx, 0549 ID & gave freqs (Sztot). 1125 SS; loud (Willis 2/25).
- 4698 JAVA. RKIP, Surabaya. 1315-1321 little bits of mx with M butting in; ID hrd as "R. Khusus ..."; F (Sztot). 1445 W in Indo (Nebron).
- 4717 BOLIVIA. R. Riberalta. 0350-0400 SS, LA tunes, 0400 ID; P (Mayer 3/4).
- 4719 SULAWESI. RRI, Ujung Pandang. 1255-1303 Indo by M6W, 1259 "Love Ambon," pips, seeming ID, more talk (Russell). 1520 Indo talk, vocal mx (Nebron).
- 4725 ECUADOR. R. Via. 2316 SS, LA mx; wk (Whitacre 2/23). (You get ID on this? BH).
- 4745 UNID. LA stn 2311 with nx, fanfare between items; 2313 native LA-type singing; P with RTTY QRM (Whitacre 2/23).
- 4750 PAKISTAN. RP. 1340 in Urdu //5950 (Willis 2/17).
- 4750 ZAIRE. Voix du Zaire, Lubumbashi. 0425-0435 local mx //7205; F (Mayer 2/18). UNID \*0355-0425 FF(?), drums & chants; QRM. Prob Zaire (Perdue).
- 4751.5 ECUADOR. R. Centinela del Sur. 0330-0406\* mx, many ads, telephone talk pgm, nx, oftd ID as "Onda Musical" (Reeves, Miller, Mayer).
- 4755 BRAZIL. Rdif do Maranhão. 0900-0915+ PP, flute-type Andean mx, ID; QRM (Perdue).
- 4756 UNID. Af with local chorus, Swahili around 0450; poss Mozambique (Mayer 2/19).
- 4760 ASIATIC RSFSR. RR-spk 0830-1500 irreg, no mx; occ IDs as "Khabarovskij Radio" (B. Davis). (This is a wx stn, hence only a ute. BH).
- 4765 CONGO REP. RTVC. 0520-0544 FF & vernac nx, ID as "La Voix de la Revolution Congolaise (Navarre, McCoy, Sztot). 2215-2235 native mx, FF nx (Whitacre, Miller).
- 4770 LIBERIA. ELWA. 0630 BBC Af nx (Tobin). 2130-2230+ EE relig; G (Whitacre).
- 4770 VENEZUELA. R. Bolívar. 0340 SS, mx; G (Navarre). 0435-0505\* NA; late (Tuchscher'r).
- 4775 COLOMBIA. Em. Kennedy. 0315-0340 talk, relig pgm from 0334 (Tuchscherer).
- 4777 GABON. Voix de la Renovation. 2130-2300+ FF ancts, native mx, talks; G (W'acre).
- 4780 VENEZUELA. Voz de Carabobo. 0250-0300\* M6W talk, closing ancts, IDs, NA (Perdue).
- 4783 MALI. RM. \*0559 W singing to cora mx; strongest at 0715. My 100th country (Powers). 0725-0740 vernac song with strings monotonously in background, shouting "singer"; //5995 (Earhart). 2150 Af mx, 2230 FF nx, 2237 FF ID; QRM from 4788 till 2203\* of latter (McNeil).
- 4787M COLOMBIA. Ecos del Combeima. 0220 lotsa IDs as "R. Super" (as per TBS (Perdue). 0320-0350 LA mx, frequent IDs (Tuchscherer). 0440 pops, ID (Sparks).
- 4788 TURKS & CAICOS. VSI8. 2128-2220 & 2255-2313\* EE pops, rock, frequent IDs & TCs (Kusaik). On late 2/14 till 0003\*; on 2/26 soul mx, DJ yack, Mali QRM, 2203\* (McNeil). 2337-2400\* IDs as "Radio VSI, Grand Turk"; next-day sked at s/off (Jones).
- 4789 W. IRIAN. RRI, Fak-Fak. Again active this freq. Indo 1158\*; G (Willis 2/24).
- 4790 PERU. R. Atlántida. 0333 Andean & LA mx (Jones). 0455 mx; E (Navarre).
- 4795 ANGOLA. R. Comercial. \*0600 "AP," opening ID in PP; rapid FO (Sparks 3/1).
- 4795 BRAZIL. R. Tabajara. 0830-0845+ singing ads, LA mx; tough to sort out (Perdue).
- 4800 ASIATIC RSFSR. Yakutsk. HSI, Siberian version. \*0930 //4940. P sig most mornings; wiped out 1100 by Peking (B. Davis).
- 4800 ECUADOR. R. Popular Independiente. 0526 usual LA mx; 0534 ID, then ad for "Voz de la Familia" pgm (Sztot). 0712 SS mx under heavy ute (Sparks 4799).
- 4800 LESOTHO. RL. \*0400 NA, lang ancts, native relig-type songs; 0415 tent nx; 0430 FO though F at first (Whitacre 2/21). 0415 on 2/27 overpowering the Ecuadorean; Sesotho nx, ad, ID at end of nx; organ mx; 0430 FO (Sparks).
- 4800 VENEZUELA. R. Lara. 0230 SS, mx; E (Navarre). 1013 TC, mx (Jones).
- 4805 (T)BRAZIL. R. Por um Mundo Melhor. 2354 PP; het QRM (McCoy 2/27).

- 4810 S. AFRICA. SABC. 0309-0436 EE & Afkns ads, mx, IDs (Shingler, Navarre, Miller).
- 4810 VENEZUELA. R. Popular. 0225-0245 musical IDs (McCarthy). 1130-1150 M ancr, W with ads; mx. No Galápagos 1200 as reported by others; will keep trying (Earhart, M'ler).
- 4815 PERU. R. Samarón. 0430-0445 ID, bulletins, LA mx (Tuchscherer).
- 4815 UPPER VOLTA. RTV Voltaïque. 2130-2300+ FF & native mx; G (Whitacre). UnID Af 0535-0600+ vernac, chants, drums; suspect Upper Volta on early (Perdue 2/24).
- 4820 ANGOLA. Em. Oficial. 0500-0530 PP, EE vocals, nx, mention Luanda; F (Lineback).
- 4820 GAMBIA. RG. 0700 BBC nx relay; wk (Sparks 2/14).
- 4820 HONDURAS. HRCV. 0405-0445 EE nx, "Nightwatch" (McCarthy, Navarre).
- 4825 DOMINICAN REP. Voz de las Fuerzas Armadas. 2240 mixing with Peru; IDs & ads (Estes).
- 4825 GUATEMALA. R. Tesulutlan. 0030 marimba mx, relig talk in Indian lang; F (Mayer).
- 4825 TANZANIA. RT. 0400-0450 ID, Swahili nx, Af tunes; G //5050 (Mayer 2/20)
- 4826 ECUADOR. R. Luz y Vida. 0315-0335 Ec mx, W ID (Tuchscherer).
- 4832 CHINA. Shenyang, Liaoning. 1309 CC mx, singing; wk (Young).
- 4832 COSTA RICA. R. Capital. 0300-0430 pops; G (Navarre, Tobin).
- 4840 CHINA. PLA. 1149 W in CC; 1st time hrd here (Whitacre).
- 4840 VENEZUELA. R. Valera. Continuous mx for 15 mins, then ID at 0200 (McNeil).
- 4845 BOTSWANA. RB. 0356 OC, \*0358 cowbells, rooster with laryngitis; chorus to 0400, then W ID; more chorus & apparent prayer. 0402-0441 varied mx (rock, soul, '40's, etc. Plenty of QRM (Cress, Whitacre, McCarthy).
- 4845 COLOMBIA. R. Bucaramanga. 0008 (Miller), 0105-0205 (Kusalik), 0315 (Navarre), 2330 (McNeil), mx, ancts, IDs, Tcs, etc. 11).
- 4850 DOMINICAN REP. R. Clarín. 0145-0200 pops, ID; VG (Brunner). 0410\* early (Tobin 2/ Mauritanian). RRM. Back from 4845. Hrd 0735 (Perdue), 2220-2230 (Lineback, McNeil), AA, stringed-instr mx, chants; G. due, Sparks).
- 4860 PERU. R. Chinchaycocha. 0406-0558\* LA & Andean mx, ID at s/off (Tuchscherer, Perdue).
- 4860 (T)PERU. R. Callao. 0655 LA & Peru mx, mention of Callao (Perdue 2/24).
- 4860 VENEZUELA. R. Maracaibo. 0330 SS nx; G (Navarre).
- 4865 AZORES. Em. Reg. dos Açores. 2120 PP talk, 2130 ID, then pops; 2200 nx(?). 2316 RG, still there in QRM on 2/23. On 3/7 full ID 2230 along with beep or bell (McNeil).
- 4865 BRAZIL. RC do Para. 0302 PP ID (McCoy). 0803 sev IDs, mixing with another Latin (Perdue). (T)0815-0835, conceivably Azores but mx sounded Braz (Earhart 2/10).
- 4865 COLOMBIA. Voz del Cinaruco. 0410 LA mx, ads; using Voz del Rio Cauca ID //4755. Seems to be a network of Colombians after midnight (local time). (Estes). 0500 notices, ID, CARACOL anct (Sparks). Old friend hrd 0900+, all night (Willis 2/9).
- 4870 DAHOMY. Voix de la Rev. \*0511-0600+, vernac, tam-tam IS, Af chants (Perdue).
- 4871 W. IRIAN. RRI, Sorong. 1136 M&W native songs; P (Whitacre). 1255 Indo talk, Oriental mx, W ancr, IS (Miller).
- 4880 VENEZUELA. R. Universo. 0235-0350 US pops, many IDs, 0358\* (Shingler). 1037 TC, LA mx; F (Jones).
- 4883 UNID. Distorted Deutsche Welle IS 0520-0524\*. Hrd on two radios (Reeves 3/8).
- 4885 ASIATIC RSFSR. Novosibirsk. 1720 RR ancts; QRM de Peking jammers 4882 (Willis).
- 4885 COLOMBIA. Ondas del Meta. 0435 mx, nx; G (Navarre). due).
- 4886, 5 ANGOLA. Voz do Zaire. 0524 OC, 0527 drums, W in PP, Af mx; past 0600 (Reeves, Perdue).
- 4887 BRAZIL. R. Pioneira de Teresina. 0835-0850 accordion & typical Braz mx (Earhart).
- 4890 PAPUA. NBC, Pt. Moresby. 1200-1330 DJ pgm, EL mx (Whitacre). (Whitacre).
- 4890 SENEGAL. Rdif du S. 0615-0620 Af chant; fading; P (Powers). 2240 FF native mx; G
- 4890 VENEZUELA. Rdif Venezuela. 0330 mostly mx, EE vocals (Willis).
- 4895 CHINA. Huhehot, Inner Mongolia. \*1600-1755\* relays RR svc whilst Urumchi/6280 has it \*1700-1855\*. How about a QSL for these? (Willis).
- 4896 MOZAMBIQUE. RCM, Beira. \*0400 chimes, W in PP, rock mx; rapid FO (Sparks).
- 4900 VENEZUELA. R. Juventud. 0145 talk, mx; VG (Navarre).
- 4900 UNID. 0430-0450+ FF(?), Central Af mx; unbelievable level. Chad off freq? (Perdue).
- 4904, 5 CHAD. RNT. 2105 native mx, FF ancr (Estes). 2200 FF ID; P (Whitacre).
- 4905 BRAZIL. R. Relógio Fed. 0015-0030 PP ID, almost Af-type local mx (Perdue).
- 4906R COLOMBIA. Em. Atlantico. Back irreg. 0120 F-G, gone 0222. Another day 2315 SS nx; VG (Reeves).
- 4910 ECUADOR. Em. Gran Colombia. 0045 sports coverage(?) (Perdue). 0550-0556\* LA mx, M DJ; off without NA. On edge of multi-chnl tele; can't always hear EGC (Szot).
- 4910 ZAMBIA. RZ. 0435-0500 lang & EE, IDs, Af chants (Lineback, Mayer, Perdue, Sparks). 1800 vernac ID (Willis).
- 4915 BRAZIL. Which one? 0925-0945 FO, mx, M in PP with laughter (Field).
- 4915 GHANA. GBC. 0605 EE nx (Heraghty). 2100-2300\* native lang, mx (Whitacre).
- 4920 AUSTRALIA. ABC, Brisbane. 1200-1300+ DJ show, pops (Whitacre).
- 4920 UKRAINTIAN. Kiev. 2100 Moscow IS, nx in Euro lang; P (Estes). Cress, Sparks).
- 4923, 5 MOZAMBIQUE. RCM, L.M. 0335 rock, EE ancr; 0400 EE & PP IDs; //3265 (Whitacre, Perdue).
- 4925 MANCHURIA. Harbin. \*0840 long anthem, then Peking ID ("Chungyang JKT"); CC to 0900, then KK to 1000, then CC again. Relays Peking to 1700, then has local pgm in CC to at least 1830 //5950 (B. Davis). 1318 M in CC; extremely strong (Young).
- 4930 DOMINICAN REP. R. Mil. 1027 M rattling along in high gear in SS; ads, etc. (M'ler).
- 4930 ECUADOR. R. Casa de la Cultura. 0405-0412\* Ec mx; close after 4 chimes (Tuchscherer, Price). 1100-1245 mix Indos on 4927 & 4932 (Willis).
- 4930 VENEZUELA. Voz de la Fc. 0055 light mx, US pops, IDs, ads; VG (McNeil).
- 4932 JAVA. RRI, Surakarta. 1110 local ID; strong in Denpasar (Padula 2/18).
- 4932 NGERIA. NBC, Benin City. 0440-0450 EE, morning prayer; P (Mayer).

- 4935 PERU. R. Tropical. \*1049-1054V with NA, Peru mx, M ancr, TCs, IDs, long string of ads past 1112 (Reeves).
- 4940 ECUADOR. R. Nac. 0350-0400V Andean mx; P (Mayer).
- 4940 IVORY COAST. RTV Ivoirienne. 0652-0797 FF talk or speech, followed by another one; F with QRM (Shingler). 2100-2330+ FF, native mx, singing; G (Whitacre).
- 4940 VENEZUELA. R. Yaracuy. 0145 SS, mx; VG (Navarre). 1032 SS, LA mx (Jones).
- 4945 COLOMBIA. R. Colosal. 0450 SS, mx; E (Navarre). 0559:30 "Noticias del Momento" by W, then into mx 0603; G (Sztot).
- 4950 VENEZUELA. R. Coro. 0003-0010 (Shingler), 0038 (McNeil), US pops, clas mx, TC, ID.
- 4955 COLOMBIA. R. Nacional. 0300 SS, mx, mx; E (Navarre).
- 4960 VENEZUELA. R. Sucre. 0110 talk, ID, LA mx (Perdue).
- 4960 UNID. 1245-1303 CC or similar, W talk, CC-like Asian vocals by W; 1300 ID not QRE, into mx; F. Nothing listed (Lineback). (Probably Peking in JJ, BH).
- 4965 COLOMBIA. R. Santa Fé. 0200-0220, ID on hour, then short talk with lots of laughter; VG (Moritz). 0330 SS, mx; E (Navarre).
- 4970 ANGOLA. RC de Cabinda. 0606-0613 PP mx, then mx; not found of 5033 and had been reported moved here. Other 60M Angolans also noted (Young 3/3).
- 4970 VENEZUELA. R. Rumbos. 0345 SS, mx; E (Navarre). 0615-0635 Sat. (WRTH says 0500\*) (Earhart). 2300 M&W vocalists; F (Levy).
- 4972 CAMEROON. R. Yaoundé. 0512 vernac talk, 0530 EE talk, nx(?) (McNeil). 2200-2300 FF, native mx; P-F with RTTY QRM on high side (Whitacre).
- 4972 FR. GULANA. ORTF. 1010 in FF; strong het from Rumbos (Young).
- 4980 GHANA. CBC. 2230 pops, orch mx, EE, relig talk, ID as "GBC-2"; G (Whitacre).
- 4980 SWAZILAND. Swazi Music R. 0415-0510, "SMR" ID, US pops; sounds just like US Top 40 (McCarthy, Earhart, Sparks, Price, Whitacre, Shingler, Nebron).  
4980 VENEZUELA. Ecos del Torbes. 0150-0200 ads, nx, ID (Brunner, Navarre). 0522\* (Pow-  
4985 ANGOLA. R. Ecclésia. As early as 0245, mx, complete ID as per WRTH/75 hrd 0410 (Field). 0543 PP pop mx, M ancr past 0601 (Young).
- 4985 SULAWESI. RRI, Ujung Pandang. Dominant in morns around 2340 with local ID. WRTH/75 shows s/off at 0030, but actually runs to 0100\*, then goes to 9510 (Padula).
- 4990 CHINA. Changsha, Hunan. 1437 CC mx, W & such; G (Sztot).
- 4990 NIGERIA. NBS, Sogunle. 0530-0610 local mx pgm, ancrs in local lang, EE ads & nx (McCarthy). 0645-0658 mx, ads, EE (Earhart). 2203-2306\* EE, nx (W'acre, Kusalik).
- 4990 VENEZUELA. R. Barquisimeto. 0045-0055 mx, ID; RTTY (Shingler). 0345 mx, some EE vocals (Navarre). All Barquisimeto stns noted past their bedtime on 3/3. M reading speech, then NA at 0519\*; G (Powers).
- 4995 ECUADOR. (T)Ondas Azuayas. 1102 SS mx, ads, nx with many ancts "Atencion Quito; Ec-style mx. Didn't sound like Peru (McCoy 3/3).
- 4996A PERU. R. Andina. 0534 SS, pops, TC & ID; G (McCoy). 1100 various morns; Andean mx, much WWV QRM; fades by 1130 (Field).
- 5005 (T)PERU. R. Jasn. 0015-0135 LA mx, US pops; strong QRM (Tuchscherer). (T) 0238 mx pgm, 0305-0335 talk (prob nx); no ID hrd (Field).
- 5005 SARAWAK. RMS, Sibn. 1328 vernac (Young). 1430 request pgm of Malay mx in local lang; 1500 final ID "Inilah Radio Malaysia, Kuching." (Sparks). (Willis).
- 5007.5 NEPAL. RN. Back on this freq; hrd 1345 in presumed Nepali //3425/1345; RMS QRM
- 5010 CAMEROON. R. Garoua. 0532 native mx, 0546 & 0601 IS (flute/tamtam?) followed by ID in FF. Again 2158\* with seeming NA; P-F with Peru QRM (Cress).
- 5010 COLOMBIA. R. Surcolombiana. 0656 ID, mx, ancts (Young).
- 5010 PERU. R. Eco. 0440-0517 EL Peru mx; no Colombia sev nights (Field, Cress, Linebk).
- 5010 SINGAPORE. RS. 1200A EE by W, native mx; wk (Whitacre).
- 5015 ASIATIC RSFSR. Vladivostok. 1200-1300 RR daily (Whitacre). 1246 presume RR (Jones).
- 5015 GRENADA. RG. 2230-0030\* EE nx, rock, pops, C&W (Whitacre, Shingler, Russell).
- 5020 NIGER. ORTN. 0549-0634, 0706-0715 FF & vernac, native rhythms; not QRK other //s (Earhart). 2200-2204\* FF ancts, native mx; VP (Whitacre).
- 5025 PERU. R. Quillabamba. 1058-1110 \*NA, IDs, talk (Tuchscherer).
- 5030 ANGOLA. RC de Cabinda. 2230 PP ancts, pops; F (Whitacre) (Pre-4970 move? BH).
- 5030 DOMINICAN REP. Voz del Papagayo. 0620 SS & LA tunes, 0629 ID (Young).
- 5030 VENEZUELA. R. Continente. 0200 SS, mx; G (Navarre). 0430 SS, mx (Lausevich).
- 5035 BRAZIL. R. Anhanguera. 0335-0403\* Braz mx & US pops, 3 muddled IDs (reeves).
- 5035 KAZAKH SSR. Alma-Ata. 1227 IS, 1230 RR talk; F (Whitacre). (Neil).
- 5038 CENTRAL AF. REP. RNC. 2130-2300\* FF, native mx; TC & NA at s/off (Whitacre, Mc-  
5039 BURMA. BBS. 1140-1220 indigenous mx (instr & voc), talk by M&W in lang; 1200 ID in lang //4725; fluttery, VP. My country 1125 (Cress 3/5). 1510-1520 EE, piano (Neb'n).
- 5040 GEORGIAN SSR. Tbilisi. 1750 RR-type lang; G (Willis 2/23).
- 5040 PERU. R. Libertad de Junín. 0410-0503 Andean mx, IDs (Tuchscherer, McNeil).
- 5047 JAVA. RRI, Yogyakarta. \*0100, IDs and local ID; G in Denpasar (Padula 2/19). 1130 native mx, 1229 something like a rooster crowing sev times, then W ID (Whitacre).
- 5050 TANZANIA. RT. 0400-0435 drums, Swahili ID, nx, Af mx //4825; 0435 FO (Mayer).
- 5050 VENEZUELA. R. Mundial. 0055 (McNeil), 0140-0155 (Tuchscherer), 1023 (Jones), LA mx, TCs, ads, clear IDs; usually has utr QRM (McNeil, Tuchscherer, Jones).
- 5052 SINGAPORE. RS. 1530-1540 EE nx (Nebron). 2330 EE nx by W //5010 (Padula).
- 5060 ANGOLA. RC de Huambo. \*0458 choral "AP," 0459 PP, ID, pops, nx; 0615 FO (Sztot, Sparks, B. Davis).
- 5060 ECUADOR. R. Progreso. From 0400 with "musica ecuatoriana" (Field). 0405 SS, mx; excellent for 5 KW (Navarre).

- 5070 ECUADOR. R. Jesus del Gran Poder (assumed). 2355-0031 Latin mass, choral mx every 2-3 min, then M in SS past 0045 with recap & analysis, hi. Hrd 3/8 on usual Fri.-only pgm; hvy QRN; P (Reeves).
- 5075 COLOMBIA. R. Sutatenza. 0120-0145 ID with QTH, nx //5095 (Moritz, Shingler). 2230+ SS ancts, LA mx; G (Whitacre).
- 5090 CHINA. EE 1200-1255 in SSB, so presume feeder or some such (Willis 2/15).
- 5125 CHINA. RP. 1120 CG by W; F (Lineback).
- 5170 CHINA. PLA. 1123-1128 CC orch mx, W //5170; F (Lineback).
- 5290 ASIATIC RSFSR. Krasnoyarsk. Local ID finally hrd 0115 on 2/2; continued with local pgm to 0200, then back to Moscow. Usually P here, but relay occasionally G around 0000-0200 (B. Davis).
- 5310H CUBA. Cf March LR-A. Item should have been credited to Perdus, not Reeves (BH).
- 5320 CUBA. Voz de Cuba. 0750-0805 Cuban light mx. Is this harmonic? Doesn't fit image formula. Perhaps 4 X 1330 (Reloj Nacional)? (Earhart).
- 5492 ASIATIC RSFSR. RM HS here 1200-1400, almost SSB but like 3960. Feeder? (Willis).
- 5545 CHINA. RP. \*1300 Indo //8345; G (Willis).
- 5825N BANGLADESH. RB. 1600-1630 Hindi //7385. Odd freq (Willis 2/27).
- 5875 HONDURAS. Voz de H. 0208-0255 fast SS talks, mx interludes, clear ID (Fino).

With business continuing to slack off as we leave the DX season behind, this might be a good time to review our reporting procedures for the benefit of new members (and a few not so new). Your adherence to our format makes the editor's job easier and also, in the long run, means that you'll get your copy of Frendx faster. Please observe the following when you report to Section A:

- ### Make sure your report gets in the mail to reach me no later than the 15th.
- ### Include only items in the 1605-5899 kHz range.
- ### Don't report utility stations or harmonics, just SWBC. (Harmonics can be reported if identifying them clears up confusion about SWBC, however.)
- ### Although it is not necessary that items be in strict frequency order, they should be grouped according to the first digit in the freq (i.e., 2-3-4-5).
- ### If your report contains ten or more items, please cut them apart before submitting. (Fewer than ten, too, if you want to.)
- ### Put your last name at the end of each item -- they are cut apart, so there's no way we can identify the reporter otherwise.
- ### If you have to print, take care to make it legible. No hieroglyphics, please!
- ### Use only standard abbreviations.
- ### Follow the editorial format of LR-A: times first, then languages, then content, then parallels, then quality of reception. Rearranging items takes more time than any other single step in the editorial process.
- ### Particularly in the case of Latin-American stations, try to include specific details. Endless listings of "LA mx, SS talk" become stupefyingly dull after a while!
- ### It is not necessary to specify a man announcer or, in the case of IA's, Spanish language. These can be assumed unless otherwise stated.
- ### Use paper 8" or 8½" wide. Odd-size paper causes problems.
- ### Leave the equivalent of one typewriter space between items -- and try to keep the amount of vertical space they consume to a minimum. The bigger, physically, an item is, the harder it is to sort and mount, and it gobbles up a lot of space. An ideal item size would be about 8" wide by 1" high -- obviously dependent on the nature of the item, of course.
- ### In general, try to report what you consider your best DX each month. Let's keep our quality of loggings #1 among clubs!

73, good DX -- CU next month,

*Bob*

# LOG REPORT

EDITOR:

M. R. LEONHARDT  
P. O. BOX 13  
LIBERTY, IND. 47353

Deadline: 12th of month

## Section B

5900 - 11599 kHz

- 5900 ISRAEL IBA; 2005-2055\* EE, "Jerusalem Calling" (Moritz, Fields); 2210 FF px (Zilmer)
- 5905 USSR (European or Central Asian); f/i 0130-0300\* HS, all RR (B. Davis)
- 5930 CZECHOSLOVAKIA R. Prague; 0450 SS, nx, mx //7345 (Young); 0140-0154\* EE, DX px (Brunner)
- 5930 USSR (Unknown far east site); often from 0900-1000, HS Mayak px (B. Davis)
- 5935 LATVIAN SSR; 2145-2200\* Latvian, talks and songs (Mayer)
- 5945 UZBEK SSR R. Tashkent; 1630 in AA //9550, 7145 (Willis-Austi)
- 5951 COLOMBIA R. Super de Medellin; 0040 SS, nx and cmntry (Young)
- 5955 USA UN Radio; 0845-0900 EE, summary of Cyprus debate, thanking VoA for use of transmitter site (Moritz)
- 5955 BRAZIL R. Gazeta; 2036 PP, ID (Young)
- 5960 MOROCCO RTM; 2357 AA, mx and talk (McCoy) / (Hauser)
- 5965 ENGLAND RCI; 0313 IS audible under SBC, via Daventry before repeat of RR px
- 5965 MALAYSIA Kuala Lumpur; Malay svc noted until about 0400 (11AM lcl) f/o reappears about 0800 (Padula-Indonesia) / (Zilmer)
- 5965 BRAZIL R. Guaiba; 0922-1000 PP, talks, mx (Earhart, Jones); 0000 PP talks
- 5965 SWITZERLAND SBC; 0145-0415 continues to use this freq for NA, announces it as '5970' even after more than three months after shift (Hauser); 0345 II (Jones)
- 5965 HUNGARY R. Budapest; 2245 EE, DX px (Zilmer)
- 5970 BORNEO RRI Banjarmasin; \*0358, native instrument IS, RRI theme mx, lcl ID, Indonesian pops (Padula-Indonesia)
- 5970 ECUADOR HCJB; \*0230-0245 EE, DX Party Line px (Brunner, Fino)
- 5970 DOMINICAN REP RTV Dominicana; 1034 SS, nx (Jones)
- 5970 PERU R. El Sol; 1055 SS, Peruvian style mx (Zilmer)
- 5975 CHINA R. Peking; 1128 KK talks by OM&YL, KK ID (Russell)
- 5975 ENGLAND BBC; 0035-0100 EE, religious talk, organ mx (Fino)
- 5980 USA KGEI; 0915 RR rel px (Padula-Indonesia)
- 5980 SOUTH AFRICA Radio RSA; 0300 EE, nx, cmntry (Zilmer, Navarre, Fino); \*2000 FF to Eur, NF ex 15155 (Padula-Austi)
- 5985 ARGENTINA R. Splendid; 0535 SS, talks, mx (Fields)
- 5987 CELEBES RRI Menado; 0850 lcl ID, TC and wave length anmt (Padula-Indonesia) 1406 Indonesian, oriental, pop, and Hawaiian mx (McCoy)
- 5990 JAPAN NHK; 1200-1230 EE, nx, cmntry (Patterson, Navarre)
- 5995 AUSTRALIA RA; 1202 EE, nx and ID (Patterson)
- 5995 MALI R. Mali; 2214 Vern talks, native mx (Earhart); 0701 FF, ID (McCoy)
- 5995 VATICAN Vatican Radio; 0100 EE rel talk into FF 0130 (Fino)
- 6000 HUNGARY R. Budapest; 0300 EE, nx, mx, features (Zilmer, Moritz)
- 6000 SINGAPORE R. Singapore; 2230-0100 CC svc (Padula-Indonesia) / (Padula-Aust)
- 6000 PORTUGAL DW, Sines; 2130 Bulgarian, nx, ex 6170, but heavily jammed
- 6000 BRAZIL R. Inconfidencia; 0906 PP, mx, ads, ID (Earhart)
- 6005 AUSTRALIA RA; 1230-1323 EE "Kieth's Corner" px (Miller, Jones, Zilmer)
- 6005 ENGLAND BBC; 0340-0450 SS, anmts, music (Fino)
- 6006 COSTA RICA R. Reioj; 1141-1153 SS, LA pop mx, many ID's (Patterson)
- 6010 ITALY RAI; 0145-0208 II talks, mx interludes (Fino)
- 6010 W. GERMANY DW; 0145 GG, nx, anmts, mixing with RAI (Fino)
- 6015 DODECANESE ISLANDS VoA Rhodes; 2140 EE interview for Eur (Estes); 0555 EE, mx (Fields) / (Behr, Jones)
- 6015 PARAGUAY Emis Paraguay; 0900 solid hour of ads, SS nx and mx to 1030
- 6015 BRAZIL R. Clube Pernambuco; 0903-0925 PP, songs and ads (Earhart) / Zilmer'
- 6020 VENEZUELA R. Anzoategui; \*1000 SS, NA, ID the "Musica Nacional (Jones,
- 6020 HOLLAND RN; 1940 EE to Eur, add'l freq //to Talata, same px (Padula-Austi)
- 6020 NETH ANTILLES RN; \*2130-2255 DD OM & YL in talks (Fino)

- 6025 UZBEK SSR R. Tashkent; 1400 EE, nx, cmntry (Navarre)
- 6025 PORTUGAL R. Portugal; 2315-2330\* PP to Brazil; NF this time period; this station has made extensive rearrangements to sked recently, nothing like that in WRTH-75 (Padula-Austl); 2340-0002\* SS px; on irregular sked (Behr); 0240-0300 EE, new time for NoAmer svc. (Miller, Jones, Brunner)
- 6025 PARAGUAY R. Nacional; 0930-1027 SS "R. Nacional del Paraguay" ID, talk mx (Jones, Earhart)
- 6035 BOLIVIA R.P. americana; 1005-1105 SS, vocals, ads (Earhart, Hanner-Austl)
- 6035 BRAZIL R. Globo; 0150-0210 PP, LA mx, ID, nx (Tuchscherer)
- 6035t RSFSR Vladivostok; 1152-1216 RR, OM&YL in talks, time pips 1220 followed by YL saying "Govorit Vladivostok!" (I think), then OM&YL alternating news items (Patterson)
- 6040 COLOMBIA LV del Toima; 1005 SS (Willis-Austl); 0221 SS ID by YL (Young); 0300 SS, news (Navarre)
- 6040 E. GERMANY RBI; 0300-0345 SS ID, nx, cmntry (Lineback, Brown)
- 6045 JAVA RRI Jakarta; 0850 overseas CC svc (Padula-Austl)
- 6045 NETH ANTILLES TWR; 0330 Polish to Eur/MidEa (Brown); 0435 EE nx (Navarre); 0425 CS talk and mx (Zilmer)
- 6045 SWITZERLAND SBC; 0430 EE, talk on winter sports (Levy)
- 6054t BRAZIL R. Clube Paranaense; 0840 definitely PP, ads, OM in talk (Earhart)
- 6055 CZECHOSLOVAKIA R. Prague; 0055\* end of EE px (Tuchscherer); \*2300 EE ID then into lang (Zilmer)
- 6050 YEMEN(Rep) R. Sanaa; 2143 AA, nx, chants, ID and anthem to 2200\* (Behr)
- 6060 RSFRS Khabarovsk; \*1900-2000 f/o w/R. Moscow relay (B. Davis)
- 6060 ARGENTINA R. Nacional; 1010-1025 SS, classical piano mx, ID by OM (E'hart)
- 6065 COLOMBIA R. Super, Bogota; 1140-1154 SS, "Hora Super" ID's, nx, TC's (Patterson); 0440-0510 SS, mx, amnts, clear ID (Fino)
- 6065nf ECUADOR HCJB; 1200 EE segment ending JJ px Sundays; ex 6170 (Hauser)
- 6065 SPAIN RNE; 0210-0239 EE, nx, mx, ID's (Brunner, Fields)
- 6065 SWEDEN R. Sweden; \*2245 SS, YL w/nx (Mayer)
- 6068 UNID. 1015-1025 probably R. Condor, Bolivia; het RRI 6070 (Hanner-Austl)
- 6070 ECUADOR R. El Mercurio; 0230-0300 SS, good till VoA s/on 0300 (Navarre)
- 6070 VENEZUELA R. San Sebastian; 1045 SS, many ID's (Zilmer); 0355 SS, LA mx, ID, NA and s/off 0357\*(Miller); noted till 0520\* 3/3 (Behr)
- 6070-72v SWAZILAND TWR; 0330 Zulu; 0400-0430\* GG px (Behr, Lineback); 0359 EE ID into Afrikaans 0400 (Miller, Russell)
- 6080 BELGIUM RTB; 0000 DD, 0020 FF, 0041-0100\* EE px (Behr); replaces 6055 (Zilmer) / (Behr)
- 6080 KIRGHIZ SSR R. Moscow via Frunz; 1330 S Asian lang; 1500 EE, QRM RR HS
- 6080 UNID. 2200-2216, possibly Soviet, plaintive songs, short talks (Tuchscherer)
- 6085 BRAZIL R. Jornal do Comercio; 0045 PP talks (Zilmer)
- 6085 COLOMBIA Ondas del Darien; \*1152 NA, ID's in SS and EE (Jones)
- 6085 CANADA DW via Sackville; 0220 GG, operatic arias (Miller) / (Earhart)
- 6090 AUSTRALIA VLI6 Sydney; 1200-1300 EE, nx, orchestra and vocals (Zilmer)
- 6090 NIGERIA RTV Kaduna; 2140 Hausa w/chants // 9570 (Mayer) // (Jones)
- 6090 LUXEMBOURG RL; 2300-2315 GG, pops, ID's (Brunner); 0002 EE, R&R mx
- 6090 ARGENTINA R. Belgrano; 1055 SS, talks, mixed mx (Zilmer)
- 6095 SPAIN RNE; 0100-0347\* EE px 3/8 only, back to 6065 next day (Behr)
- 6095 PERU R. Nacional; 0400-0504\* SS, orch mx, nx off w/anthem //9562, now relays MW 854, not 1080 (Behr)
- 6095 PHILIPPINES VoA; 2230 EE, "Breakfast Show" (Courtney)
- 6095 SPANISH SAHARA R. Sahara; 2150 AA mx, 2200 SS ID, talk and mx, 2300 SS nx, mx and "Viva Espana" to 0000\* w/anthem (Behr); -BBC WR Club 2/19 says R. Sahara here at 2000, after leaving 11805 at 1800, in AA until 2200\*, I have not heard the new outlet but suggest that some reports of Mogadishu, Somali Rep at this time are in error (Hauser)
- 6100 MALTA DW; 0115 IS, EE ID, "Records Request" px (Price, Fino); 0221 GG operatic arias (Miller)
- 6110 PARAGUAY R. Charitas; 0940-1004 SS, LA songs, TC's, fair carrier weak modulation (Behr)
- 6110 ENGLAND BBC; 2135 SS, nx, talks, into PP at 2200 (Fino)
- 6115 COLOMBIA LV del Liano; 1045 SS, talks, LA mx (Zilmer); 0236 SS ID (Estes)
- 6115 PERU R. Union; 0245 SS, talk by OM, then LA mx (Tuchscherer)
- 6116 CONGO Rdiff Congolaise; 2230 FF, Afr mx, FF/Vern talks (Zilmer)
- 6120 SWITZERLAND SBC; 2300 PP, ID, Swiss mx, nx, amnts (Fino)
- 6120 VENEZUELA R. Angostura; 1100 SS, talks, mx, ads (Zilmer)

- 6125 HONDURAS R. Suyapa; 0548 SS, 1cl nx, comment, s/off 0556\* (McCoy)
- 6130 GHANA R. Ghana; 0727 EE, nx by OM (Shingler)
- 6130 CANADA CHNX Halifax; 1145-1201 EE, NHL scores, nx, wx, quiz (Patterson); 2310-2330; 0015 EE, pops, car ads (Tuchscherer, Shingler)
- 6130 ECUADOR HCJB; 0715 EE rel px to Eur (Fields)
- 6135 ALBANIA R. Peking via Tirana; IS heard under jammer into lang \*2300 (Zilmer)
- 6135 CHILE R. Universidad de Concepcion; 1030 SS, talk, classical mx (Zilmer)
- 6140 AUSTRALIA VLW6, Perth; 1035 EE, "Sporting Roundup" (McCoy); 1202-1213 EE, Western Australian nx, then pop mx (Patterson)
- 6140 BRUNEI LV de la Revolution; 0445 all 1cl mx, talks in lang (Tuchscherer)
- 6140nf RUMANIA R. Bucharest; 2200-2225\* GG px //5990, 7225 (Behr)
- 6140nf ECUADOR HCJB; 0715 EE to Eur, ex 6130 (Padula-Austl)
- 6145 NIGERIA Calibar; 0628 Vern songs, Afr mx (Young)
- 6145 ALGERIA RTVA; 2100 AA, AA mx, chants, ID (Miller)
- 6145 W.GERMANY DW; 0159 EE, end of DX px into GG px (Jones); 0222 GG, operatic arias (Miller); 0330 GG, talks (Navarre)
- 6150 COLOMBIA Voz del Huila; 0215 SS, mx, many ID's (Navarre)
- 6150 AUSTRALIA VLR6; 1020; 1358 EE, ABC nx, time pips (Levy, Mayer)
- 6150 ENGLAND BBC; 2315 (6:15AM 1cl) w/Asian langs (Padula-Indonesia)
- 6155 SWAZILAND Swazi Music Radio; 0400 EE, ID's, pop mx //4980 (Behr)
- 6155 BRAZIL R. Cultura da Bahia; 0100 PP talks (Zilmer) / Courtney
- 6155 AUSTRIA ORF; 0130-0200 EE, nx, cmntry, classical mx (Earhart, Price, Jones)
- 6155 SINGAPORE R. Singapore; \*2130 into Malay svc w/px preview; has obviously increased power on this outlet (Padula-Austl)
- 6155 JAPAN AFRTS Far East Network; 1300 EE, nx, mx (Navarre)
- 6160 W.GERMANY DW; 2228 PP ID into px for Brazil (Courtney)
- 6160 VENEZUELA R. Canaima; 1006-1030 SS, Kellog comm'l (Zilmer, Jones)
- 6160 COLOMBIA Emis Nueva Grenada; 1123 SS, LA mx, RCN px (Jones); 0130 SS, talks, mx (Navarre)
- 6165 VATICAN Vatican Radio; \*0100 EE, rel px (Levy, Zilmer, Navarre, Talbot)
- 6165 BRAZIL R. Cultura Sao Paulo; 2355 PP, YL&OM in talks (Zilmer)
- 6165 SWITZERLAND SFG; 2100 EE "Datefile" px (Zilmer)
- 6165 NETHERLANDS ANTILLES RN; 0155 EE, nx, mx (Navarre)
- 6170 COLOMBIA LV de la Selva; \*0918; 1045 SS, ID, LA mx (Zilmer, Jones)
- 6170 VENEZUELA R. Nacional; 0305 SS, nx, mx (Lausevich) / Miller
- 6170 MOROCCO RTM; 2045-2230 AA, chants, ME mx, talks (Zilmer, Tuchscherer, England)
- 6175 ENGLAND BBC; 2240 EE, nx Big Ben tolling (Fino)
- 6175 FRANCE RFI; 0625 FF talks, US pops (Fields)
- 6175nf USSR R. Moscow; 0600 now here w/HS //7120 (Willis-Austl)
- 6180 GUATEMALA R. Nacional de Guatemala; This not a new station as reported Mar LR, has been here for decades, however if they really are programming Internationally separate from MW, it would be a new use of the old facility (Hauser); 2346 SS, LA mx (Jones); 0300 SS, talks, Marimba mx (Courtney); 0430 ancing as International svc (Zilmer); 0500 SS, talks, mx (Navarre)
- 6180 CYPRUS BBC, Limassol; 2200 EE, nx to Cent Eur (Zilmer)
- 6180 VENEZUELA R. Turismo; 1125 SS, ID, TC, LA mx (Jones)
- 6185 ALBANIA R. Peking via Tirana; \*2230 relay of Peking's Quechua svc to Bolivia is NF and an additional px for relay (Padula-Austl)
- 6190 VATICAN Vatican Radio; 2215 II, talks about Lent (Fino)
- 6190 MOROCCO RTM; 2315 AA, chants, mx (Zilmer)
- 6190t IRAQ R. Baghdad; 2145-2157 f/o w/AA talk by OM, short interludes of ME mx, all low level, this not Morocco since this outlet is // to other RTM freqs (Estes)
- 6195 NIGERIA Sokoto; 0620 OM in Vern talks, Afr singing (Young)
- 6200 ALBANIA R. Tirana; 0245 EE, nx, cmntry //7300 much better (Fino, Navarre)
- 6250 EQ. GUINEA R. Malabo; 0552- 0613 SS, march mx (could be anthem), YL in talks, vocal group, spoiled by RTTY (Earhart) / (Willis-Austl)
- 6259.5 PAKISTAN R. Pakistan; \*1400-1630\* On this freq, sometimes EE nx 1600
- 6270nf CHINA R. Peking; 1500-1555 RR, jammed (Willis-Austl)
- 6305 UNID. 1600-1730 plus, mainly EE, apart from 1615-1630, rev mx, almost SSB but not quite. Believed may be clandestine (I ran?), or even Bangladesh (Willis-Austl)
- 6320 CLANDESTINE R. Liberate the Southern Part; VV talks, rough sked is 1200-1245; 1400-1445. Times vary, always under China, but loud (Willis-Austl)
- 6334t N. VIETNAM Tay Bac; 1000-1430\* VV, s/off varies too much to be sure of positive location (Willis-Austl)
- 6338 N. KOREA R. Pyyongyang; \*1600 in KK, 1700 AA (Willis-Austl)

- 6430nf CHINA R, Peking; \*1300-1355\* in FF (Willis-Austl)  
 6450nf N. KOREA Hanoi; 1000-1700\* VV, now here for last three weeks NOW REPLACING 6385v leaving ULAN BATOR IN CLEAR! At last a chance to hear Mongolia in ECNA (Willis-Austl)  
 6455nf N. KOREA R, Pyongyang; 1100-1400 plus JJ svc, unlisted (Willis-Austl)  
 6538nf N. KOREA R, Pyongyang; 1100-1500\* in JJ (Willis-Austl)  
 6622.5 nf N. KOREA R, Pyongyang; 1100-1500\* JJ svc (Willis-Austl)  
 6793nf N. VIETNAM Viet Bac; 1100-1400 //3991 (Willis-Austl)  
 6840 CHINA Inner Mongolia, Huhhot; 1230 CC (Willis-Austl)  
 6900 TURKEY Turkish State Meteorological Svc; 1456 TT mx and singing, possible TC at 1500, heavy het 6899 (Young)  
 6955t CHINA R, Peking; 0940 OM in lang, not CC, no mx or ID noted (Earhart)  
 6994 CHINA R, Peking; 1300-1355 RR svc here (Willis-Austl)  
 7010rf PAKISTAN R, Pakistan; \*1330-1500\* now back w/lower power (Willis-Austl)  
 7080 CLANDESTINE (?) Radio Cuba Libre; Noted 3/7 0038 w/military mx, OM in SS many ID's this is not usual R, Habana style, much of tirade translates to anti Soviet; possibly a "Black" clandestine operating out of Peking. Anyone know for sure? (Rockwood)  
 7085 PAKISTAN R, Pakistan; \*1800 in TT, then Sylheti (Willis-Austl)  
 7100 MONACO TWR; 0835 EE, hymns, ref talk. Definately 7100 not 7105 (Earhart)  
 7105 SPAIN RNE; 1115-1145 SS, on early w/mx, talks, ID. Also noted 0950-1012 in European lang px not listed WRTH or station skeds (Earhart)  
 7110 MALI R, Mali; \*0800 on Sun in FF // 11960, 9635 (Willis-Austl)  
 7120nf BANGLADESH R, Bangladesh; 1200-1210 EE, then Bangla (Willis-Austl)  
 7120t CLANDESTINE Red Army Radio; 1420 short CC emphatic b'cast (Willis-Austl)  
 7122.5 CHINA R, Peking; 0345 EE, slightly off freq to avoid RM 7120 (Earhart)  
 7135t GABON Rdiff Television Gabonaise; 0715-0735 FF, string mx, no clear ID, so possibly could be TWR Swaziland (Earhart)  
 7150 UKRAINIAN SSR R, Kiev via Simferopol; 0030 EE, nx, talk on schools (Slaff)  
 7165 RYUKYU ISLANDS VoA Okinawa; \*1059 EE nx (Jones)  
 7170 UKRAINIAN SSR R, Kiev; \*0000-0030 EE, political talks (Fields)  
 7170 NEW CALEDONIA R, Noumea; 0633 FF, US and FF pops (McCoy); 0756 FF, talks and US pops (Fields); 0955-1010 FF, soul and pop mx, ID (Earhart)  
 7200 ENGLAND VoA Wofferton; 0530-0600 EE, "Breakfast Show" (McCarthy)  
 7200t RSFSR Vladivostok; 0839 RR, mx (Fields) 1011 light or semi-classical mx, continuous without ID or talk (Earhart)  
 7200 USSR R, Moscow; 0335-0420 EE, political talks, much QRM (Fino) / (Jones)  
 7205 USSR (Unknown station); \*1300 lang not RR, but "Moskva" on opening anmt  
 7205 ZAIRE R, Lubumbashi; 0424-0435 Vern talks, lcl mx //4750 (Mayer) / (Miller)  
 7215 BRUNEI R, Brunei; 1059 possible IS on string instruments, OM in lang talks  
 7215 IVORY COAST Rdiff Television Ivoirienne; 0732 FF/Vern, native mx, some ARO QRM (Earhart)  
 7220 AUSTRALIA RA; 1155 EE nx to Papua/New Guinea (Zilmer)  
 7225 INDIA AIR, Delhi; 0145-02 05 Nepali xmsn w/lcl mx and vocals. 0200 ID and probable nx by YL (Estes)  
 7235 NIGERIA Enugu; 0623 OM&YL in Vern talks (Young)  
 7245 ANGOLA Em Oficial, Luanda; 0459 PP, opening ancmnts, then "A Portuguesa" (McCoy, Miller)  
 7245 S. VIETNAM Saigon; 0830 VV svc (Padula-Indonesia)  
 7245 MAURITANIA Rdiff Nat de Mauritanie; 0925-0935 AA, long song by high pitched YL, string mx before possible nx by OM (Earhart) / (Earhart)  
 7252 GUINEA (Rep) Rdiff Nationale; 0513 Vern, Xylophone mx, native singing  
 7255 RSFSR Vladivostok; f/i 0830-100 wipe out VoA HS in RR, Far East version (B. Davis)  
 7260 USSR R, Moscow; 0830 JJ svc //7285 (Padula-Indonesia)  
 7265 GREECE VoA Kavala; 0530-0600 EE, "Breakfast Show" (McCarthy)  
 7270 SOUTH AFRICA Radio RSA; 0415 EE, nx, mx (Zilmer)  
 7270 POLAND Polish Radio; 0640 EE, "Post Bag" px (Levy)  
 7275 NIGERIA VoN; 0702 EE, nx, ID (Earhart, Shingler, Fields)  
 7275 PHILIPPINES VoA, Poro (Listed); 1344 VV px //6020 (Young)  
 7280 LIBERIA VoA Monrovia; 0530-0600 EE, "Breakfast Show" (McCarthy)  
 7280 USSR R, Moscow; 0845 JJ talks and nx (Fields)  
 7290 MALTA RCI; 0715 EE nx into FF 0720 (Earhart)  
 7290 USSR R, Moscow; 0105 EE, nx "Mailbag" px (T. Smith) / (Estes)  
 7300 UNID. 1630-1700 low level OM talking in lang, chimes 1630, maybe Dushanbe  
 7300 ALBANIA R, Tirana; 0210 EE, news, songs (Fino)

- 7300 YEMEN(Rep) R Sanaa; 1600 AA, "V of Palestine Revolution", not Iraq as reported in Feb. LR (Behr)
- 7300 USSR(Asian) R. Moscow; 0726-0730\* EE cmntry, probably Kenga (Young)
- 7305 USSR R. Moscow; 1500 Farsi; 1530 AA; 1630 Farsi. New powerhouse xmtr since 1/30, Caucasus or Turkistan area (Behr)
- 7315 CHINA R. Peking; 1236 CC, OM&YL w/nx (Earhart)
- 7324.5 CHINA R. Peking; 1349 CC under USSR (Willis-Austl)
- 7355 LITHUANIAN SSR R. Vinius; 2259\* ending EE pxw/freqs and ID (Russell)
- 7355 USSR R. Moscow; 0212 EE, "Mailbag" px (Hauser)
- 7360 USSR(Unknown site); \*1700 organ IS, RR anmt into RR nx and talks (Estes)
- 7360a USSR R. P. & P. \*0100-0159\* EE ID into SS px w/music and cmntry(McCarthy)
- 7380 USSR R. Moscow; 1100-1125 EE to Austi/NZ w/talk on Cosmonauts (Earhart)
- 7385nf BANGLADESH R. Bangladesh; 1600 in Hindi //5825 (Willis-Austl)
- 7395 ISRAEL IBA; 2000 EE, talks, nx (Fields); 2200 FF, talks, mx (Zilmer)
- 7425 CHINA China Press Station; 1638 nx in slow CC (Young)
- 9009 ISRAEL IBA; 2200 FF, nx (Zilmer)
- 9022 IRAN Vol; 1957 FF into EE 2000 w/nx (Zilmer, Staff); R. Iran at 0212 w/AA mx px (Fields)
- 9030 CHINA R. Peking; 0430 CC talks (Fields)
- 9250 KAZAKH SSR R. Alma Ata; 0000 anthem into Kaz and RR nx; 0015 exercises in RR //9380, 10530 (Behr)
- 9440 CHINA R. Peking; 1200-1255 Khmer px //9900, 6520, 11695, 12080 (Willis-Austl)
- 9445 CANADA CBC; 2152 EE, RCI SW Club px into Northern svx (Jones)
- 9450 RFSFR Vladivostok or Khabarovsk; \*0900-2200\* HS Malay px (B. Davis)
- 9460 CHINA R. Peking; 0935 EE, anti US talks (Earhart)
- 9480 ALBANIA R. Tirana; 2051 EE revolutionary talks (Staff)
- 9495 ISRAEL IBA; 0115 Hebrew HS relay on late w/US folk mx, reports on attack on Tel Aviv (Hauser); 2145 Hebrew HS (Zilmer)
- 9500nf E. GERMANY RBI; 0330 to WCNA ex 5955 (Padula-Austl)
- 9500nf USSR R. P. & P.; 1030 EE, nx; NF this svx (Hanner-Austl) / Staff, Fields)
- 9505 DOMINICAN REP RTV Dominicana; \*2007 piano IS, ID into SS pxing ( Miller, Staff)
- 9505 FRANCE RFI; 1710 EE px to Afr (Marcus)
- 9510 CANADA/USA; As of Mar 2, Ascension moved to 9580 for the BBC WS, and Sackville moved here from 9740 for 2300-0030. Then ala the winter operation on 6175, Greenville takes over relaying BBC WS until 0330, when Greenville ID could be detected; very poor. Ascension is used for WS to Afr 0500-0545. The BBC use of VoA apparently a tradeout for VoA use of Ascension (Hauser)
- 9515 TURKEY TRT; 1800-1851 TT, TT pop mx (Miller, Marcus); \*0358 TT HS, change in sked (Willis-Austl)
- 9515 MEXICO LV de la America Latina; 1530 SS, talks, mx (Navarre)
- 9520 FRANCE RFI; 2000 EE, "Paris Calling Africa" (Zilmer)
- 9520 NEW ZEALAND NZBC; 0915 EE, talks, mx px //11780 (Fields)
- 9520nf SPAIN RNE; \*0400 w/IS and SS ID under Kuwait (Willis-Austl)
- 9525nf FRANCE RFI; 0650 FF, cmntry(Hanner-Austl, Padula-Austl)
- 9525 INDIA AIR, New Delhi; 1800 EE, news (Marcus)
- 9525nf MONACO TWR; \*1600 in presumed Polish (Willis-Austl)
- 9525 SOUTH AFRICA Radio RSA; 2250-2310 EE, ID, nx round-up (Fino, Buccola)
- 9525 LEBANON R. Lebanon; 0235 EE, nx, Bad QRN RNE 9530 (Staff)
- 9530nf AUSTRALIA RA, Shepparton; 2100-2245 EE w/world of mx, ex 7140 (Hanner)
- 9530 SPAIN RNE; 0025 SS, nx, cmntry, mx (Fino)
- 9533.5 PERU R. Nacional, Tacna; 0320-0401\* SS, US pops and LA mx, early close w/NA (Tuchscherer)
- 9535 ANGOLA Em Oficial; 0600-0610 PP, OM in talks, no ID but many mentions of Angola (Earhart)
- 9535 SWITZERLAND SBC; 0200 EE, talks, "Swiss SW Merry-Go-Round" (Staff, Heraghty)
- 9540 NEW ZEALAND NZBC; 0715 EE, popular oodies (Earhart)
- 9540 UZBEK SSR R. Tashkent; \*1200-1230\* IS, ID into EE nx, cmntry (Russell)
- 9545 GHANA R. Ghana; 2115 EE, nx (Zilmer, Jones)
- 9545 BRAZIL R. Universo; 0945-1005 PP, talks, vocals (Earhart); 2320-0115 PP, sports, US pop mx (Tuchscherer, Zilmer)
- 9550 CUBA R. Habana; 1900 SS, nx (T. Smith); 0130 SS, OM in talks (Fino); 1115-1125 Creole, OM in talks w/musical ID 1120 (Earhart)
- 9550 UZBEK SSR R. Tashkent; 1630 AA px, not 9540 (Willis-Austl)
- 9550 NORWAY R. Norway; 2100-2130 EE, "Norway This Week" (Mayer)
- 9550 GRENADA R. Grenada; 1755-1820 EE, rel talk (Earhart)
- 9550 TANZANIA RT; 1420-1505 talks by OM in lang, children's choir (Tuchscherer)

- 9555nf KUWAIT R. Kuwait; 1945-2000\* EE to Eur, ex 9715 (Padula-Austi)
- 9560 ECUADOR HCJB; 0115-0140 EE, rel talks (Trautsohd, Fino)
- 9560 JORDAN R. Amman; 1700 EE nx (Marcus)
- 9562 PERU R. Nacional de Peru; 0730; 1130 SS, Peruvian mx, ID (Fields, Zilmer)
- 9565 CHILE LV de Chile; 0030-0050 EE, cmntry, ID (Brunner, Navarre)
- 9570 NETH ANTILLES TWR; 0830 PP, music and PP talks (Earhart)
- 9570 AUSTRALIA RA, Shepparton; 1044 EE, nx; earlier s/on now (Hanner-Austi)
- 9570 RUMANIA R. Bucharest; 0133 EE, evidence of greatly improved conditions, being audible in all of NA svc (Hauser)
- 9570 NIGERIA RTV Kaduna; 0626 drum mx, ID in Vern 0630 (Young)
- 9570-72v CHILE R. Diego Portales; 1055 SS, mx, talk, many ID's (Zilmer); 0016 SS, ads, chimes before ID (Price); 0240 SS, ID's, reading names (Lineback); 0015 SS, LA vocals (Russell)
- 9575 GREENLAND Gronlands Radio; ID in lcl lang (Mayer); 2200 Danish mx (Behr)
- 9575 YEMEN(Rep) R. Sanaa; 0357 AA, mx //5804 (Mayer, Behr)
- 9575 ITALY RAI; 1830 II to canada (Staff); 0115 EE talk on art (Heraghty); 0130 FF, nx (Navarre)
- 9580 ASCENSION ISLAND BBC; 0430\* EE WS relay moved here 3/2, ex 9510 for 2300-0430 (Hauser)
- 9580 NICARAGUA R. Mar; 1615-1630 SS, ballads, ID, TC (Mayer); 1345 SS, romantic mx (Tuchscherer); 1350 SS, rarely heard here (Young)
- 9580 BULGARIA R. Sofia; 2110 EE nx (Marcus)
- 9580 ZAMBIA R. Zambia; 1920 Vern talks, OM w/nx (Mayer)
- 9580 AUSTRALIA RA; 1130-1200 EE, nx, "Focus on Australia" (Buccola)
- 9590 NORWAY R. Norway; 1400 EE "Norway This Week" (Zilmer); 1400-1430\* Norwegian px (Behr)
- 9590 SWITZERLAND SBC; 2110 EE, "Swiss SW Merry-GO-Round" //9535 (Zilmer)
- 9595 BRAZIL R. Cultura da Bahia; 0015 PP, talks, several ID's (Zilmer)
- 9600 UZBEK SSR R. Tashkent; \*1200-1230\*; \*1400-1430\* EE, nx cmntry (McCarthy, Navarre, Russell)
- 9605nf FRANCE RFI; 0610; 0708 FF to Afr (Hanner, Padula-Austi); \*1800 FF, talks mx //9740 (Zilmer) / (Hanner-Austi)
- 9605nf AUSTRIA ORF; 1935 GG to Eur (Padula); 2148 SS anmts, orch mx, ex 9615
- 9605nf MALTA CBC; 0633 EE, nx, Third tx site for Malta (Hanner-Austi)
- 9605 VATICAN Vatican Radio; 0100 EE, YL w/rel story (Buccola)
- 9605 SWEDEN R. Sweden; 2345\* end of SS px (Young)
- 9610 AUSTRALIA VLW9, Perth; 1405-1500 EE, nx, rel talk, wx report mentioning 105° F some places (Courtney, Shingler, Moritz, Earhart, Navarre)
- 9618.3 MOZAMBIQUE RCM, L. Marques; 1430 pop mx to 1505 f/o (Behr)
- 9620 YUGOSLAVIA R. Belgrade; 2200-2215 EE, nx, cmntry (Navarre, Shingler)
- 9630nf ISRAEL IBA; 2011-2035 EE, "Israel Calling" (Miller, Padula-Austi)
- 9630 FRANCE RFI; 2000 FF, YL&OM w/nx (Miller)
- 9636 MOZAMBIQUE RCM Beira; \*1455 IS, 1500 chimes, Nyanja px to 1510 f/o (Behr)
- 9635 COLOMBIA R. Nacional; 0730; 1130; 1146 SS, cmntry, EE lang lessons (Zilmer, Jones, Fields)
- 9640 POLAND Polish Radio; 1810 ending FF nx (Marcus)
- 9645 BRAZIL R. Bandeirantes; 0025 PP ta;ks //11925 (Zilmer)
- 9650 CHILE R. Yungay; 0235 SS, talks, positive ID (Fields)
- 9650 GUINEA Rdiff Nationale; 2145 FF/ Vern talks, Afr mx (Courtney, Price)
- 9665 BRAZIL R. Nacional Brasilia; 0240 PP, talks, mx (Fields)
- 9670 PORTUGAL VoHope; 2044 EE, rel px, Pat Boone records (Marcus, Price)
- 9675 BRAZIL R. Diario da Manha; 2345 PP, talks (Zilmer)
- 9675 PERU R. Del Pacifico; 1035 tentative w/SS talks, chimes (Fields); 1215 SS, many ID's (Zilmer)
- 9680 SOUTH AFRICA Radio RSA; 1400 EE, music, news (Navarre)
- 9680 AUSTRALIA VLR9 Melbourne; 1330-1400 EE, nx, talks (Price, Zilmer)
- 9690 MALTA RCI; 1800-1830 EE, nx to Afr, ID and freqs (Moritz, Russell)
- 9690 ARGENTINA RAE; 0110 SS, concert mx (Fino); 0225 SS, mx (Lausevich); 0315 EE px (Levy); 0610 EE, nx, mx (Heraghty)
- 9695 FRANCE RFI; 2000 FF nx and mx to 2200\* //9605, 11940, Gabon relay listed 9695, but assume it's Paris (Behr)
- 9695 COSTA RICA TIFC; 0325 EE, rel px (Levy)
- 9695 BRAZIL R. Rio Mar; 0045 PP, mx, talks (Zilmer)
- 9700 BULGARIA R. Sofia; 2140 EE, nx, contest details, DX px (Courtney)
- 9700 RWANDA DW, Kigali; 2200 GG to SoAmer //15410 also announcing new 3995 freq and others (Behr)

- 9705 MEXICO XERMx; 1355 SS (Willis-Austl); 2300 SS ID via long path (Padula); 0150 SS, Fiesta mx (Trautschold)
- 9710 USSR R.P.&P.; \*1300 EE, nx and comments (Jones, Navarre)
- 9715 KUWAIT R. Kuwait; 1840-1930 EE, pops, song request px (Shingler, Moritz)
- 9720nf FRANCE RFI; 0600 now here w/FF anmts, not USSR (Willis-Austl)
- 9720nf SWEDEN R, Sweden; 0030 EE, nx //6195, replaces 6035, 6135 (Zilmer)
- 9722 SAUDI ARABIA Riyadh; 1830 AA talk, mx, ID's to 1929\* (Behr)
- 9730 E.GERMANY RBI; 1903 EE "News Reel" px (Shingler); 2000 FF, nx (Miller)
- 9730 BELGIUM RTB; 2255-2315 EE, "Belgium Speaking" (Zilmer, Courtney)
- 9735 MOROCCO VoA Tangier; 1705 EE s/off saynig Delano, but QSL from VoA said it was Tangier (Moritz)
- 9735 W.GERMANY DW; 0215 SS, talks opera mx (Fino)
- 9743.5 ALBANIA R. Tirana; 0000 EE px; 0030 RR, jammed (Behr)
- 9745 IRAQ R. Baghdad; 1815 AA px (Marcus); \*1930-2006 EE, nx, mx, features, Arabic mx (Buccola, McCarthy, Earhart, Miller, Shingler) / Moritz)
- 9750 CHILE R. Minera; 1009; 1100; 1300 SS, nx, mx, talks (Navarre, Zilmer, Young)
- 9765 W.GERMANY DW; 2100 EE, nx, cntry (Zilmer)
- 9765 ENGLAND BBC; 0400 SS, ID, nx (Fino)
- 9765 AUSTRALIA RA; 1249-1314 EE, testing Mar 8 from Nangara site (near Perth) to Indonesia w/mx, ID's. Much weaker than 9610. This series test was to conclude Mar 10. RA previously used Perth for Afr svc, but the loss of Darwin leads them reactivate Perth area txmtrs (Hauser)
- 9770nf CUBA R. Habana; 0201 new freq noted Mar 9 after Tirana off 9775 (Hauser)
- 9770 AUSTRIA ORF; 0145 EE, talk on transportation (Staff)
- 9770 ECUADOR HCJB; 0230 OM in RR, rel singing (Fino)
- 9770nf RUMANIA R. Bucharest; \*1300 EE over Vienna (Willis-Austl)
- 9770 HAITI 4VEH; 1208-1300 EE, nx, music request px (Fields, Zilmer, Moritz)
- 9775nf ALBANIA R. Peking via Tirana; 0130 EE, into Tirana IS 0159, down from 9750 (Hauser)
- 9790 UNID. 0150 EE talk on Soviet high school tutors, ended w/Internationale. Not Moscow as RM heard same time w/different px (Staff)
- 9795 USSR R. Moscow; 0125 SS, assumed FE site as fluttery, unlike Tirana relays of Peking nearby (Hauser)
- 9805 EGYPT R, Cairo; 2122 GG, GG songs into EE 2145 (Miller, Buccola, Fino)
- 9815 ISRAEL IBA; Following our recommendations moved off 9630 (high power) Mar 2 for 2000-2055 EE; 2200-2245 FF; much improved but 12025 better (Hauser)
- 9915 ENGLAND BBC; \*0500 EE, World Service to Africa (Price)
- 10056.5 N. VIETNAM Hanoi; 1000 VV anmts, ex 10068. By end of this month is down to 10052 (Willis-Austl)
- 10079 CLANDESTINE VoNUFK; Khmer anmts, runs till 1225\*, then\*1325 (Willis)
- 10110 CLANDESTINE Radio Espana Independiente; 0600-0645 SS (Willis-Austl)
- 10225 CLANDESTINE Liberation Radio; 1300 VV talks //7415 (Willis-Austl)
- 11415 CLANDESTINE R. Peyk-e-Iran; 1500 Azerb, 1531 Farsi //11695 (Behr)

o o o

First of all, apologies to Headquarters for being a couple of days late in getting this mailed, but on Friday March 14 a freak snow storm dumped eight inches of snow here in Eastern Indiana making it impossible to get to the Post Office to pick up the final reports until Monday. This being the case, the entire week end was lost as far as getting started on LR-B. Better late than never!

Bob Padula of Australia mentions his report is in two parts. Where his location is listed as Indonesia, those items were logged while on a trip to Indonesia from either Bandung, Java or Denpasar, Bali using a simple portable receiver with only the internal antenna. Unfortunately I misplaced the part of his note that named the equipment (MRL - 3/25/75)

#### DX LIMERICKS

I dialed slightly to the left, then right, The needle almost jumped out of sight, For at forty over nine, Burundi came in fine, (Alas, 'twas only a dream in the night!)	An eccentric DXer named Slaughter, Whose receiver was powered by water, Was never dejected, (As might be expected), When his light bill was only a quarter, (Jack Jones, Jackson, MS )
(Ed Ricchezza, Philadelphia, PA)	

# LOG REPORT - C 4-75

Frequencies: 11600 kHz up

Reports to: Jerry A. Lineback

Next deadline: 15 April 1975

P. O. Box 325

St. Joseph, Illinois 61873

- \*\*\*\*\*
- 11620 INDIA AIR; 2200 EE, nx, cmntry, local mx, poor (Zilmer 2-26)
  - 11650 CHINA RP; 2311 SS, YW tlk, poor (Bowsby)
  - 11672 PAKISTAN R Pakistan; 1300 EE, nx, local mx, poor (Zilmer 3-2); 1759\* EE, anced nx bull in GOS of RP and then off, strong and clear (Brunner)
  - 11685t CHINA RP; 0057\* sounded like EIR Anthem then off, poor (Trautschold 3-3)
  - 11695 CHINA RP; 0110 CC, M&W tlk, //11720 since 12-17 (Bowsby)
  - 11700 VATICAN VR; 1700-1715 EE tlk on holy year and Michaelangelo, FF ID at 1715, fair (Courtney); 2115 EE, rel nx, fair (Zilmer 3-8)
  - 11700 GERMANY (DR) RBI; 1255-1315 AA, AA mx, RBI IS at 1259 then more AA tlk & mx, see unid in 2/75 LR, good (Russell 3-7)
  - 11700 DOM REP R Clarin; 1830, 1915, 0026, SS, mx, ads, IDs, TCs, //4850, very good (McNeil, Navarre, Young)
  - 11705 FRANCE RFI; 1705 EE ID, interview by W, //11935, 15120, 15300, 1750 FF pops, time tone at 1800, poor-fair (Russell 2-26, Bowsby)
  - 11705 JAPAN NHK; 2315 CC, poor with strong beeping QRM, (Bowsby)
  - 11710 USSR RM Vladivostok; 2320 CC by OM under Unid (Bowsby) RAE?
  - 11710 UNID; to past 2330 SS by YW, often pauses, over RM, gone by 0110, fair (Bowsby)/
  - 11710 ARGENTINA RAE; 2330 EE, tlk abt Argentina as a world power, good-fair (Price)
  - 11715 ALGERIA RTVA; 2345 AA, chanting mx, //11810, 11965, fair (Zilmer 2-28)
  - 11720 INDONESIA JAVA RRI Jakarta; 0500, Indon, ex 11770?, (Willis-Australia 2-13)
  - 11720 CHINA RP; \*0100-0200 f/o CC, forign svc px, //11695 Bowsby, Davis)
  - 11720NF CUBA RHC; 1857 IS, opens in FF at 1900 over CBC North Svc, (Hauser 3-6)
  - 11725 VATICAN VR; 2358 IS into SS, 0015 SS, rel tlk, in Australia dominates over SLBC and NHK, (Hanner-Australia 2-28, Miller 2-23) schold 32)
  - 11725 UNID; 1800-1900\*, many langs, px of lite mx, tlk, fair, no IDs or IS hrd, (Traut/
  - 11725 CUBA RHC; 0233 EE nx, mx, \*0330-0333 ID, anthem, M&W nx, fair-good (T. Smith 2-27, Edelson 2-8)
  - 11730 MALAGASY REP RN; 2000-2120 EE, musical px, class mx, tlk, Tom Meyers Sunday px, poor-excellent (Brunner, Christie 2-9, Levy 2-17, Earhart 2-17); 1912 DD by radio to Africa, Neville Grey show, (McNeil)
  - 11730 HOLLAND RN; 2130, 2205, ex 5965, good (Slaff 3-8, Padula 3-4)
  - 11730 NETH ANT RN; 0650-0710 EE, to NZ, mx, tlk, poor/fade (Earhart 2-10)
  - 11740 SEYCHELLES IS FERA; 1700 mx, tlk, (Talbot 3-1)
  - 11740 MALAGASY REP RN; 1400 EE, Happy Sta. //15415, poor (Zilmer 3-2)
  - 11740 SRI LANKA VoA; 0115 EE under OAS, poor (Bowsby)
  - 11745 FRANCE RFI; 1521 FF, OM tlks, pops, var px, poor (Miller 3-1)
  - 11750 JAPAN FIN; 2340 pops, 2356 sports flashback and interview, ID 0000, weak, (Bowsby)
  - 11760 CUBA RHC; 1500 SS, tlk, mx, address, NA, //17705, 17735, 15230, 11960, all good (Edelson)
  - 11760 MOROCCO VoA Tangier; 1530-1600 Hindi nx and lang lessons, EE ID at 1600, v. good (Moritz 2-15)
  - 11765 BRAZIL R Tupi; 0003 PP song then OM mention of Sao Paulo, fair (Bowsby)
  - 11770 MEXICO R Mex; 1600, 0050, 0250-0300, SS, IDs, vocals, nx, possible NA at 0300, poor-good (Edelson, Brunner, Trautschold 3-3)
  - 11775 SPAIN RNE; 2200, 0010 SS, nx, poor-excellent (Bowsby, Buccola 2-28)
  - 11775 ETHIOPIA ETLF; 1955 EE, tlk abt North Sea Oil, ID at 2025, QRM, fading, but good (Slaff 2-26)
  - 11775 SAUDI ARABIA BSKSA Riyadh; 1500 AA chants and tlks, good since 3-2 (Behr)
  - 11780NF USA WYFR; 1855 IS, 1858 RR s/on, (Hauser 3-6)
  - 11780 NEW ZEALAND RN; 0530-0540, \*1600, EE, nx, poor-fair (Moritz 2-8, Christie 1-24)
  - 11780 ARGENTINA R Belgrano; 0127 SS, ID, sort of chopped, fair (Bowsby)
  - 11780 PHILIPPINES VoA; 2329, 0011 EE, nx, cmntry, fair (Ravenhorst 2-16, Bowsby)
  - 11780 BRAZIL R Nacional; 1005 SS nx, mx, 2215, 2100 EE to 2200\*, mx, features, 2201 into PP, IDs, fair-good (Lausevich, Padula-Australia 3-4, Zilmer 3-1, Earhart 2-17, Kusalik, Shingler 2-25, Jones 3-9, Buccola 2-28)
  - 11785 UNID; 1734 EE, tlk abt awards in Romania, communist-type sta, fair but blocked by AFRTS feeder at 1737, (Ravenhorst 3-9)
  - 11785NF MALTA CBC; 1800-1900 EE, 1900-2000 FF, ex 6110
  - 11785 NETH ANT TWR; \*2215, SS to Americas, NF this svce, (Padula-Australia 3-4)
  - 11785 BRAZIL R Guaiaba; 0004-0045 PP, ID, ads, Brazilian mx, tlks, poor-good (Trautschold 3-3, Brunner, Young)
  - 11790 NETH ANT TWR; 0300 SS, NF ex 11785 at 0015, (Padula-Australia 3-5)
  - 11790 INDONESIA RRI Jakarta; 2330 EE, nx, fair (Christie 1-24)
  - 11790 S AFRICA SABC; 1445-1455 EE, gold stocks report, fair (Mayer 2-17)
  - 11790 USA AFRTS Greenville, 2130 EE European feed, ex 6030, (Padula-Australia 3-4)
  - 11790 VATICAN VR; 1505 s/on in Asian Lang to SEA and India, fair (Price)
  - 11800 SRI LANKA SLBC; 1928-2005\* EE to Eu, Welcome to Sri Lanka Show, IDs, mx, Address, nx, (McNeil)

- 11800 CANARY IS RNE; 1525-1540 SS, ID at 1530 and mx, fair (Moritz 3-3)
- 11800 ETHIOPIA ETLF; 0602 EE rel px, ex 11865, (Hanner-Australia 3-2)
- 11805 USA WYFR; 2150-2245 GG to Eu, NF ex 6065, //9690, (Padula-Australia 2-21)
- 11805 USA VoA Greenville; 2140 RR to Eu, NF, (Padula-Australia 3-2)
- 11805 USA AFRTS Delano; Asian/Pacific feed at 0630, NF ex 6095, (Padula-Australia 3-4)
- 11805 SPANISH SAHARA R Sahara; 1110 SS, variety of SS mx, nx, into AA at 1231, fair (Miller 3-9); 1200-1800 fair to poor due to QRM, hrd RNE armt and mention of Aaiun, also mention of Las Palmas, Canarias one day at 1730; 1705 US mx, ID, RNE nx, sports, fair over RTB IS, until WYFR #1730 since 3-2 (Mayer); 1630 SS ID, pop mx, 1700 nx, 1708 SS ID, to 1800\*, over Belgium, fair (Behr 3-3).
- 11805 BRAZIL R Globo; 2345, 0130-0205 PP, US pops, ID, ads, nx, tlk, sports excerpts, fair to good (Trautschold 3-2, Lineback 3-5, Zilmer 2-26, McNeil)
- 11810 CHILE LVdeChile; 1230 EE, nx, cmntry, poor (Zilmer 2-22)
- 11810 AUSTRALIA RA Shepparton; relay of 8DR (Darwin) 0600-1000 NF ex 17715, (Hanner & Padula-Australia)
- 11810 ALGERIA RTVA; 2355 AA, chanting mx, fair (Zilmer 2-28)
- 11810 INDIA AIR; 1455 EE, nx, off at 1500, fair (Christie 1-19)
- 11815 USA WYFR; 2150 EE to Eu w/Back to God Hour, NF ex 11805, (Padula-Australia 3-2)
- 11815 BRAZIL R Brasil Central; 0315-0330 PP, mx, tlk, ads with fanfare, poor (Earhart)
- 11815 NETH ANT TWR; #0030 EE, ID, rel px, 1210 EE DX special, fair (Navarre 2-19, Zilmer 3-1, Trautschold 3-3)
- 11820 USSR RM; EE to Australia at 1220, ex 7380, (Hanner-Australia 3-5)
- 11825 VATICAN VR; 1503-1510 EE, into GG, nx, fair (McNeil)
- 11825 TAHITI R Tahiti; 0430, 0640-0700 FF, lite mx, tlk, poor-good (Earhart, Navarre)
- 11830 ETHIOPIA ETLF; 1800 Lang, werid IS, EE lessons 1810-1816, EE ID 1842 fair (Miller); 1945 EE, nx, record request px, anced 11840, good (Talbot 3-1); 2003-2030 EE, mx, tlk, ID, request for letters, fair-poor (Shingler 2-25, Earhart 2-17)
- 11830 ECUADOR HCJB; 0335 RR to Europe, NF ex 11835, (Padula-Australia 3-2)
- 11830 CLAND VoMalayan Rev; 0930 EE, tirade, new service, (Padula-Australia 3-4)
- 11835 FRANCE RFI; 0715, 0815 FF, to Africa, FF pops, //11845, (Hanner 3-3, Padula 3-1)
- 11835 SUDAN R Omdurman; 0440 AA drama, in clear as HCJB on 11830, (Padula-Australia 3-4)
- 11835 AUSTRIA ORF; 0635 GG, songs and amnts for East Asia, NF ex 11865, (Padula 3-2)
- 11835 HAITI R 4VEH; 1345 EE rel px, good (Navarre 2-19); 2220 SS rel px via long path (Padula-Australia 3-1)
- 11840 SWITZERLAND SBC; IS 0659, EE ID, NF ex 11870, to Australia, (Hanner & Padula-Australia 3-2)
- 11840 AUSTRALIA RA; 1504-1510 EE, nx, poor (Miller 2-16); also (Willis-Australia 2-11); \*1759 Waltzing Matilda, Anced 9580 to NZ, 11840 and 9540 to E Pac, and 9755, 9745, and 7270 to UK, very good, (Bowsby)
- 11840 ETHIOPIA ETLF; 1948-2000 EE nx, mx interlude, lang lessons at 2000, fair (Moritz); 2008-2030\* Rel px, ID, mx, (McNeil)
- 11850 LIBERIA VoA Monrovia; 2135-2200\* RR, nx, unusual mx, ID in EE as Monrovia, over RA, fair (Earhart 2-17)
- 11850NF USSR Asiatic, RM HS; 1000-1400+ no sign of Zambia (Willis-Australia 2-22)
- 11850 SWITZERLAND SBC; IS to 2300, ID and px in PP, mx, (Talbot)
- 11850NF CUBA RHC; 1835 FF, NF, good, nx, (Hauser 3-4)
- 11855 BELGIUM RTB; 2215 DD, gave freqs, W w/nx, good, 2255-2315 EE, Belgium Speaking, QRM from WYFR at 2300, fair (Slaff 3-8, Zilmer 2-26)
- 11855 USA WYFR; 2320 SS, M&W tlk, rel mx, fair (Trautschold 3-2)
- 11855 SEYCHELLES FEBA; 1843 AA, tlks, orch mx, fair (Bowsby)
- 11860s PHILIPPINES FEBC; spur at 11890-30kHz, (Hanner-Australia)
- 11863 ZAIRE R Lubumbashi; 1810 OM in Vernac, het RCI, fair (Bowsby)
- 11865 ETHIOPIA ETLF; 2015-2030 EE to W Af, rel px, ID, drums at s/off, good (Brunner)
- 11865 CANADA RCI; 1800-1900 EE to Afr, good, has LP echo, (Bowsby)
- 11865 ECUADOR HCJB; 2145 Swedish to Eu, 2159\*, ex 11740, listed on 55 but is on 65, noted day earlier than official starting date for period, (Padula-Australia 1-3)
- 11870 SWITZERLAND SBC; 2145 end of GG to Africa, into FF, QRMing Canada, (Slaff 3-8)
- 11875NF MONACO TWR; \*1520 RR, over R Liberty and Angola, (Willis-Australia 2-13)
- 11875 JAPAN NHK; 2305 CC, ex 7140, (Padula-Australia 3-2); 1254 RR, nx, amnts, ex 7140 (Hanner-Australia 3-2)
- 11875 PORTUGAL RP; 1815 EE, ID, fair, (Bowsby)
- 11880 TURKEY VoT; 2030 TT chants, good (Bowsby)
- 11880 MEXICO R Seis; 1455, 1800, 2242-2349 SS, tropical mx, IDs, sound effects, //15110 fair to good, (Shingler 2-27, Trautschold 3-2, Zilmer, McNeil, Navarre, Slaff)
- 11885 PAKISTAN R Pakistan; \*0500 in Sylheti to Mid East, NF, (Padula-Australia 3-4)
- 11895 NORWAY R Norway; 0740 NN to Pacific, ex 11850, good (Padula-Australia 3-3)
- 11895 USSR RM; Afr svc, ID, cmntry, nx, mx from 1506 to 1523, //12040, 12070, 9665, 11745 (Young)
- 11895 SENEGAL Rd Senegal; 2120 FF, tlk, QRM, poor-good (Trautschold, Navare 2-13)
- 11900 S AFRICA R RSA; 2100, 2227 EE, nx, ID, good (Navarre 2-16, Trautschold 3-2)
- 11905 ITALY RAI; 2200-2230 EE, nx, mx, good (Ravenhorst 3-7)
- 11905 USA UNR Greenville; \*2000, anced 11760 and 15410 only, QRM from RSA (Bowsby)
- 11910 UNID; 0010 rel tlk in lang, hymns, off in middle of mx at 0027 w/no ID, poor (Earhart 2-21)
- 11910 HUNGARY RB; 1752-1758\* EE to Eu, cmntry, rock mx, very good (Brunner)

- 11915 ECUADOR HCJB; 0239 EE, t1k, mx, excellent (T. Smith)
- 11915 LIBERIA VoA Monrovia; 1925 Albanian, Monrovia ID at 1930 then Romanian, (Bowlsby)
- 11920 USA VoA Dixon; 0305 EE to S Asia, now to 0330\*, good (Padula-Australia 3-5)
- 11920 IVORY COAST RTVI; 2045 FF, 1900-1958 EE t1k, mx, vocals, 2208 FF, ID, EE oldies, fair to good (Navarre 2-15, Trautschold 3-2, Shingler 3-7, Ravenhorst, Courtney)
- 11925 BRAZIL R Bandeirantes; 2330 PP, t1k, mx, jingles, ads, fair (Zilmer)
- 11925 CYPRUS BBC; 2010 WS, fair (Bowlsby)
- 11925 S KOREA RK; 0458 IS, ID by YW in KK and OM in EE, EE nx, good (Bowlsby)
- 11930 BELGIUM RTB; 1830-2000+ FF, fair (Bowlsby)
- 11935 PORTUGAL RP; 0230 EE, mx, t1k, very good (Navarre 3-8)
- 11935 FRANCE RFI; 1705 EE mixed with VoA, ID, interview, poor (Russell 2-26); 1752 EE sports report, last day heard, (Zilmer 3-1)
- 11935 BRAZIL RCGdeParanaense; 2315 PP, ID at 2329, fair (Zilmer 2-26)
- 11940 FRANCE RFI; 1745 EE, 1757 FF pops, //9520, 1850-1925 FF, 2100, 2135-2200\* FF, t1k, (Bowlsby, Zilmer, Earhart, Trautschold, Padula-Australia)
- 11940 KUWAIT RK; \*1700, time pips, EE ID, Anthem freqs, poor (Courtney); 1930 EE tent ID, t1k by W abt world trip, QRM, (Slaff 2-5)
- 11940 USSR RP; 1340-1400 EE, cmntry, good (Moritz 2-23)
- 11940 ROMANIA RB; 1315-1325\* EE, listeners club, fair (Zilmer)
- 11945 SPAIN RNE; 0200 SS, drama?, very good (Navarre 3-9)
- 11945 FRANCE RFI; \*1800 FF, mx, t1k, mx, //11940, fair (Zilmer 3-1); 1900 FF, mx, //11940, 11935, 11705, 9740, 9630, 9605 (Behr)
- 11945 CHINA RP; \*0000 IS, ID, EIR, nx, CC mx, (Edelson); 0045 EE t1k abt possible US-USSR attacks on China, fair (Slaff 2-10)
- 11945 ENGLAND BBC; 1215, V IS into EE ID, px in Hungarian, good (Courtney)
- 11950 LIBERIA ELWA; 1715 FF rel songs, 2000 Lang, 2015-2058 EE, Afro nx, rel px, poor-good (Price, Zilmer 3-1, Miller, Moritz, Buccola 3-2, Shingler, Trautschold, Jones, Ravenhorst)
- 11950 USSR RPP; 1355 EE to Asia, via LP with echo, ID, IS, at 1400, into lang (McNeil)
- 11950 BRAZIL R Min da Educaçao; 0126 PP amts, ID possible at 0130, //5990, (Young)
- 11955 ALGERIA RTVA; \*0600 AA amts, over BBC, (Willis-Australia 2-7)
- 11955 MALAYSIA BBC Tebrau; 0010 EE WS, VoA not on, good (Bowlsby)
- 11960 MALI RTM; \*0800 FF on sunday, //7110 (Willis-Australia)
- 11960 ISRAEL IBA; 2000 EE, nx, 0515 FF nx, \*2100 RR, IS, poor QRM from RHC, (Zilmer, Bowlsby, Hanner-Australia 3-4)
- 11965 BRAZIL R Record; 0232-0248, 0525-0550 PP, pops, ads, t1k, (Earhart)
- 11965 RWANDA DW Kigali; 1900 GG, poor, 2000 GG IS, ID, t1k, good (Bowlsby, Trautschold)
- 11965.9 ALGERIA RTVA; 1905 AA VoPalestine px, het Kigali, 1929 VoP ID followed by Algiers ID, fair (Hauser 3-6); 2350-0000\* AA chanting mx, fair (Zilmer 2-28)
- 11970 S AFRICA R RSA; 2230-2320 EE, px to NA, ex 15155, QRM from RHC, poor (Zilmer 3-3)
- 11970 AUSTRALIA RA; 0530 EE nx, very good (Bowlsby)
- 11978.5 GERMANY (DR) RBT; \*1530, EE drifting from nominal 11975, (Willis-Australia)
- 11990 CZECHOSLOVAKIA RP; 1805-1825\* EE, Afro-Asian svc, Mailbag, excellent, (Ravenhorst)
- 12015 CHINA RP; \*2330 CC, EIR, (Young)
- 12025 ISRAEL IBA; 2000-2055 EE, this freq was virtually useless in Jan and Feb until high power restored on 3-2, now good to exc, QRM, features and cmn try, (Hauser, Slaff 3-8, Ravenhorst)
- 12033 N VIETNAM VoV; Oriental mx, lang uncertain, VV at 2257, (Young)
- 12055NF ISRAEL IBA; 0505 HH HS relay, ex 12045 (Hanner-Australia)
- 12080 CHINA RP; \*1200-1255\* Khmer amts, //11695, 9900, 9440, 6520, (Willis-Australia)
- 12240 USSR Asiatic, Magadan; HS hrd here 1000-1200 (Willis-Australia 2-24)
- 14993 ENGLAND BBC; 1432 EE WS, same phase as 15070, seemed AM, but presumably feeder to relay, poor (Hauser 3-2)
- 15000 ARGENTINA LOL time sta; 2318 morse and voice ID in SS every 6 min, //10000, 5000 (Price)
- 15070 ENGLAND BBC; 1720 EE, Association Football, good (Miller 3-8)
- 15105 JAPAN NHK; 2202, 2300, 0400 EE, ID, nx, JJ at 2215, fair (Zilmer, McNeil, Hanner)
- 15105 HOLLAND RN Lopik; 0930-0950 EE to Far East, NF ex 15110, (Padula&Hanner-Australia)
- 15105 SWEDEN RS; 1307 Swedish, NF ex 9605 (Hanner 3-2)
- 15110 MEXICO R Seis; 2000, 0215-0245, 2200-0130, 0625, SS, Tropical mx, IDs, poor-excellent, (Brunner, Navarre, Talbot, Lausewich, McNeil, Edelson)
- 15110 USA WYFR; 1845\* EE, R Seis hrd after, (Jones)
- 15120NF MALAGASY REP RN; \*2000-2120\* EE, co Eu, ID, nx, ex 11730 (Behr, Zilmer 3-8)
- 15120 NIGERIA VoN; 1923-1930\* EE, nx summary, into FF, ID, fair (Ravenhorst 3-8)
- 15120 FRANCE RFI; 1700-1800 EE, nx, mx, cmntry, interviews, //15140, 15360, 15425, 15160, 11705, 11935, 15300, good (Russell 2-26, McNeil, Courtney 3-2)
- 15125NF? FRANCE RFI; 1730 EE, Paris Calling Africa, told of a slogan or motto contest, excellent, (Buccola 3-9) Miller
- 15125 PORTUGAL RP; 1530 PP, ID, class guitar, closing amts, IS, AP, fair-good (McNeil, / USA WYFR; 2355 SS, rel px, reed mx, (Slaff)
- 15130 USA WYFR; 2355 SS, rel px, reed mx, (Slaff)
- 15140 NETH ANT RN; 1640 DD&EE to 1650\*, //15190, both excellent, (Behr)
- 15140 SWITZERLAND SBC; \*1315-1345\* EE px cld With all due Respect, and SW Merry-go-round, good (Ravenhorst 3-9, Jones 2-22)
- 15145 SPAIN RNE; 2030 SS, music, t1k, excellent, (Navarre 2-16)

- 15150 CHILE LVdeChile; 2250 SS ID into AA, 0035, 1220, 2204 FF ID, then EE to 2232, 0233 EE tlk, IDs, cmntry, nx, poor-good (Navarre, Jones, Miller, Zilmer, Kusalik, McNeil, Talbot, Young)
- 15155 S AFRICA R RSA; 1856, 1940-2000 PP/EE, IDs, tlk, mx, FF at 2000, fair (Earhart 2-17, Jones 2-17)
- 15155 PORTUGAL RP; 0905 PP, xed RFI, new time this freq, previously opened at 1000, (Padula-Australia 3-2)
- 15155 AUSTRIA ORF; \*1600 GG, nx by M, fair (Mayer 3-8)
- 15160 FRANCE RFI; 1515 EE to Africa, IDs, good (McNeil 2-22)
- 15160 HUNGARY RB; 1130-1200\* Ital and Greek, also sunday 1400-1600\* Hung, one of the new 250 kw tx at Jaszbereny. (name not given)
- 15160 AUSTRALIA RA Lyndhurst; new \*2100 EE, ex \*2200, (Hanner-Australia 3-2)
- 15160 MEXICO XEW; 1400 SS nx, 1900 mention of Cadena RASA, this freq active sporadically, never very strong compared to 15110, 1900 SS tlks to 2130, fair (Hauser 3-7, Behr)
- 15165 FRANCE RFI; 1700-1745 EE, Paris Calling Africa, nx, mx, fair to good (Hauser, Brunner, Shingler, Courtney, Jones)
- 15170 TAHITI RT; \*1900-1907\* EE South Pacific Bulletin, otherwise FF, 0345-0400 FF and beautiful Polynesian mx, 200-2005 SS nx, 1600 FF, 0330 FF/Tahitian, poor-good, (Ravenhorst, Brunner, Talbot, B. Davis, Moritz, Jones, Christie, Navarre)
- 15180 USSR RM; 2300 EE, nx, cmntry good (Navarre 2-20); R Yerevan to NA in Armenian, 0300, (Padula-Australia 3-2)
- 15185 USA WINB; 2137, 2203 EE, rel px, ex 11775, (Padula & Hanner-Australia 3-2)
- 15185 USSR RM; 0735 Indon, NF, (Padula-Australia 3-1)
- 15185 FINLAND RF; 1427-1445 EE, nx, features, 1530 IS, time pips, into Fin or Swed, fair (Zilmer 3-8, Courtney, Jones 2-22, Lausevich)
- 15190 ETHIOPIA ETLF; 1545-1600 Farsi, rel tlk, fair, fade (Mayer 2-17) Miller)
- 15190 BRAZIL R Inconfidencia; 2140-2252 PP, tlks, variety px, ads, fair (Kusalik, /
- 15220 S AFRICA R RSA; 0520 FF to Cent Afr, NF ex 17780, xed USSR, (Padula 3-4)
- 15240 JAMMER; 1825 "PB" grinder, IBA not sched til 1830 and then to S Afr, not USSR, (Hauser 3-4)
- 15240NF ECUADOR HCJB; 1330-2130 SS to SA, ex 17720, weaker than //15265, (Hauser and?)
- 15245 ZAIRE Kinshasa LVduZaire; 1938-2038, 2230, political tlks in FF, mx, nx, variety px, good (Navarre 2-16, Kusalik 2-20)
- 15245 GERMANY (FR) DW; \*0700 with new service in Bengali, //17825, (Padula-Australia 3-1)
- 15250NF MALAGASY REP RN Talata; 1830-1950\* AA, good, ex 11955, (Behr)
- 15255 USSR RM; 0240 CC svce, (Padula-Australia 2-22)
- 15255 NETH AMT TWR; 1230-1245 EE, childrens px, fair (Earhart 2-15)
- 15260 JAPAN FIN; 0235 with relay of sports event from APRTS, //15330 Delano, not often hrd in local daytime, (Padula-Australia 2-22)
- 15260 ASCENSION IS BBC; 1958 with ID as Atlantic relay to Americas, 2000 nx, gave freqs, same as 9510, excellent (Brunner 2-28)
- 15260 HOLLAND RN Lopik; 1830-1950\* EE px, weak, ex 11730, (Behr)
- 15265 SWEDEN RS; IS into FF px at 1330, QRM from Talata, NF ex 11705, (Hanner-Australia)
- 15270NF ECUADOR HCJB; moved here from 15265 at 1900-2130 because of QRM from BBC-A, now QRM from VoA Polish at 1900, (Hauser)
- 15270 JAPAN NHK; 2302 to NA, nx, ID, mx, fair (McNeil)
- 15280 NEW ZEALAND RNZ; 0500-0515 live sports, fair //15110, (Mayer 2-20)
- 15280 USA KGET; 2348 SS, rel px giving a po box in Bogota, ID, lots of noise and fade, poor (Slaif 2-13)
- 15290 PHILIPPINES VoA; 2244 EE, breakfast show, good (Miller 3-3)
- 15290 ARGENTINA R El Mundo; 0000 SS, very good quality mx, dance and semi-class, fair (Zilmer 2-19)
- 15290 AUSTRALIA RA-S; 0500 Mailbag in EE, African px retimed now to 0400-0530 EE and 0530-0630 in FF, (Hanner-Australia 3-2)
- 15290 GREECE VoA Kavala; 1555-1605 EE, nx in special EE, tlks, ID, poor (Shingler 3-1)
- 15300NF JAPAN NHK; 2345-0045 EE to ENA, ex 11725, //15270, poor due to FEBC (Hanner 3-2)
- 15300 BABEL; Too many on this freq after spring changes, at 1500 hrd VoA, RHC, RFI, and jamming, (Hauser 3-2)
- 15300 FRANCE RFI; \*1700-1730 EE to Africa, //11705, 15165, 11935, 15120, poor, 1330 FF above VoA RR, (Price, Hanner, Talbot, Russell)
- 15300 ECUADOR HCJB; 1800-2200 EE to EU, NF ex 15305, clears that freq for Malta, RFI QRM, (Hauser and credit lost)
- 15305 MALTA RCI; \*1800 used even before spring changes, Afr relay, //15325-S, fair, 1800-1900 EE, 1900-2000 FF, (Hauser and credit lost)
- 15315 ECUADOR HCJB; 1745 EE, now moved to 15310, fair (Hauser)
- 15320 MALAGASY REP RN Talata; 1100 DD to SEA, NF ex 15110, strong, (Hanner & Padula)
- 15320 AUSTRALIA RA; 0130, 0220-0235 EE, mx, nx, good-excellent, (Brunner, Navarre 2-17)
- 15324.5 PAKISTAN R Pakistan; 0300-0345 in Swahili, //17830, 21590, (Willis-Australia 2-24)
- 15325 JAPAN NHK; 0641 Swedish, ex 15430, xed Pakistan (Hanner & Padula-Australia 3-2)
- 15345 GREECE EIRT Athens; \*1400-1455 Greek, VoA off, ex 15435, (Hanner-Australia 2-8)
- 15345 NORWAY R Norway; 1620 NN, mx, EE ID at 1623, mention of Sunday EE px, fair (Mayer)
- 15355 AUSTRALIA RA-S; 2338 FF, NF ex 15400, (Hanner-Australia 3-2)
- 15360 FRANCE RFI; 1700-1730 EE, nx features, good, //15300, 15165, 15140, 15120, 11940, 11935, 11705 (Buccola 3-2, Behr); 1515 FF/EE ID as Radio France, then IS and annt for French Broadcasting Corp., nx in FF then EE, poor (Herbold 3-7); 1328 FF cmntry,

- under USSR, (Hanner 2-8)  
 15360 USA VoA Greenville; 2220 FF to Africa (Padula-Australia 3-4)  
 15365 CANARY IS RNE; 0435 SS relay, only occasionally hrd, (Willis-Australia 2-17)  
 15365 CANADA BBC-S; now \*1600-1709\*, now poor, 50kw to Caribbean (Hauser 3-2, Talbot)  
 15370 JAMMER; 1613 "BR" grinder, ID twice, against R. Liberty, (Hauser 3-4)  
 15388NF CHINA RP; 0300-0355 RR, //15118, (Willis-Australia 2-13)  
 15390 PHILIPPINES FEBC; 0100 Indon, fair (Bowlby)  
 15390 JAPAN NHK; 0640 Swedish to Eu., NF ex 17835, (Hanner & Padula-Australia 3-2)  
 15390 VENEZUELA R Nac; 2322 SS, Fine Venez mx, ID by YW, good (Miller 3-3)  
 15395 AUSTRALIA RA-S; 2300-2333, 2213, 0227 EE, nx, mx, fair-poor (Hanner-Australia, Miller 3-3)  
 15400 AUSTRALIA RA-S; 2300 EE, nx, poor (Zilmer 3-3)  
 15405 AUSTRALIA RA-S; 2313 EE World of mx, NF ex 15400, (Hanner-Australia 3-2)  
 15405 ECUADOR HCJB; 1330 EE, rel px, //15115, excellent (Navarre 2-19)  
 15410 RWANDA DW Kigali; 2337 GG, cmtry by YW, poor (Miller 3-4)  
 15415 HOLLAND RN Lopik; 1500 EE, Happy Sta px, fair (Zilmer 2-16)  
 15415 KUWAIT RK; station reported in Feb LR is Kuwait at 0815, //21685, ID at s/on, BSKSA is still on 15145 to 0900\* rechecked, (Willis-Australia 2-12). Thanks.  
 15425NF FRANCE RFI; 1700 EE, 2000-2100 EE, Paris Calling Africa, 2000 // 15300, 15360, 11940, 17725 (Zilmer 3-8, Hauser)  
 15425 AUSTRALIA VLW15 Perth; 2245-2300, 2344 EE, ABC nx, west Aust nx, local time, poor to fair (Miller 3-3, Mayer 2-17)  
 15425 SRI LANKA SLBC; 1605 BBC WS nx relay, //Cyprus 15420, ID at 1609 and said that next nx relay would be at 0200, fair (Hauser 3-4)  
 15425 GREECE EIRT Athens; 1257-1355 Greek, bad QRM from DW and RM, (name lost)  
 15430 USA AFRTS Greenville; 2200 Eu feed, NF ex 11935, (Padula-Australia 3-4)  
 15440 PHILIPPINES FEBC; 2330-2339 EE, nx, cmtry, poor-fair (Zilmer, Miller 3-3); 0045 CC rel px, fair (Bowlby)  
 15445 ENGLAND BBC; 1544\* RR, Govorit London, good (Hauser 3-3)  
 15485 ISRAEL IBA; 1450 RR, NF fairly free of Jammers, (Willis-Australia 2-10)  
 17665NF PAKISTAN R Pakistan; \*1215 Urdu (Willis-Australia 2-9)  
 17690 ISRAEL IBA; 1544 Yiddish, jammed, fair (Hauser 3-7)  
 17700 USSR RM; 1000 EE to Asia, ex 17870, (Hanner 2-16)  
 17705 CUBA RHC; 2130 EE nx, cmtry, good (McNeil)  
 17715 AUSTRALIA RA-S; 0120 EE, 0330 VV, ex 17795 (Hanner-Australia)  
 17715 FRANCE RFI; \*0858 FF to Africa, xed Shepparton relay of 8DR, (Padula 2-22)  
 17715 AUSTRALIA RA-S; 0245 EE, NF, (Padula-Australia 3-2)  
 17720 FRANCE RFI; 1712 EE to Africa, very poor in QRN, (Slaff 3-9)  
 17730 MALAGASY REP RIM; 1523-1603\* EE international svce, musical selections, ID, tlks by woman, good (Kusalik 2-20)  
 17730 ECUADOR HCJB; 1630-2030 EE, rel px, to Eu, good (Trautschold, Slaff 3-2)  
 17740 AUSTRALIA RA-S; 0100-0700 EE, NF ex 15400 (Hanner, Padula-Australia 3-2)  
 17765 RWANDA DW Kigali; 1230-1240 EE, tlk abt West German/Israeli relations, fair (Earhart 2-28)  
 17765 USA AFRTS Delano; 0250 to 0400\*, Asia/Pacific, (Padula-Australia 3-5)  
 17775 USA WINB; 1740 EE, rel tlk, mx, bad modulation, poor (Miller 2-16)  
 17775NF USSR R Yerevan; 0300 Armenian, EE at 0325, (Padula-Australia 3-2)  
 17775NF ROMANIA RB; 0642 IS, into EE to Aust/NZ, ex 17850, (Hanner-Australia 2-17)  
 17780NF MALAGASY REP RN; 1250 DD, ex 15265 to avoid Stockholm (Hanner-Australia 3-2)  
 17800NF ENGLAND VoA Wofferton; 1302 RR, additional NF, (Hanner 3-2)  
 17810 FRANCE RFI; 0928 FF, //15155, not Belgium (Willis-Australia)  
 17810 PHILIPPINES FEBC; 0045-0100\* hymns, EE anmts, IS, fading, (Hauser 2-14)  
 17820 AUSTRALIA RA-S; 0442 EE, world of mx, resched to Afr, FF now 0530-0630, (Hanner)  
 17830 SRI LANKA SLBC; new JJ svce at 1100, //15120, 11835, dont know if permanent (Willis-Australia 2-10)  
 17880 ECUADOR HCJB; 1535-1540, nx, rel px, (Edelson 1-13)  
 17880NF JAPAN NHK; 0705 EE nx, NF ex 15195, (Hanner-Australia)  
 17885 CUBA RHC; 2047 good, Cuban mx, IDs in EE, (McNeil)  
 17888- PAKISTAN R Pakistan; 0515-0532 Urdu, nx, QRM from Shepparton relay of 8DR, //17830,  
 17890 21590, possibly replaces 17910, (Willis, Hanner); 0840 national songs, 1100-1115 EE nx at dictation speed, (Padula-Australia)  
 17890 AUSTRALIA 8DR relay from Shepparton; 2358, 0517, ex 17715, Cricket cmtry, (Padula 3-1, Hanner 3-2 both Australia)  
 21535 S AFRICA R RSA; 1515-1530 FF/EE/Swahili, music by orch, tlk, fair (Earhart 2-13)  
 21620 ISRAEL IBA; 1117 RR svce, poor, jammed, (Hanner 2-8)  
 21625 USSR RM; 0845 CC, (Padula-Australia)  
 21635 NETH ANT RN; 1725-1803 DD, songs, instrumentals, occ. QRM, fair (Earhart 2-10)  
 21720 PAKISTAN R Pakistan; 0730 lang, //21590, (Willis-Australia 2-16)  
 21725 AUSTRALIA RA-S; 0332 VV, ex 21485, (Hanner-Australia 3-2)  
 21730 ASCENSION IS VoA; 1359\* SS, confirmed, (Hauser)  
 21745NF USSR RM HS; 0700-0800 RR, NF, (Padula-Australia 3-1)

A single contributors list is being compiled at headquarters this month, so the comments I made last month regarding receiver notations will be done to suit DF. I do suggest, however, that it will be a good idea if each of us clearly indicates the make

and model of our receivers in our reports so there will be no confusion. Also, please please put your surname after each item. I forgot to correct this omission in one set of reports this month and somebody lost his credits.

Solar activity continues to decline and it is difficult to pick a peak. Solar activity picked up about March 2 and continued through March 19. The average activity was less than the previous month, yet several periods of active geomagnetic disturbances were noted. These took place on February 24, March 6, and March 10-11. The A-index reached 40 on March 11, the highest since last October. I don't know if there was good DX during that time as I was out of town. Another low peak in solar activity may occur about the last of April with high geomagnetic field activity a few days before and after.

One possible way to satisfy your curiosity regarding propagation conditions and reception conditions is to use your receiver S-meter to measure signal strengths of known stations and plot this on a graph with the A-index or solar activity. Graphs shown below were constructed by monitoring a set group of stations daily at a set time. Signal strengths as indicated by the S-meter and the ambient noise level varied from day to day. The same antenna/receiver set up was used each time. These data are plotted on the graphs along with the A-index. Monitoring was at 0300-0400 and involved mostly easy to hear Central and South American Stations in the 60m band. You can draw your own conclusions. In one case reception to the south appears to be enhanced by a high A-index, in the other the reception appears to be depressed. These variations probably occur because of changes in the strength and height of the ionospheric F and E regions in the equatorial zone. They also show the difficulty of making generalizations about propagation conditions for good reception on a particular path.

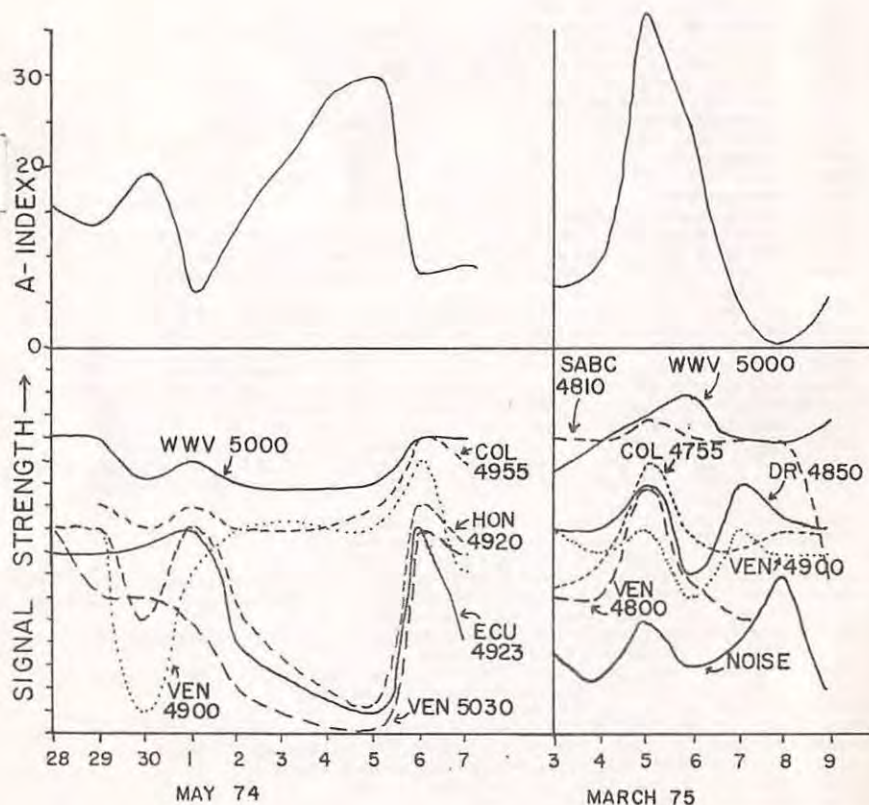

BARTO, Sam, Watertown, CT - BC794  
 BEHR, Ernie, Ottawa, Ontario, Canada - SPR4/ XCR30  
 BOWLSBY, Jeff, Vancouver, B.C., Canada - SP600  
 BRUNNER, Charles H., Jr., Salford, PA - D7000Y  
 BUCCOLA, Gary, Dixon, Ill., Hammarlund HQ129X  
 BROWN, David E., Bridgeport, WV - Globe Traveler 7000  
 CHRISTIE, James, Winnipeg, Manitoba, Canada - HQ129X  
 DAVIS, Bill, Laguna Niguel, CA - Homebrew  
 DAVIS, Jim, Travis AFB, CA - SX99  
 EARHART, Kenneth A., Allentown, PA - SX190/DX150A  
 ESTES, Steve, Newport News, VA - SX190  
 EDELSON, Michael, Cedar Grove, NJ -  
 FIELD, Marlin A., Hillsdale, Michigan, - SX100  
 FIELDS, Tony, Pottage, Michigan - DX150A/TRS-26/S-38E  
 FINKO, Henry E., Rochester, NY - 1936 RCA VICTOR Console  
 HANNER, Robert, South Cauldfield, Victoria, Australia (Trio 9R99DS)  
 HAUSER, Glenn, Enid, Oklahoma, - HQ160  
 HERAGHTY, George, Ronkonkoma, NY -  
 HERBOLD, Agnes, Linwood, CA - SX190  
 HILL, Bob, Berkeley, CA - R390A/R390  
 JONES, Jack R., Jackson, MS - DX150A  
 KUSALIK, Edward, Chatham, Ontario - Collins R388/HQ129X  
 LAUSEVICH, Arnold J., Millwaukee, WI - DX150B  
 LEGGE, Roger, McLean, Virginia  
 LEVY, Brian E., Atlanta, GA - DX160  
 LINEBACK, Jerry A., St. Joseph, IL - SPR4/XCR30  
 MARGUS, Leslie, St. John, N.B., Canada - SW4A  
 MAYER, Alan, Park Forest, IL - SPR4/DX150B/ NCL173  
 McCARTHY, Dan, Terre Haute, IN - DX160/WR600W  
 McCOY, Bob, Lincoln, NE - DX150B  
 McNeil, Pitt, Washington, D.C., - DX160  
 MILLER, Albert A., Jr., Youngstown, Ohio - HRO-500  
 MORITZ, John, Jr., Youngstown, Ohio - DX160  
 NAVARRE, E.C., Mesquite, Texas - SW4A  
 NEERON, Larry, Daly City, CA - SX190/Sanyo  
 Padula, Bob, Surrey Hills, Victoria, Australia (Marconi CR100)  
 PADULA, Bob, (traveling in Indonesia), CR100  
 PATTERSON, Carroll R., Decatur, GA - SX99  
 PERDUS, Neal, Millington, TN - 2C/SW4A  
 POWERS, Jeffrey R., Conemaugh, PA - DX150B  
 PRICE, Bryan, Lexington, KY - DX150B/NCL83  
 RAVENHORST, Greg, Clarks Grove, Minn., - R4C  
 REEVES, Scott, Laurel, MD - SX190  
 ROCKWOOD, Henry, St. Clairsville, Ohio - XCR30  
 RUSSELL, W. Keith, Urbana, IL - SX100  
 SHINGLER, Dan, St. Clair Shores, MI - DX160  
 SLAFF, Jerald, Brooklyn, NY - KTR-1665  
 SMITH, Todd, Wilton, CT - GR64  
 SPARKS, Bill, San Francisco, CA - R390A/R4B/HQ180A  
 SZOT, Kevin, Vacaville, CA - NCL83D/CRM-R6A  
 TALBOT, Larry, Menomonee Falls, WI - SB313  
 TOBIN, Pat, McDonald, PA - DX160  
 TRAUTSCHOLD, John, Menomonee Falls, WI - SB310  
 TUCHSCHERER, John, Neenah, WI - HQ100A  
 WHITACRE, Bill, Lansing, MI - R4B/SX96  
 WILLIS, Michael, Hampton, Victoria, Australia - Trio 9R99DE  
 YOUNG, James W., Wrightwood, CA - HQ180  
 ZILMER, Robert, Milwaukee, WI - SPR4

Our thanks to those who, month after month, supply the loggings to LOG REPORT.

